

DIN W48×H24mm, Indication Only, LCD Display Pulse Meter

■ Features

- Upgraded version of LR7N series
- Easy of 1 pulse input method per 1 revolution
- Display up to 10000RPM
- No need power supply by internal battery
- Protection structure IP66 (front panel only)
- Displays RPM, RPS of rotor
- Displays AC line frequency



⚠ Please read "Safety Considerations" in the instruction manual before using.

■ Ordering Information

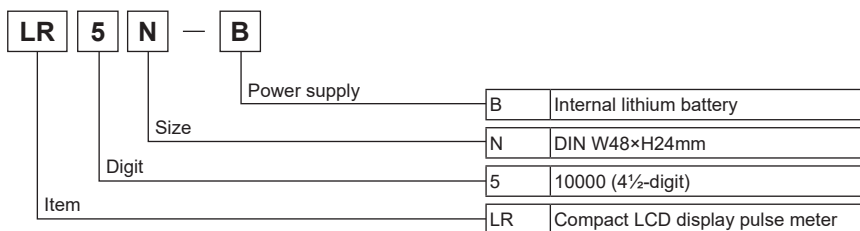

■ Specifications

Model	LR5N-B		
Input method	No-voltage input	Voltage input 1	Voltage input 2
Input signal level	Short-residual voltage : max. 0.5V Max. short-circuit impedance : max. 10kΩ Max. open-circuit impedance : min. 500kΩ	DC	Voltage: 30-240VAC~
		AC	
Power	No-power [includes lithium battery (replaceable)]		
Battery life cycle	Over 3 years at 20°C (replaceable)		
Display method	LCD Zero blanking method (character height: 8.7mm)		
Display digits	4½-digit		
Display range and Display accuracy	Display range		Display accuracy
	RPM	1 to 10000RPM	1 to 5000RPM: F.S.±0.05%±1-digit 5001 to 10000RPM: F.S.±0.1%±1-digit
	0.1RPM	0.1 to 1000.0RPM	F.S.±0.05%±1-digit
	Hz	1 to 1000Hz	F.S.±0.1%±1-digit
	0.1Hz	0.1 to 100.0Hz	
RPS	1 to 1000RPS		
HOLD function	Includes (external HOLD function)		
Insulation resistance	Over 100MΩ (at 500VDC megger)		
Dielectric strength	2,000VAC 50/60Hz for 1 min (cutoff current=10mA)		
Vibration	Mechanical	0.75mm amplitude at frequency of 10 to 55Hz (for 1min) in each X, Y, Z direction for 1 hour	
	Malfunction	0.3mm amplitude at frequency of 10 to 55Hz (for 1min) in each X, Y, Z direction for 10 min	
Shock	Mechanical	300m/s ² (approx. 30G) in each X, Y, Z direction for 3 times	
	Malfunction	100m/s ² (approx. 10G) in each X, Y, Z direction for 3 times	
Environment	Ambient temperature	-10 to 55°C, Storage: -25 to 65°C	
	Ambient humidity	35 to 85%RH, Storage: 35 to 85%RH	
Protection structure	IP66 (when using waterproof rubber for front panel), terminal cover (finger protector)		
Weight ^{※1}	Approx. 91.5g (approx. 59g)		

※1: The weight includes packaging. The weight in parenthesis is for unit only.

※Environment resistance is rated at no freezing or condensation.

SENSORS

CONTROLLERS

MOTION DEVICES

SOFTWARE

(J) Temperature Controllers

(K) SSRs

(L) Power Controllers

(M) Counters

(N) Timers

(O) Digital Panel Meters

(P) Indicators

(Q) Converters

(R) Digital Display Units

(S) Sensor Controllers

(T) Switching Mode Power Supplies

(U) Recorders

(V) HMIs

(W) Panel PC

(X) Field Network Devices

■ Connections

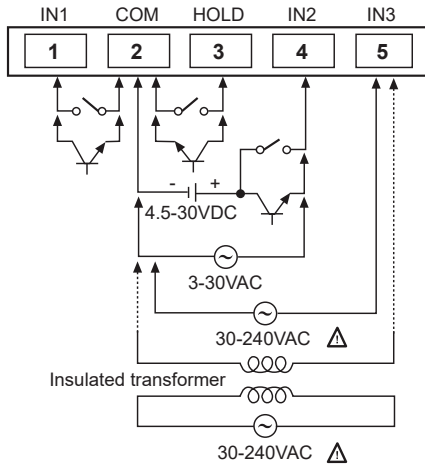

※Please use reliable contacts enough to flow 5μA of current when using input signal or reset signal as a contact.

※IN1 - No-voltage input

- IN2 - Voltage input
 - DC voltage input
 - AC voltage input: Display AC frequency.
- IN3 - AC voltage input: Display AC frequency.

※Select one input among IN1, IN2, IN3.

⚠Caution for IN3 input

When supplying high voltage over 50VAC into IN3, use the isolation transformer with 1:1 turn ratio or set up the counterplan, or it may cause electric shock.

※Use terminals of size specified below.

	a	b
	Min. 3.5mm	Max. 7.0mm

■ Operation Charts

● Setting RPS, Hz

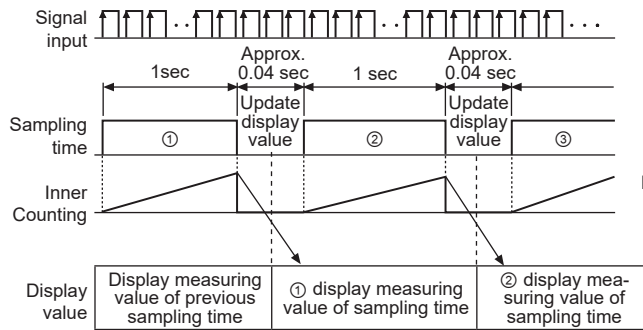

● Setting RPM 0.1, RPM 0.1Hz

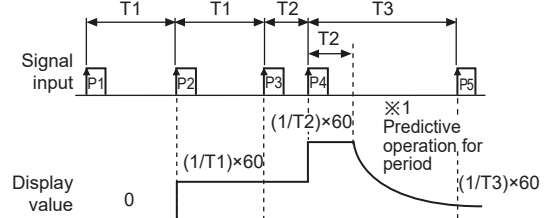

※1: It implements Predictive operation for period without Auto zero time setting function (If there is no pulse input within setting time, it displays the value as zero forcibly). If there is any input signal within certain time (T2), CPU considers input to be supplied, display value is decreased continuously.

■ Operation Mode (Frequency/Revolution)

◎ Frequency (Hz, 0.1Hz) = f, Revolution (RPM, 0.1RPM) = f × 60, Revolution (RPS) = f

● Revolution

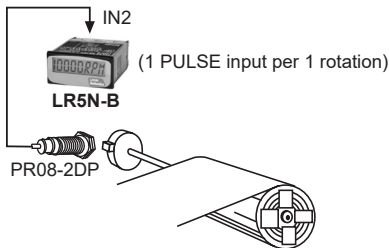

● AC frequency

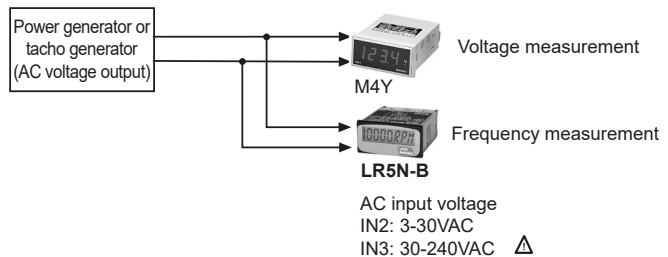

● Display value and unit

Display	Frequency		Revolution		
Unit	Hz	0.1Hz	RPM	0.1RPM	RPS (factory default)

Compact LCD Display Pulse Meter

(unit: mm)

■ Dimensions

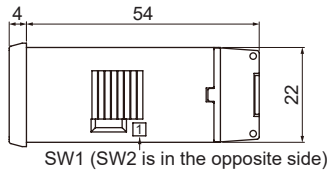
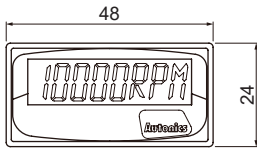

● Bracket

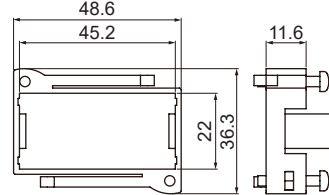
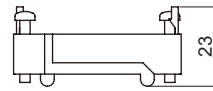

● Panel cut-out

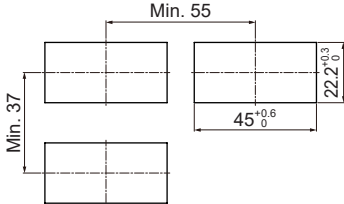

■ Input Connections

- Standard input sensor
- : NPN open collector output type

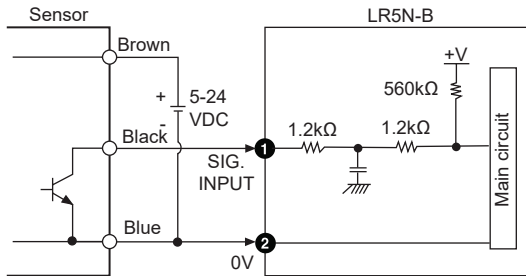

■ Function

● RESET

It initializes an unit and front LCD display. There are not indicated when set switch1 as RESET.

● HOLD

It stops display value by short circuit HOLD terminal when it is hard to read the value because of frequent input changes.

■ Display Range Selection

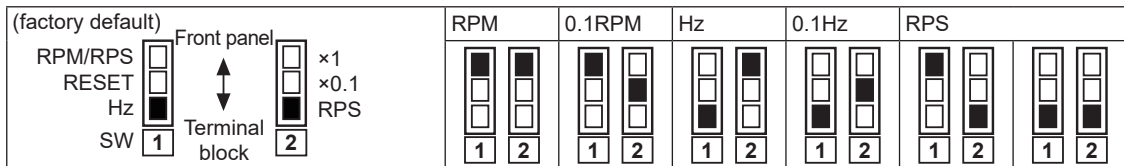

① Select one among ×1, ×0.1 and RPS by SW2.

② Shift SW1 to RESET.

③ Select one again between RPM/RPS and Hz by SW1.

※When display range and unit in front display panel do not conform, move SW 1 to RESET and select RPM/RPS or Hz again.

■ Battery Replacement

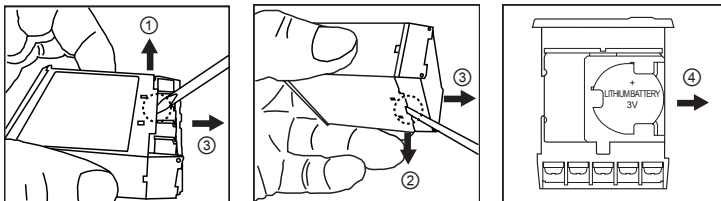

1. Pulling terminal towards ③ direction, raise Lock part towards ① and ② direction with the tool to remove case.

⚠ Please be careful of the injury from the tool.

2. After removing case, gently press the battery towards ④ direction to remove the battery.

3. Check the polarity of the battery and insert it in reverse order.

※Battery is sold at retailers, and replacement is on user. (sold separately)

※Do not burn or disassemble the lithium battery.

※Do not solder, charge, or modify the battery.

※Do not heat the battery.

※Before discarding the battery, insulate the positive pole and negative pole with the insulating tape.

SENSORS
CONTROLLERS
MOTION DEVICES
SOFTWARE

(J) Temperature Controllers
(K) SSRs
(L) Power Controllers
(M) Counters
(N) Timers

(O) Digital Panel Meters
(P) Indicators
(Q) Converters

(R) Digital Display Units
(S) Sensor Controllers

(T) Switching Mode Power Supplies

(U) Recorders

(V) HMIs

(W) Panel PC

(X) Field Network Devices
