

Web-based HMI
Programmable Display
WH SERIES



Add “IoT” to machines with the displays
Ready for Industrial IoT



WHA1	Advanced model	21.5 inch	15.6 inch	10.1 inch	7 inch	5 inch
WHS1	Standard model	10.1 inch	7 inch	4.3 inch		

Providing new information to the production site with web technology

Operation panels

Programmable displays in the past were used to operate machines and display information at the production site

FROM 



■ Previous issues

Machine status
visible only
at the production site

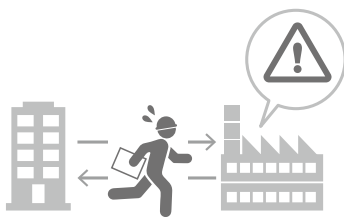

A visit to the production site was required every time to check the machine status.

Information displayed
on indicator
must be transcribed

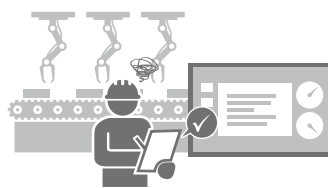

The operator has to regularly transcribe the production results of the equipment to the ledger.

Production information
were manually
converted into data

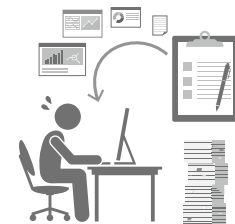

Information of production results written by hand had to be entered manually into an office PC.



■ Features of the information panel

Production site can be checked from **anywhere** with a browser

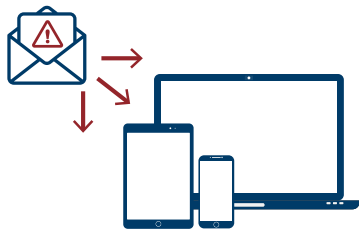

You can check the machine status via PC and smartphone without going to the production site. Details of the problems that occur can be checked with notification e-mail sent automatically.

Data can be **automatically** transcribed

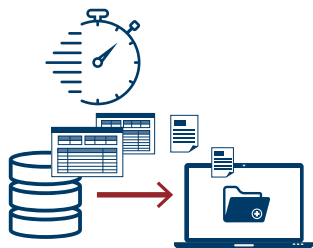

Equipment and production records and daily reports that used to be handwritten can now be automatically converted to data. Total work hours can be reduced, and omissions and mistakes can be prevented.

Production information can be **automatically** stored in higher-level systems

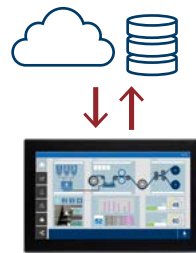

The data collected by the **WH** series is automatically stored in higher-level systems such as databases and on the cloud.

Display connects the PLC to higher-level systems without programming

The **WH** series supports various communication protocols and can be used as a gateway to connect lower-level control systems to higher-level information systems without programming.

Connection with various higher-level systems

The **WH** series supports OPC UA client/server, MQTT and SQL, etc., and can be connected to higher-level systems such as databases, file servers and various cloud services without programming. The **WH** series can be used as a gateway to existing equipment for data communication with high security using OPC UA^{*1} and data analysis using various cloud services.



Office PC
(Web browser)

Information system

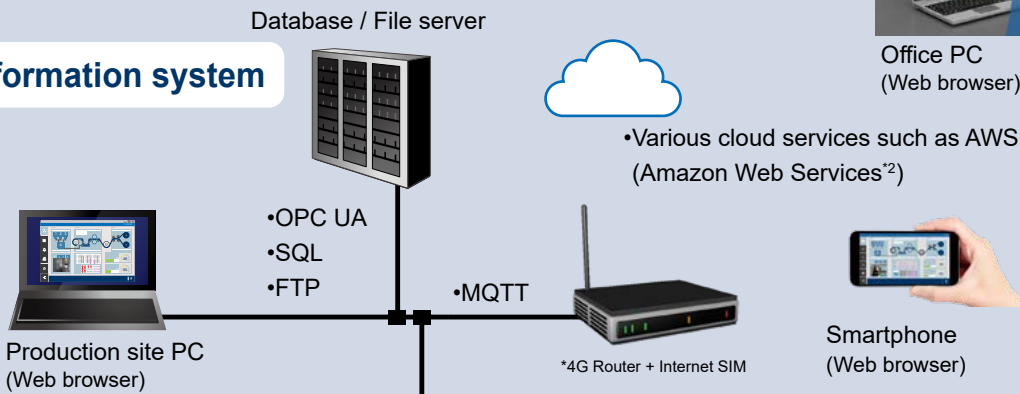

Display as a gateway



*1: The OPC Unified Architecture (UA) is a secure, reliable and open data communication standard developed by the OPC Foundation and internationally standardized as IEC 62541.
*2: Amazon Web Services is a trademark of Amazon.com, Inc. or its affiliates in the United States and other countries.

Control system

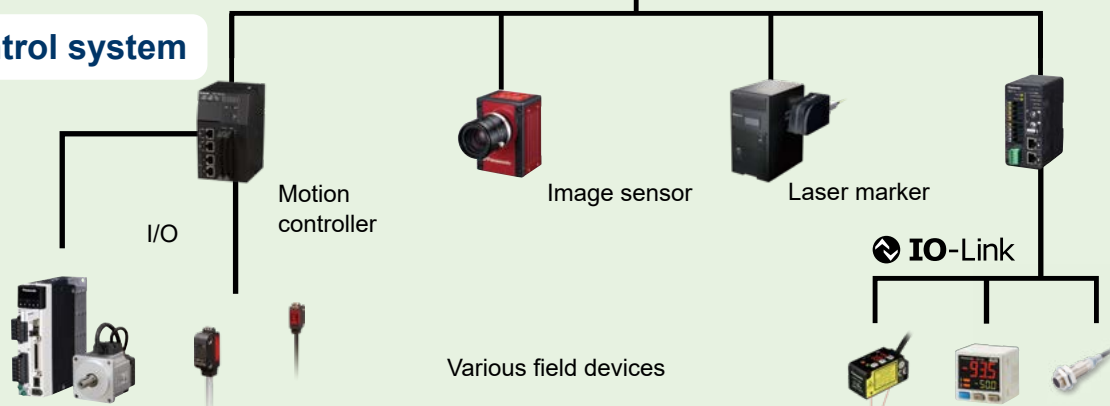

Programming-free connection to PLCs of different companies

Able to handle communications protocols used by various PLCs. Naturally, the gateway can be implemented when you install new equipment, but it can also be used to connect existing equipment. By simply replacing the display on newly installed equipment and, even, legacy equipment you can remotely visualize the status of field devices.

*Please refer to "Supported protocols" on page 11.

Simultaneous connection to different communication protocols

The advanced model can connect using a total of 8 different communication protocols (**AWHA1C050**: Up to 4 different communication protocols), and the standard model can connect using as many as 4 different protocols. Data can be transferred between multiple PLC models without programming.

Supports IoT conversion / data utilization of equipment

Web server function

Visualization of the operational status of existing equipment

Information on equipment operations can be collected from PLCs of existing equipment without programming. The web server functions can be used to check the operational status of equipment and identify bottlenecks from the office.

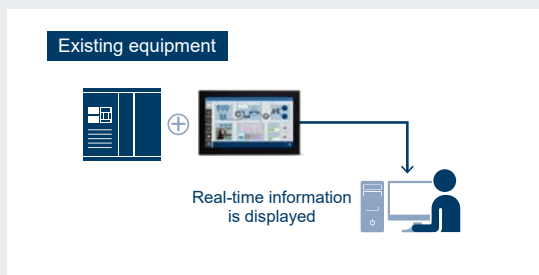

Connection with higher-level systems

Connect to database / cloud services

Equipment information can be connected to databases, cloud services and other higher-level systems without using PC and programming*.

The display can be used as a gateway to lower the cost of introducing IoT.

* Programming with JavaScript may be required in some cases. JavaScript is a registered trademark of Oracle Corporation and its subsidiaries and affiliates in the United States and other countries.

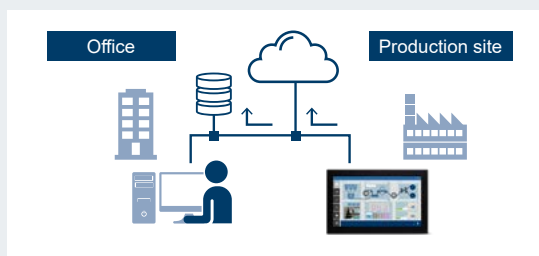

E-mail sending function

Notification by e-mail when an equipment abnormality occurs

An error signal from the equipment triggers the **WH** series to automatically send an e-mail to the concerned personnel notifying the error. Operators can access the display screen of equipment from the office and smartphone using the web server function. The error details can be checked before going to the production site.

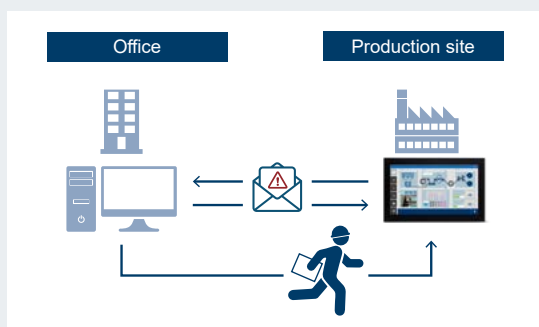

Setting multiple IP addresses

Reduce the burden of managing IP addresses

The higher-level networks can be separated from the lower-level networks in the advanced models using the Ethernet multiple port function. Local IP addresses can be assigned to the lower-level equipment, reducing the company's burden of IP address management.

*Only advanced models. Up to three IP addresses, one for each port can be set. (Note that the **AWHA1C050** is limited to two ports)

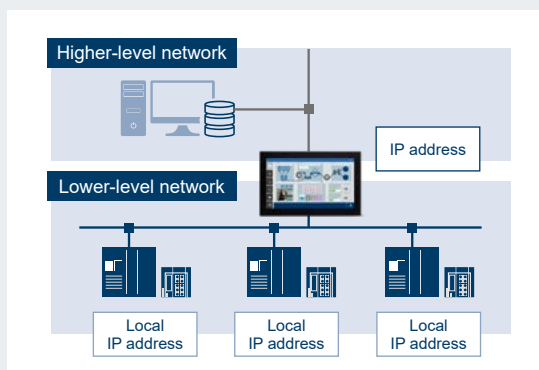

Assisting digital transformation of manufacturing production site with web technology

HIM software (freeware) xAscender Studio



The screens of the **WH** series can be created with simple and intuitive operations. Since web server screens can be created with the same operations, web pages can be easily created without specialized knowledge of computer languages such as HTML.

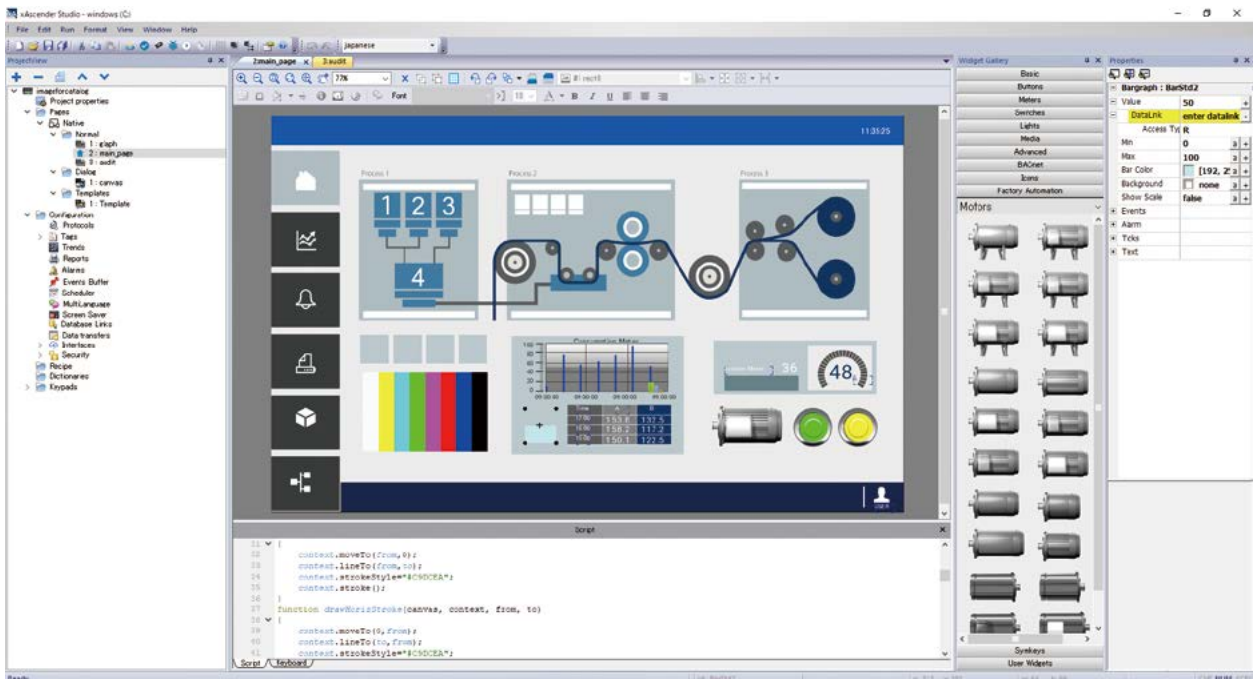

Abundant widgets & tools to improve operability and usability NEW

Using the dashboard function, you can select from seven layout patterns for uniform page designs which improve operability and usability. By using the tab widgets and toolbar widgets, you can quickly change between screens and displayed information with intuitive operations.

You can create a screen by placing parts by drag and drop from the widget gallery. There are two style galleries, Modern / Classic.

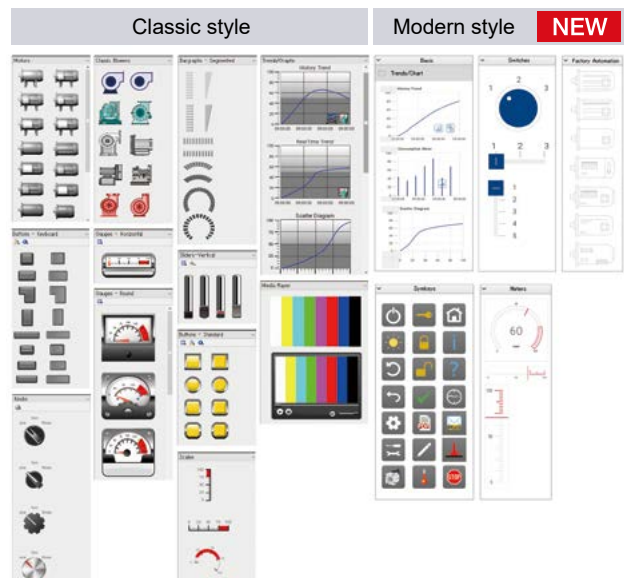
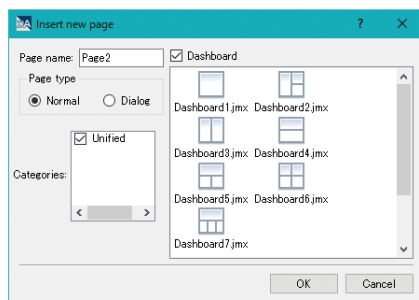

Easily convert web pages into QR codes*

The access URL to the web server screen can be converted into a QR codes and displayed on the screen. By scanning the QR code from the camera of a tablet or smartphone, you can immediately access the web server screen.

*QR code is a registered trademark of DENSO WAVE INCORPORATED.

▶ P.8: APPLICATION “QR code”

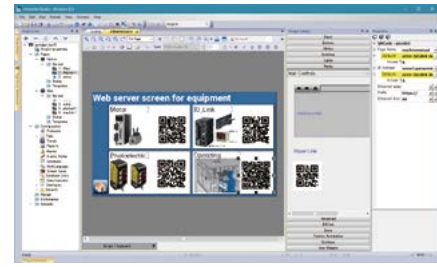

Easily convert web pages into QR codes

Supports connection to database / cloud services

WH supports not only connection to databases such as SQL, but also connection to various cloud services such as AWS using the MQTT interface, and data conversion by OPC UA client service. **NEW**

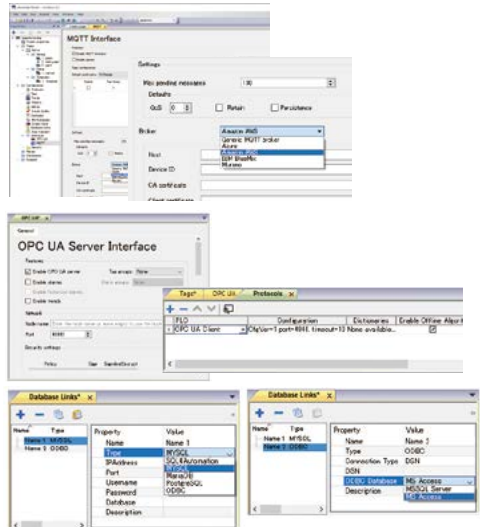

Supports connection to database / cloud services

PDF reports output function

Daily and monthly logs of equipment operation data and can be automatically converted into forms. Output is available in optional formats such as tables (alarms, trends, audit records) for multiple data and trend graphs. This helps to cut the amount of production site hand-written data collection.

▶ P.9: APPLICATION “PDF reports”

FDA "21 CFR Part 11" support functions

Functions which support "21 CFR Part 11" are available, including user management, audit-trail-record traceability and issuance of digital certificate (x.509).

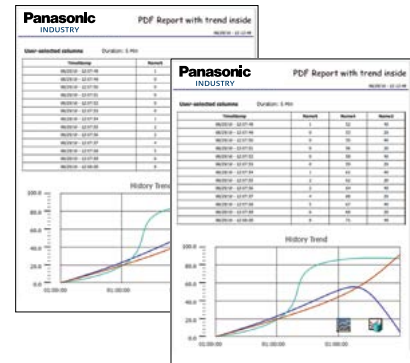

PDF reports output function

Drawing settings Debugging tools

■ Batch editing in Excel

Multiple tags, recipes and alarms can be modified and registered in a batch with Microsoft Excel*, etc.

*Microsoft Excel is a registered trademark or trademark of Microsoft Corporation in the United States and other countries.

■ Simulator function

The created project file can be simulated on PC. Since you can arbitrarily specify the tag value and draw while checking the display, it contributes to reducing man-hours.

■ Remote monitoring software xAscender Client

The monitoring application “xAscender Client” has been prepared for users not using a general-purpose browser when browsing a web server from PC.

*The xAscender Client is set up along with xAscender Studio when the xAscender Suite is installed.

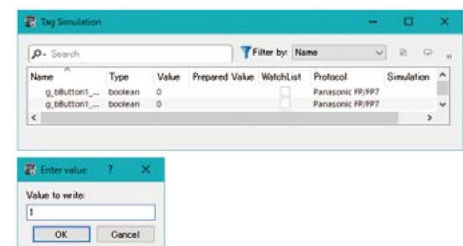

Improved work efficiency using “QR code” and “Tablet”

Quickly bring up the screen you want to see! Contributes to increased maintenance efficiency

Previous issues

Since the display must be operated simultaneously in large equipment, two persons must perform the work.

With WH series

1. Read the QR code on the display with a tablet and go with the screen to check at the work location.
2. When inspecting multiple equipment, the screen for each equipment can be displayed on a tablet, and one person can handle the work.



Quickly check the recovery procedure! Speedy troubleshooting

Previous issues

When a problem occurs, finding the documents, drawings and other necessary items requires time, delaying recovery.

With WH series

1. Quickly access the required page by reading the QR code on the display with tablet.
2. Operate the display while viewing the tablet for quick recovery.
(The URLs of various manuals and drawings, etc., can be switched and displayed according to the problem using QR codes. The operation manual can be viewed on the tablet while performing the recovery operations, reducing the time spent searching for the drawings.)

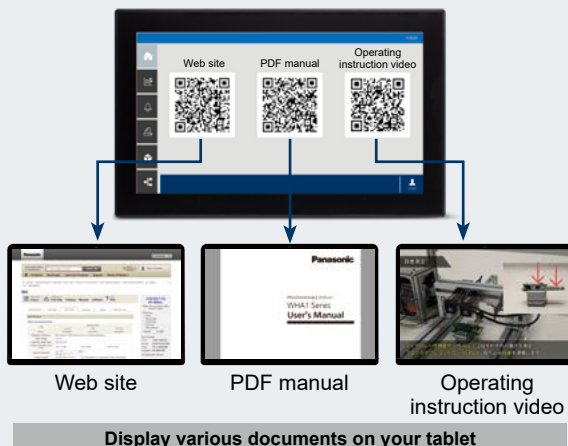

APPLICATION

Reduce manual labor and change to a paperless environment! Automatic inspection data storage and ledger creation

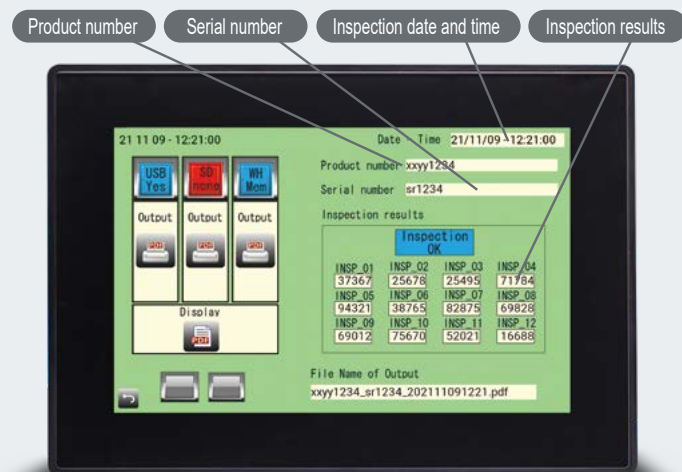

Two types of ledger output

Outputs screenshot of the inspection results

Screen captures of the inspection results screen can be directly converted into PDF files.

Output PDF with an arbitrary layout

If the layout to be displayed is set in advance, PDF files can be output according to the layout. The file name can be set to a combination of “date, time and product number, etc.”.

Supports storage on a network or recording media

The emitted PDF files can be saved not only in the **WH** main unit, but also in the USB memory or SD card via the USB port or SD card slot of the display. Transfer to an FTP server is also possible.



Automatic saving of screen and operation history saving when a problem occurs in the equipment

Input/output information Camera image Error occurrence date and time Various equipment data

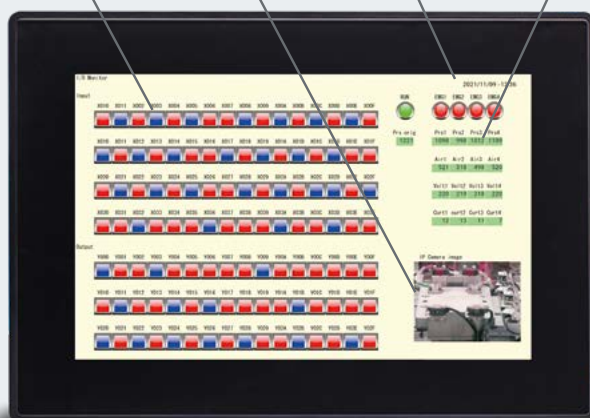

Two types of output timing

Automatic screen output when an error occurs

Prepare the parameters necessary for checking the status of problems on the **WH** screen. When an error occurs, it triggers the automatic capture of the display screen at that moment. The parameters when the failure occurred can be checked in the PDF.

Screen output at an arbitrary timing

A “Report output button” can be created on the screen, allowing the operator to save the screen captured at an arbitrary time as a PDF. This can be used to retain a record of the screen.

The image displayed at the time of capture can be saved by displaying the image on the screen by connecting the display unit to an IP camera, etc.

Advanced model WHA1

16,770,000 colors

Max. 21.5 inch

SD memory card

Capacitive type

Front pure glass

Web server

Equipped with 3 Ethernet ports* and a capacitive type, the large, high end model enables gesture control.

*AWHA1C050 is equipped with two Ethernet ports.



	AWHA1C215	AWHA1C156	AWHA1C101	AWHA1C070	AWHA1C050
Screen size	21.5 inch wide	15.6 inch wide	10.1 inch wide	7 inch wide	5 inch wide
Resolution	Full HD	HD	WXGA	WVGA	WVGA
	1920 × 1080	1366 × 768	1280 × 800	800 × 480	800 × 480
Memory (RAM)	2 GB	2 GB	1 GB	1 GB	512 MB

Equipped with 3 Ethernet ports*

*AWHA1C050 has only two Ethernet ports.

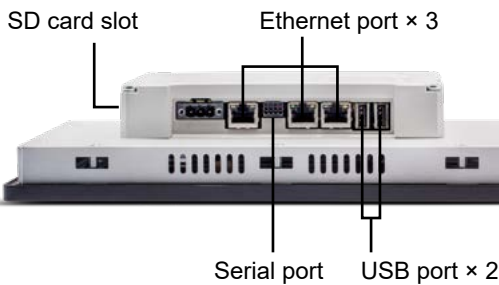

Web server functions*

All models are equipped with web server functions. Pages can be created according to the device terminal on which they will be displayed. The functions can be used for settings, such as preventing switch operations from a remote location or allowing viewing only by administrators.

IP camera

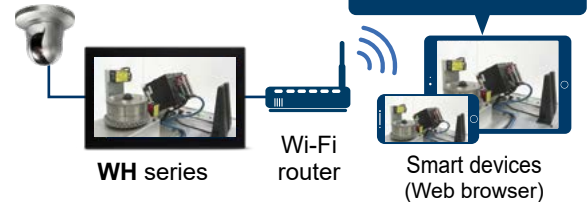

*Standard models are also supported.

Operations can be performed while wearing gloves

The projected capacitive type touchscreen allows comfortable operations with gloves such as rubber gloves or without gloves.



*Performing operations with all types of gloves is not guaranteed. Check the operations in advance.

Support for control gestures

Supports smooth sliding display of areas outside the screen size and ease of viewing in PDF viewers with scrolling (panning) and pinching operations*.



*Pinch operation is supported only by the advanced models, and programming with JavaScript is required. JavaScript is a registered trademark of Oracle Corporation and its subsidiaries and affiliates in the United States and other countries.

Standard model WHS1

65,536 colors

Resistive film type

Web server

Standard model with mid-sized, wide resistive film type for users with focused needs.



	AWHS1R101	AWHS1R070	AWHS1R043
Screen size	10.1 inch wide	7 inch wide	4.3 inch wide
Resolution	WSVGA	WVGA	WQVGA
	1024 × 600	800 × 480	480 × 272
Memory (RAM)	512 MB	512 MB	512 MB

Simple interface

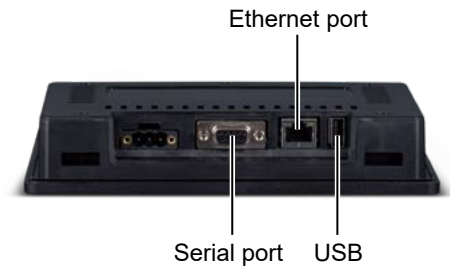

Supported protocols

Same for both advanced and standard models

*Intel is a registered trademark or trademark of Intel Corporation in the United States and other countries.
*Motorola is a registered trademark or trademark of Motorola Trademark Holdings, LLC.
*EtherNet/IP is a trademark of ODVA.

Company name	Protocol	PLC model	Ethernet	Serial (Note 1)
Our company	Panasonic FP, FP7	FP, FP7, GM1	○	○
ABB	ABB SattCon COMLI	Sattcon PLC	○	○
	ABB Mint Controller HCP	ABB Mint Controller		○
Beckhoff	Beckhoff ADS	BC/BX, PC/CX	○	
3S	CODESYS V2 ETH	Intel, Motorola	○	
	CODESYS V2 SER	Intel, Motorola		○
	CODESYS V3 ETH	CODESYS 3	○	
Delta	Delta Modbus RTU	DELTA DVP-PLC		○
ESTA	DMX512 Digital Multiplex	—		○
Eaton	Eaton Suconet-K	PS4, PS341, PS306-316, PS416		○
Fatek	Fatek FACON ETH	FB Series	○	
	Fatek FACON SER	FB Series		○
GE	GE Intelligent Platforms SNP	90 series, VersaMax series, etc.		○
	GE Intelligent Platforms SRTP	90 series, VersaMax series, etc.	○	
	GE SRTP	90 series, VersaMax series, etc.	○	
Hitachi Industrial Equipment Systems	Hitachi ETH	EH150 CPU316/CPU516/CPU548, EHV CPU16.32.64/CPU128, EH-W 10.23, MicroEH 20.40.64	○	
	Hitachi SER	EH150 CPU104/208/316/516/548, EHV CPU16.32.64/CPU128, EH-W 10.23, MicroEH 10.14.23.28/20.40.64		○
IDEC	IDEC Maintenance	FC6A-MicroSmart/MicroSmart Plus, FC5A-MicroSmart Pentra, FC4A-MicroSmart, FT1A-SmartAxis	○	○
Jetter	Jetter Ext ETH	JetControl 3xx pcom7	○	
KEYENCE	Keyence KV	KV10/16/24/40/80/300/700/1000/3000/5000/5500/7300/7500/8000	○	○
KOYO ELECTRONICS INDUSTRIES	Koyo DL	DL105/240/250/260/340/440/450		○
	Koyo DL ETH	ECOM, EBC	○	
Mitsubishi Electric	Mitsubishi FX ETH	FX1N, FX2N, FX3G, FX3U	○	
	Mitsubishi FX SER	FX, FX0/FX0S, FX0N, FX1N, FX1S, FX2N, FX3G, FX3U		○
	Mitsubishi iQ/Q/L ETH	iQ-FX5U, iQ-R, Q00J/Q00/Q01, Q02/Q02H/Q06H/Q12H/Q25H, QnU, Q170M-PLC CPU, Q170M-Motion CPU, L02CPU, L26CPU-BT	○	
	Mitsubishi iQ/Q/L SER	Q00J/Q00/Q01, Q02/Q02H/Q06H/Q12H/Q25H		○
Nidec/Control Techniques	Control Techniques Modbus TCP	—	○	
Omron	Omron FINS ETH	CJx/CS1x/CP1x	○	
	Omron FINS SER	CJx/CS1x/CP1x		○
Rockwell Automation (Allen-Bradley)	A-B DF1	PLC3, PLC5/10/12/15/25/40/40L/60/60L, SLC500 Fixed I/O, Modular I/O, Micrologix 1000/1500, Ultra 5000		○
	A-B DH-485	SLC500 Fixed I/O, Modular I/O, Micrologix 1000/1500		○
	A-B ENET	PLC5 via NET-ENI, PLC5/10-25, Micrologix 1100/1400, SLC500/Micrologix 1000/1200/1500 via NET-ENI	○	
SAIA	SAIA S-BUS	PCD1/2/3		○
	SAIA S-BUS ETH	PCD3	○	
Siemens	Simatic S7 ETH	S7-313/314/315/317/318/319/412/413/414/416/417, S7-1200 CPU 1211/1212/1214/1215/15xx, LOGO! 0BAx/S7-200 SMART	○	
	Simatic S7 MPI	S7-313/314/315/317/318/319/412/413/414/416/417		○
	Simatic S7 PPI	S7-212/214/215/216/221/222/224/226/226MX		○
	Siemens S7 Optimized	S7-1200/1500	○	
ODVA	Ethernet/IP CIP	Logix 5000, Micro800, Omron NJ/CJ Series only	○	
Modbus (Manufacturer: Schneider)	Modbus RTU, Modbus RTU Server	Modicon Modbus (1-based), Generic Modbus (0-based)		○
		Enron Modbus (1-based/0-based) with 32bit registers		○
	Modbus TCP, Modbus TCP Server	Modicon Modbus (1-based), Generic Modbus (0-based)	○	
		Enron Modbus (1-based/0-based) with 32bit registers	○	
OPC	OPC UA Client	—	○	
Other protocol	Protocol	Remarks	Ethernet	Serial (Note 1)
BACnet	BACnet	—	○	○

- Notes: 1) The serial conforms to the serial port (RS-232C, RS-422 or RS-485) of the other device.
 2) Some of the supported protocols are given in the list. Refer to the manual for more details.
 3) Using PLCs other than the **FP** series of our company may restrict the types of devices and addresses that can be used. Refer to the manual for more details.
 4) Communication may not be possible when using RS-485, depending on the transmission and reception timing with the other device. Check with actual devices such as samples in advance.
 5) The company names and product names described in this catalog are registered trademarks or trademarks of their respective companies.

ORDER GUIDE

Main unit

Type	Descriptions							Part No.
	Display	Touch switch	Power supply	Communication		USB	SD	
				Ethernet	Serial			
Standard model	4.3 inch wide TFT	Resistive film type	24 V DC	1 port	1 port RS-232C / RS-422 / RS-485 *Software configurable	1 port	—	AWHS1R043
	7.0 inch wide TFT							AWHS1R070
	10.1 inch wide TFT							AWHS1R101
Advanced model	5.0 inch wide TFT	Capacitive type	24 V DC	2 ports	1 port RS-232C / RS-422 / RS-485 *Software configurable	1 port	1 slot	AWHA1C050
	7.0 inch wide TFT							AWHA1C070
	10.1 inch wide TFT							AWHA1C101
	15.6 inch wide TFT							AWHA1C156
	21.5 inch wide TFT							AWHA1C215

Tool software

Product name	Descriptions	Remarks
xAscender Studio	Screen configuration tool for WH series programmable displays	You can download " xAscender Suite " for free from our website. (Membership registration is required.) " xAscender Suite " includes " xAscender Studio " and " xAscender Client ".
xAscender Client	Tool to enable remote viewing of WH series programmable displays	

Note: **GT** series "**Terminal GTWIN**" programmable display software cannot be used with the **WH** series.
In addition, **WH** series cannot be detected with our IP address search tool, "**Configurator WD**".

SPECIFICATIONS

Main unit specifications

Type	Standard model				Advanced model			
	4.3 inch	7 inch	10.1 inch	5 inch	7 inch	10.1 inch	15.6 inch	21.5 inch
Item	Part No. AWHS1R043	AWHS1R070	AWHS1R101	AWHA1C050	AWHA1C070	AWHA1C101	AWHA1C156	AWHA1C215
Regulatory compliance	EMC Directive, RoHS Directive, UL/c-UL Listing certification, Korea Radio Wave Regulations (Radio Wave Act KC)							
Rated Voltage	24 V DC							
Operating voltage range	10 to 32 V DC				10 to 32 V DC (Note 1)			
Current consumption (at 24 V DC)	0.25 A or less	0.3 A or less	0.38 A or less	0.6 A or less	0.7 A or less	1 A or less	1.2 A or less	1.7 A or less
Ambient temperature	0 to +50 °C +32 to +122 °F (Note 2), Storage -20 to +70 °C -4 to +158 °F				-20 to +50 °C -4 to +122 °F (Note 2), Storage -20 to +70 °C -4 to +158 °F			
Ambient humidity	5 to 85% RH (at +25 °C +77 °F, No condensation or icing allowed, Same when storing)							
Vibration resistance	5 to 9 Hz, 3.5 mm 0.138 in single amplitude, 9 to 150 Hz, Acceleration 9.8 m/s ² (1 G)							
Shock resistance	490 m/s ² (50 G), 11 ms, 3 times in the X, Y, Z directions							
Protection	Front panel: IP66 (Initial value) (Note 3), Rear: IP20							
Pollution degree	2							
Net weight	0.4 kg approx.	0.6 kg approx.	1 kg approx.	1 kg approx.	1.3 kg approx.	2.5 kg approx.	4.1 kg approx.	6.1 kg approx.

Notes: 1) The voltage tolerance range for maintaining a 10 ms voltage dips is limited to 20.4 to 32 V DC. * Does not include connection of external devices.

2) In vertical installation conditions

3) The IP66 is guaranteed only if:

- Max deviation from the plane surface to the cut-out: ≤ 0.5 mm 0.020 in
- Thickness of the case where is mounted the equipment: from 1.5 mm to 6 mm 0.059 in to 0.236 in
- Max surface roughness where the gasket is applied: ≤ 120 μm

Also, tightening torque: 0.75 N·m (for advanced type: 1.3 N·m) or screw each fixing screw until the bezel corner gets in contact with the panel.

Function specifications

Type	Standard model				Advanced model			
	4.3 inch	7 inch	10.1 inch	5 inch	7 inch	10.1 inch	15.6 inch	21.5 inch
Item	Part No. AWHS1R043	AWHS1R070	AWHS1R101	AWHA1C050	AWHA1C070	AWHA1C101	AWHA1C156	AWHA1C215
Displayable fonts	Fixed font, True Type font, Fonts installed in Windows® (Note 1) (Note 2)							
Number of registerable screens (pages) (Note 3)	Max. 1,000							
Registerable screen number	Pages: 1,000 Dialog: 50 Template: 50							
Types of widget	Basic (text, numerics), Button, Meter, Switch, Light, Media, Icon, Custom, etc.							
Main functions	Trends, Reports, Alarms, Scheduler, Database, Data transfers, Recipe, Keypads, Web server, etc.							
Through function	If a PC is connected to the LAN port of a WH series and a PLC is connected into the serial port, the PLC program can be debugged without a direct connection between the computer and the PLC. (Note 4)							

Notes: 1) Windows is a registered trademark of Microsoft Corporation in the United States and other countries.

2) A license (permission to use) is required to add the font.

3) Maximum allowable number varies depending on registered contents.

4) The only supported PLC is our **FP** series.

SPECIFICATIONS

Performance specifications

Item	Type	Standard model			Advanced model					
		4.3 inch	7 inch	10.1 inch	5 inch	7 inch	10.1 inch	15.6 inch	21.5 inch	
	Part No.	AWHS1R043	AWHS1R070	AWHS1R101	AWHA1C050	AWHA1C070	AWHA1C101	AWHA1C156	AWHA1C215	
Display	Display unit	4.3 inch wide TFT	7 inch wide TFT	10.1 inch wide TFT	5.0 inch wide TFT	7.0 inch wide TFT	10.1 inch wide TFT	15.6 inch wide TFT	21.5 inch wide TFT	
	Resolution	480 × 272, WQVGA	800 × 480, WVGA	1,024 × 600, WSVGA	800 × 480, WVGA	800 × 480, WVGA	1,280 × 800, WXGA	1,366 × 768, HD	1,920 × 1,080, Full HD	
	Displayable area	96.4 × 55.2 mm 3.795 × 2.173 in	155.5 × 88 mm 6.122 × 3.465 in	224.3 × 126.8 mm 8.831 × 4.992 in	109 × 65.8 mm 4.291 × 2.591 in	152.6 × 91.6 mm 6.008 × 3.606 in	217.9 × 136.6 mm 8.579 × 5.378 in	345.5 × 195 mm 13.602 × 7.677 in	478 × 269.5 mm 18.819 × 10.610 in	
	Colors	65,536 colors			65,536 colors		16,770,000 colors			
	Backlight	White LED								
	Backlight brightness (Initial)	200 cd/m ² (typ.)			300 cd/m ² (typ.)		500 cd/m ² (typ.)		400 cd/m ² (typ.)	300 cd/m ² (typ.)
	Dimming	Yes (Can be adjusted on the menu screen, xAscender Studio settings.) *There are some minor variations in the backlight brightness.								
	Backlight life time	20,000 hours or more (Note 2)			40,000 hours or more (Note 2)					
Touch switch	Touch switch	Analog resistive film type			Capacitive type					
	Touch switch operating	1.5 N or less			————					
	Life time	1 million times or more (Note 3)			————					
Memory space	RAM	512 MB			512 MB	1 GB	1 GB	2 GB	2 GB	
	Flash memory	4 GB			4 GB	4 GB	4 GB	8 GB	8 GB	
	Project memory	240 MB								
	User memory	512 MB								
RTC / Backup	Clock function	Yes								
	Accuracy RTC	±100 ppm or less (at +25 °C +77 °F) (Note 4)								
	Backup range	Clock back up								
	Backup function / period	48h with super capacitor backup (at +25 °C +77 °F) (Note 5)			3 months with lithium batteries (secondary batteries) (at +25 °C +77 °F) (Note 5)					
Other	Buzzer									

- Notes: 1) On the LCD panel, bright spots (points always lit) or black spots (points always unlit) may appear, or the uneven brightness, flickers or crosstalk (appearance of unintended shades in the area no graphic or part is arranged) may occur depending on the operating conditions. Note that these phenomena are resulted from the basic characteristics of LCD panel not defects or failures of the product.
- 2) Time of continuous operation until the brightness of the backlight reaches 50% of the rated value when the surrounding air temperature is +25 °C +77 °F
- 3) The touch position may shift due to aging variation. If the touch position has shifted greatly, please adjust it.
- 4) At +25 °C +77 °F: less than 260 seconds per month. On systems prone to clock error, set the correct time on a regular basis.
- 5) Must be charged for 48 hours. When the battery is fully charged, it ensures a period of 48 hours of data backup.

Interface specifications

Ethernet port communication specifications

Item	Type	Standard model			Advanced model					
		4.3 inch	7 inch	10.1 inch	5 inch	7 inch	10.1 inch	15.6 inch	21.5 inch	
	Part No.	AWHS1R043	AWHS1R070	AWHS1R101	AWHA1C050	AWHA1C070	AWHA1C101	AWHA1C156	AWHA1C215	
Number of communication ports		1 port			2 ports		3 ports			
Interface		100BASE-TX / 10BASE-T								
Baud rate		100 Mbps / 10 Mbps, Auto negotiation (Note 2)								
Connector shape		RJ-45 (Note 3)								
Cable total length		100 m 328.084 ft (500 m 1,640.42 ft when using a repeater) (Note 4)								
Communication cable		UTP cable (Category 5 or higher)								
Number of web client simultaneous connections		Max. 4								
Communication method		Full-duplex / Half-duplex								
Communication protocol		TCP/IP, UDP/IP								
DNS		Name server support								
DHCP		Correspondence of automatic IP address acquisition								
FTP server / client		Server function: Transfer file / Client function: Transfer data and file								
HTTP server / client		Server function: Customer web / Client function: Web browser								
SNTP		Correspondence of time setting function								

- Notes: 1) Ethernet is a registered trademark of FUJIFILM Business Innovation Corp. and Xerox Corp.
- 2) Switching between different speeds is done automatically by auto negotiation function.
- 3) Be careful not to apply excessive static electricity to the metal parts of the connector.
- 4) The maximum length of the cable is 100 m **328.084 ft** in accordance with the standards, but depending on the operating environment, a ferrite core may be installed to reduce noise. May be required. It is also recommended that the hub be installed near the control panel and that it be used at 10 m **32.808 ft** or less.

Interface specifications

Serial port communication specifications (Same for both standard and advanced models)

Item \ Type	RS-232C	RS-422 / RS-485
Communication standard	Conforms to RS-232C (Non insulation type)	Conforms to RS-422 / RS-485 (Non insulation type)
Number of communication ports	1 port *Can be switched with xAscender Studio	
Conditions for communication with external devices	Baud rate	1200, 2400, 4800, 9600, 19200, 38400, 57600, 115200 bit/s (Note 1)
	Data bits	7 bits / 8 bits
	Parity	none / even / odd
	Stop bit	1 bit / 2 bit
Transmission distance (Total length)	Max. 15 m 49.213 ft (for advanced model: Max. 15 m 49.213 ft) (Baud rate: 19,200 bps)	Max. 500 m 1,640.42 ft (Baud rate: 115.2 kbps)
Terminal resistance	—	No termination (Note 2)
Connector	D-Sub 9 pins (Note 3) (Connector supplied with advanced model)	

- Notes: 1) Communication conditions depend on the communications state of PLCs or other slave devices. Please check with the actual devices when some commercial devices with RS-485 interface are connected. The number of connected devices, transmission distance, and transmission speed may be different according to using transmission line.
 2) When connected to the termination, it is recommended that a 120Ω, 1/2W or better termination resistor be connected between the communication lines.
 3) Use standard commercially available 9-pin D-sub male connector.

USB port specifications

Item \ Type	Part No.	Standard model			Advanced model					
		4.3 inch	7 inch	10.1 inch	5 inch	7 inch	10.1 inch	15.6 inch	21.5 inch	
Number of ports		1 port			1 port	2 ports				
USB specifications		USB Host								
Electrical specifications		Complies with USB 2.0								
Connector shape		USB Type A (Note 1)								
Transmission speed		480 Mbps (High speed mode)								
Maximum current		Max. 500 mA								

- Notes: 1) Take care of handling of the connector not to add an excessive static electricity on the metal part of the connector.
 2) The format of the external memory should be in FAT32 or FAT. The max number of files inside external memory depends on the type of formatting. (Supports up to 32 GB capacity.)
 • FAT32: Max. 65,535 files
 • FAT: Max. 512 files

SD memory card specifications

Item \ Type	Part No.	Standard model			Advanced model				
		4.3 inch	7 inch	10.1 inch	5 inch	7 inch	10.1 inch	15.6 inch	21.5 inch
Support media		—			SD memory card, SDHC memory card (Note 1)				
Supported format standard		—			Conforms to SD standard (Note 2) (Please format with a format software for SD memory cards.)				

- Notes: 1) Industrial or business use SD memory cards (SLC type) are recommended. Check the operating temperature range of the SD memory card before use.
 2) The format of the external memory should be in FAT32 or FAT. The max number of files inside external memory depends on the type of formatting. (Supports up to 32 GB capacity.)
 • FAT32: Max. 65,535 files
 • FAT: Max. 512 files

DIMENSIONS (Unit: mm in)

The CAD data can be downloaded from our website.

AWHS1R043 / AWHS1R070 / AWHS1R101 Standard model

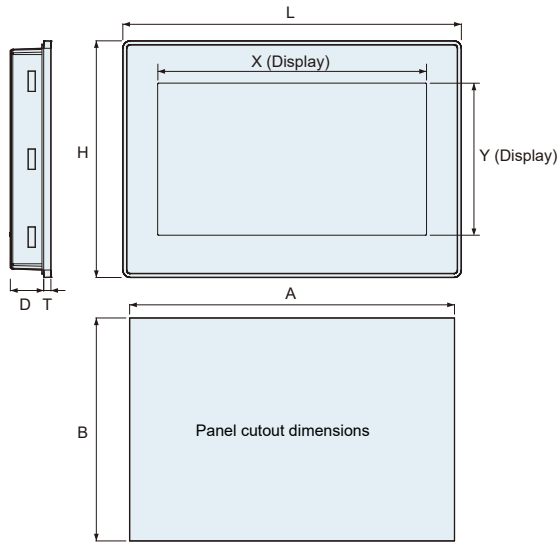

Part No.	A	B	L	H	X	Y	D	T
AWHS1R043	136 5.354	96 3.780	147 5.787	107 4.213	96.4 3.795	55.2 2.173	29 1.142	5 0.197
AWHS1R070	176 6.929	136 5.354	187 7.362	147 5.787	155.5 6.122	88 3.465	29 1.142	5 0.197
AWHS1R101	271 10.669	186 7.323	282 11.102	197 7.756	224.3 8.831	126.8 4.992	28 1.102	6 0.236

(Tolerance (except T): ±1 mm ±0.039 in)
 T tolerance: ±0.5 mm ±0.020 in

AWHA1C050 Advanced model

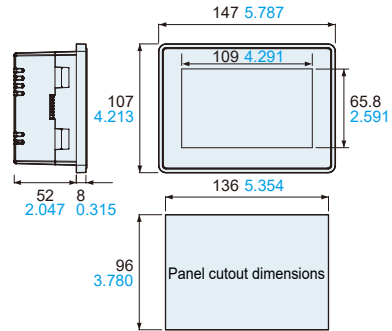

AWHA1C070 / AWHA1C101 / AWHA1C156 / AWHA1C215 Advanced model

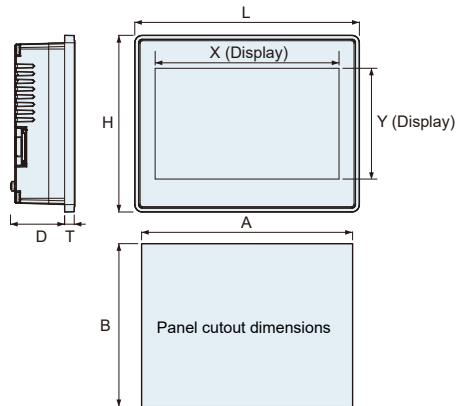

Part No.	A	B	L	H	X	Y	D	T
AWHA1C070	176 6.929	136 5.354	187 7.362	147 5.787	152.6 6.008	91.6 3.606	45 1.772	8 0.315
AWHA1C101	271 10.669	186 7.323	282 11.102	197 7.756	217.9 8.579	136.6 5.378	52 2.047	8 0.315
AWHA1C156	411 16.181	256 10.079	422 16.614	267 10.512	345.5 13.602	195 7.677	56 2.205	8 0.315
AWHA1C215	541 21.299	336 13.228	552 21.732	347 13.661	478 18.819	269.5 10.610	56 2.205	8 0.315

(Tolerance (except T): ±1 mm ±0.039 in)
 T tolerance: ±0.5 mm ±0.020 in

PRECAUTIONS FOR PROPER USE

Information security precautions

When use this product you might receive damage as listed below.

- (1) Information leakage or outflow through this product
- (2) Fraudulent operation of this product by a malicious third party
- (3) Obstructing or stopping this product by a malicious third party

Sufficient measures, including the following measures, should be taken at your own risk to prevent such damages.

■ Data storage

- Do not storage of personal information on this product.

■ Password

- Please be sure to change the password since it is set to the default value at the time of purchase. Do not use the default password.
- Please be responsible for managing your password so that it is not known to any third party and do not forget it. If you forget the internal password, you must return it to factory default condition.
- Please make sure that your password is at least 8 characters long and contains a combination of upper and lower case letters, numbers and symbols so that a third party cannot guess your password.
- Do not use the same password as your user name. Do not use the same password as the one you are using elsewhere.
- Please change your password on a regular basis.

■ Networks

- Use this product on a network where safety is secured by using a firewall.

- When using this product on a system where a PC is connected, make sure that checking and cleaning of infection by computer virus or malicious program is performed periodically.
- It has the ability to use unencrypted communications. (FTP, HTTP, SMTP, PLC communications, etc.). Please make sure that a third party cannot easily connect to the network used by this product.
- Use HTTPS when accessing this product through a web browser. Also, be sure to close all browsers after accessing it.
- Do disable the functions of the services you don't use. (SNMP, NTP, VNC, DHCP, etc.)
- Be sure to log out when you have completed the necessary setup operations.
- SNMP is assumed to be used for testing purposes. It should be disabled during operation. Furthermore, it is recommended that the product be used in an environment that has VPN (Virtual Private Network) or leased line network.

■ Transfer / Disposal / Repair

- If the product is to be disposed of, transferred, repaired, or otherwise transferred to a third party, important information may also be recorded on the product and on the external recording media used. At customer's risk, please handle it with care, such as erasing it.

■ Installation

- On the back of the unit, there are interfaces that affect its operation, such as power supply, external storage media, and communication connectors. Please make sure to install the unit in a manner that does not allow unauthorized parties to touch it.

■ Exemption

- The Company shall not be responsible for any information security problems or damages that may occur to you in the event that you fail to comply with the above precautions in using this product.

Disclaimer

The applications described in the catalog are all intended for examples only. The purchase of our products described in the catalog shall not be regarded as granting of a license to use our products in the described applications. We do NOT warrant that we have obtained some intellectual properties, such as patent rights, with respect to such applications, or that the described applications may not infringe any intellectual property rights, such as patent rights, of a third party.

Panasonic
INDUSTRY

Panasonic Industry Co., Ltd.

Industrial Device Business Division
7-1-1, Morofuku, Daito-shi, Osaka 574-0044, Japan
industrial.panasonic.com/ac/e/