

# NCP4687

## 500 mA, High PSRR, LDO Linear Voltage Regulator

The NCP4687 is a CMOS 500 mA LDO linear voltage regulator with high output voltage accuracy which features a high ripple rejection, low supply current with low dropout and chip enable with built-in low  $R_{DS(on)}$  NMOS transistor for fast output capacitor discharging as option. The device is composed of the voltage reference unit, error amplifier, resistor divider for output voltage sensing or precise output voltage setting. The current limit and thermal shutdown makes the device very suitable for industrial applications and portable communication equipments.

### Features

- Operating Input Voltage Range: 2.5 V to 5.25 V
- Output Voltage Range: 0.7 to 3.6 V (available in 0.1 V steps)
- $\pm 0.8\%$  Output Voltage Accuracy @  $V_{out} > 1.8$  V
- Output noise :  $40 \mu V_{rms}$
- Line Regulation:  $0.02\%/V$
- Current Limit Circuit
- High PSRR: 75 dB at 1 kHz, 70 dB at 10 kHz
- Thermal Shutdown
- Available in SOT-23-5, SOT-89-5 and uDFN 1.2 x 1.2 mm Packages
- These Devices are Pb-Free and are RoHS Compliant

### Typical Applications

- Home Appliances, Industrial Equipment
- DVB-T and DVB-S Receivers
- Car Audio Equipment, Navigation Systems
- Notebook Adaptors, LCD TVs, Cordless Phones and Private LAN Systems

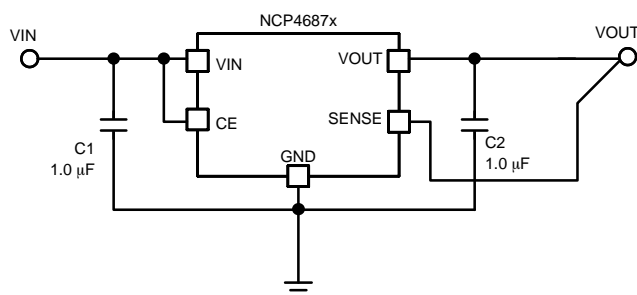

Figure 1. Typical Application Schematic



ON Semiconductor™

<http://onsemi.com>

### MARKING DIAGRAMS



SOT89-5  
CASE 528AB

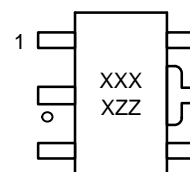

XDFN6  
CASE 711AH



SOT-23-5  
CASE 1212

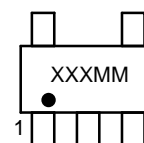

XX, XXX = Specific Device Code  
ZZ = Lot Code  
MM = Date Code

### ORDERING INFORMATION

See detailed ordering and shipping information in the package dimensions section on page 15 of this data sheet.

# NCP4687

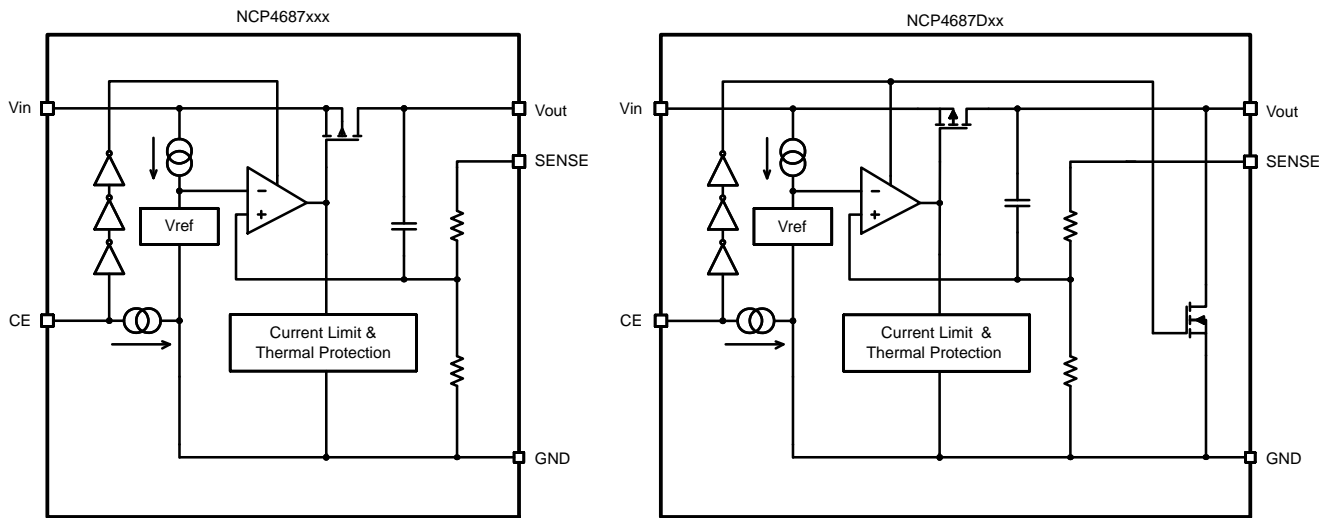

Figure 2. Simplified Schematic Block Diagram

## PIN FUNCTION DESCRIPTION

| Pin No.<br>SOT-23-5 | Pin No.<br>SOT-89-5 | Pin No.<br>DFN1212 | Pin Name | Description                                    |
|---------------------|---------------------|--------------------|----------|--|
| 1                   | 4                   | 6                  | VIN      | Input pin                                      |
| 2                   | 2                   | 3                  | GND      | Ground pin                                     |
| 3                   | 3                   | 4                  | CE       | Chip enable pin ("H" active)                   |
| 4                   | 1                   | 2                  | SENSE    | Output Voltage Sensing                         |
| 5                   | 5                   | 1                  | VOUT     | Output pin                                     |
|                     |                     | 5                  | NC       | Non Connected                                  |
|                     |                     | *EP                | EP       | Exposed Pad (leave floating or connect to GND) |

# NCP4687

## ABSOLUTE MAXIMUM RATINGS

| Rating                                    | Symbol      | Value                  | Unit |
|---|-------------|------------------------|------|
| Input Voltage                             | $V_{IN}$    | 0 – 6                  | V    |
| Output Voltage                            | $V_{OUT}$   | -0.3 to $V_{IN} - 0.3$ | V    |
| Chip Enable Input                         | $V_{CE}$    | -0.3 – 6               | V    |
| Power Dissipation SOT-23-5                | $P_D$       | 420                    | mW   |
| Power Dissipation uDFN 1.2 x 1.2 mm       |             | 600                    |      |
| Power Dissipation SOT-89-5                |             | 900                    |      |
| Junction Temperature                      | $T_J$       | -40 to 150             | °C   |
| Storage Temperature                       | $T_{STG}$   | -55 to 125             | °C   |
| ESD Capability, Human Body Model (Note 1) | $ESD_{HBM}$ | 2000                   | V    |
| ESD Capability, Machine Model (Note 1)    | $ESD_{MM}$  | 200                    | V    |

Stresses exceeding those listed in the Maximum Ratings table may damage the device. If any of these limits are exceeded, device functionality should not be assumed, damage may occur and reliability may be affected.

- This device series incorporates ESD protection and is tested by the following methods:  
 ESD Human Body Model tested per AEC-Q100-002 (EIA/JESD22-A114)  
 ESD Machine Model tested per AEC-Q100-003 (EIA/JESD22-A115)  
 Latchup Current Maximum Rating tested per JEDEC standard: JESD78

## THERMAL CHARACTERISTICS

| Rating   | Symbol          | Value | Unit |
|--|-----------------|-------|------|
| Thermal Characteristics, SOT-23-5<br>Thermal Resistance, Junction-to-Air     | $R_{\theta JA}$ | 238   | °C/W |
| Thermal Characteristics, uDFN 1.2x1.2<br>Thermal Resistance, Junction-to-Air | $R_{\theta JA}$ | 167   | °C/W |
| Thermal Characteristics, SOT-89-5<br>Thermal Resistance, Junction-to-Air     | $R_{\theta JA}$ | 111   | °C/W |

# NCP4687

**ELECTRICAL CHARACTERISTICS**  $-40^{\circ}\text{C} \leq T_A \leq 85^{\circ}\text{C}$ ;  $C_{IN} = C_{OUT} = 1.0 \mu\text{F}$ , unless otherwise noted. Typical values are at  $T_A = +25^{\circ}\text{C}$ .

| Parameter                        | Test Conditions   | Symbol                     | Min  | Typ       | Max            | Unit                       |               |
|----------------------------------|---|----------------------------|--|-----------|----------------|----------------------------|---------------|
| Operating Input Voltage          | $V_{OUT} \leq 1.5 \text{ V}$  | $V_{IN}$                   | 2.5  |           | 5.25           | V                          |               |
|                                  | $V_{OUT} > 1.5 \text{ V}$   |                            | $V_{OUT} + 1$                                | 5.25      |                |                            |               |
| Output Voltage                   | $T_a = 25^{\circ}\text{C}$ , $V_{OUT} > 1.8 \text{ V}$  | $V_{OUT}$                  | x0.992                                       |           | x1.008         | V                          |               |
|                                  | $-40^{\circ}\text{C} < T_a < 85^{\circ}\text{C}$ , $V_{OUT} > 1.8 \text{ V}$  |                            | x0.985                                       |           | x1.015         | V                          |               |
|                                  | $T_a = 25^{\circ}\text{C}$ , $V_{OUT} \leq 1.8 \text{ V}$   |                            | -18  |           | +18            | mV                         |               |
|                                  | $-40^{\circ}\text{C} < T_a < 85^{\circ}\text{C}$ , $V_{OUT} \leq 1.8 \text{ V}$   |                            | -55  |           | +55            | mV                         |               |
| Output Voltage Temp. Coefficient | $-40^{\circ}\text{C} < T_a < 85^{\circ}\text{C}$ , $V_{OUT} > 1.8 \text{ V}$  |                            |  | $\pm 30$  |                | ppm/ $^{\circ}\text{C}$    |               |
|                                  | $-40^{\circ}\text{C} < T_a < 85^{\circ}\text{C}$ , $V_{OUT} \leq 1.8 \text{ V}$   |                            |  | $\pm 100$ |                |                            |               |
| Load Regulation                  | $1 \text{ mA} < I_{OUT} \leq 500 \text{ mA}$  | $\text{Load}_{\text{Reg}}$ |  | 1         | 20             | mV                         |               |
| Line Regulation                  | Set $V_{OUT} + 0.5 \text{ V} < V_{IN} < 5.25 \text{ V}$   | $\text{Line}_{\text{Reg}}$ |  | 0.02      | 0.1            | %/V                        |               |
| Dropout Voltage                  | $I_{OUT} = 500 \text{ mA}$  | $V_{DO}$                   | $0.7 \text{ V} \leq V_{OUT} < 0.8 \text{ V}$ |           | 0.58           | 0.88                       | V             |
|                                  |   |                            | $0.8 \text{ V} \leq V_{OUT} < 0.9 \text{ V}$ |           | 0.52           | 0.80                       |               |
|                                  |   |                            | $0.9 \text{ V} \leq V_{OUT} < 1.0 \text{ V}$ |           | 0.45           | 0.70                       |               |
|                                  |   |                            | $1.0 \text{ V} \leq V_{OUT} < 1.2 \text{ V}$ |           | 0.42           | 0.64                       |               |
|                                  |   |                            | $1.2 \text{ V} \leq V_{OUT} < 1.4 \text{ V}$ |           | 0.35           | 0.53                       |               |
|                                  |   |                            | $1.4 \text{ V} \leq V_{OUT} < 1.8 \text{ V}$ |           | 0.31           | 0.48                       |               |
|                                  |   |                            | $1.8 \text{ V} \leq V_{OUT} < 2.1 \text{ V}$ |           | 0.27           | 0.41                       |               |
|                                  |   |                            | $2.1 \text{ V} \leq V_{OUT} < 2.5 \text{ V}$ |           | 0.25           | 0.38                       |               |
|                                  |   |                            | $2.5 \text{ V} \leq V_{OUT} < 3.0 \text{ V}$ |           | 0.23           | 0.34                       |               |
|                                  |   |                            | $3.0 \text{ V} \leq V_{OUT} < 3.6 \text{ V}$ |           | 0.22           | 0.32                       |               |
| Output Current                   |   | $I_{OUT}$                  | 500  |           |                | mA                         |               |
| Short Current Limit              | $V_{OUT} = 0 \text{ V}$   | $I_{SC}$                   |  | 50        |                | mA                         |               |
| Quiescent Current                | $I_{OUT} = 0 \text{ mA}$  | $I_q$                      | $V_{OUT} > 1.5 \text{ V}$                    |           | 80             | 115                        | $\mu\text{A}$ |
|                                  |   |                            | $V_{OUT} \leq 1.5 \text{ V}$                 |           | 75             |                            |               |
| Standby Current                  | $V_{IN} = V_{IN \text{ max}}$ , $V_{CE} = 0 \text{ V}$  | $I_{STB}$                  |  | 0.1       | 1.0            | $\mu\text{A}$              |               |
| CE Pin Pull-Down Current         |   | $I_{PD}$                   |  | 0.3       | 0.6            | $\mu\text{A}$              |               |
| CE Pin Threshold Voltage         | CE Input Voltage "H"  | $V_{CEH}$                  | 1.0  |           | $V_{IN}$       | V                          |               |
|                                  | CE Input Voltage "L"  | $V_{CEL}$                  |  |           | 0.4            |                            |               |
| Power Supply Rejection Ratio     | $V_{OUT} \leq 2.0 \text{ V}$ @ $V_{IN} = 3.0 \text{ V}$ ,<br>$V_{OUT} > 2.0 \text{ V}$ @ $V_{IN} =$<br>= Set $V_{OUT} + 1.0 \text{ V}$ ,<br>$\Delta V_{IN\_PK-PK} = 0.2 \text{ V}$ ,<br>$I_{OUT} = 30 \text{ mA}$ | PSRR                       | $f = 1 \text{ kHz}$                          |           | 75             | dB                         |               |
|                                  |   |                            | $f = 10 \text{ kHz}$                         |           | 70             |                            |               |
| Output Noise Voltage             | $I_{OUT} = 30 \text{ mA}$ , $f = 10 \text{ Hz}$ to $100 \text{ kHz}$ , $V_{OUT} > 1.8 \text{ V}$  | $V_{NOISE}$                |  |           | 20 x $V_{OUT}$ | $\mu\text{V}_{\text{rms}}$ |               |
|                                  | $I_{OUT} = 30 \text{ mA}$ , $f = 10 \text{ Hz}$ to $100 \text{ kHz}$ , $V_{OUT} \leq 1.8 \text{ V}$   |                            |  |           | 40 x $V_{OUT}$ |                            |               |
| Thermal Shutdown / Hysteresis    |   |                            |  | 165/65    |                | $^{\circ}\text{C}$         |               |
| Auto-discharge N-MOS Resistance  | $V_{IN} = 4.0 \text{ V}$ , $V_{CE} = 0.0 \text{ V}$ (Note 2)  | $R_{DS(on)}$               |  | 60        |                | $\Omega$                   |               |

Product parametric performance is indicated in the Electrical Characteristics for the listed test conditions, unless otherwise noted. Product performance may not be indicated by the Electrical Characteristics if operated under different conditions.

2.

TYPICAL CHARACTERISTICS

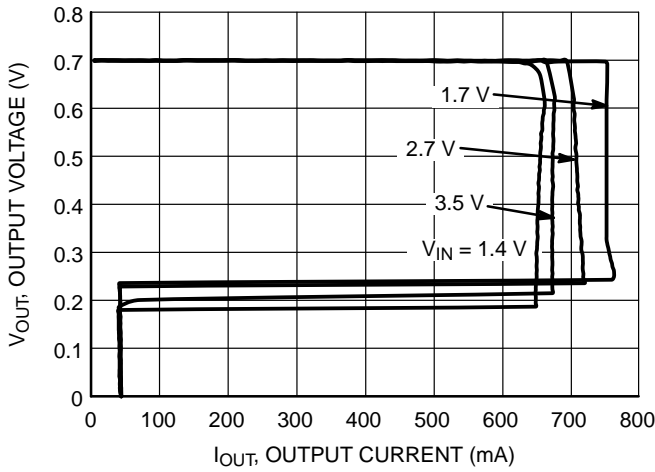

Figure 3. Output Voltage vs. Output Current 0.7 V Version

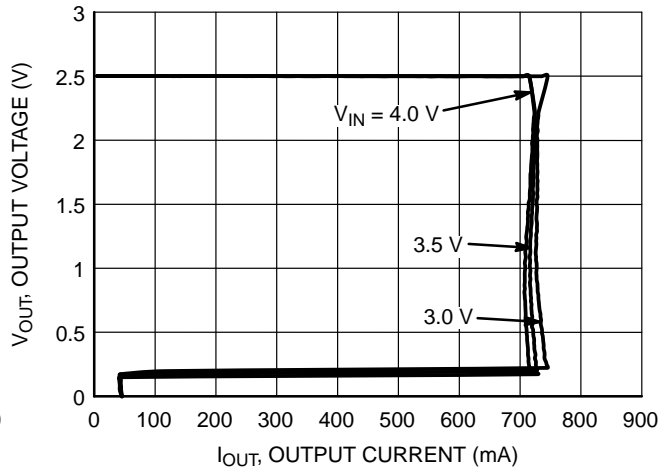

Figure 4. Output Voltage vs. Output Current 2.5 V Version

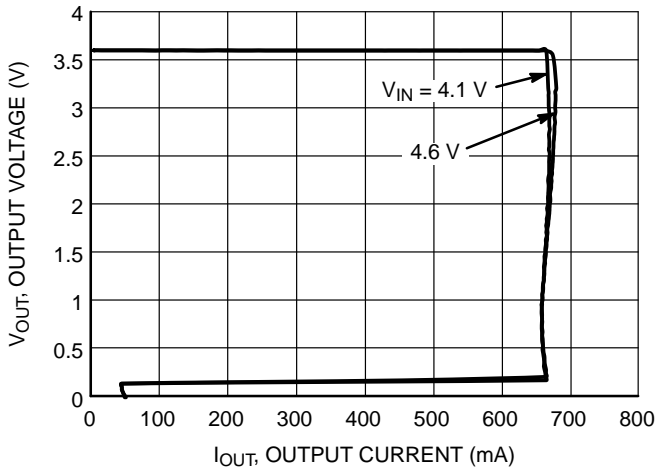

Figure 5. Output Voltage vs. Output Current 3.6 V Version

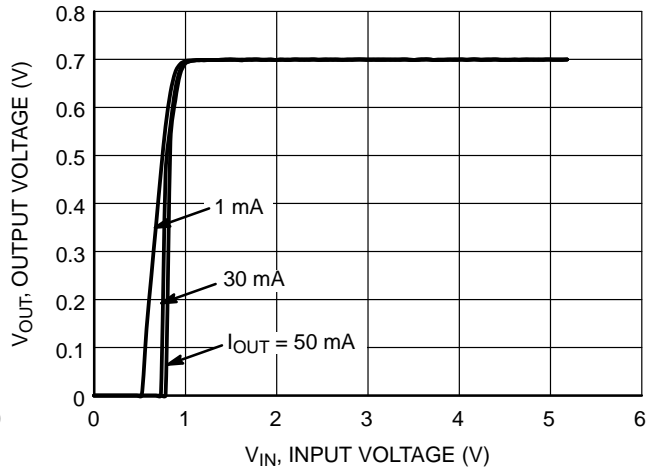

Figure 6. Output Voltage vs. Input Voltage 0.7 V Version

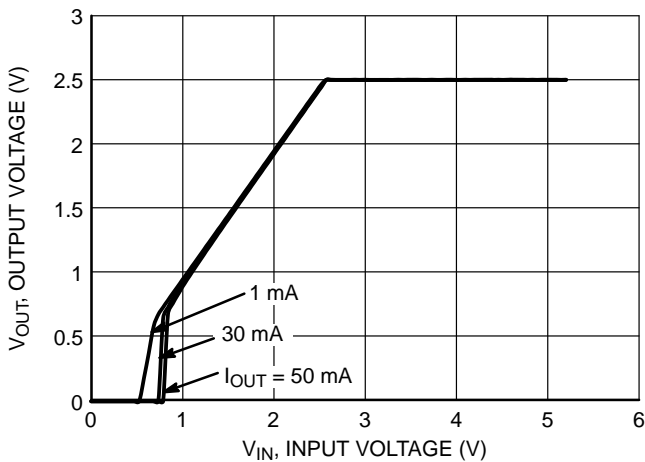

Figure 7. Output Voltage vs. Input Voltage 2.5 V Version

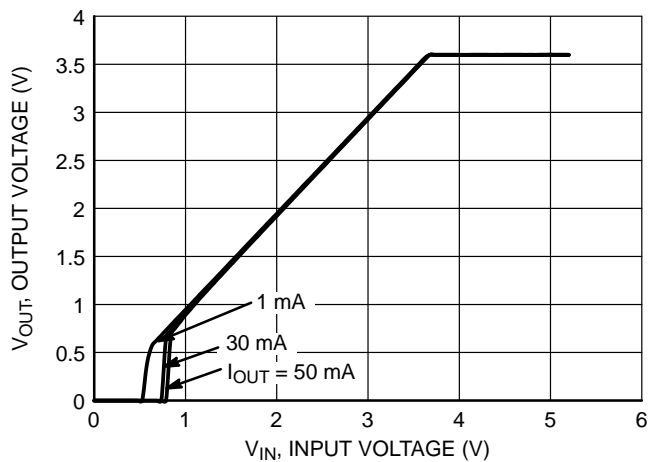

Figure 8. Output Voltage vs. Input Voltage 3.6 V Version

TYPICAL CHARACTERISTICS

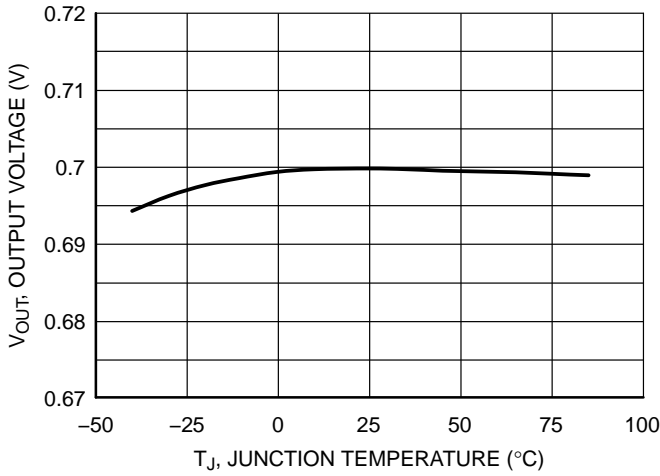

Figure 9. Output Voltage vs. Temperature, 0.7 V Version

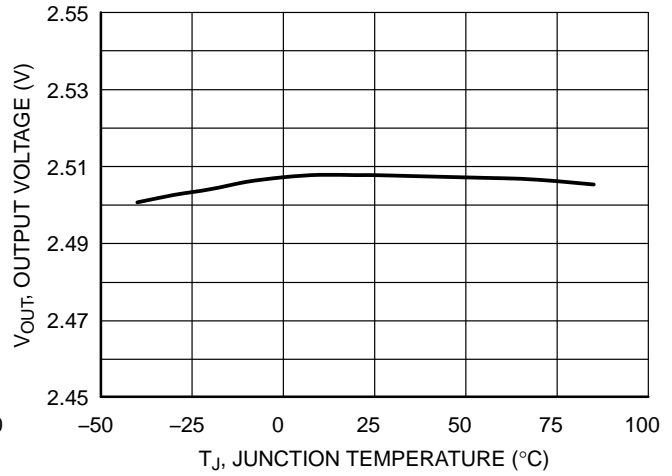

Figure 10. Output Voltage vs. Temperature, 2.5 V Version

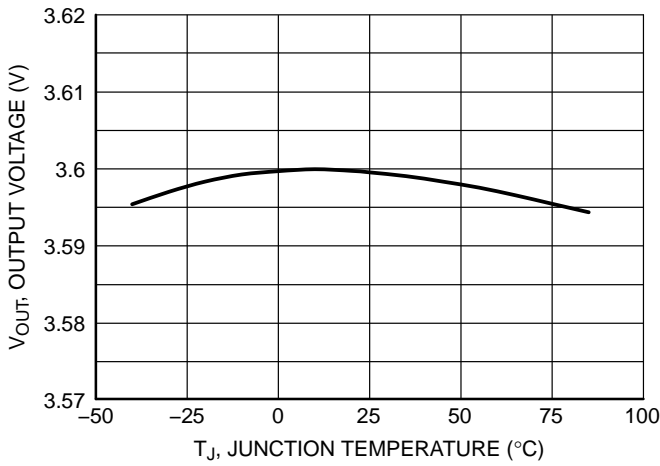

Figure 11. Output Voltage vs. Temperature, 3.6 V Version

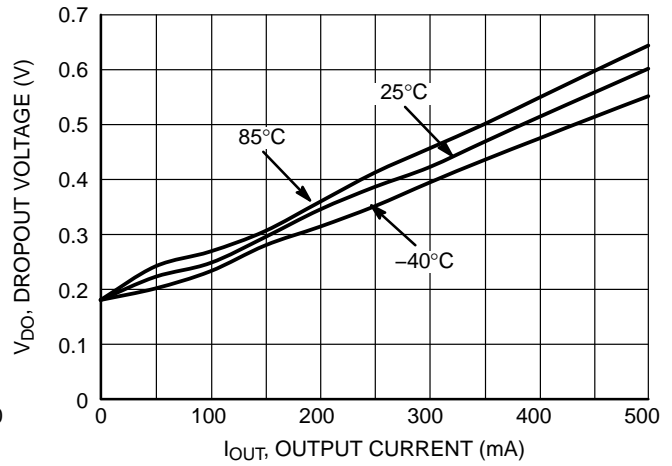

Figure 12. Dropout Voltage vs. Output Current, 0.7 V Version

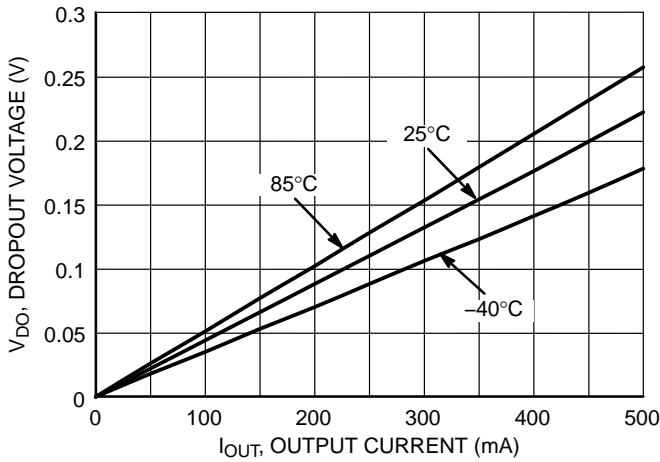

Figure 13. Dropout Voltage vs. Output Current, 2.5 V Version

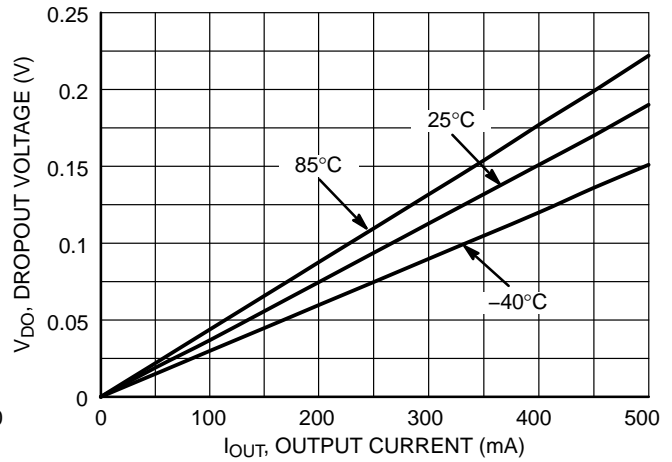

Figure 14. Dropout Voltage vs. Output Current, 3.6 V Version

TYPICAL CHARACTERISTICS

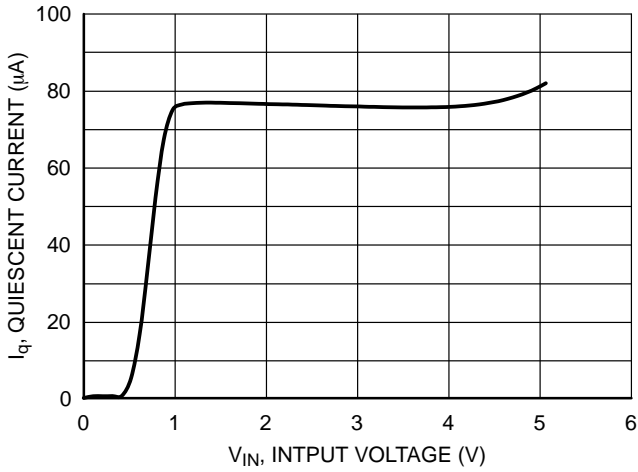

Figure 15. Quiescent Current vs. Input Voltage, 0.7 V Version

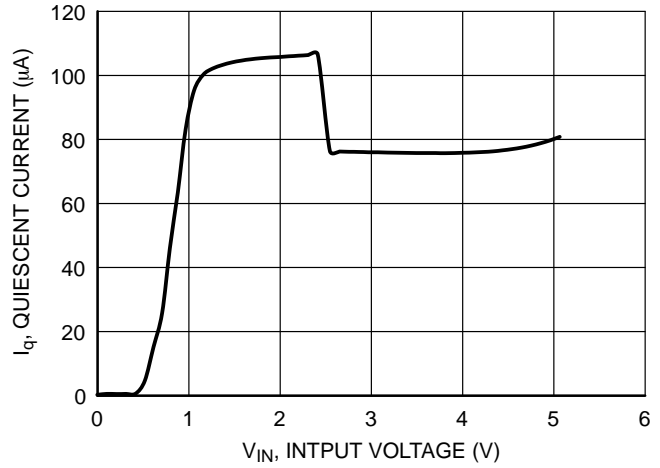

Figure 16. Quiescent Current vs. Input Voltage, 2.5 V Version

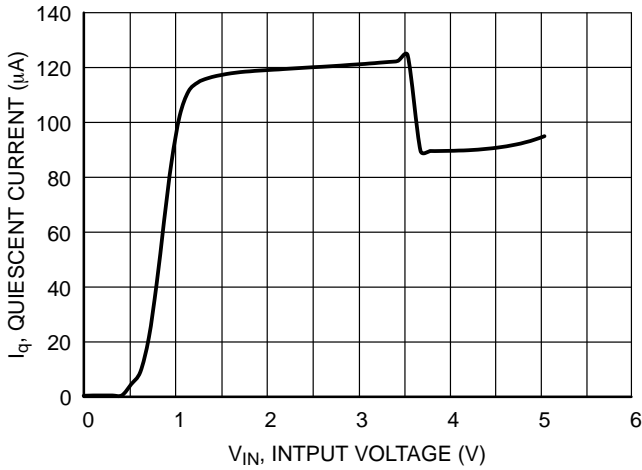

Figure 17. Quiescent Current vs. Input Voltage, 3.6 V Version

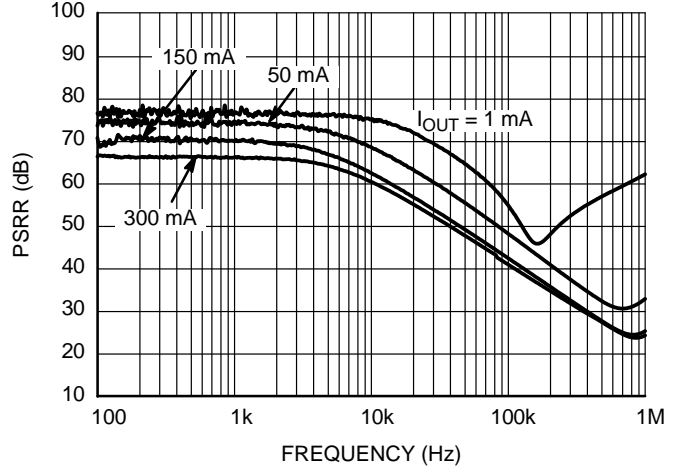

Figure 18. PSRR vs. Frequency, 0.7 V Version

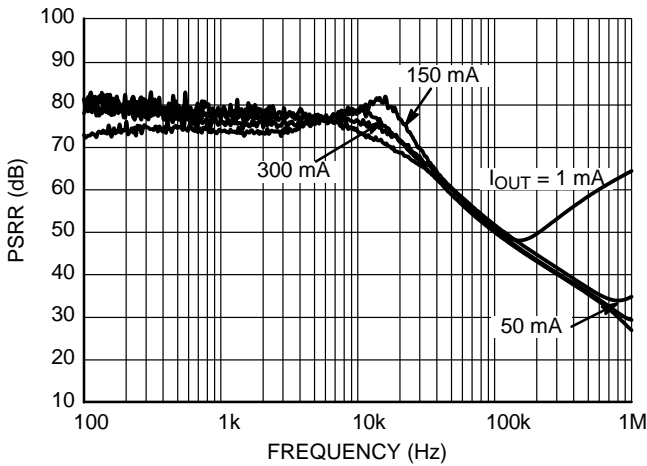

Figure 19. PSRR vs. Frequency, 2.5 V Version

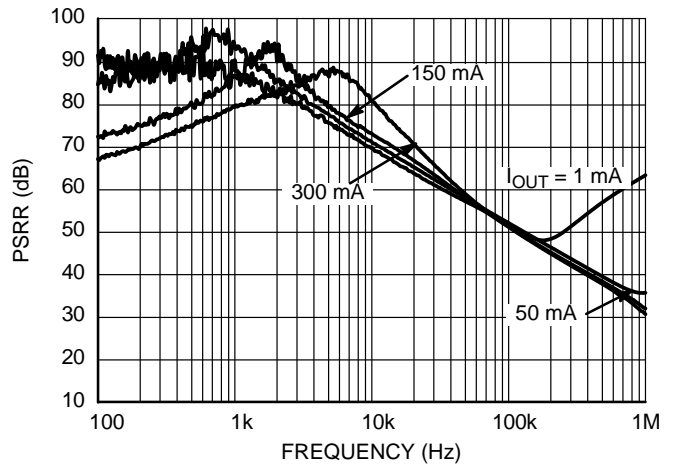

Figure 20. PSRR vs. Frequency, 3.6 V Version

TYPICAL CHARACTERISTICS

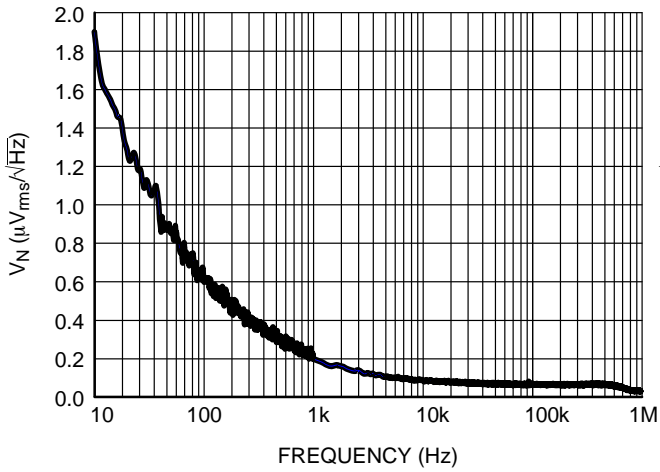

Figure 21. Output Noise vs. Frequency, 0.7 V Version

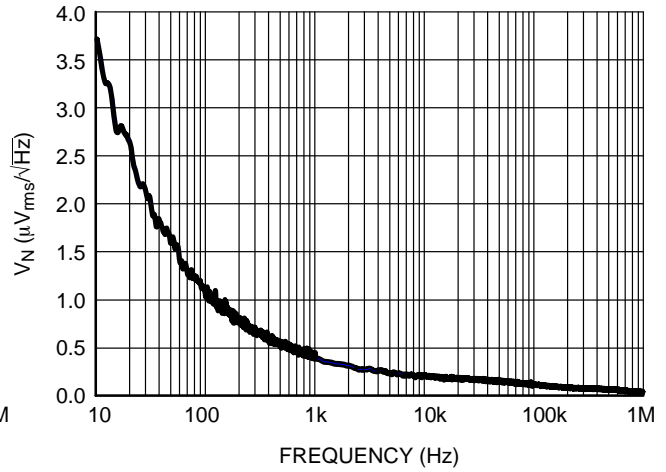

Figure 22. Output Noise vs. Frequency, 2.5 V Version

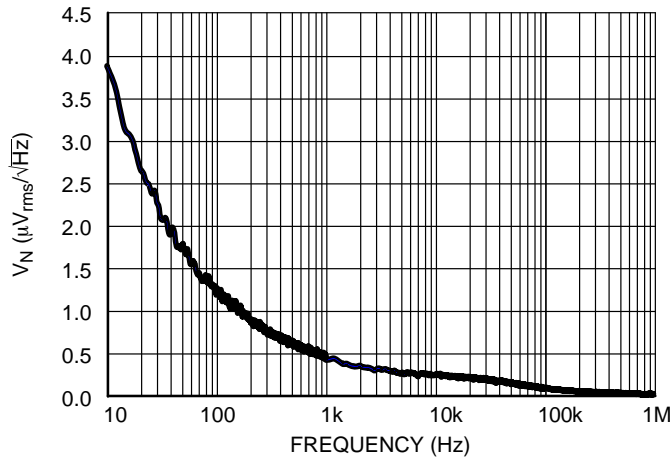

Figure 23. Output Noise vs. Frequency, 3.6 V Version

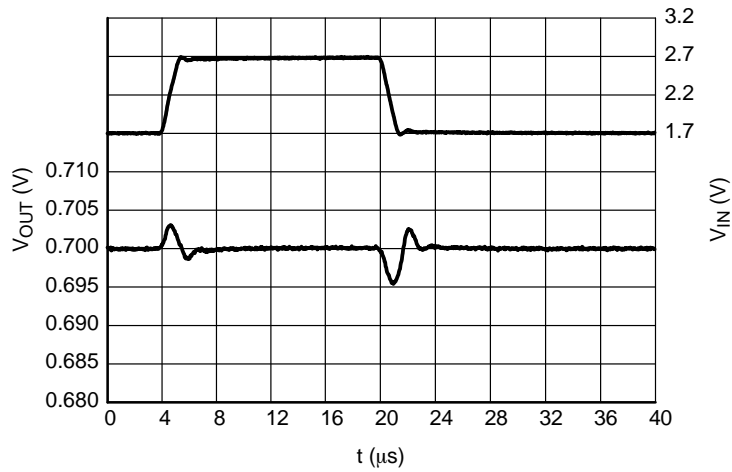

Figure 24. Line Transients, 0.7 V Version



# NCP4687

## TYPICAL CHARACTERISTICS

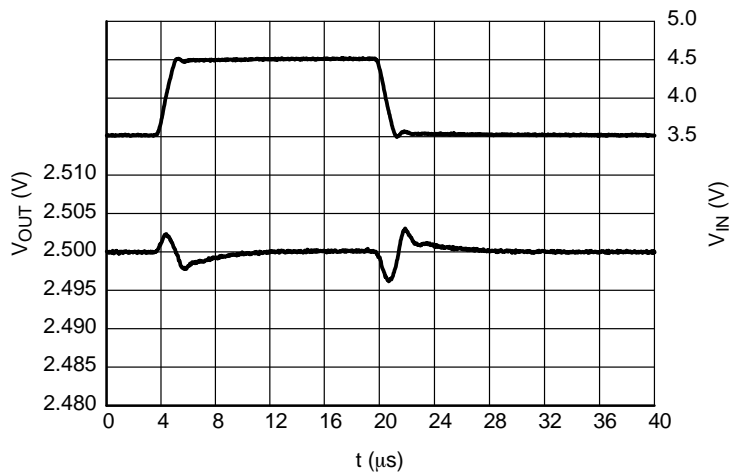

Figure 25. Line Transients, 2.5 V Version

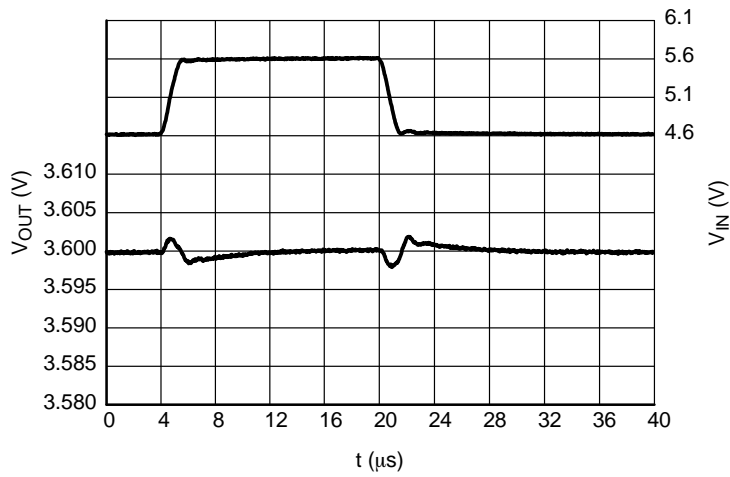

Figure 26. Line Transients, 3.6 V Version

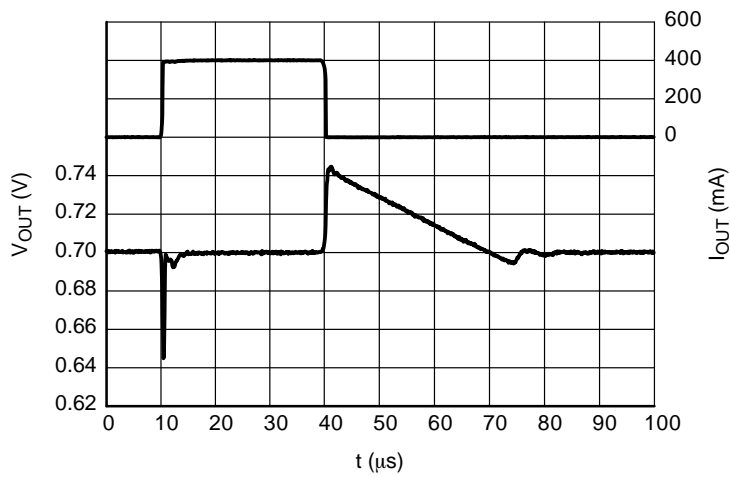
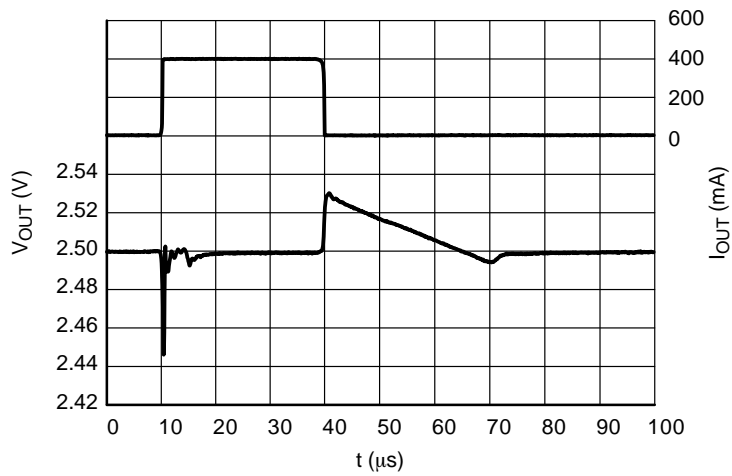

Figure 27. Load Transients, 0.7 V Version, Load Step 1 mA to 400 mA

# NCP4687

## TYPICAL CHARACTERISTICS



**Figure 28. Load Transients, 2.5 V Version, Load Step 1 mA to 400 mA**

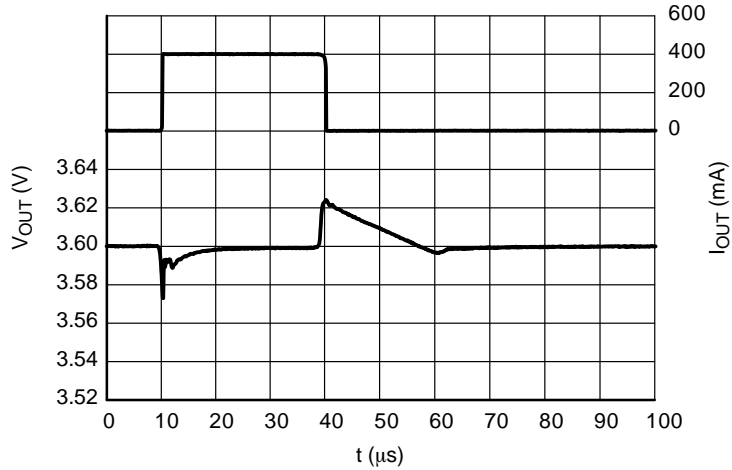

**Figure 29. Load Transients, 3.6 V Version, Load Step 1 mA to 400 mA**

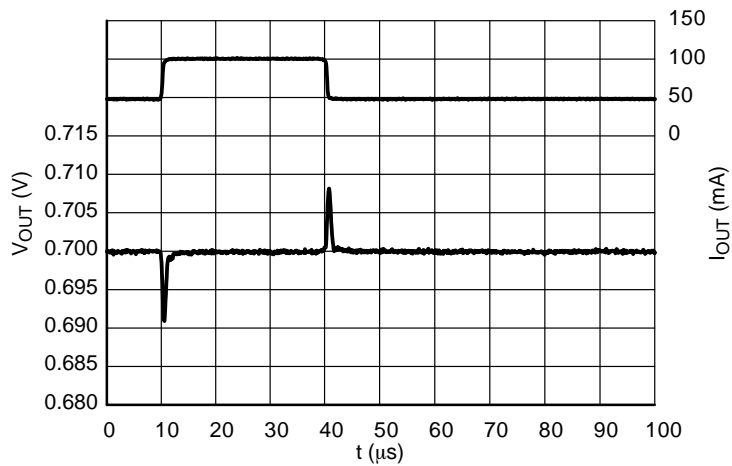

**Figure 30. Load Transients, 0.7 V Version, Load Step 50 mA to 100 mA**

# NCP4687

## TYPICAL CHARACTERISTICS

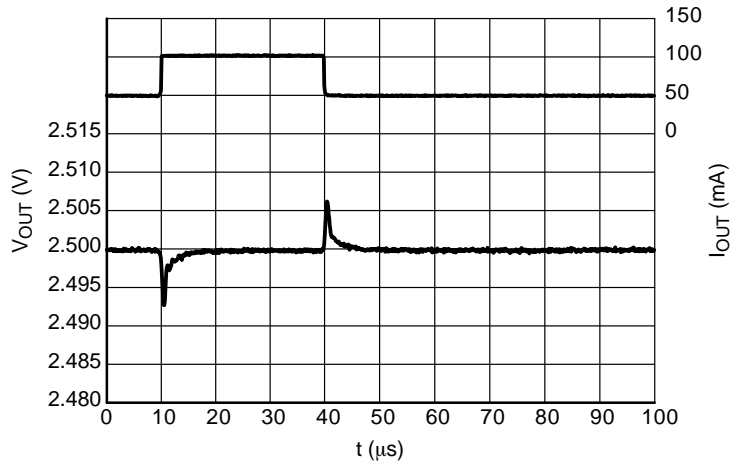

Figure 31. Load Transients, 2.5 V Version, Load Step 50 mA to 100 mA

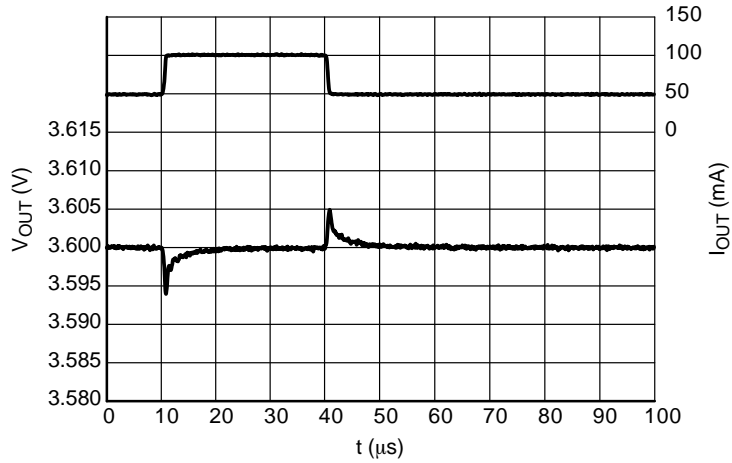

Figure 32. Load Transients, 3.6 V Version, Load Step 50 mA to 100 mA

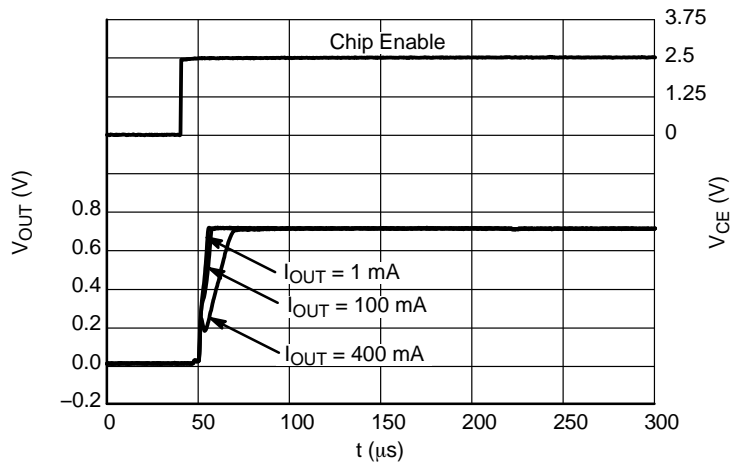

Figure 33. Turn On with CE Behavior, 0.7 V Version

# NCP4687

## TYPICAL CHARACTERISTICS

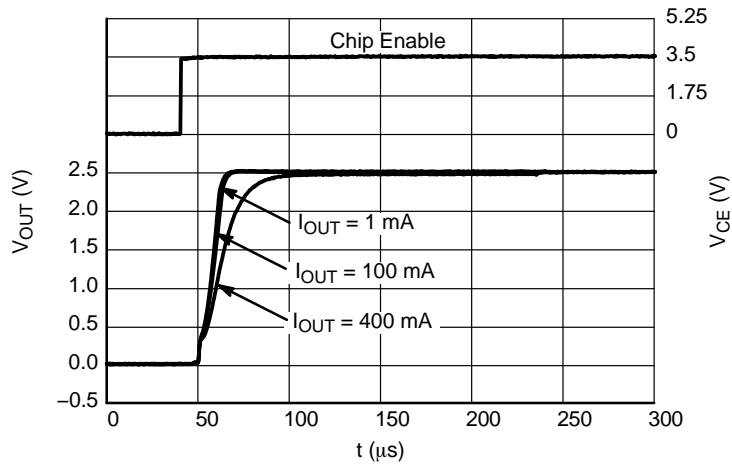

Figure 34. Turn On with CE Behavior, 2.5 V Version

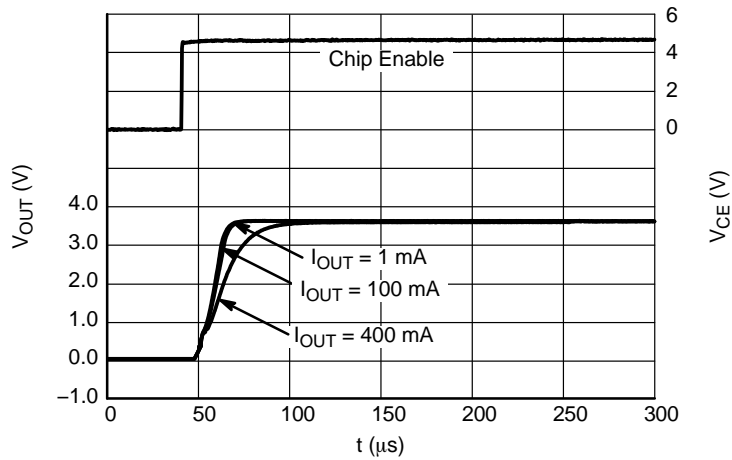

Figure 35. Turn On with CE Behavior, 3.6 V Version

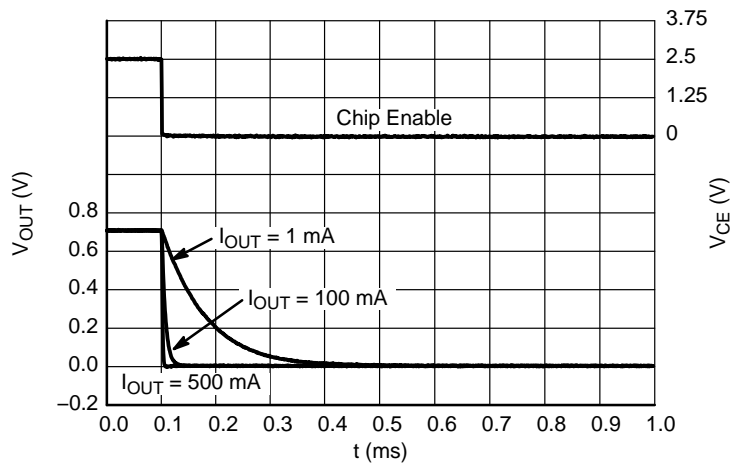

Figure 36. Turn Off with CE Behavior, 0.7 V Version

# NCP4687

## TYPICAL CHARACTERISTICS

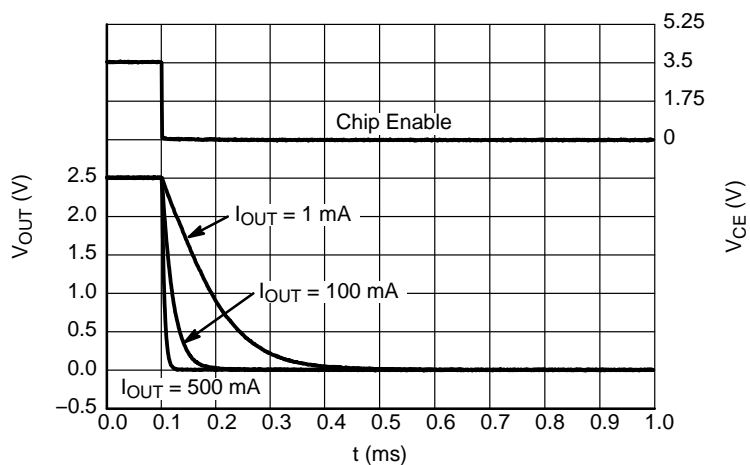

Figure 37. Turn Off with CE Behavior, 2.5 V Version

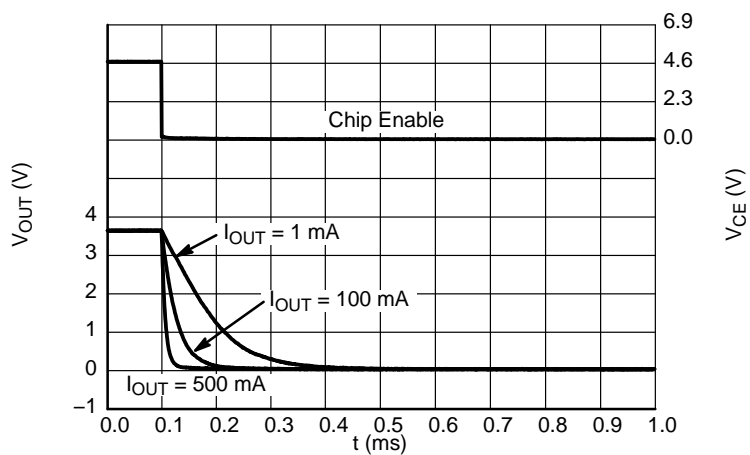

Figure 38. Turn Off with CE Behavior, 3.6 V Version

## APPLICATION INFORMATION

A typical application circuit for NCP4687 series is shown in the Figure 39.

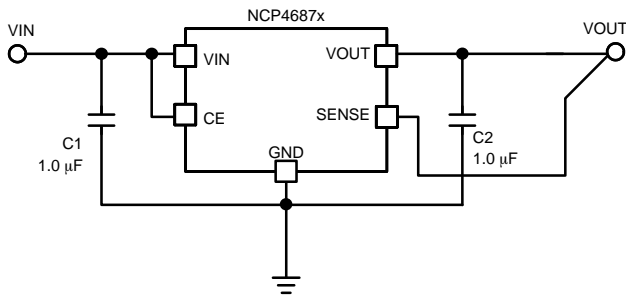

Figure 39. Typical Application Schematic

#### Input Decoupling Capacitor (C1)

A 1.0  $\mu\text{F}$  ceramic input decoupling capacitor should be connected as close as possible to the input and ground pin of the NCP4687 device. Higher values and lower ESR improves line transient response.

#### Output Decoupling Capacitor (C2)

A 1.0  $\mu\text{F}$  ceramic output decoupling capacitor is sufficient to achieve stable operation of the device. If tantalum capacitor is used, and its ESR is high, the loop oscillation may result. The capacitor should be connected as close as possible to the output and ground pin. Larger values and lower ESR improves dynamic parameters.

#### Enable Operation

The enable pin CE may be used for turning the regulator on and off. The IC is switched on when a high level voltage is applied to the CE pin. The enable pin has an internal pull

down current source which assure off state of LDO in case the CE pin will stay floating. If the enable function is not needed connect CE pin to  $V_{\text{IN}}$ .

The D version of the NCP4687 device includes a transistor between  $V_{\text{OUT}}$  and GND that is used for faster discharging of the output capacitor. This function is activated when the IC goes into disable mode.

#### Thermal Consideration

As a power across the IC increase, it might become necessary to provide some thermal relief. The maximum power dissipation supported by the device is dependent upon board design and layout. Mounting pad configuration on the PCB, the board material, and also the ambient temperature affect the rate of temperature increase for the part. When the device has good thermal conductivity through the PCB the junction temperature will be relatively low in high power dissipation applications.

The IC includes internal thermal shutdown circuit that stops operation of regulator, if junction temperature is higher than 165°C. After that, when junction temperature decreases below 100°C, the operation of voltage regulator would restart. While high power dissipation condition is, the regulator starts and stops repeatedly and protects itself against overheating.

#### Sense Pin

The SENSE pin improves significantly the load regulation. The connection resistance between the LDO and the load given by PCB parameters has reduced impact to load regulation. If possible, use wide PCB traces as short as possible.

# NCP4687

## ORDERING INFORMATION

| Device          | Marking | Nominal Output Voltage | Feature        | Package             | Shipping <sup>†</sup> |
|-----------------|---------|------------------------|----------------|---------------------|-----------------------|
| NCP4687DH12T1G  | A12D    | 1.2 V                  | Auto discharge | SOT-89<br>(Pb-Free) | 1000 / Tape & Reel    |
| NCP4687DH15T1G  | A15D    | 1.5 V                  | Auto discharge | SOT-89<br>(Pb-Free) | 1000 / Tape & Reel    |
| NCP4687DH18T1G  | A18D    | 1.8 V                  | Auto discharge | SOT-89<br>(Pb-Free) | 1000 / Tape & Reel    |
| NCP4687DH25T1G  | A25D    | 2.5 V                  | Auto discharge | SOT-89<br>(Pb-Free) | 1000 / Tape & Reel    |
| NCP4687DH33T1G  | A33D    | 3.3 V                  | Auto discharge | SOT-89<br>(Pb-Free) | 1000 / Tape & Reel    |
| NCP4687DMX18TCG | 9P      | 1.8 V                  | Auto discharge | XDFN6<br>(Pb-Free)  | 5000 / Tape & Reel    |
| NCP4687DMX25TCG | 9X      | 2.5 V                  | Auto discharge | XDFN6<br>(Pb-Free)  | 5000 / Tape & Reel    |
| NCP4687DMX33TCG | 0G      | 3.3 V                  | Auto discharge | XDFN6<br>(Pb-Free)  | 5000 / Tape & Reel    |
| NCP4687DSN18T1G | J18     | 1.8 V                  | Auto discharge | SOT-23<br>(Pb-Free) | 3000 / Tape & Reel    |
| NCP4687DSN25T1G | J25     | 2.5 V                  | Auto discharge | SOT-23<br>(Pb-Free) | 3000 / Tape & Reel    |
| NCP4687DSN28T1G | J28     | 2.8 V                  | Auto discharge | SOT-23<br>(Pb-Free) | 3000 / Tape & Reel    |

<sup>†</sup>For information on tape and reel specifications, including part orientation and tape sizes, please refer to our Tape and Reel Packaging Specifications Brochure, BRD8011/D.

# NCP4687

## PACKAGE DIMENSIONS

### SOT-23 5-LEAD CASE 1212 ISSUE A

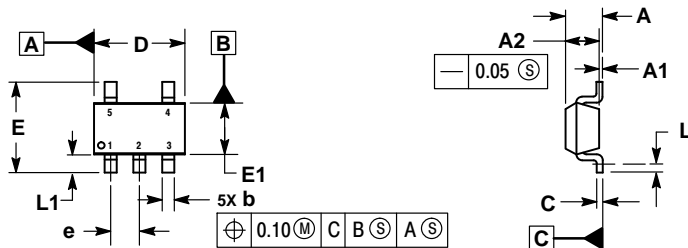

- NOTES:
1. DIMENSIONING AND TOLERANCING PER ASME Y14.5M, 1994.
  2. CONTROLLING DIMENSIONS: MILLIMETERS.
  3. DATUM C IS THE SEATING PLANE.

| MILLIMETERS |          |      |
|-------------|----------|------|
| DIM         | MIN      | MAX  |
| A           | ---      | 1.45 |
| A1          | 0.00     | 0.10 |
| A2          | 1.00     | 1.30 |
| b           | 0.30     | 0.50 |
| c           | 0.10     | 0.25 |
| D           | 2.70     | 3.10 |
| E           | 2.50     | 3.10 |
| E1          | 1.50     | 1.80 |
| e           | 0.95 BSC |      |
| L           | 0.20     | ---  |
| L1          | 0.45     | 0.75 |

### RECOMMENDED SOLDERING FOOTPRINT\*

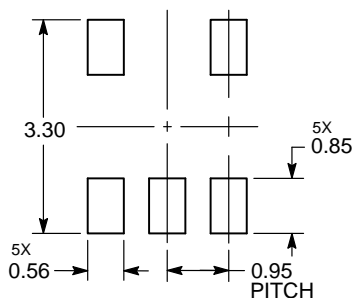

DIMENSIONS: MILLIMETERS

\*For additional information on our Pb-Free strategy and soldering details, please download the ON Semiconductor Soldering and Mounting Techniques Reference Manual, SOLDERRM/D.



# NCP4687

## PACKAGE DIMENSIONS

XDFN6 1.20x1.20, 0.40P  
CASE 711AH  
ISSUE O

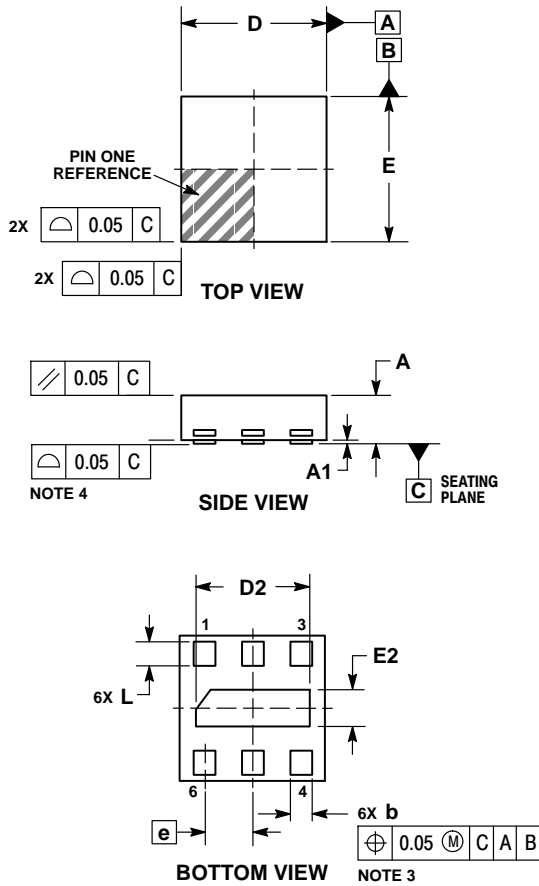

NOTES:

1. DIMENSIONING AND TOLERANCING PER ASME Y14.5M, 1994.
2. CONTROLLING DIMENSION: MILLIMETERS.
3. DIMENSION b APPLIES TO PLATED TERMINAL AND IS MEASURED BETWEEN 0.15 AND 0.25mm FROM TERMINAL TIPS.
4. COPLANARITY APPLIES TO ALL OF THE TERMINALS.

| DIM | MILLIMETERS |      |
|-----|-------------|------|
|     | MIN         | MAX  |
| A   | ---         | 0.40 |
| A1  | 0.00        | 0.05 |
| b   | 0.13        | 0.23 |
| D   | 1.20 BSC    |      |
| D2  | 0.89        | 0.99 |
| E   | 1.20 BSC    |      |
| E2  | 0.25        | 0.35 |
| e   | 0.40 BSC    |      |
| L   | 0.15        | 0.25 |
| L1  | 0.05 BSC    |      |

### RECOMMENDED MOUNTING FOOTPRINT\*

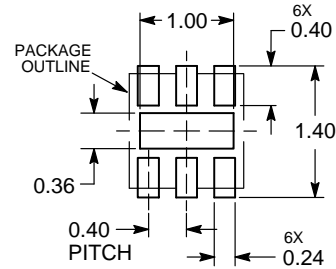

DIMENSIONS: MILLIMETERS

\*For additional information on our Pb-Free strategy and soldering details, please download the ON Semiconductor Soldering and Mounting Techniques Reference Manual, SOLDERRM/D.

# NCP4687

## PACKAGE DIMENSIONS

### SOT-89, 5 LEAD CASE 528AB ISSUE O

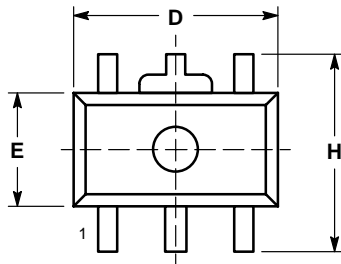

TOP VIEW

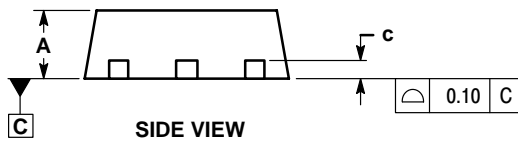

SIDE VIEW

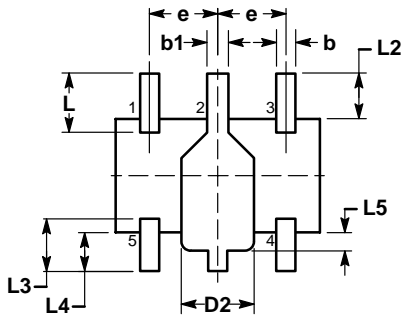

BOTTOM VIEW

NOTES:

1. DIMENSIONING AND TOLERANCING PER ASME Y14.5M, 1994.
2. CONTROLLING DIMENSION: MILLIMETERS.
3. LEAD THICKNESS INCLUDES LEAD FINISH.
4. DIMENSIONS D AND E DO NOT INCLUDE MOLD FLASH, PROTRUSIONS, OR GATE BURRS.
5. DIMENSIONS L, L2, L3, L4, L5, AND H ARE MEASURED AT DATUM PLANE C.

| DIM | MILLIMETERS |      |
|-----|-------------|------|
|     | MIN         | MAX  |
| A   | 1.40        | 1.60 |
| b   | 0.32        | 0.52 |
| b1  | 0.37        | 0.57 |
| c   | 0.30        | 0.50 |
| D   | 4.40        | 4.60 |
| D2  | 1.40        | 1.80 |
| E   | 2.40        | 2.60 |
| e   | 1.40        | 1.60 |
| H   | 4.25        | 4.45 |
| L   | 1.10        | 1.50 |
| L2  | 0.80        | 1.20 |
| L3  | 0.95        | 1.35 |
| L4  | 0.65        | 1.05 |
| L5  | 0.20        | 0.60 |

### RECOMMENDED MOUNTING FOOTPRINT\*

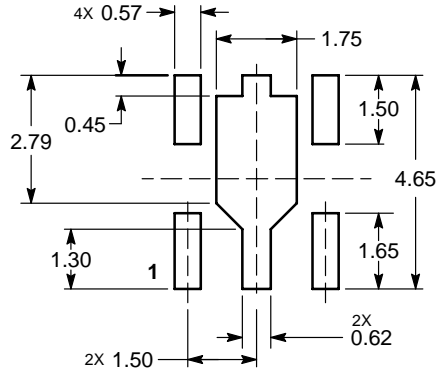

DIMENSIONS: MILLIMETERS

\*For additional information on our Pb-Free strategy and soldering details, please download the ON Semiconductor Soldering and Mounting Techniques Reference Manual, SOLDERRM/D.

ON Semiconductor and are registered trademarks of Semiconductor Components Industries, LLC (SCILLC). SCILLC reserves the right to make changes without further notice to any products herein. SCILLC makes no warranty, representation or guarantee regarding the suitability of its products for any particular purpose, nor does SCILLC assume any liability arising out of the application or use of any product or circuit, and specifically disclaims any and all liability, including without limitation special, consequential or incidental damages. "Typical" parameters which may be provided in SCILLC data sheets and/or specifications can and do vary in different applications and actual performance may vary over time. All operating parameters, including "Typicals" must be validated for each customer application by customer's technical experts. SCILLC does not convey any license under its patent rights nor the rights of others. SCILLC products are not designed, intended, or authorized for use as components in systems intended for surgical implant into the body, or other applications intended to support or sustain life, or for any other application in which the failure of the SCILLC product could create a situation where personal injury or death may occur. Should Buyer purchase or use SCILLC products for any such unintended or unauthorized application, Buyer shall indemnify and hold SCILLC and its officers, employees, subsidiaries, affiliates, and distributors harmless against all claims, costs, damages, and expenses, and reasonable attorney fees arising out of, directly or indirectly, any claim of personal injury or death associated with such unintended or unauthorized use, even if such claim alleges that SCILLC was negligent regarding the design or manufacture of the part. SCILLC is an Equal Opportunity/Affirmative Action Employer. This literature is subject to all applicable copyright laws and is not for resale in any manner.

### PUBLICATION ORDERING INFORMATION

**LITERATURE FULFILLMENT:**

Literature Distribution Center for ON Semiconductor  
P.O. Box 5163, Denver, Colorado 80217 USA  
Phone: 303-675-2175 or 800-344-3860 Toll Free USA/Canada  
Fax: 303-675-2176 or 800-344-3867 Toll Free USA/Canada  
Email: orderlit@onsemi.com

**N. American Technical Support:** 800-282-9855 Toll Free  
USA/Canada  
**Europe, Middle East and Africa Technical Support:**  
Phone: 421 33 790 2910  
**Japan Customer Focus Center**  
Phone: 81-3-5817-1050

**ON Semiconductor Website:** [www.onsemi.com](http://www.onsemi.com)

**Order Literature:** <http://www.onsemi.com/orderlit>

For additional information, please contact your local Sales Representative