



ProxSense[®] IQS263 Datasheet

3 Channel Capacitive Touch and Proximity Controller with 8-bit Resolution Slider or Scroll Wheel

The **IQS263** ProxSense[®] IC is a 3-channel projected (or self) capacitive proximity and touch controller with best in class sensitivity, signal to noise ratio and power consumption. Other features include automatic tuning for sense electrodes, internal reference capacitor and internal regulator to reduce total system cost.

Main Features

- 3 Self or Mutual Channel Capacitive Controller
- Configurable 8-bit 2/3 channel slider or 3 channel scroll wheel
- Up to 80Hz report rate
- On chip Movement Detection algorithm
- SAR compliance in mobile devices according to the IEC 62209-2 ed1.0 standard and the FCC standard (KDB 616217 – D04 SAR for laptop and tablets v01)
- Left and right flick gesture recognition
- Automatic adjustment for optimal performance (ATI)
- User selectable Proximity and Touch thresholds
- Long proximity range
- Automatic drift compensation
- Fast I²C Interface
- Event mode or Streaming modes
- Hibernation mode
- Low Power, suitable for battery applications
- Supply voltage: 1.8V to 3.6V
- <3μA Active sensing in LP mode
- <100μA full running current up to 40Hz report rate

RoHS2
Compliant

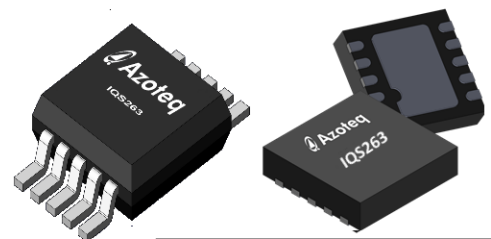

IQS263 MSOP10 / DFN 10
Representations only, not actual markings

Applications

- SAR detection for tablets and mobile phones
- SAR detection for wireless charging stations (operating frequency > 100MHz)
- SAR detection for USB dongle-type devices
- Sliders/Scroll wheels for remote controls
- Movement detection devices (anti-theft)
- Volume Control & Lid closure detection for laptops
- MP3 players
- Portable Electronics
- Wearable Electronics

Available Options

T _A	MSOP10	DFN10 (3x3)
-20°C to 85°C	IQS263	IQS263



Contents

1	INTRODUCTION	3
2	ANALOGUE FUNCTIONALITY.....	3
3	DIGITAL FUNCTIONALITY	3
4	PASSING THE SAR QUALIFICATION TESTING	4
5	HARDWARE CONFIGURATION	4
6	USER CONFIGURABLE OPTIONS.....	9
7	SLIDERS/WHEEL COORDINATE TO POSITION MAPPING.....	18
8	PROXSENSE [®] MODULE	21
9	COMMUNICATION	26
10	COMMUNICATION COMMAND/ADDRESS STRUCTURE	28
11	SPECIFICATIONS	39
12	PACKAGING INFORMATION	42
13	DEVICE MARKING.....	48
14	ORDERING INFORMATION	49

Revision History

Version	Description	Date
1.00	First Release	Jan 2014
1.01	Update Package Marking	Jun 2014
1.02	Add section for coordinate mapping	Aug 2014
1.03	Update I2C time-out descriptions	Nov 2014
1.04	Add DFN10 (3x3) descriptions	Jan 2015
1.05	Update to self-capacitive reference design, add ATI times	March 2015
1.06	Update Delta Description	May 2015
1.07	Updated Electrical Specifications	October 2015
1.08	Update DFN Package Diagrams	Nov 2015
1.09	Add description of input pin function	Jan 2016
1.10	Update reference schematic for ESD	September 2016
1.11	Update WDT and Comms timeout	October 2016
1.12	Update Temperature rating to -20°C	



Functional Overview

1 Introduction

The **IQS263** is a 3 channel projected (or self) capacitive proximity and touch sensor featuring an internal voltage regulator and reference capacitor (C_S).

The device has 4 possible pins for the connection of the sense electrodes, which consist of 3 Self electrodes, or 3 receivers and 1 transmitter. Three pins are used for serial data communication through the I²C™ compatible protocol, including an optional RDY pin. The transmitter pin can also be used as an I/O for output upon proximity detection when the device is used in Self capacitive mode.

The device automatically tracks slow varying environmental changes via various filters, detects noise and is equipped with an Automatic Tuning Implementation (ATI) to adjust the device for optimal sensitivity.

1.1 Applicability

All specifications, except where specifically mentioned otherwise, provided by this datasheet are applicable to the following ranges:

- Temperature -20°C to +85°C
- Supply voltage (V_{DDHI}) 1.8V to 3.6V

1.2 Device Operation

With a normal activation (hand brought close) the output bit(s) will become active. These outputs will clear as soon as the action is reversed (hand taken away). In addition a separate movement output will become active when movement is detected according to a movement threshold. Movement may be detected before the normal touch threshold is crossed. Movement detection is done via a completely separate digital filter.

2 Analogue Functionality

CRX and CTX electrodes are arranged in a suitable configuration that results in a mutual

capacitance (C_m) between the two electrodes. CTX is charged up to a set positive potential during a charge cycle which results in a negative charge buildup at CRX.

The resulting charge displacement is then measured within the **IQS263** device through a charge transfer process that is periodically initiated by the digital circuitry. The capacitance measurement circuitry makes use of an internal reference capacitor C_S and voltage reference (V_{REF}).

The measuring process is referred to as a conversion and consists of the discharging of C_s and C_x capacitors, the charging of C_x and then a series of charge transfers from C_x to C_s until a trip voltage is reached. The number of charge transfers required to reach the trip voltage is referred to as the Counts (CS) value.

The analogue circuitry further provides functionality for:

- Power On Reset (POR) detection.
- Brown Out Detection (BOD).
- Internal regulation provides for accurate sampling.

3 Digital Functionality

The digital processing functionality is responsible for:

- Managing BOD and WDT events.
- Initiation of conversions at the selected rate.
- Processing of CS and execution of algorithms.
- Monitoring and execution of the ATI algorithm.
- Signal processing and digital filtering.
- Detection of PROX and TOUCH events.
- Managing outputs of the device.
- Managing serial communications.



4 Passing the SAR Qualification Testing

The IQS263 offers a new ATA algorithm that ensures reliable consistent entry and exit distances of user events which are ideal for passing SAR test. Furthermore, the IQS263 offers a movement monitoring algorithm, to help the host controller distinguish between long term user activations and stuck conditions.

For design information on passing the SAR qualification testing with Azoteq movement based sensors, please see the application note: "[AZD073 SAR qualification with Azoteq movement-based sensors.](#)"

5 Hardware Configuration

The IQS263 can be configured to charge in Self- or Projected-Capacitive mode through the memory map by the host controller. The IQS263 is default in Self Capacitive mode, and can be set to Projected-Capacitive mode by setting the "Proj Mode" bit in [Register 0x01](#), byte 0.

In **Self Capacitive** mode, the IQS263 has 3 channels. It can be used as 3 discrete buttons OR as a slider. It will also have a proximity output available.

In **Projected-Capacitive** mode, the IQS263 has 3 channels. It can be used as 3 discrete buttons OR a slider but no proximity output will be available.

5.1 IQS263 Pin Out

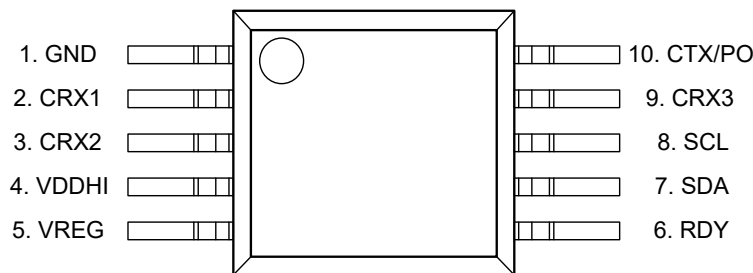

Figure 5.1 IQS263 Pin out in MSOP-10.

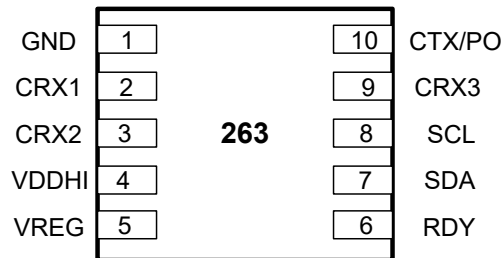

Figure 5.2 IQS263 Pin out in DFN10.

Table 5.1 IQS263 MSOP-10 & DFN10 Pin-outs.

Pin	Self-Capacitive	Projected-Capacitive	Function
1	GND	GND	Ground
2	CX1	Rx1	Sensor Electrode
3	CX2	Rx2	Sensor Electrode
4	VDDHI	VDDHI	Power Supply
5	VREG	VREG	Regulated Output
6	RDY	RDY	Communication Interrupt
7	SDA	SDA	Serial Data
8	SCL	SCL	Serial Clock
9	CX3	Rx3	Sensor Electrode
10	PO	Tx	Prox Out/Sensor Electrode



5.2 Reference Design

5.2.1 Projected Schematic

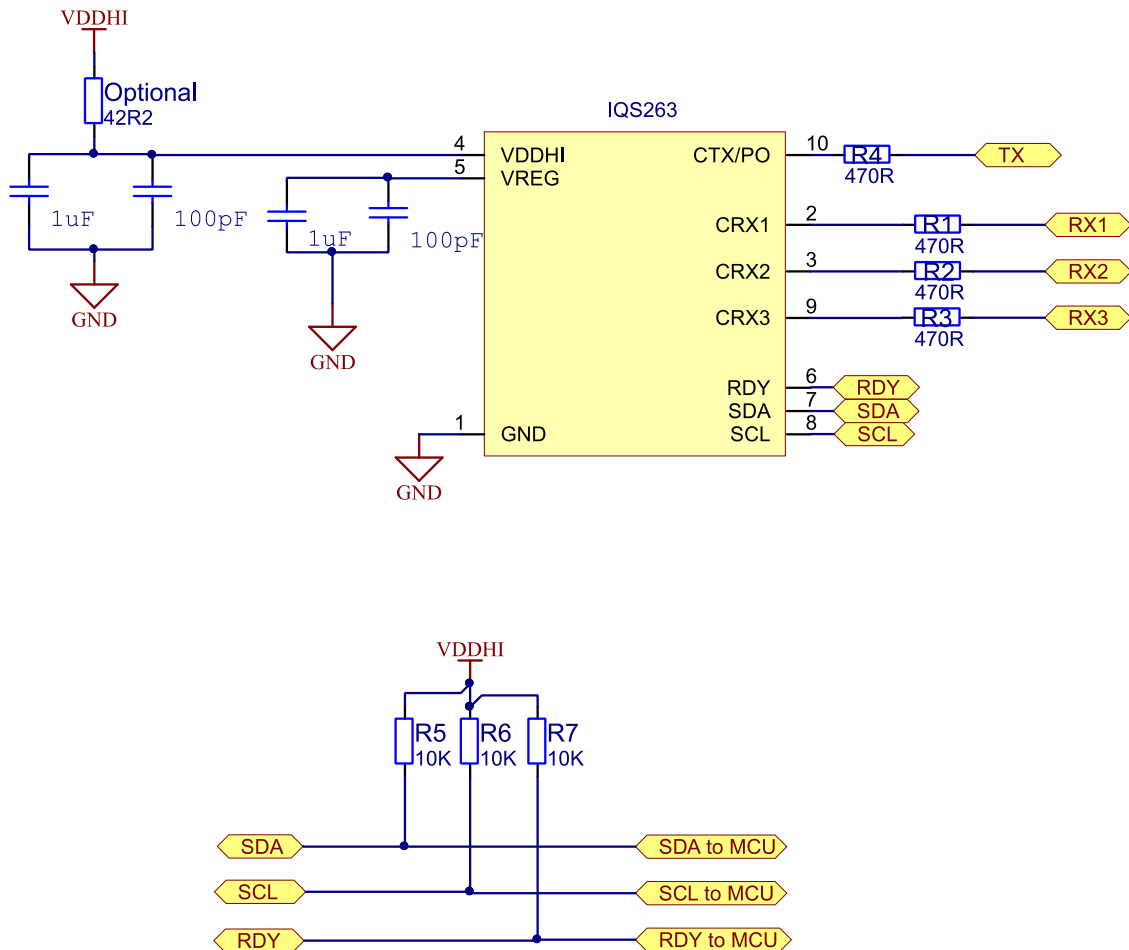

Figure 5.3 IQS263 projected capacitive reference design.

5.2.2 Projected Electrodes

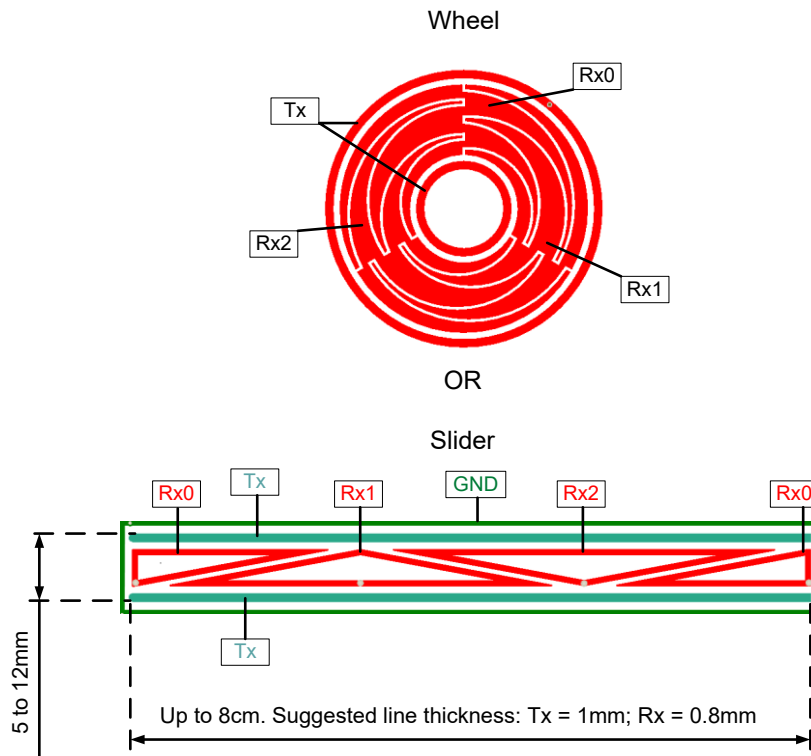

Figure 5.4 Example layout of projected wheel OR slider that wraps around – 0 to 255 coordinates available.

5.2.3 Example Routing

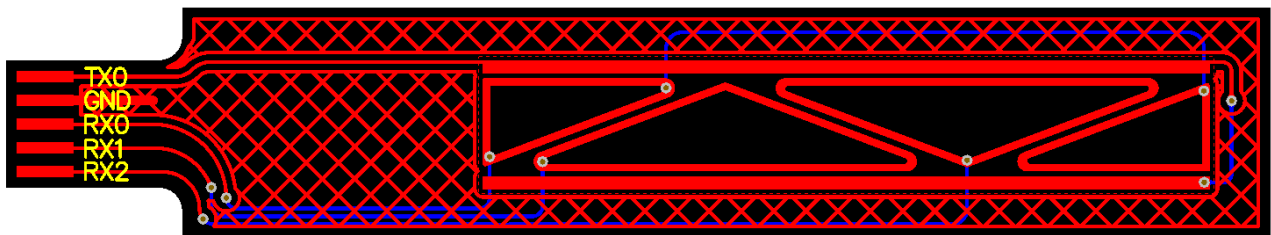

Figure 5.5 Example routing of a projected slider. GND on top layer shields the Rx lines from the user on the bottom layer.

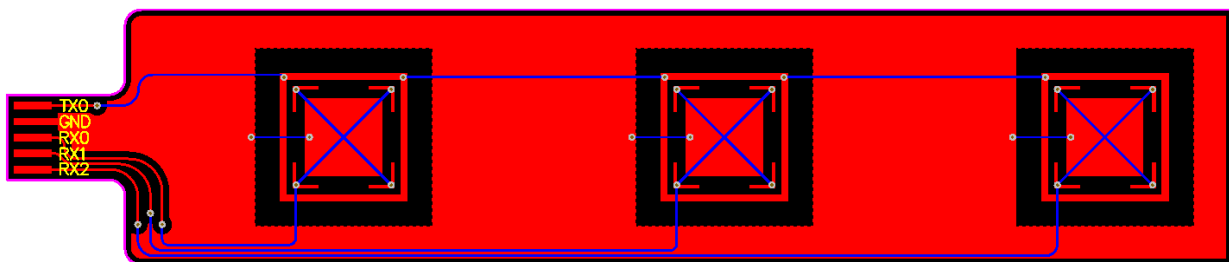

Figure 5.6 Example routing of 3 discrete buttons. These buttons are suggested for application requiring high noise immunity.



5.2.4 Projected Setup

For both the wheel and slider shown in Figure 5.4 the **IQS263** slider setup in ProxSettings1 must be set to the “Wheel” selection (Bit3:2 as 10).

The slider setup of the **IQS263** in ProxSettings1 for the 3 discrete keys such as shown in Figure 5.6 can be set to “3CH Slider” selection (Bit3:2 as 11). Since the buttons have no interleaving, the coordinate tracking will not be linear. However, recognising flick events will still be achieved.

5.2.5 Self Schematic

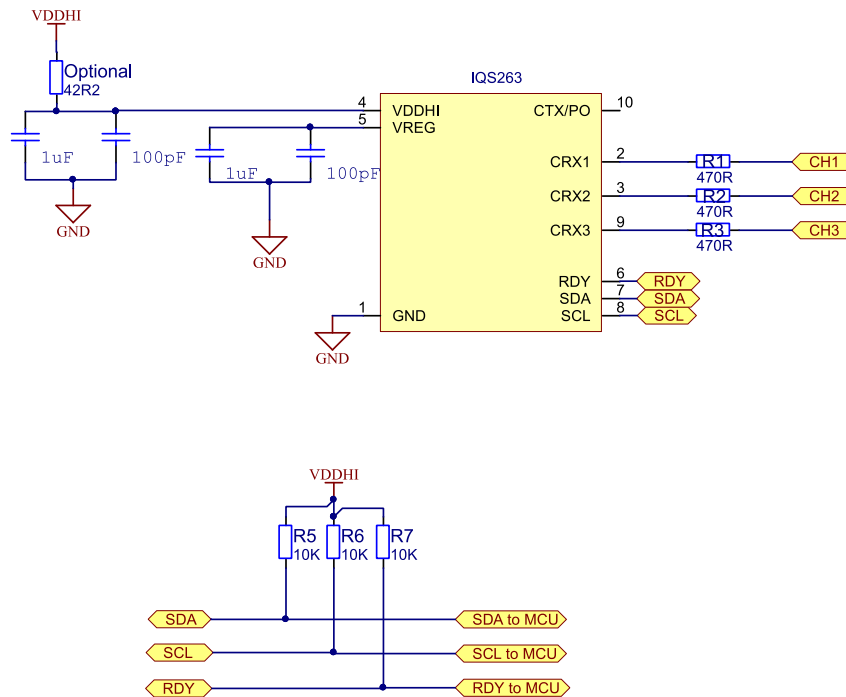

Figure 5.7 IQS263 self-capacitive reference design.

5.2.6 Self Electrodes

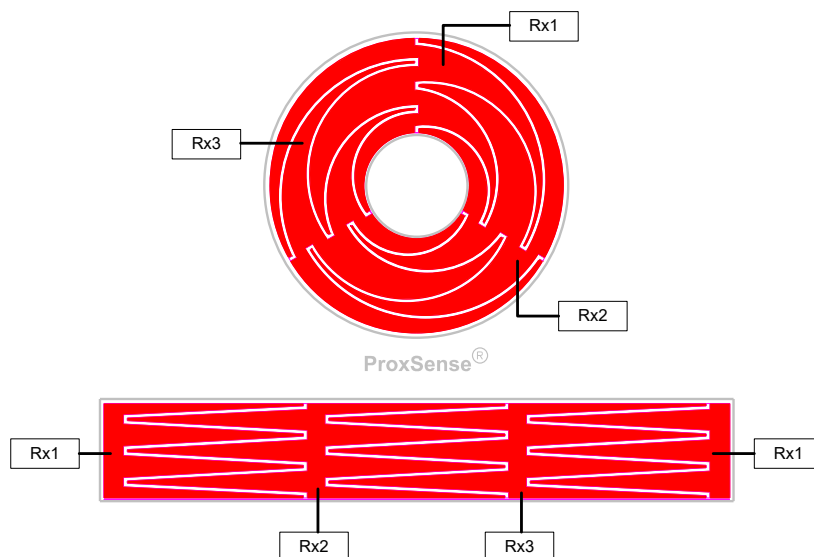

Figure 5.8 Example of a 3 Channel Self capacitive wheel and slider. Suggested gaps between electrodes ≥ 0.8mm.

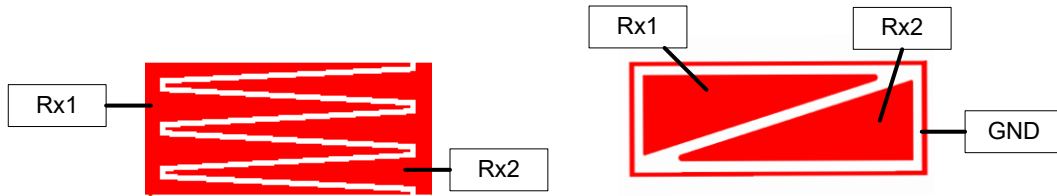

Figure 5.9 Examples of 2 Channel Self capacitive sliders.
Suggested gaps between electrodes $\geq 0.8\text{mm}$.

5.2.7 Self Setup

For both the wheel and slider shown in Figure 5.8 the **IQS263** slider setup in ProxSettings1 must be set to the “Wheel” selection (Bit3:2 as 10).

For the slider shown in Figure 5.9 the **IQS263** slider setup in ProxSettings1 must be set to the “2CH slider” selection (Bit3:2 as 01).

5.3 Power Supply and PCB Layout

Azoteq IC's provide a high level of on-chip hardware and software noise filtering and ESD protection (refer to application note “**AZD013 – ESD Overview**”). Designing PCB's with better noise immunity against EMI, FTB and ESD in mind, it is always advisable to keep the critical noise suppression components like the de-coupling capacitors and series resistors in **Figure 5.3** as close as possible to the IC. Always maintain a good ground connection and ground pour underneath the IC. For more guidelines please refer to the relevant application notes as mentioned in **Section 5.4**.

Where a system level ESD strike is found to cause the IC to go into ESD induced latch-up, it is suggested that the supply current to the IQS263 IC is limited by means of a series resistor that could limit the maximum supply current to the IC to $<80\text{mA}$.



5.4 Design Rules for Harsh EMC Environments

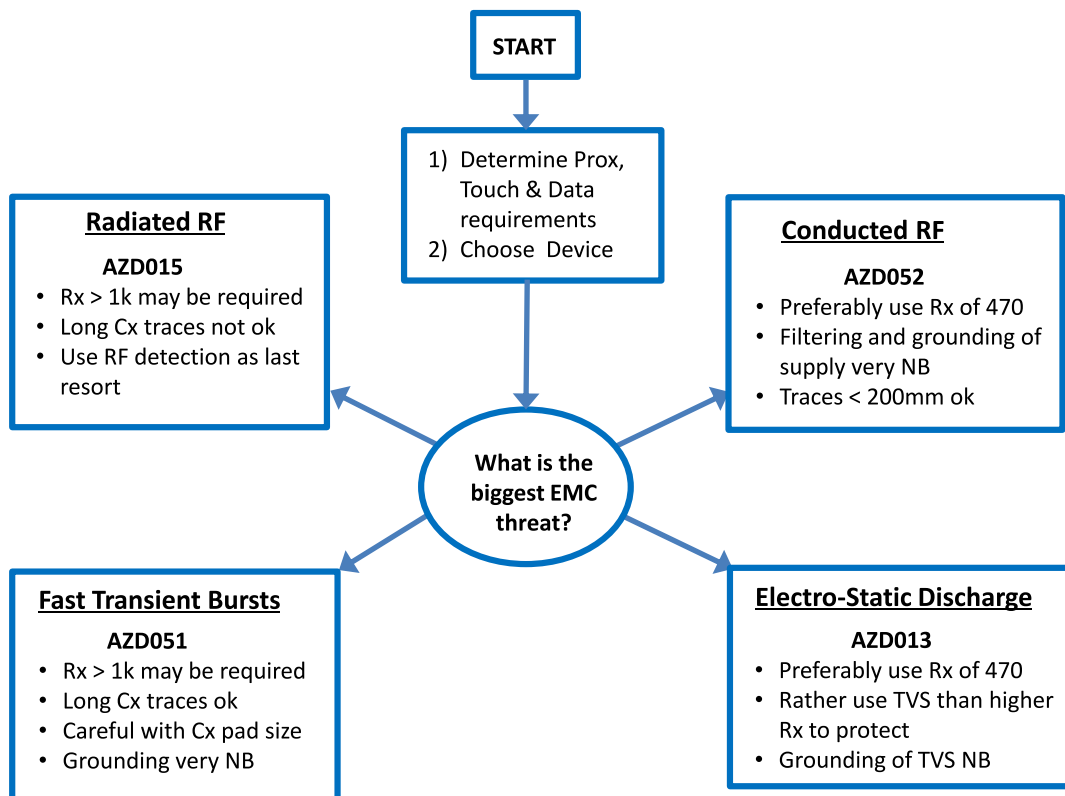

➤ **Applicable application notes: AZD013, AZD015, AZD051, and AZD052.**

5.5 High Sensitivity

Through patented design and advanced signal processing, the device is able to provide extremely high sensitivity to detect proximity. This enables designs to detect proximity at distances that cannot be equaled by most other products. When the device is used in environments where high levels of noise or floating metal objects exist, a reduced proximity threshold is proposed to ensure reliable functioning of the sensor. The high sensitivity also allows the device to sense through overlay materials with low dielectric constants, such as wood or porous plastics.

For more guidelines on the layout of capacitive sense electrodes, please refer to application note **AZD008**, available on the Azoteq web page: www.azoteq.com.

6 User Configurable Options

The **IQS263** requires configuration by a master/host controller or MCU. The user needs to select the number of channels and corresponding touch and proximity thresholds.

6.1 Setup

6.1.1 Self and Projected Modes

The **IQS263** can function as a Self or Projected capacitive controller, depending on the application requirement. The **IQS263** is default in Self capacitive mode. Pre-configured devices can be ordered for projected mode, or the user can select the operation mode as projected during



initialization by setting the “Proj Mode” bit in the [System Flags register \(0x01H; byte 0\)](#).

6.1.2 Global Filter Halt

By default the **IQS263** implements a global filter halt. This realizes that all LTA filters are frozen upon any proximity or touch detection. This optimizes sensitivity by reducing the risk of desensitizing of touch channels during user operation, especially for slider functions.

It is, however, possible to disable the global filter halt, whereby each channel will halt its own LTA upon a detection of an undebounced event on that channel. To disable the global filter halt, the user must set the “Ind Halt” bit in the [System Flags register \(0x01H; byte 0\)](#).

6.2 ProxSetting0

6.2.1 Disable ATI

The **IQS263** has the ability to automatically retune sensor electrodes when the counts drift outside a pre-defined [ATI band](#). This allows the **IQS263** to keep optimal sensitivity during different environment. To disable the feature, the “ATI OFF” bit needs to be set in the [ProxSettings0 register \(0x09; byte 0\)](#). Disabling this feature only disables the automatic retuning; the MCU can at any time still force retuning with the [Redo-ATI](#) command.

6.2.2 Partial ATI

If it is required to have the ATI time reduced, the **IQS263** can use partial ATI by setting the “ATI Partial” bit in the [ProxSettings0 register \(0x09; byte 0\)](#). The designer must also specify the sensitivity multiplier (option 1 to 4) as the **IQS263** will only calculate the compensation multiplier and compensation. The Partial ATI option reduces start-up and re-tuning times, but does require the designer to verify that the base values achieved are within the desired range.

6.2.3 ATI Band

The user has the option to select the re-tuning band as $\frac{1}{4}$ of the ATI target (default

is $\frac{1}{8}$ of the ATI target) if it is desired to have a wider range for the counts to drift with environmental change before the device retune the electrodes. The wider band is achieved by setting the “ATI BAND” bit in the [ProxSettings0 register \(0x09; byte 0\)](#).

6.2.4 Stream ATI

In order to facilitate faster start-up and re-tuning times, the communication windows are stopped during ATI on the **IQS263**. If the designer would like to be able to read data after every charge cycle during ATI, the communication can be enabled by setting the “Stream ATI” bit in the [ProxSettings0 register \(0x09; byte 0\)](#). A communication window can still be forced by the MCU with a RDY handshake (pulling the RDY line low) at any time even if the “Stream ATI” bit is not set.

6.2.5 Oscillator

The **IQS263** response times can be increased (at the cost of higher current consumption) by setting the internal oscillator at 4MHz (default 2MHz). The faster speed is enabled by setting the “4MHz” bit in the [ProxSettings0 register \(0x09; byte 0\)](#).

6.2.6 Redo-ATI

The **IQS263** can be forced to ATI at any time, regardless of present events. To force retuning set the “Redo ATI” bit in the [ProxSettings0 register \(0x09; byte 0\)](#). The “Redo ATI” bit will automatically clear after having been set.

6.2.7 Reseed

The **IQS263** LTA filters can be reseeded to the count values at any time to clear any output event. If count values are outside the ATI band, retuning will be triggered. To reseed set the “Reseed” bit in the [ProxSettings0 register \(0x09; byte 0\)](#). The “Reseed” bit will automatically clear after having been set.

Setting the Reseed bit will shift all LTA filters to a value of $LTA_{new} = CS + 8 (CS - 8$



for Self). The LTA will then track the CS value until they are even.

Performing a reseed action on the LTA filters, will effectively clear any proximity and/or touch conditions that may have been established prior to the reseed call.

6.2.8 Force Halt

The user has the option to halt the LTA to avoid any reseed or re-tuning events from taking place. This can be used in situations where the counts are expected to go in the wrong direction as a result of a controlled action in the application. To freeze the LTA filters set the “Force Halt” bit in the [ProxSettings0 register \(0x09; byte 0\)](#).

6.3 ProxSettings1

6.3.1 WDT Disable

The WDT (watchdog timer) is used to reset the IC if a problem (for example a voltage spike) occurs during communication. The WDT will time-out (and thus reset the device) after t_{WDT} if no valid communication occurred during this time.

The WDT can be disabled during development by setting the “WDT Off” bit in the [ProxSettings1 register \(0x09; byte 1\)](#). It is not recommended to disable the WDT for production.

6.3.2 Event Mode

By default the device operates in full streaming mode. There is an option for an event-driven I²C communication mode (also called “Event Mode”), with the RDY pin ONLY indicating a communication window after a prescribed event has occurred.

These events include:

- Flicks (left and/or right)
- Tap
- Movement
- ATI
- Slider
- Touch
- Proximity

The RDY pin will indicate events in the following manner:

1. **Flick/Swipe Detected:** Single RDY low on flick left or right
2. **Tap Detected:** Single RDY low
3. **Movement occurring:** Single RDY low on movement event
4. **ATI:** RDY low on ATI start & again on ATI completing
5. **Slider or Wheel:** RDY pin low after completion of every charge cycle while a touch remains detected on a wheel/slider channel.
6. **Touch:** RDY low on each touch entry and exit occurring.
7. **Prox:** RDY low on entry and exit

If the wheels/sliders are enabled, the device will stream data continuously (after every charge cycle) when a touch is present on one of the wheel/slider channels, even if Event Mode is enabled.

Event Mode can be enabled by setting the “Event Mode” bit in the [ProxSettings1 register \(0x09; byte 1\)](#).

Note: The device is also capable of functioning **without** a RDY line on a polling basis.

6.3.3 LTA Beta

The speed at which the LTA will follow the counts when no event is present (no filter halt) can be changed by adjusting the beta values for the LTA filter. Four options are available by setting the “LTA Beta” bits in the [ProxSettings1 register \(0x09; byte 1\)](#).

6.3.4 Slider

The **IQS263** can be used to do 8-bit coordinate calculations to implement a slider or a scroll wheel. The wheel requires all 3 touch channels, where the slider can be selected as a 2 (channel 1 & 2 required) or 3 channel slider. By default, no calculations are done. To enable a wheel or slider, set the “Slider” bits in the [ProxSettings1 register \(0x09; byte 1\)](#).



When using the wheel setting, Deltas are not available in register 0x06.

6.3.5 Count Filter

The count filter is implemented to provide better stability of Counts (CS) in electrically noisy environments.

The filter also enforces a longer minimum sample time for detecting proximity events on CH0, which will result in a slower response rate when the device enters low power modes. The filter can be disabled.

The count filter is implemented on all channels, to aid in the slider coordinate calculations, but touch events are (by default) determined on unfiltered count values.

The count filter can be disabled, or the speed (amount of filtering) adjusted by setting the “CF” bits in the [ProxSettings1 register \(0x09; byte 1\)](#).

6.4 ProxSettings2

6.4.1 Output Pin

The **IQS263** when operating in Self Capacitive mode has an output/input (PO) pin available (pin 10). As output (active low), it can be set to trigger on proximity, touch (on channel 1) or movement events. As input, it can be used as a synchronization pin to be used as a ZC (zero cross input) for AC applications. To switch between input and output set the “OUT” bits in the [ProxSettings2 register \(0x09; byte 2\)](#). When used as an input pin, the **IQS263** will monitor pin 10, and wait for a change in state (either high to low or low to high), before sensing is initiated. This will happen before each cycle of scanning all the keys.

6.4.2 Movement

The **IQS263** can implement a movement filter on CH0 or CH3. Movement detection will clear/restart the filter halt timer. Movement will be sensed in both directions. By monitoring movement (of the count values), the host controller can distinguish

between user activation and stuck conditions.

The host could choose to implement movement on CH3 or CH0, by setting the “Movement” bits in the [ProxSettings2 register \(0x09; byte 2\)](#).

6.4.3 Wake 2 Directions

The **IQS263** has the ability to wake from low power in both directions of count movement (of the proximity threshold). This could be used to sense release events from low power mode. To enable sensing in both directions, set the “Wake

Release” bit in the [ProxSettings2 register \(0x09; byte 2\)](#).

6.4.4 Wheel/Slider Filter

If the **IQS263** implements a wheel or slider, the coordinate filter can be disabled for faster output (if the layout and environment allows stable output). To disable the coordinate filter set the “Wheel Filter” bit in the [ProxSettings2 register \(0x09; byte 2\)](#).

6.4.5 Force Sleep

MCU can command a sleep during any situation. This sleep can be cancelled by the MCU, or will automatically clear when the LP channels counts differs more than the proximity threshold from the LTA (in any direction if [Wake 2 Directions](#) is enabled). To force the **IQS263** into low power mode set the “Force Sleep” bit in the [ProxSettings2 register \(0x09; byte 2\)](#).

6.4.6 Sleep Halt

The **IQS263** can go back into low power mode rather than reseed or re-tune (ATI) when a stuck condition or prolonged event is present. A low power time greater than zero need to be specified for this setting. To set up the sleep on halt time out feature set the “Sleep Halt” bit in the [ProxSettings2 register \(0x09; byte 2\)](#).

6.5 ProxSettings3

6.5.1 Touch Debounce

The **IQS263** can set the touch output on 4 samples where the delta exceeds the touch



threshold (default 2 samples). A lower debounce will speed up the response rate, especially for applications using the filtered counts for touch output. To set the touch debounce to 4 set the “Touch Debounce” bit in the [ProxSettings3 register \(0x09; byte 3\)](#).

6.5.2 CS cap

The **IQS263** has the option to select a smaller internal sample capacitor (CS cap). If the smaller capacitor is chosen, there will be a drop in counts (as less charge is required to reach the trip level). This is suitable for applications that require low base values. To select the small sample capacitor set the “CS Cap” bit in the [ProxSettings3 register \(0x09; byte 3\)](#).

6.5.3 Projected Bias

The **IQS263** has the option to change the bias current of the transmitter during projected sensing mode. A larger bias current is required when using larger electrodes, but will also increase the IC power consumption. The bias current is default on 10µA, and can be changed to 20µA. To select 20 µA set the “Proj Bias” bit in the [ProxSettings3 register \(0x09; byte 3\)](#).

6.5.4 Float CX

During the charge transfer process, the channels (CX electrodes for Self or Rx electrodes for projected) that are not being processed during the current conversion are effectively grounded to decrease the effects of noise-coupling between the sense electrodes. Grounding these traces is useful in applications with long tracks between IC and sense electrode.

There is the option to float the CX (or Rx) lines in between charging. This is particularly useful for applications with self-capacitive wheels/sliders with thick overlays, where more sensitivity is required, or in application that need to avoid false triggers from water on the overlays. To float channels set the “Float Cx” bit in the [ProxSettings3 register \(0x09; byte 3\)](#).

6.5.5 Auto Threshold Algorithm (ATA)

The **IQS263** offers an additional method of touch threshold equating. For application with a variety of expected environmental working conditions and variations in power supply, such as battery operated devices that must operate on chargers as well, the ATA will adapt the Touch threshold not just with the LTA, but also the ATI parameters. To enable ATA set the “ATA” bit in the [ProxSettings3 register \(0x09; byte 3\)](#).

6.5.6 Turbo Mode

The **IQS263** device by default performs conversions (charge transfers or sensing) as fast as processing and communication allows. Disabling Turbo Mode will yield in a fixed sampling period ($t_{\text{Sample}} = 40/80\text{Hz}$) that will increase the effectiveness of the count filter, but will reduce response rate. To disable turbo mode set the “Turbo Mode” bit in the [ProxSettings3 register \(0x09; byte 3\)](#).

6.5.7 Filtered Touches

The **IQS263** offers applications that are sensitive to touch detection and releasing upon soft touch events the option to trigger touch outputs on filtered count values. This improves stability, but could reduce response rate. To enable the filtered touches feature set the “Filtered Touches” bit in the [ProxSettings3 register \(0x09; byte 3\)](#).

6.5.8 Charge Transfer Frequency

The **IQS263** can reduce the charge transfer frequency for applications that require extra sensitivity (for example very thick overlays). The charge transfer frequency can be halved (for both Self and Projected operation) by setting the “Xfer” bit in the [ProxSettings3 register \(0x09; byte 3\)](#).

6.6 Active Channels

The **IQS263** can be configured to have up to 3 active touch channels (CH1-CH3) with one additional proximity channel (CH0). By default CH0 is a distributed proximity



channel, comprised of charging all the channels together in one timeslot.

6.7 Proximity Threshold

A proximity threshold for channel 0 can be selected for the application, to obtain the desired proximity trigger level. The proximity threshold is selectable between 1 (most sensitive) and 255 (least sensitive) counts. These threshold values (i.e. 1-255) are specified in Counts (CS) in the [Thresholds register \(0x0A; byte 0\)](#). The default proximity threshold is four counts.

6.8 Touch Thresholds

A touch threshold for each channel can be selected by the designer to obtain the desired touch sensitivity and is selectable between 1/256 (most sensitive) to 255/256 (least sensitive). The touch threshold is calculated as a fraction of the Long-Term Average (LTA) given by,

$$T_{THR} = x/256 \times LTA$$

With lower target values (therefore lower LTA's) the touch threshold will be lower and vice versa.

Individual touch thresholds can be set for each channel, by writing to the [Thresholds register \(0x0A; byte 1\)](#) for channel 1, byte 2 for channel 2 and byte 3 for channel 3. The default touch threshold is 16/256 times the LTA.

Note: There is also the option to select a detection constant (with [ATA](#)) that scales with ATI parameters, for applications sensitive to process and environmental distribution to ensure optimal performance of the **IQS263**. This constant is also set in the [Thresholds register \(0x0A; byte 1\)](#) for channel 1, byte 2 for channel 2 and byte 3 for channel 3. The detection threshold is internally calculated with the ATI parameters, according to the environment.

The designer only needs to increase or decrease the constant during prototyping for each channel until desired touch strength is detected.

6.9 Adjustable Report Rate

The **IQS263** can adjust its report rate from to 80Hz ([4Mhz oscillator](#)) to 40Hz (2MHz). The **IQS263** can also disable [turbo mode](#), which will yield a fixed sampling period, to optimize the count filter operation.

6.10 Gestures

The **IQS263** implements a tap gesture on the slider or scroll wheel. Left and right flick gestures are only implemented on the slider (no double tap). For flick events, one of the [slider options](#) should be active.

6.10.1 Tap

The **IQS263** implements an adjustable TAP timer for configurable tap recognition. The timer is started once a touch event is recognised. A tap event will be registered if the touch event is released (cleared) before the timer reaches the adjustable tap time. The tap time can be adjusted in the [Gesture Timer register \(0x0C, byte 0\)](#).

6.10.2 Flicks

The **IQS263** implements an adjustable Flick recognition on the slider setups. The user has the option to specify the flick threshold in the [Gesture Timer register \(0x0C, byte 1\)](#) to set the amount that the coordinates must be adjusted by the user before the flick event is set. There is also the option to adjust the time in which the coordinate must move by setting the flick timer in the [Gesture Timer register \(0x0C, byte 2\)](#).

6.11 Halt times

The LTA filter for all channels will halt on proximity or touch events. The halt time is specified through the memory map in terms of number of samples (sampling of all active channels) by specifying a value in the [Thresholds register \(0x0A; byte 6\)](#). The halt time is calculated as this value times



50. Writing FF will result in “Always Halt” while 00 will be seen as never halt. The default value is 20, therefore the halt time will be

$$t_{HALT} = 20 \times 50$$

which is 1000 samples. The halt timer clears on any new touch, proximity or slider activity.

6.12 Power Modes

6.12.1 LP Modes

The IQS263 IC has a configurable low power mode, specifically designed to reduce current consumption for low power and battery applications. When designing for low power operation, the V_{REG} capacitors should ensure that V_{REG} does not drop more than 50mV during low power operations.

The power modes are implemented around the occurrence of a charge cycle every t_{LP} seconds. The value of t_{LP} is determined by the custom (LP_{value}) value between 1 and 255, multiplied by 16ms. The LP_{value} can be specified by writing to the [Timings register \(0x0B; byte 0\)](#). It is suggested not to exceed $LP_{value} = 32$ (512ms) as the reduction in current consumption is negligible, response time becomes notable slower, and special attention needs to be paid to V_{REG} capacitor design to ensure stable operation. Only CH0 is charged during LP, and is forced active (CH0 cannot be disabled). The other active channels will be periodically charged to keep their LTA filter values up to date.

Lower sampling times yield significantly lower power consumption (but also decreases the response time of the first event).

NOTE: While in any power mode the device will zoom to Boost Power (BP)

mode whenever the condition $(CS - LTA)^1 > PROX_TH$ or $TOUCH_TH$ holds, indicating a possible proximity or touch event. This improves the response time. The device will remain in BP mode for 4 seconds and then return to the selected power mode. The Zoom function allows reliable detection of events with counts being produced at the BP rate. The LP charge cycle timing is illustrated in **Figure 6.1**.

¹ CS-LTA in Projected mode. LTA-CS in Self capacitive sensing mode.

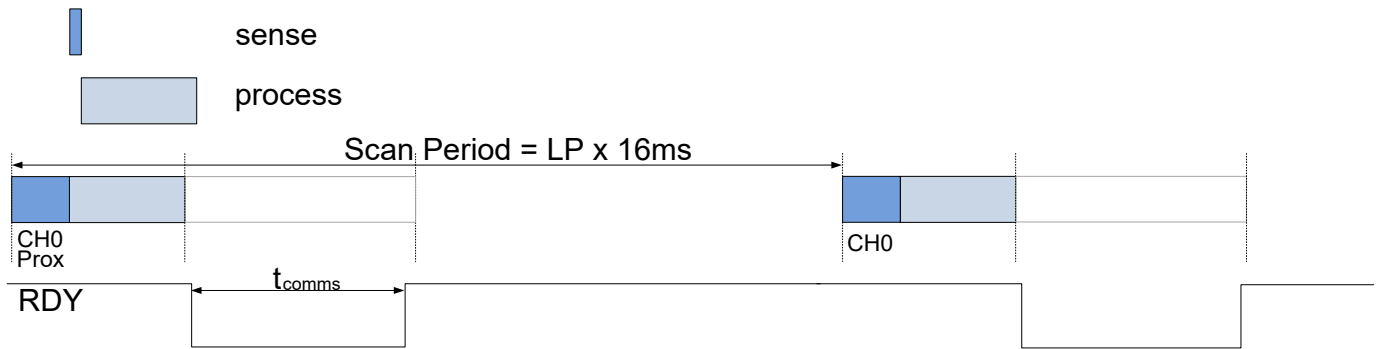

Figure 6.1 IQS263 Charge Cycle Timing in Low Power Mode.

Table 6.1 Typical Timings

Typical timings of IQS263 in Low Power		
t_{sense}	1.1	ms
$t_{process}$	1.9	ms
t_{comms}	Application specific	ms
Scan Period	Should not exceed 512ms	



6.13 Base Value

The **IQS263** has the option to change the base value of the proximity channel (CH0) and the touch channels (CH1 to CH3) during the Full ATI algorithm. This provides the user with another option to select the sensitivity of the **IQS263** without changes in the hardware (CRX/CTX sizes and routing, etc).

The base values are set by writing to the [Multipliers register \(0x07; byte 4\)](#). There are 16 different options to choose from. To choose a custom base value, select [partial ATI](#).

The base value influences the overall sensitivity of the channel and establishes a base count from where the ATI algorithm starts executing. A lower base value will typically result in a higher sensitivity of the respective channel, as lower multipliers will be selected, and more compensation would be required.

6.14 Target Value

The default target value of the **IQS263** is 384 counts for the touch channels and 512 counts for the proximity channel.

The target values are calculated by multiplying the value in the [Timings & Targets register \(0x0B; byte 1\)](#) for channel

1 to channel 3 and byte 2 for channel 0 by 8.

Example: CH0 target = Register Value x 8
= 64(default) x 8 = 512.

6.15 Additional Features

6.15.1 Force Halt

The Force Halt bit can be set to halt all current LTA values and prevent them from being adjusted towards the CS values.

Setting this bit overrides all filter halt settings and prevents the device from performing re-ATI events in cases where the CS values persist outside the ATI boundaries for extended periods of time. Reseed will also not be possible.

6.15.2 Halt Timeout Reseed Block

After the halt timer times out upon an event, the **IQS263** will reseed all channels and possibly redo ATI if any counts are outside the allowed band. The user has the option to block this reseed on any of the touch channels (not CH0) allowing that channel(s) to keep its output state and effectively have an always halt condition. Note that other channels could drift outside the ATI band, but no ATI will take place if a channel is halted in this way. To set any combination of channels up for this state, select the corresponding bits in the [Halt Timeout Reseed Block register \(0x0A, byte 5\)](#).

7 Sliders/Wheel Coordinate to Position Mapping

The coordinate mapping from user finger positions given in this section is applicable to both Self- and Projected Capacitive sensing, even though examples of both will not be shown.

7.1 Two (2) Channel Slider

The 2 channel slider is recommend for application requiring only the relative coordinate and/or the flick event. The 2 channel slider is not optimal for absolute coordinates.

Figure 7.1 shows the channel numbers and finger positions for the main definable positions where channels overlap on a 2 channel slider.

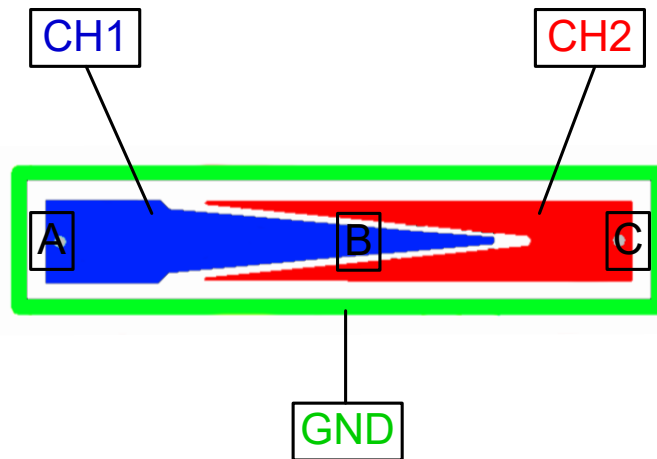

Figure 7.1 Finger positions for coordinate mapping shown on a 2 channel slider.

Table 7.1 shows the coordinate that the IQS263 will report for the finger positions shown in Figure 7.1.

Table 7.1 2CH slider coordinate mapping.

Positions	Coordinates
A	0
A to B	1 - 127
B	128
B to C	129 – 254
C	255

7.2 Three (3) Channel Slider

Figure 7.2 shows the channel numbers and finger positions for the main definable positions where channels overlap on a 3 channel slider.

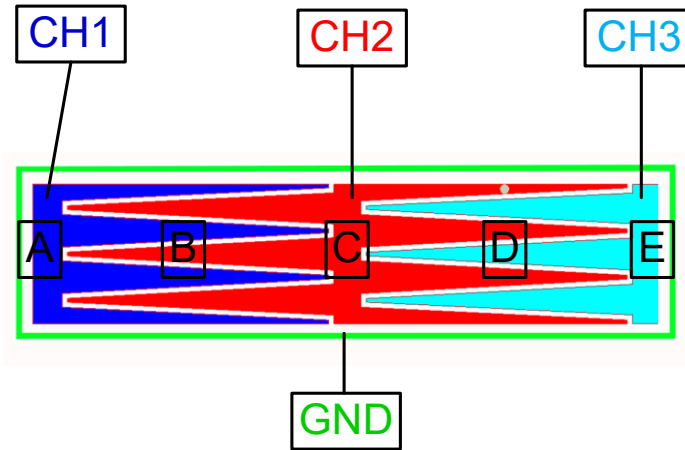

Figure 7.2 Finger positions for coordinate mapping shown on a 3 channel slider.

Table 7.2 shows the coordinate that the IQS263 will report for the finger positions shown in Figure 7.3.

Table 7.2 3CH slider coordinate mapping.

Positions	Coordinates
A	0
A to B	1 – 63
B	64
B to C	65 - 127
C	128
C to D	129 – 191
D	192
D to E	193 – 254
E	255

7.3 Wheel / Wrap around Slider

Figure 7.3 shows the channel numbers and finger positions for the main definable positions where channels overlap on a wraparound slider and wheel.

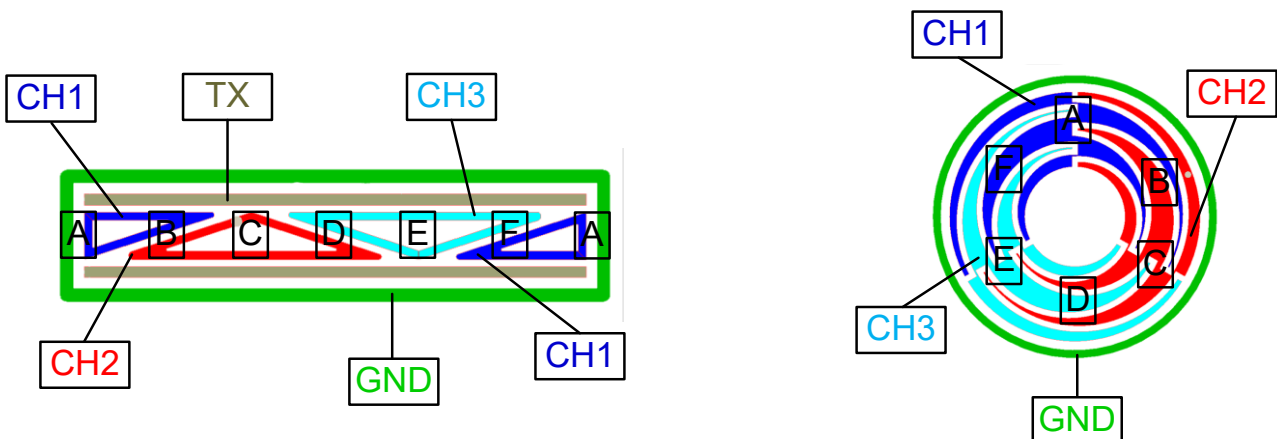

Figure 7.3 Finger positions for coordinate mapping shown on a wheel and wrap around slider.



Table 7.3 shows the coordinate that the **IQS263** will report for the finger positions shown in Figure 7.3.

Table 7.3 Wrap around slider or wheel coordinate mapping.

Positions	Coordinates
A	0
A to B	1 - 31
B	32
B to C	33 – 63
C	64
C to D	65 – 96
D	96
D to E	97 – 127
E	128
E to F	129 – 191
F	192
F to A	193 – 255

The coordinates for the wheel or wrap around slider increase by 32 in each section from A to E as shown in Table 7.3, where after it increases by 64 from E to F and F to A. This is designed to allow faster relative coordinate on the top end of the wrap around slider.

If the master would like the coordinates from E to F back to A to change at the same rate as A to E, the MCU can apply the following calculation:

- If Coordinate < 128 then the coordinate stays unchanged
- When the coordinate > 128 (area between E and A) the following calculation needs to be made:

$$\text{Coordinate} = (\text{Coordinate} - 128)/2 + 128.$$

When applying this calculation, the coordinates will map as shown in Table 7.4.

Table 7.4 Wrap around slider or wheel coordinate mapping with MCU adjustment.

Positions	Coordinates
A	0
A to B	1 - 31
B	32
B to C	33 – 63
C	64
C to D	65 – 96
D	96
D to E	97 – 127
E	128
E to F	129 – 159
F	160
F to A	161 – 192



8 ProxSense® Module

The **IQS263** contains a ProxSense® module that uses patented technology to provide detection of proximity and touch conditions on numerous sensing lines.

The ProxSense® module is a combination of hardware and software, based on the principles of charge transfer measurements.

8.1 Charge Transfer Concept

On ProxSense® devices like the **IQS263**, capacitance measurements are taken with a charge transfer process that is periodically initiated.

For projected capacitive sensing, the device measures the capacitance between 2 electrodes referred to as the transmitter (CTX) and receiver (CRX).

The measuring process is referred to as a charge transfer cycle and consists of the following:

- Discharging of an internal sampling capacitor (C_s) and the electrode capacitors (mutual: CTX & CRX) on a channel.
- charging of CTX's connected to the channel
- and then a series of charge transfers from the CRX's to the internal sampling capacitors (C_s), until the trip voltage is reached.

The number of charge transfers required to reach the trip voltage on a channel is referred to as the Current Samples (**CS**) or Count value (Counts).

The device continuously repeats charge transfers on the sense electrodes connected to the CRX pins. For each channel a Long Term Average (**LTA**) is calculated (12 bit unsigned integer values). The count (CS) values (12 bit unsigned

integer values) are processed and compared to the LTA to detect Touch and Proximity events.

Please note: Attaching scope probes to the CTX/CRX pins will influence the capacitance of the sense electrodes and therefore the related CS values of those channels. This will have an instant effect on the CS measurements.

8.2 Rate of Charge Cycles

The **IQS263** samples all its active channels (up to 3 + channel 0 for proximity) in 4 timeslots. The charge sequence (as measured on the receive electrodes) is shown in Figure 8.1, where CH0, the Proximity channel, charges first, followed by all other active channels. There is only a communication window after all active channels have been charged.

The charging of CH0 comprises the simultaneous charging of the three receive electrodes (CRX0, CRX1 and CRX2) in conjunction with the transmit electrode, thus realising a distributed load mutual capacitive sense electrode.

In self-capacitive mode, CH0 is also a distributed channel charging all 3 CX channels together.

8.2.1 Boost Power rate

With the **IQS263** zoomed to Boost Power (BP) mode, the active channels are charged at a fixed sampling period (t_{SAMPLE}) per channel (if Turbo Mode is not enabled). This is done to ensure regular samples for processing of results, and fix timings for the halt times.

It is calculated as each channel having a time $t_{SAMPLE} = \text{charge/conversion time } (t_{SENSE}) + \text{computation time } (t_{PROCESS})$ of approximately $t_{SAMPLE} = 1.6\text{ms}$. Thus the time between consecutive samples on a specific channel (Scan Period) will depend on the number of enabled channels and the length of communication between the



IQS263 and the host MCU. Communication will always happen after processing of channel 0. Due to processing and charging happening in parallel, the first active channel (default channel 1) will charge while channel 0 is processed. Therefore,

communication windows will always be after the first active channel has completed conversions. The **IQS263** does check for MCU requesting a communication window after ever channel completed charging.

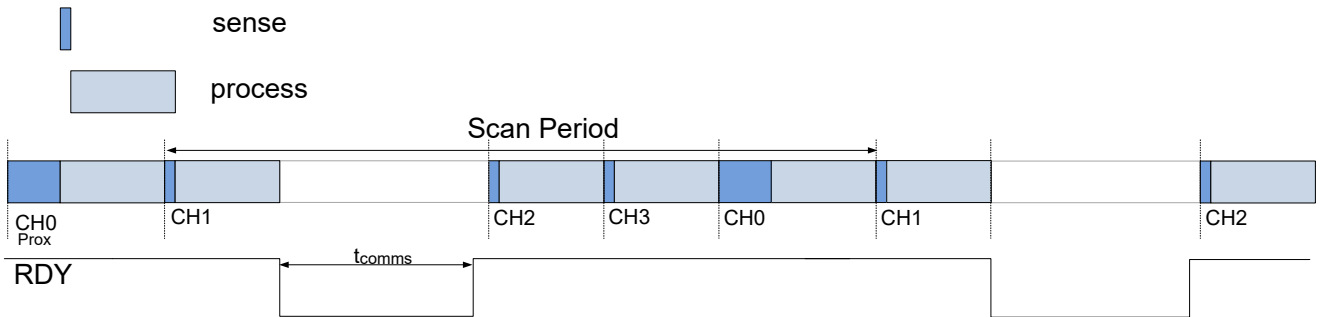

Figure 8.1 IQS263 Charge Sequence timing diagram in Boost Power mode.

Table 8.1 Typical Timings

Typical timings of IQS263		
t_{sense}	840	μs
$t_{process}$	3.9	ms
t_{comms}	2	ms
Scan Period ¹	22	ms

Typical timings of the charge sequence shown above are listed in Table 8.1. These timings are only as reference, as they will differ with each application, depending on the setup of the **IQS263**. For example, the sense (or charge time) is affected by the target counts and charge transfer frequency, while process time is dependent on the turbo mode activation, ATI checking for counts within the allowed band, filter settings and slider calculations. Communication time is affected by the MCU clock speed and the amount of data read (as well as the sequence thereof). Communication time and the number of active channels will influence the Scan Period.

¹ All channels active and status byte read during communication window. Self capacitive mode, all other settings default.



8.2.2 Low Power rate

A wide range of low current consumption charging modes is available on the **IQS263**.

In any Low Power (LP) mode, there will be an applicable low power time (t_{LP}).

With the detection of an undebounced proximity event the IC will zoom to BP mode, allowing a very fast reaction time for further possible touch events.

During any LP mode, only channel 0 is charged every t_{LP} . The LP charge timing is illustrated in **Figure 6.1**.

If a low power rate is selected and charging is not in the zoomed state (BP mode), the low power active bit (Register 0x01) will be set.

Please refer to **Section 6.12**.

8.3 Touch report Rate

During Boost Power (BP) mode, the touch report rate of the **IQS263** device depends on the charge transfer frequency, the number of channels enabled and the length of communications performed by the host MCU or master device.

Several factors may influence the touch report rate:

- **Enabled channels:** Disabling channels that are not used will not only increase the touch report rate, but will also reduce the device's current consumption.
- **Turbo Mode:** See Section 6.5.6
- **Target Values:** Lower target values requires shorter charge transfer times (t_{SENSE}), thus reducing the SCAN PERIOD and increasing the touch report rate.
- **Charge Transfer Speed:** Increasing the charge transfer frequency will

reduce the conversion time (t_{SENSE}) and increase the touch report rate.

- **ACF:** Disabling the AC filter and wheel/slider position calculations will reduce the processing time ($t_{PROCESS}$) and yield a faster report rate.

8.4 Long Term Average

The Long-term Average (LTA) filter can be seen as the baseline or reference value. The LTA is calculated to continuously adapt to any environmental drift. The LTA filter is calculated from the CS value for each channel. The LTA filter allows the device to adapt to environmental (slow moving) changes/drift. Actuation (Touch or Prox) decisions are made by comparing the CS value with the LTA reference value.

8.5 Determine Touch or Prox

An event is determined by comparing the CS value with the LTA. Since the CS reacts differently when comparing the self- with the mutual capacitance technology, the user should consider only the conditions for the technology used.

An event is recorded if:

- Self: $CS < LTA - \text{Threshold}$
- Projected: $CS > LTA + \text{Threshold}$

Threshold can be either a Proximity or Touch threshold, depending on the current channel being processed.

Note that a proximity condition will be forced enabled if there is a touch condition on any channel.

Please refer to **Section 6.7** and **6.8** for proximity and touch threshold selections.



8.6 ATI

The **Automatic Tuning Implementation (ATI)** is a sophisticated technology implemented on the new ProxSense® series devices. It allows for optimal performance of the devices for a wide range of sense electrode capacitances, without modification or addition of external components.

The ATI allows the tuning of two parameters, an ATI Multiplier and an ATI Compensation, to adjust the Count values for an attached sense electrode.

ATI allows the designer to optimize a specific design by adjusting the sensitivity and stability of each channel through the adjustment of the ATI parameters.

The **IQS263** has a full ATI function. The full-ATI function is default enabled, but can be disabled by setting the **ATI_OFF** bit, or changed to partial or alternative ATI by setting the **ATI_Partial** and **ATI_ALT**.

The **ATI_Busy** bit will be set while an ATI event is busy.

For more information regarding the ATI algorithm, please contact Azoteq at: ProxSenseSupport@azoteq.com

8.6.1 ATI Sensitivity

On the **IQS263** device, the user can specify the **BASE** value (**Section 6.13**) and the **TARGET** value (**Section 6.14**) for the proximity channel (CH0) and touch channels (CH1-CH3).

A rough estimation of sensitivity can be calculated as:

$$\text{Sensitivity} \propto \frac{\text{TARGET}}{\text{BASE}}$$

As can be seen from this equation, the sensitivity can be increased by either increasing the Target value or decreasing the Base value. It should, however, be

noted that a higher sensitivity will yield a higher noise susceptibility.

8.6.2 ATI Target

The target value is reached by adjusting the **COMPENSATION** bits for each channel (ATI target limited to 2048 counts).

The target value is written into the respective channel's **TARGET** registers. The value written into these registers multiplied by 8 will yield the new target value. (Please refer to **Section 6.14**)

8.6.3 ATI Base (Multiplier)

The following parameters will influence the base value:

- **C_s_SIZE¹**: Size of sampling capacitor.
- **PROJ_BIAS** bits: Adjusts the biasing of some analogue parameters in the mutual capacitive operated IC. (Only applicable in mutual capacitance mode.)
- **Charge Transfer Frequency**
- **MULTIPLIER** bits.

The base value used for the ATI function can be implemented in 2 ways:

1. **ATI_PARTIAL = 0**. ATI automatically adjusts **MULTIPLIER** bits to reach a selected base value². Please refer to **Section 6.13** for available base values.
2. **ATI_PARTIAL = 1**. The designer can specify the multiplier settings. These settings will give a custom base value from where the compensation bits will be automatically implemented to reach the required target value. The base value is

¹ Changing **C_s_SIZE** if **ATI_OFF = 0** will change **CS**

² ATI function will use user selected **C_s_SIZE** and **PROJ_BIAS** (if applicable) and will only adjust the **MULTIPLIER** bits to reach the base values.



determined by two sets of multiplier bits. Sensitivity Multipliers which will also scale the compensation to normalise the sensitivity and Compensation Multipliers to adjust the gain.

8.6.4 Re-ATI

An automatic re-ATI event will occur if the counts are outside its re-ATI limits. The re-ATI limit or ATI boundary is calculated as the target value divided by 8. For example:

- Target = 512, Re-ATI will occur if CS is outside 512 ± 64 .

A re-ATI event can also be issued by the host MCU by setting the REDO_ATI bit. The REDO_ATI bit will clear automatically after the ATI event was started.

Note: Re-ATI will automatically clear all proximity, touch and halt status bits.

8.6.5 ATI ERROR

The ATI error bit (read only) indicates to the user that the ATI targets where not reached. Adjustments of the base values or ATI BANDs are required.

9 Communication

The IQS263 device interfaces to a master controller via a 3-wire (SDA, SCL and RDY) serial interface bus that is I²C™ compatible, with a maximum communication speed of 400kbit/s.

9.1 Control Byte

The Control byte indicates the 7-bit device address (44H default) and the Read/Write indicator bit. The structure of the control byte is shown in Figure 9.1.

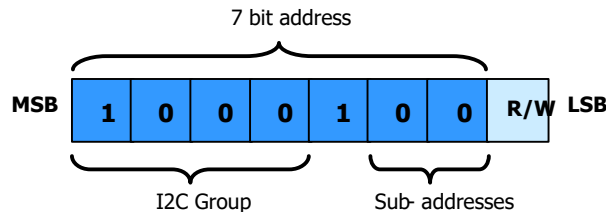

Figure 9.1 IQS263 Control Byte.

The I²C device has a 7 bit Slave Address (default 0x44H) in the control byte as shown in Figure 9.1. To confirm the address, the software compares the received address with the device address. Sub-address values can be set by OTP programming options.

9.2 I²C Read

To read from the device a *current address read* can be performed. This assumes that the address-command is already setup as desired.

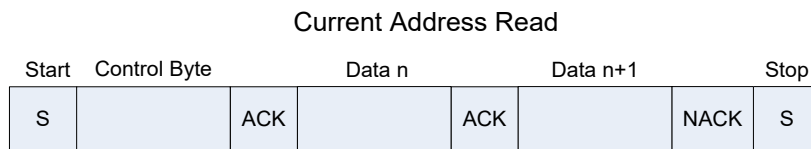

Figure 9.2 Current Address Read.

If the address-command must first be specified, then a *random read* must be performed. In this case a WRITE is initially performed to setup the address-command, and then a repeated start is used to initiate the READ section.



Figure 9.3 Random Read.

9.3 I²C Write

To write settings to the device a *Data Write* is performed. Here the Address-Command is always required, followed by the relevant data bytes to write to the device.

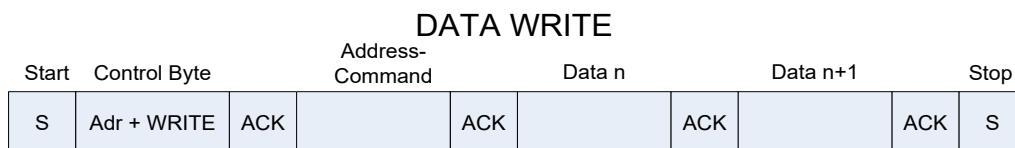

Figure 9.4 I²C Write.



9.4 End of Communication Session / Window

Similar to other Azoteq I²C devices, to end the I²C communication session, a STOP command is given. When sending numerous read and write commands in one communication cycle, a repeated start command must be used to stack them together (since a STOP will jump out of the communication window, which is not desired).

The STOP will then end the communication, and the **IQS263** will return to process a new set of data. Once this is obtained, the communication window will again become available (RDY set LOW).

9.5 I²C Sub-address

The **IQS263** has four available sub addresses, 44H (default) to 47H, which allows up to four devices on a single I²C bus.

9.5.1 Internal sub-address selection

Selecting the sub-address via OTP bits allows the user 4 different options:

Table 9.1 I²C sub-address selection

FG25	FG26	Device Address
0	0	0x44
0	1	0x45
1	0	0x46
1	1	0x47

9.6 RDY Hand-Shake Routine

The master or host MCU has the capability to request a communication window at any time, by pulling the RDY line low. The communication window will open directly following the current conversion cycle. For more details please refer to the communication interface guide.

9.7 I²C Specific Commands

9.7.1 Show Reset

After start-up, and after every reset event, the “Show Reset” flag will be set in the [System Flags register \(0x01H; byte 0\)](#).

The “Show Reset” bit can be read to determine whether a reset has occurred on the device (it is recommended to be continuously monitored). This bit will be set '1' after a reset.

The SHOW_RESET bit will be cleared (set to '0') by writing a '0' into the “Show Reset”

bit. A reset will typically take place if a timeout during communication occurs.

9.7.2 I2C Timeout

If no communication is initiated from the master/host MCU within the first t_{COMMS} ($t_{COMMS} = 5.12ms$ default) of the RDY line indicating that data is available (i.e. RDY = low), the device will resume with the next cycle of charge transfers and the data from the previous conversions will be lost. The timeout time is adjustable in steps of 1.28ms in the [Thresholds register \(0x0A; byte 7\)](#). There is also a timeout (t_{I2C}) that cannot be disabled, for when communication has started but not been completed, for example when the bus is being held by another device. $t_{I2C} = 150ms$.

9.8 I²C I/O Characteristics

The **IQS263** requires the input voltages given in **Table 9.2**, for detecting high (“1”) and low (“0”) input conditions on the I²C communication lines (SDA, SCL and RDY).

Table 9.2 IQS263 I²C Input voltage

	Input Voltage (V)
V _{in} LOW	0.3*VDDHI
V _{in} HIGH	0.7*VDDHI

Table 9.3 provides the output voltage levels of the **IQS263** device during I²C communication.

Table 9.3 IQS263 I²C Output voltage

	Output Voltage (V)
V _{out} LOW	GND +0.2 (max.)
V _{out} HIGH	VDDHI – 0.2 (min.)



10 Communication Command/Address Structure

10.1 Registers & Memory map

Table 10.1 IQS263 Registers

Address	Description	Access	Section
0x00H	Device Information	R	10.2.1
0x01H	System Flags	R/W	10.2.2
0x02H	Coordinates	R	10.2.3
0x03H	Touch Bytes	R	10.2.4
0x04H	Counts	R	10.2.5
0x05H	LTA	R	10.2.6
0x06H	Deltas	R	10.2.7
0x07H	Multipliers	R/W	10.2.8
0x08H	Compensation	R/W	10.2.9
0x09H	ProxSettings	R/W	10.2.10
0x0AH	Thresholds	R/W	10.2.11
0x0BH	Timings & Targets	R/W	10.2.12
0x0CH	Gesture Timers	R/W	10.2.13
0x0DH	Active Channels	R/W	10.2.14

10.2 Registers Descriptions

10.2.1 Device Information 0x00H

Information regarding the device type and version is recorded here. Any other information specific to the device version can be stored here. Each Azoteq ROM has a unique Product- and Version number.

		Product Number (PROD_NUM)							
Access	Bit	7	6	5	4	3	2	1	0
R	Value	0x3C							



		Version Number (VERSION_NUM)							
Access	Bit	7	6	5	4	3	2	1	0
R	Value	0x00							

10.2.2 System Flags 0x01H

		System Flags (SYSFLAGS0)							
Access	Bit	7	6	5	4	3	2	1	0
R/W	Name	Show Reset	Move ment	ATI Error	Proj Mode	Filter Halt	ATI Busy	Ind Halt	LP Active

		Events							
Access	Bit	7	6	5	4	3	2	1	0
R	Name	Flick Right	Flick Left	Tap	Move ment	ATI Event	Slide Event	Touch Event	Prox Event

10.2.3 Wheel Coordinates 0x02H

		Wheel 1 Low							
Access	Bit	7	6	5	4	3	2	1	0
R	Name	Wheel 1 Coordinate Low byte first							

		Relative Coordinate Low							
Access	Bit	7	6	5	4	3	2	1	0
R	Name	Relative Coordinate Low byte first							

		Relative Coordinate High							
Access	Bit	7	6	5	4	3	2	1	0
R	Name	Relative coordinate High byte							



10.2.4 Touch Bytes 0x03H

		Touch Byte 0							
Access	Bit	7	6	5	4	3	2	1	0
R	Name					CH3	CH2	CH1	CH0 ¹

		Halt Byte 1							
Access	Bit	7	6	5	4	3	2	1	0
R	Name					CH3	CH2	CH1	CH0 ²

Bit 0 of the first byte (CH0) will indicate proximity events; the rest of the bits indicate touches as shown. The second byte shows the halt status bits.

10.2.5 Counts 0x04H

This register has 10 bytes to store the count values of the low power channel and then CH0 up to CH3 the low byte will always read out first, followed by the high byte, before the moving to the next channel.

		Low Power Channel Low							
Access	Bit	7	6	5	4	3	2	1	0
R	Name	Low Power Channel CS (Counts) Low byte first							
Byte 0									

		CH 3 Counts High byte							
Access	Bit	7	6	5	4	3	2	1	0
R	Name	Channel 3 Count value (High byte last)							
Byte 9									

10.2.6 LTA 0x05H

This register has 10 bytes to store the LTA values of the low power channel and then CH0 up to CH3 the low byte will always read out first, followed by the high byte, before the moving to the next channel.

¹ CH0 indicates Proximity, not Touch.

² CH0 indicates Proximity, not Touch.



		Low Power Channel LTA Low byte							
Access	Bit	7	6	5	4	3	2	1	0
R	Name	Low Power Channel LTA value (Low byte first)							
Byte 0									

		CH 3 LTA High byte							
Access	Bit	7	6	5	4	3	2	1	0
R	Name	Channel 3, LTA value (High byte last)							
Byte 9									

10.2.7 Deltas 0x06H

This register has 8 bytes to store the Delta (the difference between Count and LTA) values of CH0 up to CH3. The low byte will always read out first, followed by the high byte, before the moving to the next channel. Deltas are not available when using the wheel setting.

		Delta Counts for CH0 Low							
Access	Bit	7	6	5	4	3	2	1	0
R	Name	Delta for CH0 – Low Byte first							
Byte 0									

		Delta Counts for CH3 High							
Access	Bit	7	6	5	4	3	2	1	0
R	Name	Delta for CH3 – High Byte last							
Byte 7									

10.2.8 Multipliers 0x07H

		CH0 Multipliers							
Access	Bit	7	6	5	4	3	2	1	0
R	Name	Sensitivity Multipliers				Comp Multipliers			



Byte 0									
	CH1 Multipliers								
Access	Bit	7	6	5	4	3	2	1	0
R	Name	Sensitivity Multipliers			Comp Multipliers				
Byte 1									
	CH2 Multipliers								
Access	Bit	7	6	5	4	3	2	1	0
R	Name	Sensitivity Multipliers			Comp Multipliers				
Byte 2									
	CH3 Multipliers								
Access	Bit	7	6	5	4	3	2	1	0
R	Name	Sensitivity Multipliers			Comp Multipliers				
Byte 3									

	Base Value								
Access	Bit	7	6	5	4	3	2	1	0
R	Name	Channels 1-3				Channel 0			
Byte 4	Default	0x44							

Base Value Options:

0000	- 74	1000	- 202
0001	- 90	1001	- 218
0010	- 106	1010	- 234
0011	- 122	1011	- 250
0100	- 138 (default)	1100	- 266
0101	- 154	1101	- 282
0110	- 170	1110	- 298



0111 - 186

1111 - 314

10.2.9 Compensation 0x08H

		CH0 Compensation value							
Access	Bit	7	6	5	4	3	2	1	0
R/W	Name	Channel 0 Compensation							
Byte 0									

		CH 3 Compensation Value							
Access	Bit	7	6	5	4	3	2	1	0
R/W	Name	Last active channel Compensation							
Byte 3									

10.2.10 ProxSettings 0x09H

		ProxSettings0							
Access	Bit	7	6	5	4	3	2	1	0
R/W	Name	ATI OFF	ATI Partial	ATI Band	Redo ATI	Reseed	Stream ATI	4MHz	Force Halt
Byte 0	Default	0x00H							

Bit 7: 0 = ATI Enable
1 = ATI Disabled

Bit 6: 0 = Full ATI
1 = Partial ATI

Bit 5: 0 = 1/8 * LTA
1 = 1/4 * LTA

Bit 4: 0 = No Action
1 = Redo ATI

Bit 3: 0 = No Action
1 = Send Reseed

Bit 2: 0 = No communication widows during ATI routine
1 = Communication windows after each charge cycle regardless of ATI busy.



Bit 1: 0 = 2MHz Oscillator
1 = 4MHz Oscillator

Bit 0: 0 = No Action
1 = Forcing all LTAs to stop calculating

		ProxSettings1							
Access	Bit	7	6	5	4	3	2	1	0
R/W	Name	WDT OFF	Event Mode	LTA Beta		Slider		CF	
Byte 1	Default	0x11H							

Bit 7: 0 = WDT Enable
1 = WDT Disabled

Bit 6: 0 = Streaming Mode
1 = Event Mode

Bit 5:4: 00 = 2⁹
01 = 2⁸ (default)
10 = 2⁷
11 = 2⁶ (fastest following)

Bit 3:2: 00 = Slider Disabled
01 = 2CH Slider
10 = Wheel (Also used for 3CH wrap around slider)
11 = 3CH Slider

Bit 1:0: 00 = Counts Filtering OFF
01 = Beta - 01
10 = Beta - 02
11 = Beta – 03 (largest filter for noise suppression, slowest response)

		ProxSettings2							
Access	Bit	7	6	5	4	3	2	1	0
R/W	Name	Sleep Halt	Force Sleep	Wake Release	Wheel Filter	Movement		OUT	



Byte 2	Default	0x00H
---------------	----------------	-------

- Bit 7:** 0 = Reseed upon Halt timer expiration
1 = Return to LP upon Halt timer expiration
- Bit 6:** 0 = No Action
1 = Send Force Sleep
- Bit 5:** 0 = Wake from LP only in the normal direction (Counts below LTA for Self)
1 = Wake from LP for counts in both direction
- Bit 4:** 0 = Coordinate Filter Enabled
1 = Coordinate Filter Disabled
- Bit 3:2:** 00 = Movement Disabled
01 = Movement on CH0
10 = Movement on CH3
- Bit 1:0:** 00 = Prox
01 = Sync (ZC input)
10 = Touch on CH1
11 = Movement output

		ProxSettings3							
Access	Bit	7	6	5	4	3	2	1	0
R/W	Name	Touch	CS	Proj	Float	ATA	Turbo	Filtered	Xfer
		Debounce	Cap	Bias	Cx		Mode	Touches	
Byte 3	Default	0x00H							

- Bit 7:** 0 = 2 consecutive samples
1 = 4 Sample
- Bit 6:** 0 = Large Internal CS capacitor
1 = Small Internal CS capacitor
- Bit 5:** 0 = 10uA
1 = 20uA
- Bit 4:** 0 = Grounded
1 = Floating
- Bit 3:** 0 = Normal Touch Thresholds
1 = Automatic adjustment of Touch Thresholds
- Bit 2:** 0 = Turbo Mode Enabled



1 = Turbo Mode Disabled

Bit 1: 0 = Touch detection on unfiltered counts

1 = Touch detection on filtered counts

Bit 0: 0 = Fast Charging

1 = Slower Charging

		Event Mask							
Access	Bit	7	6	5	4	3	2	1	0
R/W	Name	Flick Left	Flick Right	Tap	Move ment	ATI	Slide	Touch	Prox
Byte 4	Default	0xFFH							

10.2.11 Thresholds 0x0A

		Proximity Threshold							
Access	Bit	7	6	5	4	3	2	1	0
R/W	Name	Value							
Byte 0	Default	4D							

		Touch Threshold CH1							
Access	Bit	7	6	5	4	3	2	1	0
R/W	Name	1-255							
Byte 1	Default	16D							

		Touch Threshold CH3							
Access	Bit	7	6	5	4	3	2	1	0
R/W	Name	1-255							
Byte 3	Default	16D							

		Movement Threshold							
Access	Bit	7	6	5	4	3	2	1	0
R/W	Name	1-255							



Byte 4	Default	3D							
---------------	----------------	----	--	--	--	--	--	--	--

		Halt timeout Reseed Block							
Access	Bit	7	6	5	4	3	2	1	0
R/W	Name				CH3		CH2		CH1
Byte 5	Default	0							

		Halt Time in Number of Samples							
Access	Bit	7	6	5	4	3	2	1	0
R/W	Name	Value times 50 (FF = Always; 00 = Never)							
Byte 6	Default	20D							

		I2C Timeout							
Access	Bit	7	6	5	4	3	2	1	0
R/W	Name	Value times 1.28ms							
Byte 7	Default	4D							

10.2.12 Timings 0x0BH

		Low Power Time							
Access	Bit	7	6	5	4	3	2	1	0
R/W	Name	Steps of 16ms (Value times 16ms)							
Byte 0	Default	0x00H							

		ATI Target for Touch Channels							
Access	Bit	7	6	5	4	3	2	1	0
R/W	Name	Steps of 8 (Value times 8)							
Byte 1	Default	48D							



		ATI Target for Proximity							
Access	Bit	7	6	5	4	3	2	1	0
R/W	Name	Steps of 8 (Value times 8)							
Byte 2	Default	64D							

10.2.13 Gesture Timers 0x0CH

		Tap Timer							
Access	Bit	7	6	5	4	3	2	1	0
R/W	Name	Tap Timer Limit							
Byte 0	Default	5D							

		Flick Timer							
Access	Bit	7	6	5	4	3	2	1	0
R/W	Name	Flick Timer Limit							
Byte 1	Default	20D							

		Flick Threshold							
Access	Bit	7	6	5	4	3	2	1	0
R/W	Name	Flick Threshold Value							
Byte 2	Default	50D							

10.2.14 Active Channels 0x0DH

		Active Chan 0							
Access	Bit	7	6	5	4	3	2	1	0
R/W	Name					CH3	CH2	CH1	CH0
Byte 0	Default	0x0FH							



11 Specifications

11.1 Absolute Maximum Specifications

The following absolute maximum parameters are specified for the device:

Exceeding these maximum specifications may cause damage to the device.

- Operating temperature -20°C to 85°C
- Supply Voltage (VDDHI – GND) 3.6V
- Maximum pin voltage VDDHI + 0.5V (may not exceed VDDHI max)
- Maximum continuous current (for specific Pins) 10mA
- Minimum pin voltage GND - 0.5V
- Minimum power-on slope 100V/s
- ESD protection ±8kV (Human body model)

Table 11.1 IQS263 Self Capacitive General Operating Conditions¹

DESCRIPTION	Conditions	PARAMETER	MIN	TYP	MAX	UNIT
Supply voltage		V _{DDHI}	1.8	3.3V	3.6	V
Internal regulator output	1.8 ≤ V _{DDHI} ≤ 3.6	V _{REG}	1.62	1.7	1.79	V
Streaming mode*	3.3V	80Hz		180		µA
Event Mode		80Hz		90	150	µA
Low Power Setting 8**		128ms		4	6.5	µA
Low Power Setting 16**		256ms		3	4	µA

Table 11.2 IQS263 Projected Capacitive General Operating Conditions

DESCRIPTION	Conditions	PARAMETER	MIN	TYP	MAX	UNIT
Supply voltage		V _{DDHI}	1.8	3.3V	3.6	V
Internal regulator output	1.8 ≤ V _{DDHI} ≤ 3.6	V _{REG}	1.62	1.7	1.79	V
Streaming mode	3.3V	80Hz	-	305		µA
Event Mode		80Hz	-	230		µA
Low Power Setting 8**		128ms	-	5	11	µA
Low Power Setting 16**		256ms	-	4	6	µA

* Current consumption for streaming mode will differ with number of bytes read, speed and pull up resistor values

** LP interval period = Low power value x 16ms

¹Current values shown in this datasheet, does not include dissipation through I²C pull up resistors unless streaming mode is indicated.



Table 11.3 Start-up and shut-down slope Characteristics

DESCRIPTION	Conditions	PARAMETER	MIN	MAX	UNIT
Power On Reset	V_{DDHI} Slope $\geq 100V/s$ @25°C	POR		1.6	V
Brown Out Detect	V_{DDHI} Slope $\geq 100V/s$ @25°C	BOD	1.05		V

Table 11.4 Electrode Specifications – Self Capacitance

DESCRIPTION	Conditions	PARAMETER	MAX	UNIT
Parasitic Capacitance CX to GND		C_P	120	pF
Series Resistor	$C_P = 120pF$	R_S	10	kΩ

Table 11.5 Electrode Specifications – Mutual Capacitance

DESCRIPTION	Conditions	PARAMETER	MIN	MAX	UNIT
Parasitic Capacitance Tx to GND		C_T		100	pF
Parasitic Capacitance Rx to GND		C_R		100	pF
Mutual Capacitance		C_M	0.1	10	pF
Series Resistor		R_{TX}		10	kΩ
Series Resistor	$C_M = 1pF$	R_{RX}		1	kΩ



Table 11.6 ATI Times

Turbo Mode Off								
Oscillator	2MHZ				4MHZ			
Target value	Low		High		Low		High	
Channels active	1	3	1	3	1	3	1	3
Typical time [ms]	625	625	630	630	310	300	313	305
Worst case	850 (34 cycles @25ms per cycle)							
Turbo Mode On								
Oscillator	2MHZ				4MHZ			
Target value	Low		High		Low		High	
Channels active	1	3	1	3	1	3	1	3
Typical time [ms]	200	350	240	420	105	175	120	205
Worst case	500 - 600 (34 cycles estimate)							
ATI Error / Failure								
Worst case Including re-tries		4.7 seconds (189 cycles @25ms per cycle)			Something is wrong with settings or electrode(s)			

12 Packaging Information

12.1 MSOP-10

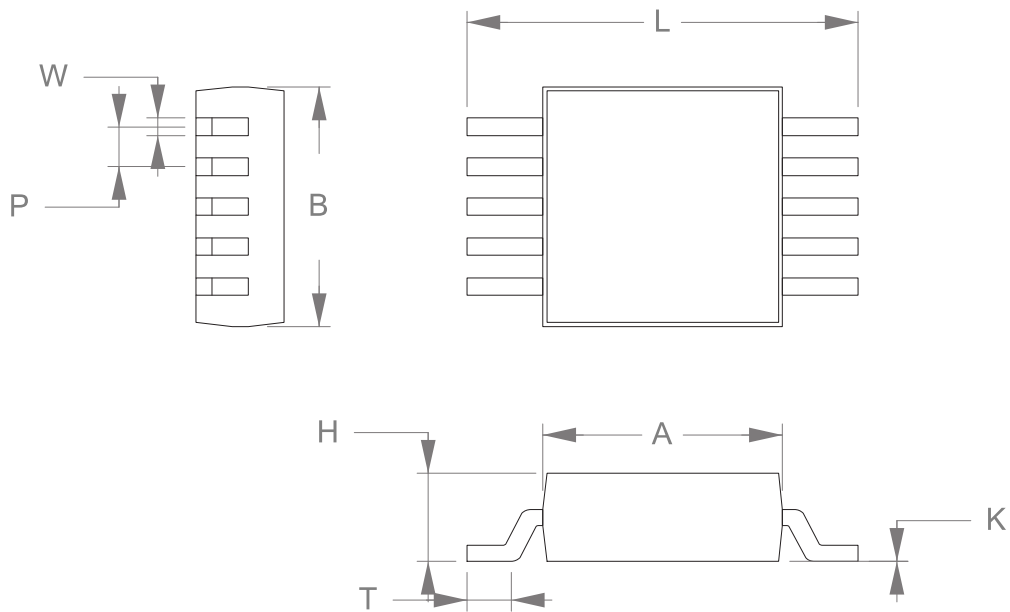

Figure 12.1 MSOP-10 Package Dimensions.

Table 12.1 MSOP-10 Package Dimensions.

DIMENSION	MIN	MAX	Unit
A	2.90	3.10	mm
B	2.90	3.10	mm
H	0.775	1.05	mm
K	0.025	0.10	mm
L	4.75	5.05	mm
T	0.40	0.80	mm
Pitch	0.5		mm
W	0.17	0.27	mm

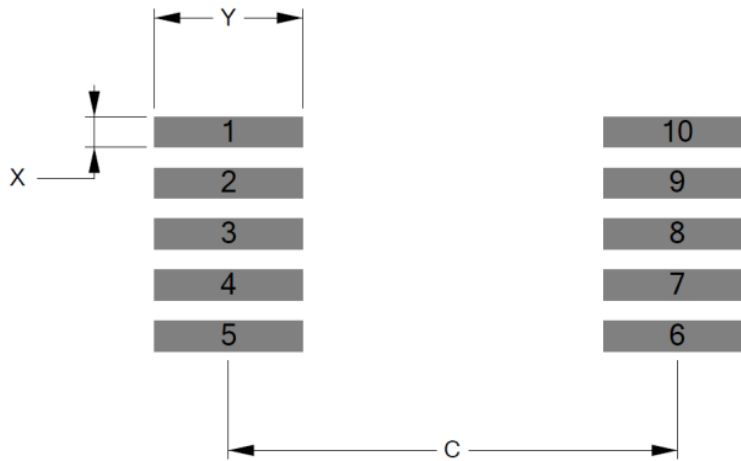

Figure 12.2 MSOP-10 Footprint.

Table 12.2 MSOP-10 Footprint Dimensions from Figure 12.2.

Dimension	[mm]
Pitch	0.50
C	4.40
Y	1.45
X	0.30

12.2 DFN10

Table 12.3 DFN-10 Package dimensions (bottom)

Dimension	[mm]
A	3 ±0.1
B	0.5
C	0.25
D	n/a
F	3 ±0.1
L	0.4
P	2.4
Q	1.65

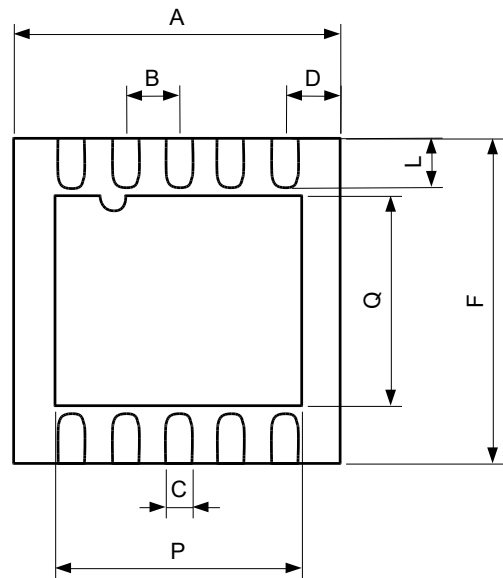

Figure 12.3 DFN-10 Package dimensions (bottom). Note that the saddle need to be connected to GND on the PCB.

Table 12.4 DFN-10 Package dimensions (side)

Dimension	[mm]
G	0.05
H	0.65
I	0.7-0.8

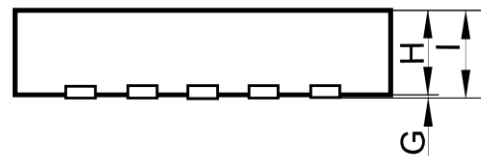

Figure 12.4 DFN-10 Package dimensions (side)

Table 12.5 DFN-10 Landing dimensions

Dimension	[mm]
A	2.4
B	1.65
C	0.8
D	0.5
E	0.3
F	3.2

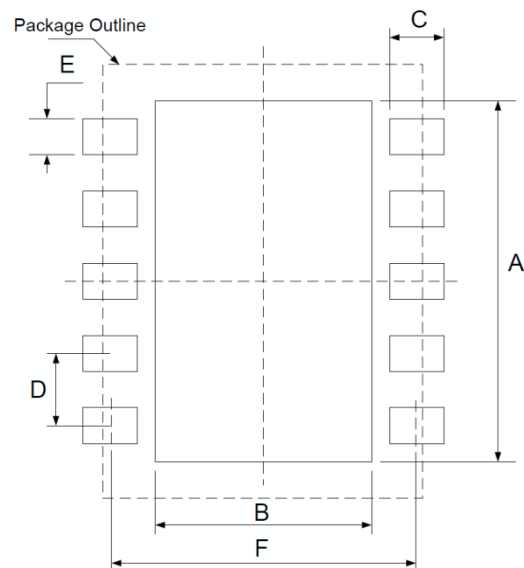
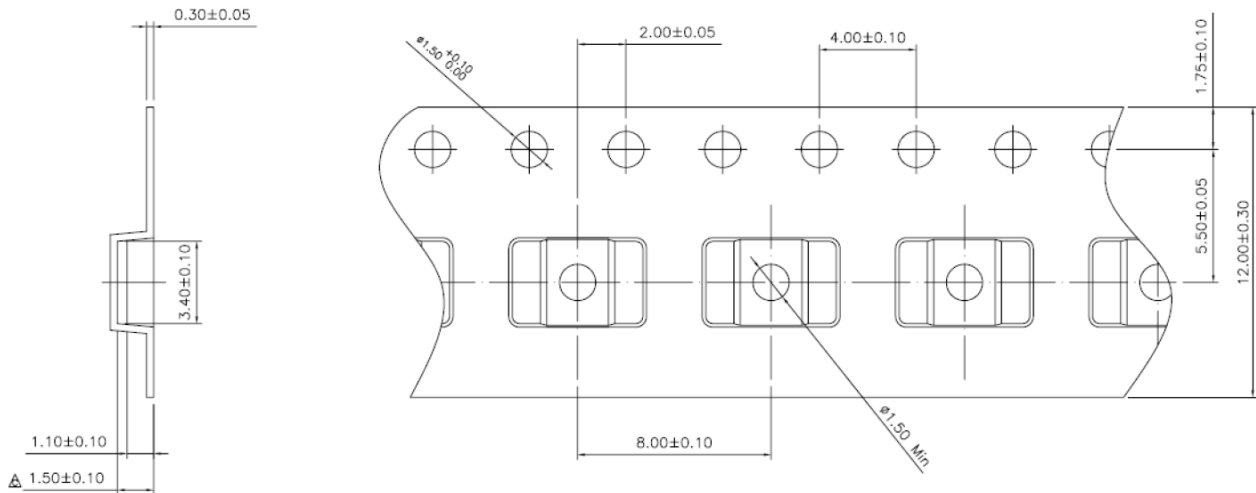

Figure 12.5 DFN-10 Landing dimensions



12.3 Tape and Reel Specification

12.3.1 MSOP10



NOTES:

1. 10 sprocket hole pitch cumulative tolerance ± 0.2
2. Camber not to exceed 1mm in 100mm
3. Material: Black conductive Polystyrene
4. Ao and Bo measured on a plane 0.3mm above the bottom of the pocket
5. Ko measured from a plane on the inside bottom of the pocket to the top surface of the carrier
6. Pocket position relative to sprocket hole measured as true position of pocket, not pocket hole.
7. Pocket center and pocket hole center must be same position

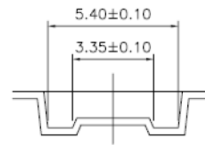
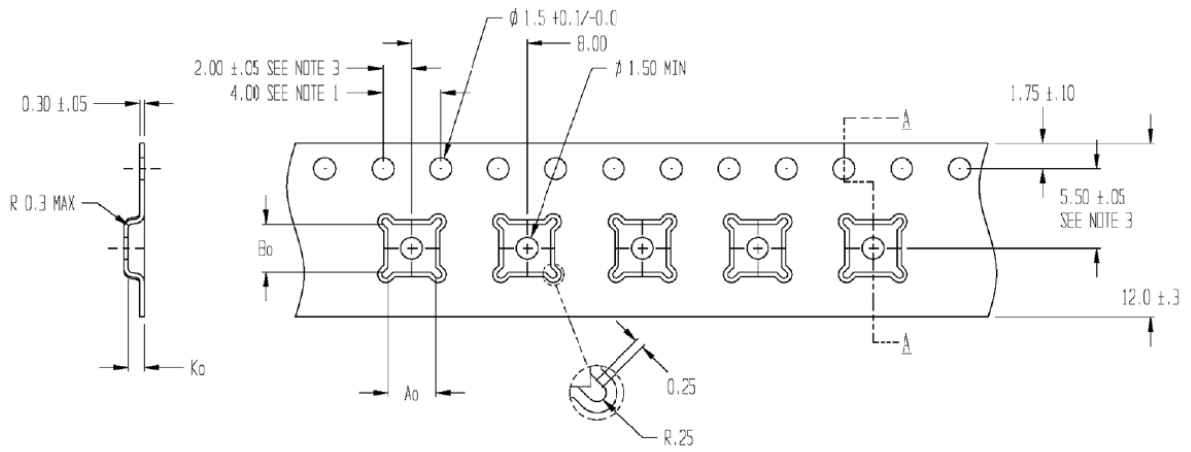

Figure 12.6 MSOP-10 Tape Specification. Bulk orientation LT.



12.3.2 DFN10 (3x3)



SECTION A - A

A0=3.30
B0=3.30
K0=1.10

NOTES:

- 1、 10 SPROCKET HOLE PITCH CUMULATIVE TOLERANCE ± 0.2
- 2、 CAMBER IN COMPLIANCE WITH EIA 481
- 3、 POCKET POSITION RELATIVE TO SPROCKET HOLE
MEASURED AS TRUE POSITION OF POCKET, NOT POCKET HOLE

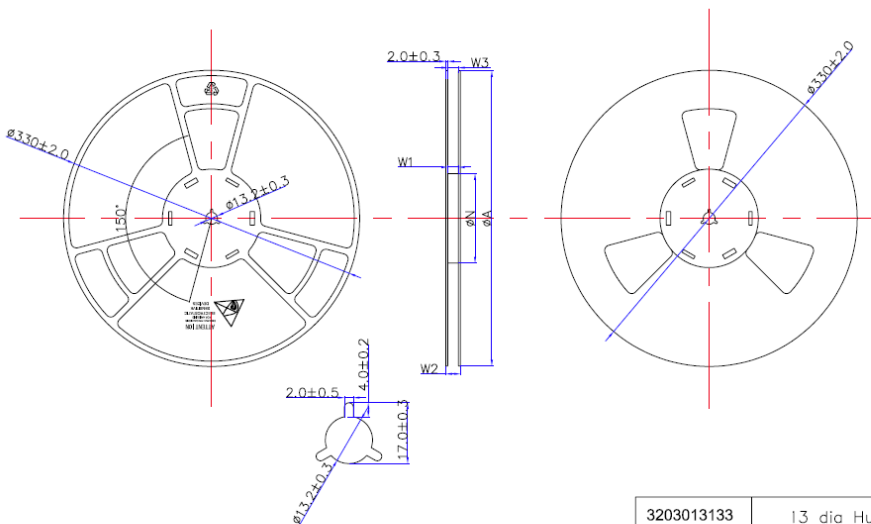

3203013133	13 dia Hub4 12mm width PS B
3203013213	13 dia Hub4 16mm width PS B
3203013253	13 dia Hub4 24mm width PS B

PRODUCT SPECIFICATIONS					
TYPE WIDTH	ØA	ØN	W1 _(Min)	W2 _(Max)	W3 _(Max)
12MM	330±2.0	100±1.0	12.4	18.4	15.4
16mm	330±2.0	100±1.0	16.4	22.4	19.4
24MM	330±2.0	100±1.0	24.4	30.4	27.4



12.4 Package MSL

Moisture Sensitivity Level (MSL) relates to the packaging and handling precautions for some semiconductors. The MSL is an electronic standard for the time period in which a moisture sensitive device can be exposed to ambient room conditions (approximately 30°C/85%RH see J-STD033C for more info) before reflow occur.

Table 12.6 MSL

Package	Level (duration)
MSOP-10	MSL 1 (Unlimited at ≤30 °C/85% RH) Reflow profile peak temperature < 260 °C for < 25 seconds Number of Reflow ≤ 3
DFN10 (3x3)	MSL 1 (Unlimited at ≤30 °C/85% RH) Reflow profile peak temperature < 260 °C for < 25 seconds Number of Reflow ≤ 3



13 Device Marking

13.1 Top Marking

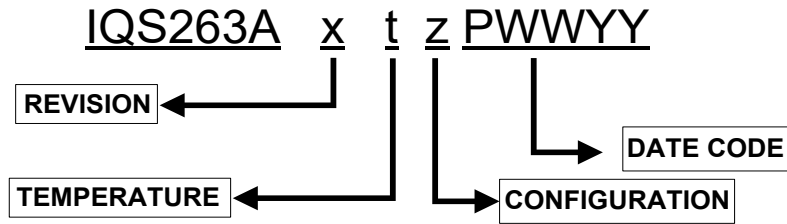

REVISION	x	=	IC Revision Number
TEMPERATURE RANGE	t	=	i -20°C to 85°C (Industrial)
		=	c 0°C to 70°C (Commercial)
IC CONFIGURATION	z	=	Configuration (Hexadecimal)
DATE CODE	P	=	Package House
	WW	=	Week
	YY	=	Year



14 Ordering Information

Order quantities will be subject to multiples of a full reel. Contact the official distributor for sample quantities. A list of the distributors can be found under the “Distributors” section of www.azoteq.com.

14.1 MSOP-10 Package

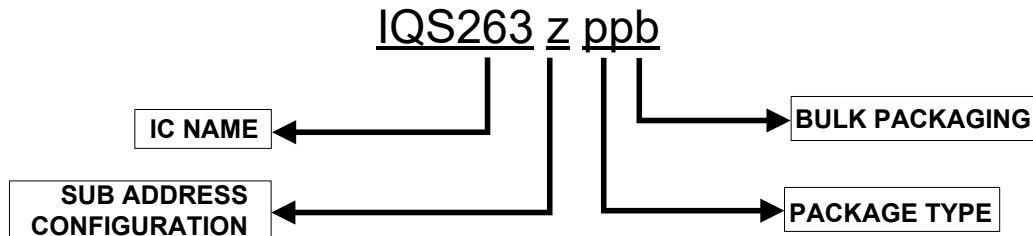

IC NAME	IQS263	=	IQS263
CONFIGURATION	z	=	Sub Address Configuration (hexadecimal) 0 = 44H 1 = 45H 2 = 46H 3 = 47H
PACKAGE TYPE	MS	=	MSOP-10
BULK PACKAGING	R	=	Reel MSOP - 4000pcs/reel

14.2 DFN Package

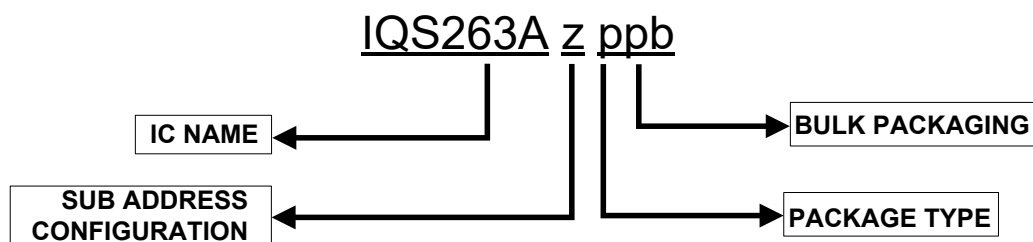

IC NAME	IQS263A	=	IQS263
CONFIGURATION	z	=	Sub Address Configuration (hexadecimal) 0 = 44H 1 = 45H 2 = 46H 3 = 47H
PACKAGE TYPE	DN	=	DFN10 (3x3)
BULK PACKAGING	R	=	Reel DNF10 (3x3) – 3000pcs/reel



	USA	Asia	South Africa
Physical Address	11940 Jollyville Suite 120-S Austin TX 78750 USA	Room 501A, Block A, T-Share International Centre, Taoyuan Road, Nanshan District, Shenzhen, Guangdong, PRC	1 Bergsig Avenue Paarl 7646 South Africa
Postal Address	11940 Jollyville Suite 120-S Austin TX 78750 USA	Room 501A, Block A, T-Share International Centre, Taoyuan Road, Nanshan District, Shenzhen, Guangdong, PRC	PO Box 3534 Paarl 7620 South Africa
Tel	+1 512 538 1995	+86 755 8303 5294 ext 808	+27 21 863 0033
Email	info@azoteq.com	info@azoteq.com	info@azoteq.com

*Visit www.azoteq.com
for a list of distributors and worldwide representation.*

Patents as listed on www.azoteq.com/patents-trademarks/ may relate to the device or usage of the device.

Azoteq®, Crystal Driver , IQ Switch®, ProxSense®, ProxFusion®, LightSense™, SwipeSwitch™, and the  logo are trademarks of Azoteq.

The information in this Datasheet is believed to be accurate at the time of publication. Azoteq uses reasonable effort to maintain the information up-to-date and accurate, but does not warrant the accuracy, completeness or reliability of the information contained herein. All content and information are provided on an "as is" basis only, without any representations or warranties, express or implied, of any kind, including representations about the suitability of these products or information for any purpose. Azoteq disclaims all warranties and conditions with regard to these products and information, including but not limited to all implied warranties and conditions of merchantability, fitness for a particular purpose, title and non-infringement of any third party intellectual property rights. Azoteq assumes no liability for any damages or injury arising from any use of the information or the product or caused by, without limitation, failure of performance, error, omission, interruption, defect, delay in operation or transmission, even if Azoteq has been advised of the possibility of such damages. The applications mentioned herein are used solely for the purpose of illustration and Azoteq makes no warranty or representation that such applications will be suitable without further modification, nor recommends the use of its products for application that may present a risk to human life due to malfunction or otherwise. Azoteq products are not authorized for use as critical components in life support devices or systems. No licenses to patents are granted, implicitly, express or implied, by estoppel or otherwise, under any intellectual property rights. In the event that any of the abovementioned limitations or exclusions does not apply, it is agreed that Azoteq's total liability for all losses, damages and causes of action (in contract, tort (including without limitation, negligence) or otherwise) will not exceed the amount already paid by the customer for the products. Azoteq reserves the right to alter its products, to make corrections, deletions, modifications, enhancements, improvements and other changes to the content and information, its products, programs and services at any time or to move or discontinue any contents, products, programs or services without prior notification. For the most up-to-date information and binding Terms and Conditions please refer to www.azoteq.com.