

# POE 10/100/1000 BASE-T Single Port SMD LAN Transformer Module

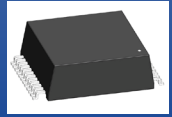

ALAN110001



18.3 x 16.5 x 6.4 mm  
 19.5 x 13.9 x 5.7 mm  
**RoHS/RoHS II Compliant**  
 MSL = 1

## Features

- Meets IEEE 802.3af standards
- Supports speed up to 1 Gbps
- Power Over Ethernet up to 30 Watts
- Current capability up to 350 mA per pair
- Operating temperature range up to -40°C to +125°C
- Compatible with major IC's for Ethernet applications
- High performance magnetics for EMI suppression and common mode noise rejection
- 1CT:1CT TX and RX Transformers

## Applications

- Fast and gigabit Ethernet
- Hubs, servers, switches, routers, access points
- IP cameras, surveillance, and phone
- Industrial computers and robotics
- Networking and communications
- Broadcast video
- Set top box

## Part Identification

ALAN110001 - [ ] [ ] [ ] [ ]

Package Size
3: 24-Pin Option 1*
4: 24-Pin Option 2*

Schematic
J11
J41
J61

Operating Temp.
E: 0 °C to +70 °C
D: -40 °C to +85 °C
J: -40 °C to +105 °C
K: -40 °C to +125 °C

Packaging
T: Tape and Reel*

\*Package size "3: 24-Pin Option 1": T= 400 pcs/reel  
 \*Package size "4: 24-Pin Option 2": T= 550 pcs/reel

# POE 10/100/1000 BASE-T Single Port SMD LAN Transformer Module

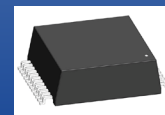

ALAN110001



18.3 x 16.5 x 6.4 mm  
19.5 x 13.9 x 5.7 mm  
RoHS/RoHS II Compliant  
MSL = 1

## Electrical Specifications at 25°C

Part Number	Insertion Loss (dB Max)	Return Loss (dB Min)					Crosstalk (dB Min)			CMRR (dB Min)			DCMR (dB Min)			
		1-100 MHz	1-30 MHz	40 MHz	50 MHz	60-80 MHz	100 MHz	100 kHz	1 MHz	50 MHz	100 MHz	30 MHz	60 MHz	100 MHz	30 MHz	60 MHz
ALAN110001-3J11	1.0	18	16	14	12	10	50	50	40	35	45	37	30	45	37	30
ALAN110001-3J41	1.0	18	16	14	12	10	50	50	40	35	45	37	30	45	37	30
ALAN110001-3J61	1.0	18	16	14	12	10	50	50	40	35	45	37	30	45	37	30
ALAN110001-4J11	1.0	18	16	14	12	10	50	50	40	35	45	37	30	45	37	30
ALAN110001-4J41	1.0	18	16	14	12	10	50	50	40	35	45	37	30	45	37	30
ALAN110001-4J61	1.0	18	16	14	12	10	50	50	40	35	45	37	30	45	37	30

Part Number	Inductance (uH Min)	Leakage Inductance (uH Max)	Interwinding Capacitance (pF Max)	DC Resistance (Ω Max)		Hi Pot (Vrms)	Weight (g)
				Primary	Secondary		
Test Condition	@100kHz, 0.1V, 8mA DC Bias	@100kHz, 0.1V TD to MX	@100kHz TD to MX			6 sec.	Per Piece
ALAN110001-3J11	350	0.5	35	1.0	1.2	1500	2.1
ALAN110001-3J41	350	0.5	35	1.0	1.0	1500	2.1
ALAN110001-3J61	350	0.5	35	1.2	1.0	1500	2.1
ALAN110001-4J11	350	0.5	35	1.0	1.2	1500	1.75
ALAN110001-4J41	350	0.5	35	1.0	1.0	1500	1.75
ALAN110001-4J61	350	0.5	35	1.2	1.0	1500	1.75

Standard	Current (mA Max)	Voltage (V)	Power Delivered per Port (W Max)
IEEE 802.3af: Type-1 / POE	350	@57 V Continuous	30

# POE 10/100/1000 BASE-T Single Port SMD LAN Transformer Module

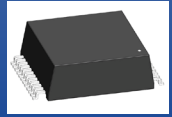

ALAN110001



18.3 x 16.5 x 6.4 mm  
19.5 x 13.9 x 5.7 mm  
RoHS/RoHS II Compliant  
MSL = 1

## Mechanical Dimensions

### 3: 24-pin Option 1

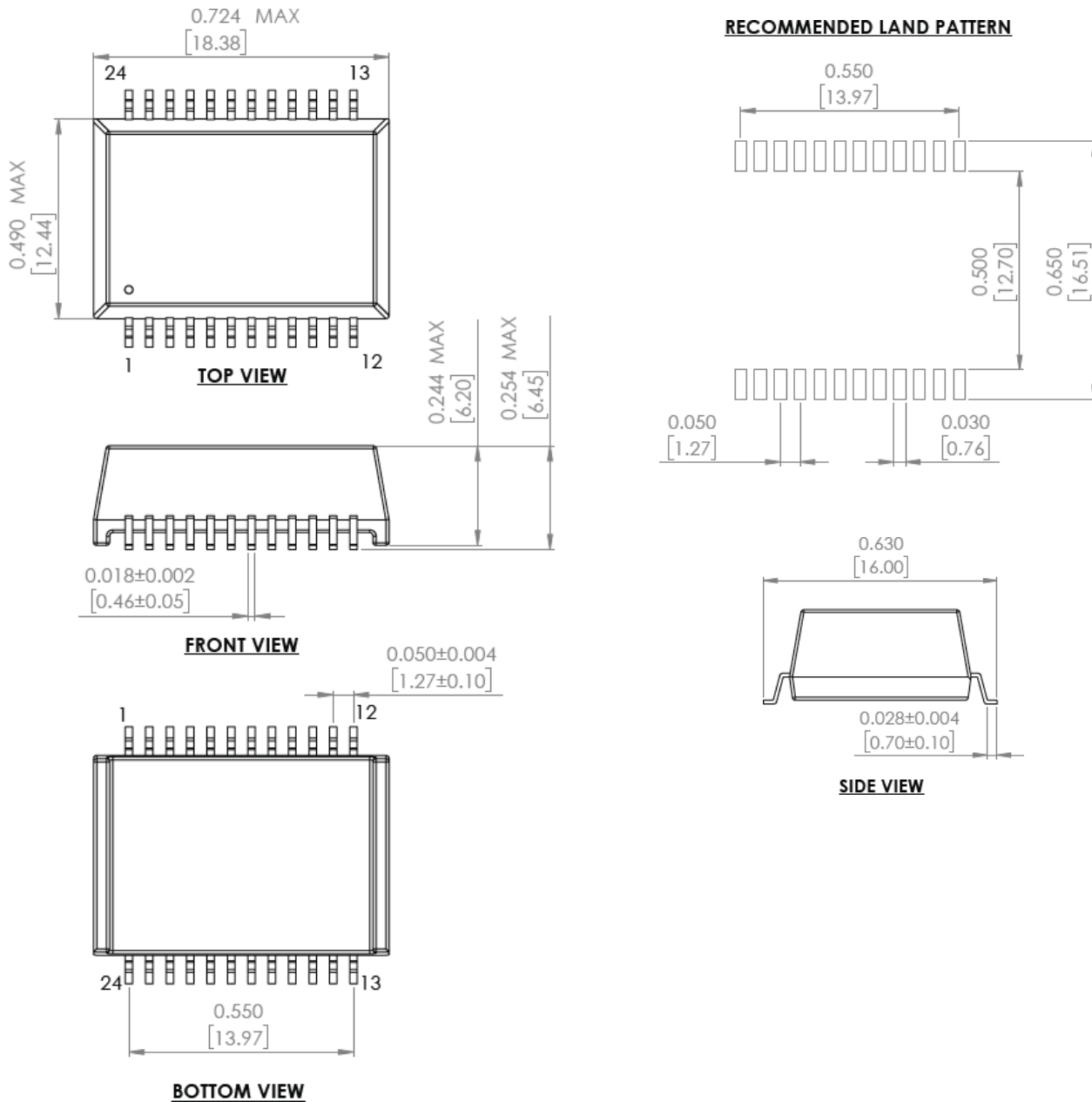

Unless otherwise specified, all tolerances are  $\pm 0.010$  [0.25]  
Dimensions: inch [mm]

# POE 10/100/1000 BASE-T Single Port SMD LAN Transformer Module

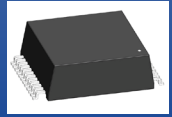

ALAN110001



18.3 x 16.5 x 6.4 mm  
19.5 x 13.9 x 5.7 mm  
RoHS/RoHS II Compliant  
MSL = 1

## Mechanical Dimensions

### 4: 24-pin Option 2

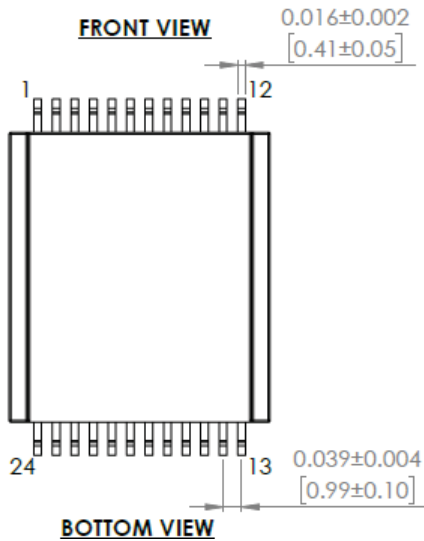
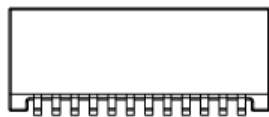
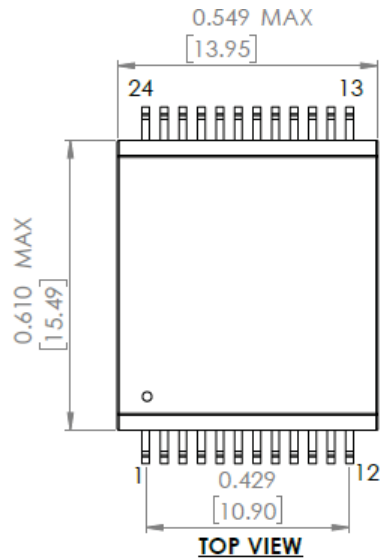

### RECOMMENDED LAND PATTERN

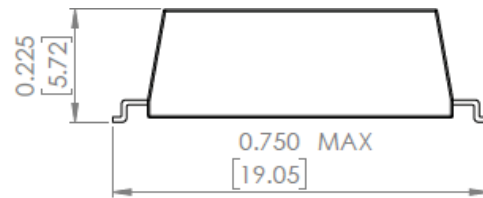
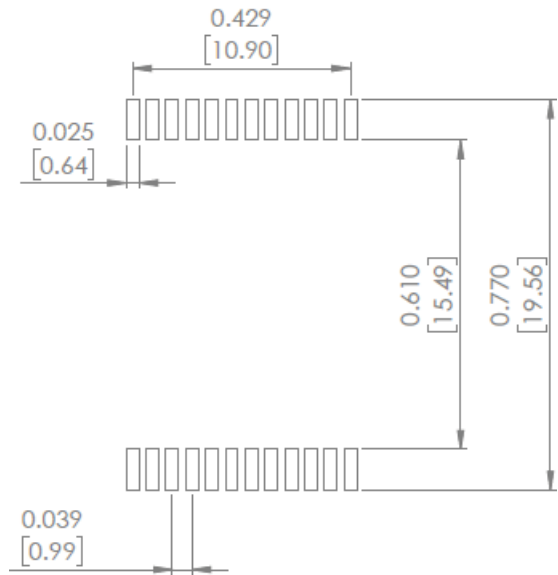

### SIDE VIEW

Unless otherwise specified, all tolerances are  $\pm 0.010$  [0.25]  
Dimensions: inch [mm]

# POE 10/100/1000 BASE-T Single Port SMD LAN Transformer Module

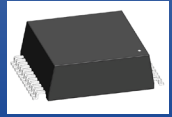

ALAN110001



18.3 x 16.5 x 6.4 mm  
 19.5 x 13.9 x 5.7 mm  
 RoHS/RoHS II Compliant  
 MSL = 1

## Schematics

### 24-Pin

#### J11

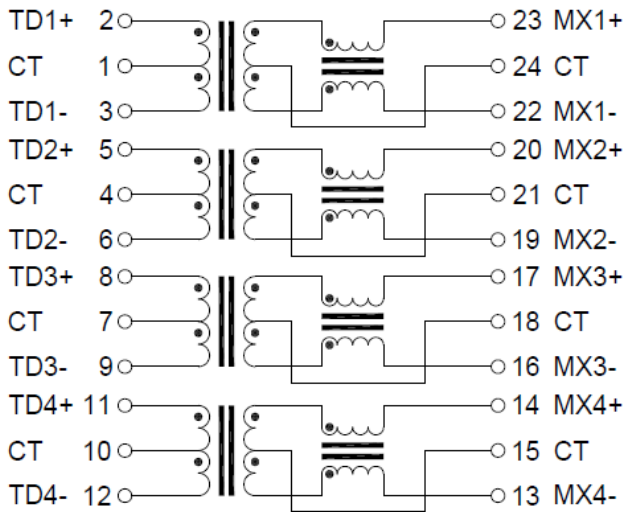

#### J41

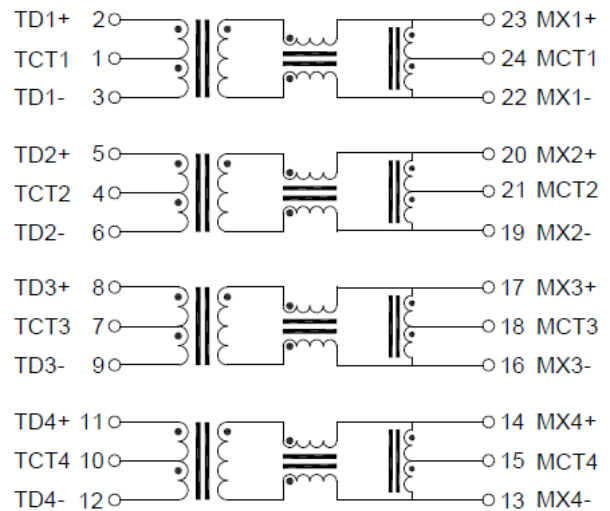

Contact Abracon for additional options.



5101 Hidden Creek Ln Spicewood TX 78669  
 Phone: 512-371-6159 | Fax: 512-351-8858  
 For terms and conditions of sales, please visit:  
[www.abracon.com](http://www.abracon.com)

REVISED: 10-8-21

ABRACON IS  
 ISO9001-2015  
 CERTIFIED

# POE 10/100/1000 BASE-T Single Port SMD LAN Transformer Module

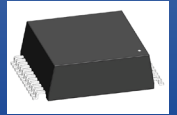

ALAN110001



18.3 x 16.5 x 6.4 mm  
19.5 x 13.9 x 5.7 mm  
RoHS/RoHS II Compliant  
MSL = 1

## Schematics

### 24-Pin

#### J61

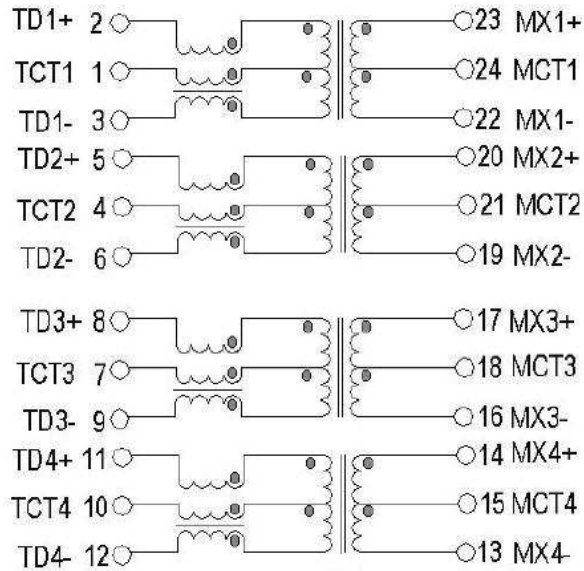

Contact Abracon for additional options.



5101 Hidden Creek Ln Spicewood TX 78669  
Phone: 512-371-6159 | Fax: 512-351-8858  
For terms and conditions of sales, please visit:  
[www.abracon.com](http://www.abracon.com)

REVISED: 10-8-21

ABRACON IS  
ISO9001-2015  
CERTIFIED

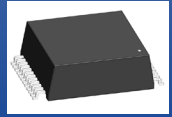

ALAN110001



18.3 x 16.5 x 6.4 mm  
 19.5 x 13.9 x 5.7 mm  
 RoHS/RoHS II Compliant  
 MSL = 1

**Reflow Profile**

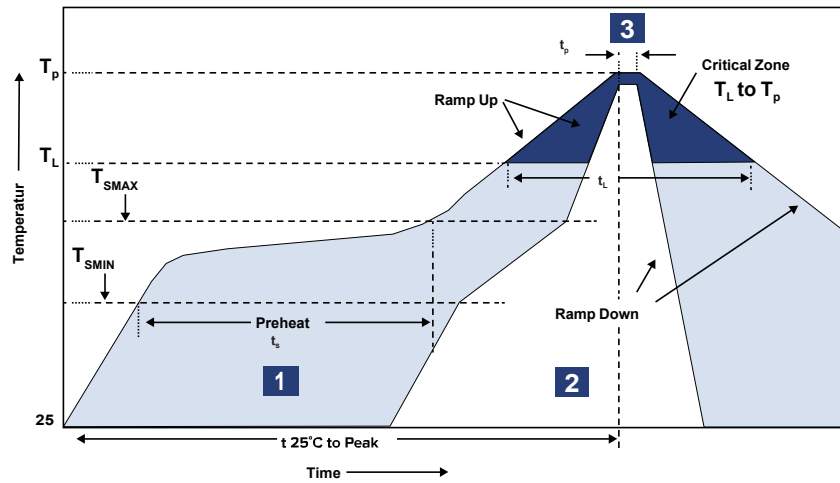

Zone	Description	Temperature	Time
1	Preheat / Soak	$T_s$ 150 °C ~ 200 °C	$t_s$ 60 ~ 120 sec.
2	Reflow	$T_L$ 217 °C	$t_L$ 60 ~ 150 sec.
3	Peak heat	$T_p$ 245 ± 5 °C	$t_p$ 20 ~ 40 sec.

# POE 10/100/1000 BASE-T Single Port SMD LAN Transformer Module

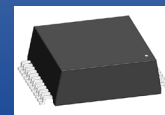

ALAN110001



18.3 x 16.5 x 6.4 mm  
 19.5 x 13.9 x 5.7 mm  
 RoHS/RoHS II Compliant  
 MSL = 1

## Packaging

### Package size option 3:

Tape and Reel: 400 pcs/reel  
 Pieces per Carton: 3,200  
 T&R per Carton: 8  
 Weight per Carton: 11.5 kg  
 Weight per Piece: 2.1 g  
 Dimension of the carton: 365 x 365 x 350 mm

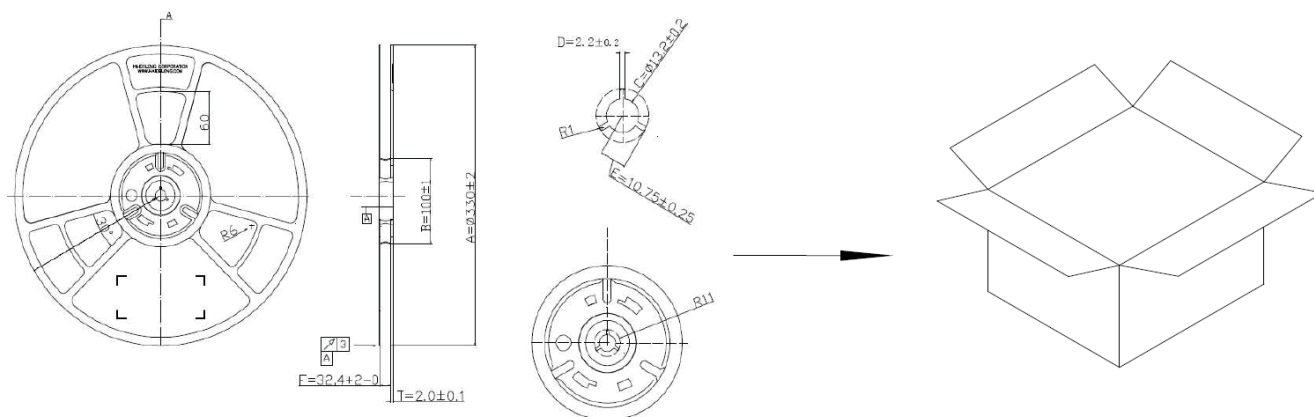
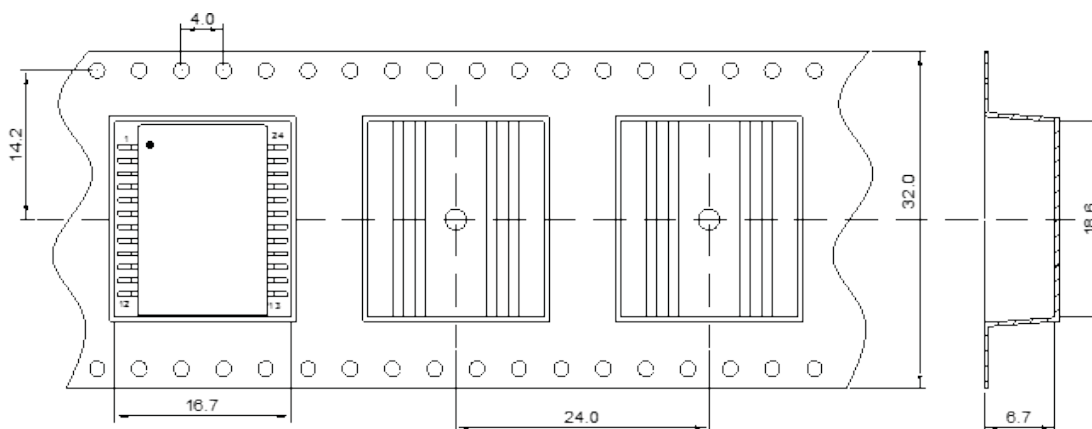

Dimensions: mm



5101 Hidden Creek Ln Spicewood TX 78669  
 Phone: 512-371-6159 | Fax: 512-351-8858  
 For terms and conditions of sales, please visit:  
[www.abracon.com](http://www.abracon.com)

REVISED: 10-8-21

ABRACON IS  
 ISO9001-2015  
 CERTIFIED



