

Features

- Schottky barrier diodes
- Low forward voltage drop
- High Junction Temperature
- Moisture sensitivity: level 1, per J-STD-020
- Plastic package has Underwriters Laboratory Flammability Classification 94V-0
- Add suffix "E" for Halogen Free
- Halogen-free according to IEC 61249-2-21 definition
- AEC-Q101 qualified



DO-214AA (SMB)

Typical Applications

For use in low voltage, high frequency inverters, free wheeling, and polarity protection application

Maximum Ratings (TA = 25 °C unless otherwise noted)						
Parameter	Symbol	SK57B SK57BE	SK58B SK58BE	SK59B SK59BE	SK5BB SK5BBE	Unit
Maximum repetitive peak reverse voltage	V _{RRM}	70	80	90	100	V
Maximum RMS voltage	V _{RMS}	42	56	63	70	V
Maximum DC blocking voltage	V _{DC}	70	80	90	100	V
Maximum average forward rectified current	I _{F(AV)}	5.0				A
Peak forward surge current 8.3 ms single half sine-wave superimposed on rated load	I _{FSM}	120				A
Operating junction and storage temperature range	T _J , T _{STG}	- 55 to + 150				°C

Electrical Characteristics (TA = 25 °C unless otherwise noted)							
Parameter	Test Conditions	Symbol	SK57B SK57BE	SK58B SK58BE	SK59B SK59BE	SK5BB SK5BBE	Unit
Maximum instantaneous forward voltage	I _F =5A, T _A =25°C	V _F	0.79				V
Maximum DC reverse current at rated DC blocking voltage	T _A =25°C	I _R	30				µA
	T _A =125°C		2000				
Typical junction capacitance	4.0 V, 1 MHz	C _J	96				pF

Thermal Characteristics						
Parameter	Symbol	SK57B SK57BE	SK58B SK58BE	SK59B SK59BE	SK5BB SK5BBE	Unit
Typical thermal resistance ⁽¹⁾	R _{θJA}	65				°C/W
	R _{θJC}	25				
	R _{θJL}	15				

Note1: Thermal resistance from junction to lead, mounted on PCB with 8.0×8.0mm copper pads

Ratings and Characteristics Curves

(TA = 25°C unless otherwise noted)

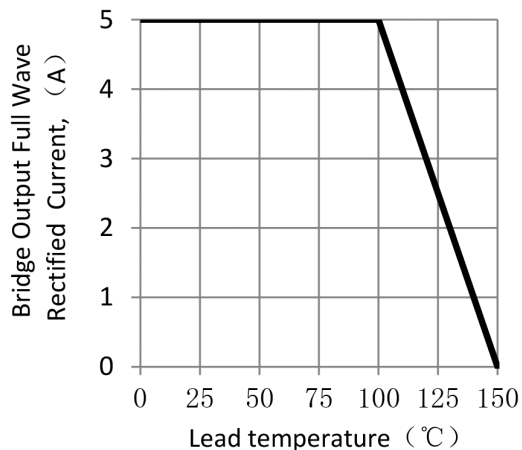

Figure 1. Forward Current Derating Curve

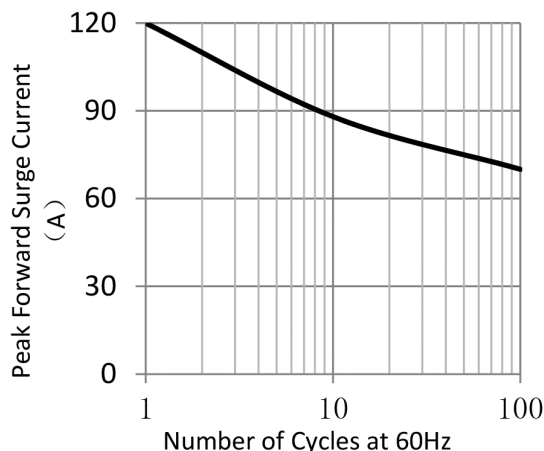

Figure 2. Maximum Non-Repetitive Peak Forward Surge Current

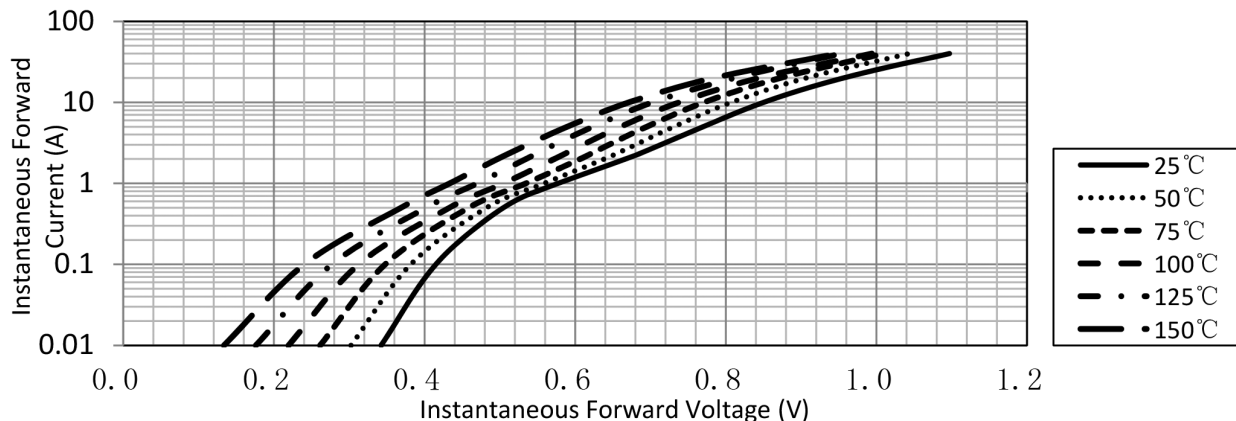

Figure 3. Typical Instantaneous Forward Characteristics

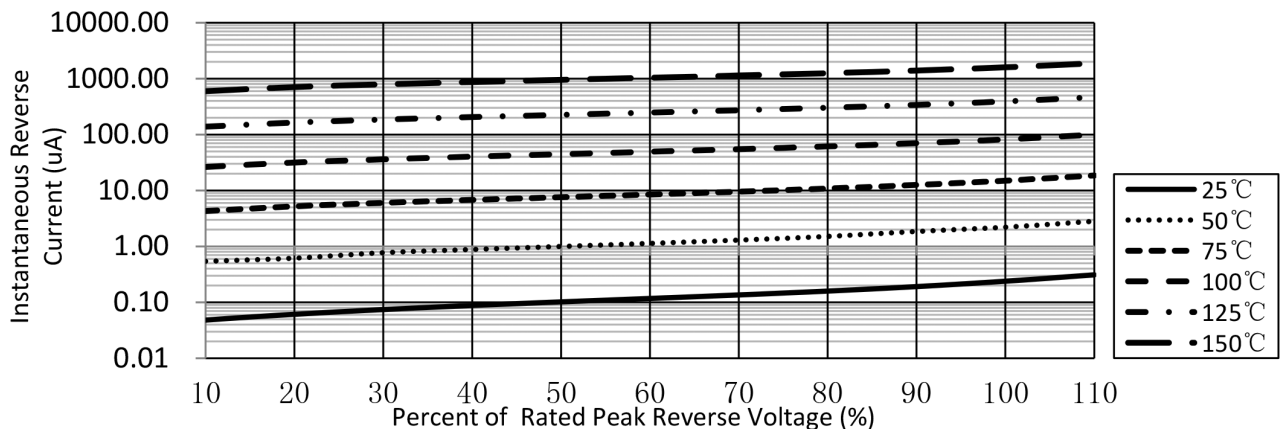
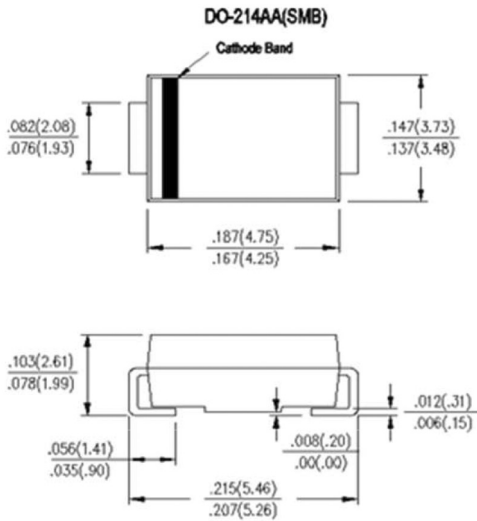

Figure 4. Typical Reverse Characteristics

Package Outline Dimensions

in inches (millimeters)



Mounting Pad Layout

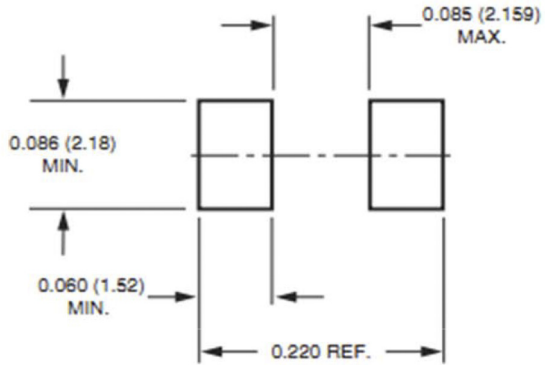

Packing Information

3000 pcs/Reel, 18 Reels/Box; 12mm Tape, 13" Reel

Tape & Reel Specification

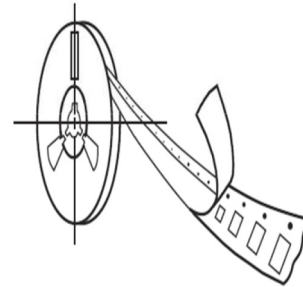
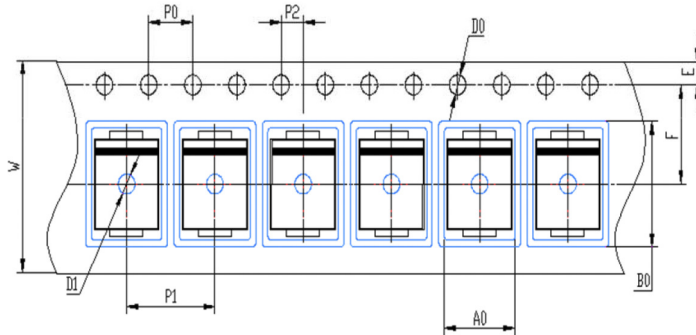

Symbol	SMB (mm)
W	12 ± 0.2
E	1.75 ± 0.1
F	5.5 ± 0.05
D0	1.5 ± 0.1
D1	1.50 +0.1/-0
P0	4.0 ± 0.1
P1	8.0 ± 0.1
P2	2.0 ± 0.05
A0	3.95 ± 0.1
B0	5.74 ± 0.1

Soldering Parameters

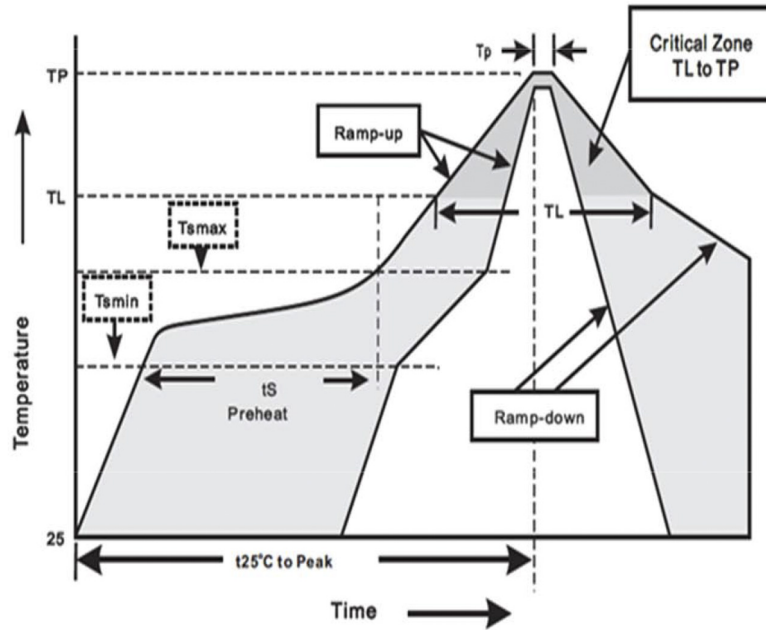

Reflow Soldering		Sn-Pb Eutectic Assembly	Pb-Free assembly
Pre Heat	- Temperature Min (Ts(min))	100°C	150°C
	- Temperature Max (Ts(max))	150°C	200°C
	- Time (min to max) (ts)	60 – 120 secs	60 – 180 secs
Average ramp up rate (Liquidus) Temp (TL) to peak		3°C/second max	3°C/second max
TS(max) to TL - Ramp-up Rate		3°C/second max	3°C/second max
Reflow	- Temperature (TL) (Liquidus)	183°C	217°C
	- Time (min to max) (ts)	60 – 150 seconds	60 – 150 seconds
Peak Temperature (TP)		240+0/-5 °C	240+0/-5°C
Time within 5°C of actual peak Temperature (tp)		10 –30 seconds	20 – 40 seconds
Ramp-down Rate		6°C/second max	6°C/second max
Time 25°C to peak Temperature (TP)		6 minutes Max.	8 minutes Max.
Do not exceed		260°C	260°C

Wave Soldering	
Peak Temperature :	260+0/-5°C
Dipping Time :	10 seconds
Soldering :	1 time