

# XPT IGBT

tentative

$$V_{CES} = 1200V$$

$$I_{C25} = 32A$$

$$V_{CE(sat)} = 1.8V$$

ISOPLUS™ Surface Mount Power Device  
 Boost Topology  
 XPT IGBT

Part number

**IXA20RG1200DHGLB**



Backside: isolated

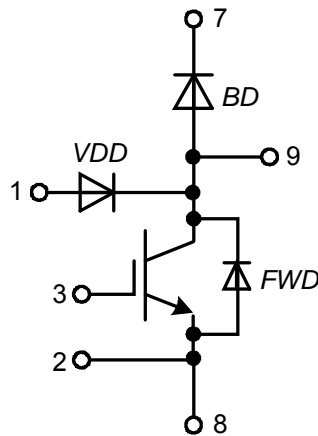
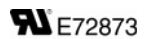

### Features / Advantages:

- XPT IGBT
  - low saturation voltage
  - positive temperature coefficient for easy paralleling
  - fast switching
  - short tail current for optimized performance in resonant circuits
- Sonic™ diode
  - fast reverse recovery
  - low operating forward voltage
  - low leakage current
  - low temperature dependency of reverse recovery
- Vcesat detection diode (VDD)
  - integrated into package
  - very fast diode

### Applications:

- AC drives
  - brake chopper
- PFC
  - boost chopper
- Switched reluctance drives

### Package: SMPD

- Industry convenient outline
- RoHS compliant
- Epoxy meets UL 94V-0
- Soldering pins for PCB mounting
- Backside: DCB ceramic
- Reduced weight
- Advanced power cycling
- Isolation Voltage: 3000 V~

| Free Wheeling Diode FWD |  |  |                         | Ratings |      |            |   |
|-------------------------|--|--|-------------------------|---------|------|------------|---|
| Symbol                  | Definition                                   | Conditions                                   | min.                    | typ.    | max. | Unit       |   |
| $V_{RSM}$               | max. non-repetitive reverse blocking voltage | $T_{VJ} = 25^{\circ}C$                       |                         |         | 1200 | V          |   |
| $V_{RRM}$               | max. repetitive reverse blocking voltage     | $T_{VJ} = 25^{\circ}C$                       |                         |         | 1200 | V          |   |
| $I_R$                   | reverse current, drain current               | $V_R = 1200 V$                               | $T_{VJ} = 25^{\circ}C$  |         | 25   | $\mu A$    |   |
|                         |  | $V_R = 1200 V$                               | $T_{VJ} = 125^{\circ}C$ |         | 0.4  | mA         |   |
| $V_F$                   | forward voltage drop                         | $I_F = 20 A$                                 | $T_{VJ} = 25^{\circ}C$  |         | 2.20 | V          |   |
|                         |  |  | $T_{VJ} = 125^{\circ}C$ |         | 2.20 | V          |   |
|                         |  | $I_F = 40 A$                                 | $T_{VJ} = 25^{\circ}C$  |         |      |            | V |
|                         |  |  | $T_{VJ} = 125^{\circ}C$ |         |      |            | V |
| $I_{FAV}$               | average forward current                      | $T_C = 80^{\circ}C$<br>rectangular $d = 0.5$ | $T_{VJ} = 150^{\circ}C$ |         | 18   | A          |   |
| $V_{FO}$                | threshold voltage                            | } for power loss calculation only            | $T_{VJ} = 150^{\circ}C$ |         | 1.29 | V          |   |
| $r_F$                   | slope resistance                             |  |                         |         | 41   | m $\Omega$ |   |
| $R_{thJC}$              | thermal resistance junction to case          |  |                         |         | 1.35 | K/W        |   |
| $R_{thCH}$              | thermal resistance case to heatsink          |  |                         | 0.40    |      | K/W        |   |
| $P_{tot}$               | total power dissipation                      |  | $T_C = 25^{\circ}C$     |         | 93   | W          |   |
| $I_{FSM}$               | max. forward surge current                   | $t = 10 ms; (50 Hz), sine; V_R = 0 V$        | $T_{VJ} = 45^{\circ}C$  |         | 150  | A          |   |
| $C_J$                   | junction capacitance                         | $V_R = 400 V f = 1 MHz$                      | $T_{VJ} = 25^{\circ}C$  |         | 10   | pF         |   |

| VCEsat Detection Diode VDD |  |  |                         | Ratings |      |            |  |
|----------------------------|--|--|-------------------------|---------|------|------------|--|
| Symbol                     | Definition                               | Conditions   | min.                    | typ.    | max. | Unit       |  |
| $V_{RRM}$                  | max. repetitive reverse blocking voltage | $T_{VJ} = 25^{\circ}C$                               |                         |         | 1200 | V          |  |
| $I_R$                      | reverse current, drain current           | $V_{R/D} = 1200 V$                                   | $T_{VJ} = 25^{\circ}C$  |         | 2    | $\mu A$    |  |
|                            |  | $V_{R/D} = 1200 V$                                   | $T_{VJ} = 125^{\circ}C$ |         | 0.03 | mA         |  |
| $V_F$                      | forward voltage drop                     | $I_F = 1 A$  | $T_{VJ} = 25^{\circ}C$  |         | 2.20 | V          |  |
|                            |  |  | $T_{VJ} = 125^{\circ}C$ |         | 1.80 | V          |  |
| $V_{FO}$                   | threshold voltage                        | } for power loss calculation only                    | $T_{VJ} = 150^{\circ}C$ |         | 1.30 | V          |  |
| $r_F$                      | slope resistance                         |  |                         |         | 390  | m $\Omega$ |  |
| $C_J$                      | junction capacitance                     | $V_R = 400 V; f = 1 MHz$                             | $T_{VJ} = 25^{\circ}C$  |         | tbd  | pF         |  |
| $I_{RM}$                   | max. reverse recovery current            | } $V_R = 100 V; I_F = 1 A$<br>$-di/dt = 100 A/\mu s$ | $T_{VJ} = 25^{\circ}C$  |         | 2.3  | A          |  |
| $t_{rr}$                   | reverse recovery time                    |  | $T_{VJ} = 125^{\circ}C$ |         | tbd  | A          |  |
|                            |  |  | $T_{VJ} = 25^{\circ}C$  |         | 40   | ns         |  |
|                            |  |  | $T_{VJ} = 125^{\circ}C$ |         | tbd  | ns         |  |

| Boost IGBT            |                                       |  |                                | Ratings |          |               |  |
|-----------------------|---------------------------------------|--|--------------------------------|---------|----------|---------------|--|
| Symbol                | Definition                            | Conditions   | min.                           | typ.    | max.     | Unit          |  |
| $V_{CES}$             | collector emitter voltage             | $T_{VJ} = 25^{\circ}\text{C}$  |                                |         | 1200     | V             |  |
| $V_{GES}$             | max. DC gate voltage                  |  |                                |         | $\pm 20$ | V             |  |
| $V_{GEM}$             | max. transient collector gate voltage |  |                                |         | $\pm 30$ | V             |  |
| $I_{C25}$             | collector current                     | $T_C = 25^{\circ}\text{C}$   |                                |         | 32       | A             |  |
| $I_{C80}$             |                                       | $T_C = 80^{\circ}\text{C}$   |                                |         | 23       | A             |  |
| $P_{tot}$             | total power dissipation               | $T_C = 25^{\circ}\text{C}$   |                                |         | 125      | W             |  |
| $V_{CE(sat)}$         | collector emitter saturation voltage  | $I_C = 15\text{ A}; V_{GE} = 15\text{ V}$  |                                | 1.8     | 2.1      | V             |  |
|                       |                                       |  |                                | 2       |          | V             |  |
| $V_{GE(th)}$          | gate emitter threshold voltage        | $I_C = 0.6\text{ mA}; V_{CE} = V_{CE}$   | 5.4                            | 5.9     | 6.5      | V             |  |
| $I_{CES}$             | collector emitter leakage current     | $V_{CE} = V_{CES}; V_{GE} = 0\text{ V}$  |                                |         | 0.1      | mA            |  |
|                       |                                       |  |                                |         | 0.1      | mA            |  |
| $I_{GES}$             | gate emitter leakage current          | $V_{GE} = \pm 20\text{ V}$   |                                |         | 500      | nA            |  |
| $Q_{G(on)}$           | total gate charge                     | $V_{CE} = 600\text{ V}; V_{GE} = 15\text{ V}; I_C = 15\text{ A}$   |                                | 48      |          | nC            |  |
| $t_{d(on)}$           | turn-on delay time                    | inductive load<br>$V_{CE} = 600\text{ V}; I_C = 15\text{ A}$<br>$V_{GE} = \pm 15\text{ V}; R_G = 56\ \Omega$ | $T_{VJ} = 125^{\circ}\text{C}$ |         | 70       | ns            |  |
| $t_r$                 | current rise time                     |  |                                |         | 40       | ns            |  |
| $t_{d(off)}$          | turn-off delay time                   |  |                                |         | 250      | ns            |  |
| $t_f$                 | current fall time                     |  |                                |         | 100      | ns            |  |
| $E_{on}$              | turn-on energy per pulse              |  |                                |         | 1.55     | mJ            |  |
| $E_{off}$             | turn-off energy per pulse             |  |                                |         | 1.7      | mJ            |  |
| <b>RBSOA</b>          | reverse bias safe operating area      | $V_{GE} = \pm 15\text{ V}; R_G = 56\ \Omega$   | $T_{VJ} = 125^{\circ}\text{C}$ |         |          |               |  |
| $I_{CM}$              |                                       | $V_{CEmax} = 1200\text{ V}$  |                                |         | 45       | A             |  |
| <b>SCSOA</b>          | short circuit safe operating area     | $V_{CEmax} = 1200\text{ V}$  | $T_{VJ} = 125^{\circ}\text{C}$ |         |          |               |  |
| $t_{sc}$              | short circuit duration                | $V_{CE} = 900\text{ V}; V_{GE} = \pm 15\text{ V}$  |                                |         | 10       | $\mu\text{s}$ |  |
| $I_{sc}$              | short circuit current                 | $R_G = 56\ \Omega; \text{non-repetitive}$  |                                |         | 60       | A             |  |
| $R_{thJC}$            | thermal resistance junction to case   |  |                                |         | 1        | K/W           |  |
| $R_{thCH}$            | thermal resistance case to heatsink   |  |                                | 0.30    |          | K/W           |  |
| <b>Boost Diode BD</b> |                                       |  |                                |         |          |               |  |
| $V_{RRM}$             | max. repetitive reverse voltage       |  |                                |         | 1200     | V             |  |
| $I_{F25}$             | forward current                       |  | $T_C = 25^{\circ}\text{C}$     |         | 27       | A             |  |
| $I_{F80}$             |                                       |  | $T_C = 80^{\circ}\text{C}$     |         | 18       | A             |  |
| $V_F$                 | forward voltage                       | $I_F = 20\text{ A}$  | $T_{VJ} = 25^{\circ}\text{C}$  |         | 2.20     | V             |  |
|                       |                                       |  | $T_{VJ} = 125^{\circ}\text{C}$ | 1.90    |          | V             |  |
| $I_R$                 | reverse current                       | $V_R = V_{RRM}$  | $T_{VJ} = 25^{\circ}\text{C}$  |         | 0.03     | mA            |  |
|                       |                                       |  | $T_{VJ} = 125^{\circ}\text{C}$ | 0.12    |          | mA            |  |
| $Q_{rr}$              | reverse recovery charge               | $V_R = 600\text{ V}$<br>$-di_F/dt = 400\text{ A}/\mu\text{s}$<br>$I_F = 20\text{ A}; V_{GE} = 0\text{ V}$    | $T_{VJ} = 125^{\circ}\text{C}$ |         | 3        | $\mu\text{C}$ |  |
| $I_{RM}$              | max. reverse recovery current         |  |                                |         | 20       | A             |  |
| $t_{rr}$              | reverse recovery time                 |  |                                |         | 350      | ns            |  |
| $E_{rec}$             | reverse recovery energy               |  |                                |         | 0.7      | mJ            |  |
| $R_{thJC}$            | thermal resistance junction to case   |  |                                |         | 1.35     | K/W           |  |
| $R_{thCH}$            | thermal resistance case to heatsink   |  |                                | 0.4     |          | K/W           |  |

tentative

| Package SMPD  |  | Ratings              |      |      |      |      |
|---------------|--|----------------------|------|------|------|------|
| Symbol        | Definition   | Conditions           | min. | typ. | max. | Unit |
| $I_{RMS}$     | RMS current  | per terminal         |      |      | 100  | A    |
| $T_{stg}$     | storage temperature  |                      | -55  |      | 150  | °C   |
| $T_{vj}$      | virtual junction temperature                                 |                      | -55  |      | 150  | °C   |
| <b>Weight</b> |  |                      |      | 8.5  |      | g    |
| $F_C$         | mounting force with clip                                     |                      | 40   |      | 130  | N    |
| $V_{ISOL}$    | isolation voltage  | t = 1 second         | 3000 |      |      | V    |
|               |  | t = 1 minute         | 2500 |      |      | V    |
| $d_{Spp/App}$ | creepage distance on surface   striking distance through air | terminal to terminal | 1.6  |      |      | mm   |
|               |  | terminal to backside | 4.0  |      |      | mm   |



### Part number

- I = IGBT
- X = XPT IGBT
- A = Gen 1 / std
- 20 = Current Rating [A]
- RG = boost configuration
- 1200 = Reverse Voltage [V]
- D = IGBT
- H = XPT IGBT
- G = Gen 1 / std
- LB = SMPD-B

| Ordering    | Part Number          | Marking on Product | Delivery Mode | Quantity | Code No. |
|-------------|----------------------|--------------------|---------------|----------|----------|
| Standard    | IXA20RG1200DHGLB     | IXA20RG1200DHGLB   | Blister       | 45       | 512349   |
| Alternative | IXA20RG1200DHGLB-TRR | IXA20RG1200DHGLB   | Tape & Reel   | 200      | 512370   |

| Similar Part     | Package | Voltage class |
|------------------|---------|---------------|
| IXA30RG1200DHGLB | SMPD-B  | 1200          |
| IXA40RG1200DHGLB | SMPD-B  | 1200          |

## Outlines SMPD

A ( 8 : 1 )

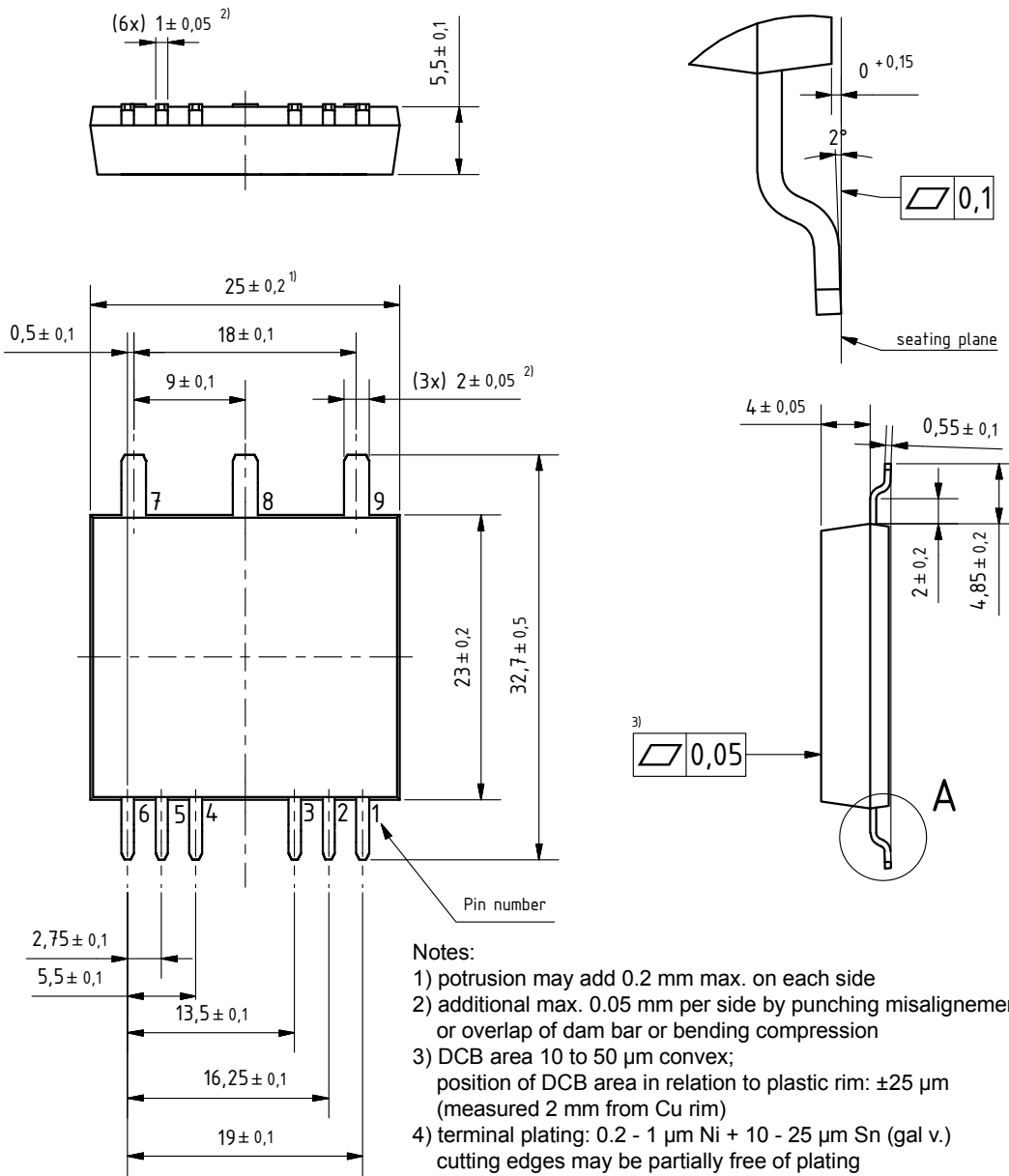

## Boost IGBT

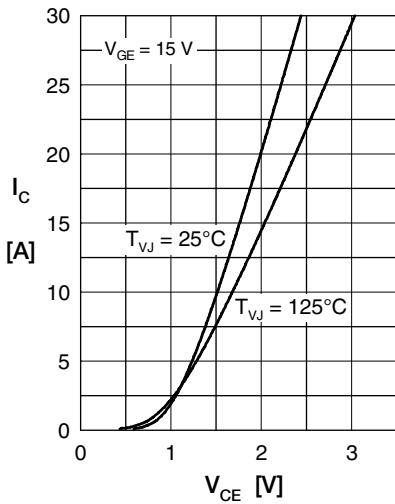

Fig. 1 Typ. output characteristics

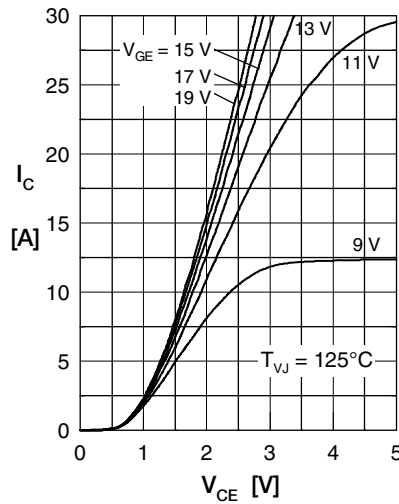

Fig. 2 Typ. output characteristics



Fig. 3 Typ. transfer characteristics



Fig. 4 Typ. turn-on gate charge

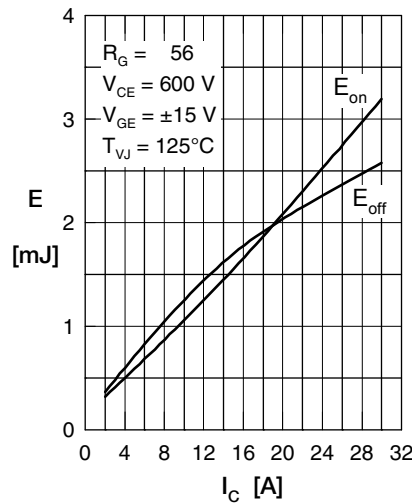

Fig. 5 Typ. switching energy versus collector current

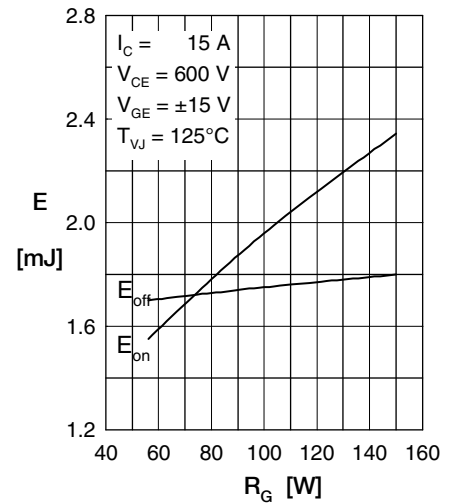

Fig. 6 Typ. switching energy versus gate resistance



Fig. 7 Typ. transient thermal impedance junction to case

## Boost Diode BD

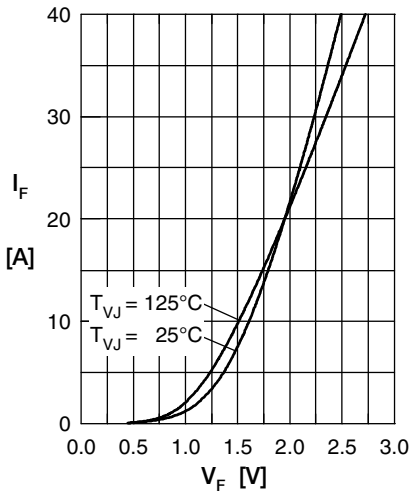

Fig. 1 Typ. Forward current versus  $V_F$

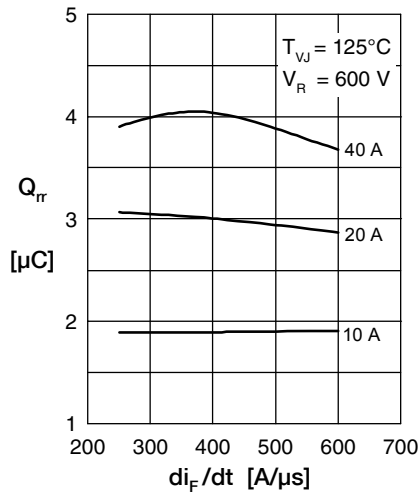

Fig. 2 Typ. reverse recov. charge  $Q_{rr}$  versus  $di_F/dt$

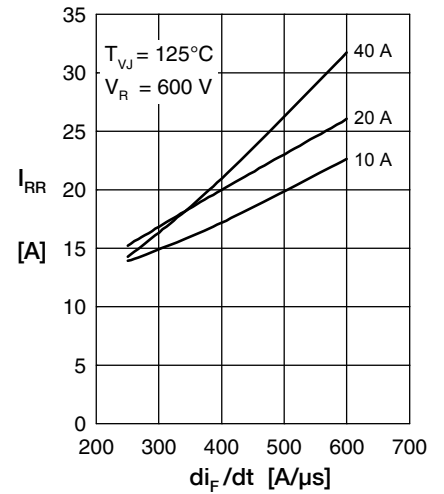

Fig. 3 Typ. peak reverse current  $I_{RRM}$  versus  $di_F/dt$

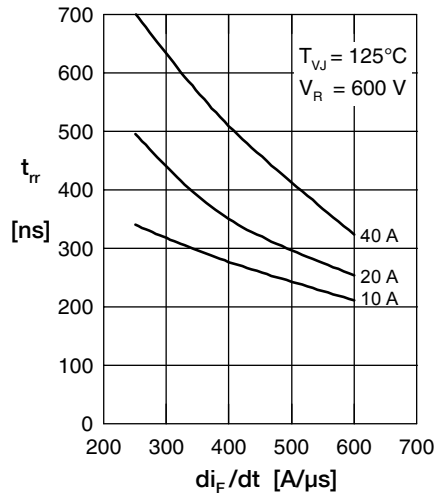

Fig. 4 Dynamic parameters  $Q_{rr}$ ,  $I_{RRM}$  versus  $di/dt$

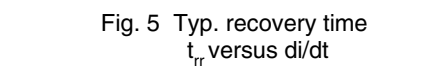

Fig. 5 Typ. recovery time  $t_{rr}$  versus  $di/dt$

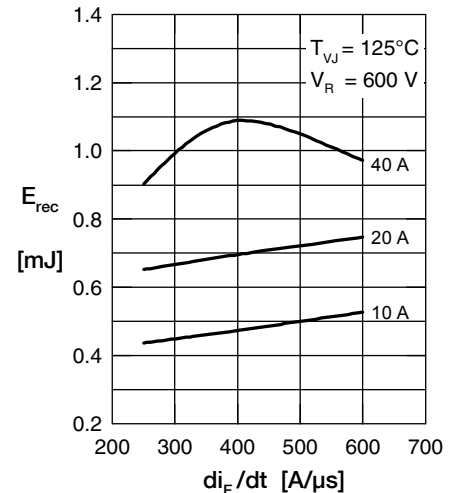

Fig. 6 Typ. recovery energy  $E_{rec}$  versus  $di/dt$

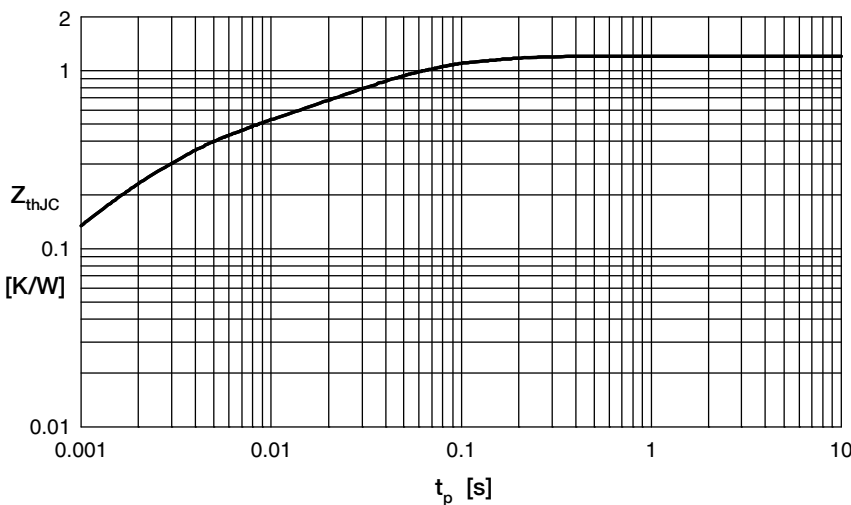

Fig. 7 Typ. transient thermal impedance junction to case



---

Disclaimer Notice - Information furnished is believed to be accurate and reliable. However, users should independently evaluate the suitability of and test each product selected for their own applications. Littelfuse products are not designed for, and may not be used in, all applications. Read complete Disclaimer Notice at [www.littelfuse.com/disclaimer-electronics](http://www.littelfuse.com/disclaimer-electronics).