

Mechanical Dimensions: Inches [mm]

Tolerances  $\pm 0.012$  [0.3] Unless Otherwise Specified

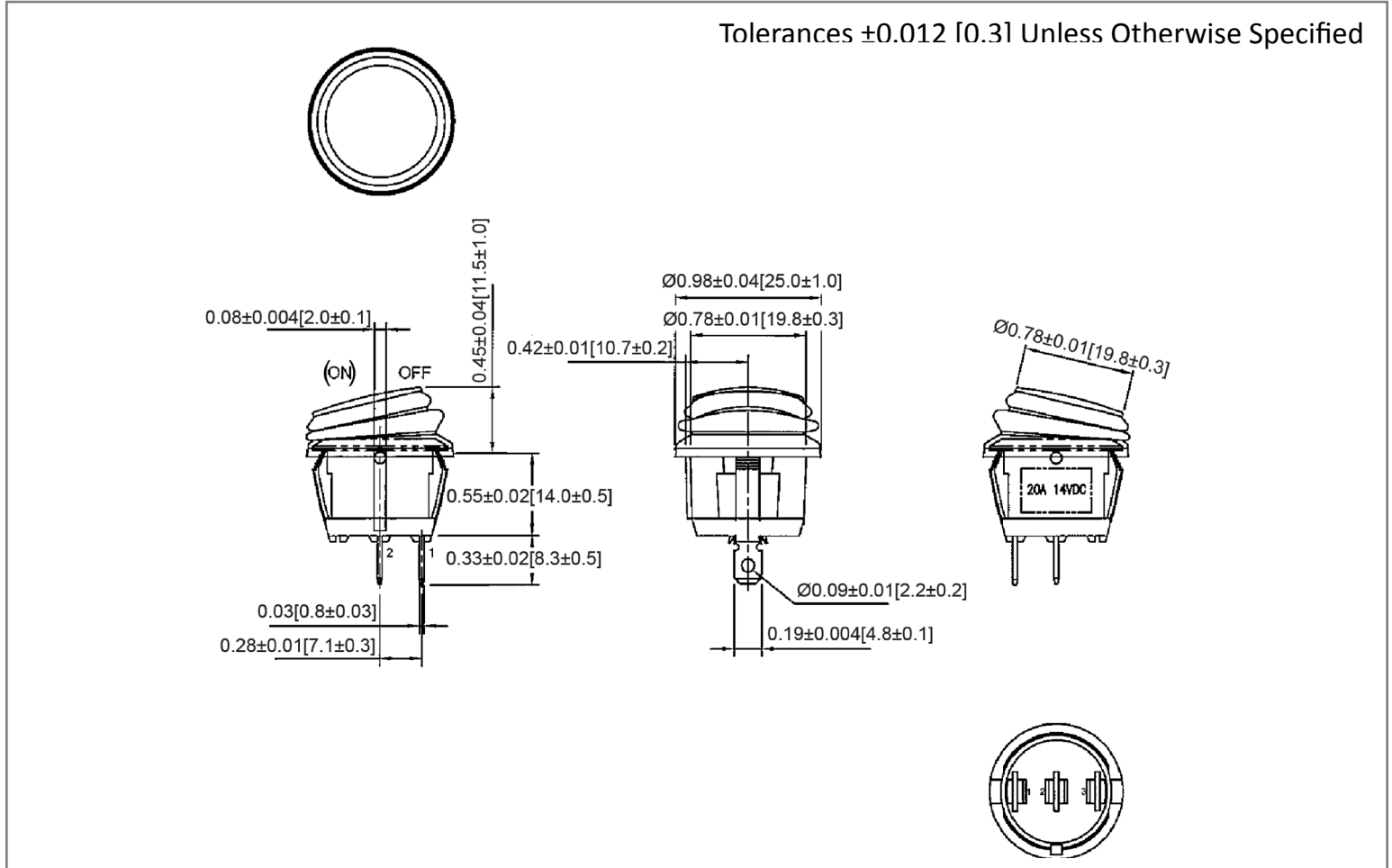

Mounting Hole

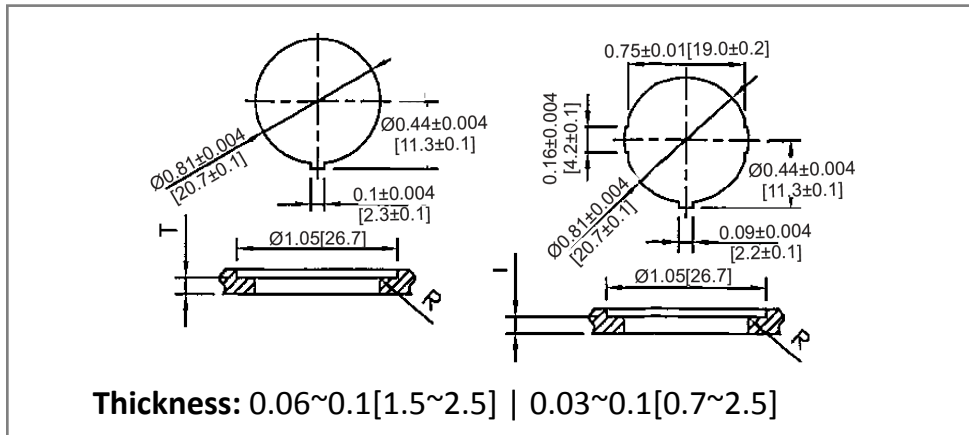

Circuit Diagram

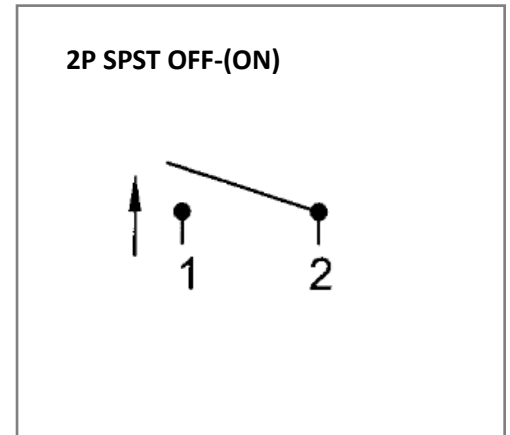

Electrical Specifications

Rating	20A 14V DC, 10A 28V DC
Contact Resistance	50m ohm Max
Insulation Resistance	DC 500V 100M ohm Min
Dielectric Strength	AC 1500V 1 minute
Operation Temperature	-25°C ~ 85°C

Material Specifications

Frame	Black, Nylon 66 (94-V2)
Actuator	Black, PC (94-V2)
Waterproof Rubber	Black, Silicone
Terminals	Silver plated, Copper alloy
Waterproof	IP65

Rev	Date of issue	Revision Notes	Designed	Approved
B	06-08-2021	Initial Drawing	RC	OF