

## GaAs MMIC HIGH ISOLATION SMT SPDT SWITCH, DC - 6 GHz

### Typical Applications

The HMC233G8 is ideal for:

- Telecom Infrastructure
- Microwave Radio & VSAT
- Military Radios, Radar & ECM
- Space Systems
- Test Instrumentation

### Features

- Isolation: 44 dB @ 2.0 GHz  
31 dB @ 6.0 GHz
- Insertion Loss: 1.5 dB Typical @ 4.0 GHz
- Non-Reflective Design
- Hermetic Surface Mount Package

### Functional Diagram

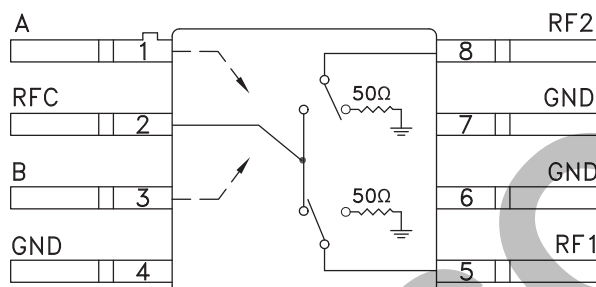

### General Description

The HMC233G8 is a broadband high isolation non-reflective GaAs MESFET SPDT switch in a hermetic surface mount package. Covering DC to 6 GHz, the switch features >44 dB isolation up to 2 GHz and >31 dB isolation up to 6 GHz. The switch operates using complementary negative control voltage logic lines of -5/0V and requires no bias supply.

### Electrical Specifications, $T_A = +25^\circ\text{C}$ , With 0/-5V Control, 50 Ohm System

Parameter	Frequency	Min.	Typ.	Max.	Units
Insertion Loss	DC - 2.0 GHz		1.3	1.6	dB
	DC - 4.0 GHz		1.5	1.8	dB
	DC - 6.0 GHz		1.8	2.2	dB
Isolation	DC - 2.0 GHz	39	44		dB
	DC - 4.0 GHz	30	35		dB
	DC - 6.0 GHz	26	31		dB
Return Loss	"On State"	DC - 5.0 GHz	17		dB
		DC - 6.0 GHz	14		dB
Return Loss RF1, RF2	"Off State"	DC - 4.0 GHz	12		dB
		DC - 6.0 GHz	8		dB
Input Power for 1 dB Compression	0.5 - 6.0 GHz	22	27		dBm
Input Third Order Intercept (Two-Tone Input Power= +7 dBm Each Tone, 1 MHz Tone Separation)	0.5 - 6.0 GHz		46		dBm
Switching Characteristics	DC - 6.0 GHz	tRISE, tFALL (10/90% RF)	3		ns
		tON, tOFF (50% CTL to 10/90% RF)	6		ns

Information furnished by Analog Devices is believed to be accurate and reliable. However, no responsibility is assumed by Analog Devices for its use, nor for any infringements of patents or other rights of third parties that may result from its use. Specifications subject to change without notice. No license is granted by implication or otherwise under any patent or patent rights of Analog Devices. Trademarks and registered trademarks are the property of their respective owners.

For price, delivery, and to place orders: Analog Devices, Inc., One Technology Way, P.O. Box 9106, Norwood, MA 02062-9106  
Phone: 781-329-4700 • Order online at [www.analog.com](http://www.analog.com)  
Application Support: Phone: 1-800-ANALOG-D

## GaAs MMIC HIGH ISOLATION SMT SPDT SWITCH, DC - 6 GHz

**Insertion Loss**

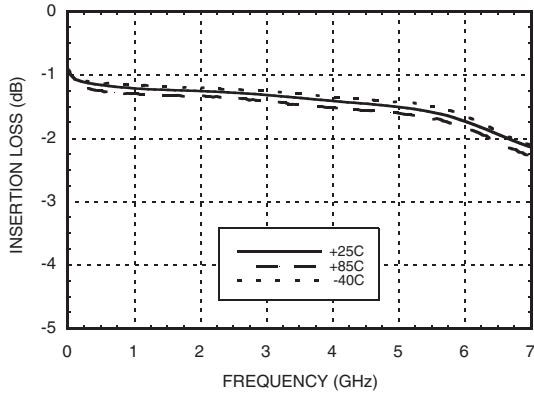

**Isolation**

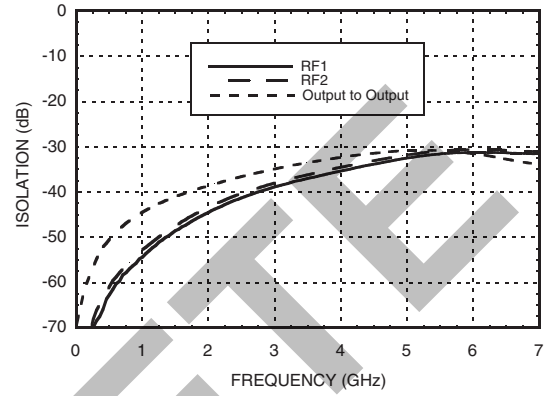

**Return Loss**

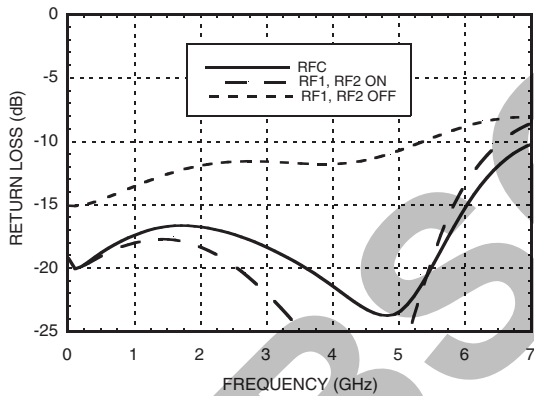

**0.1 and 1 dB Input Compression Point**

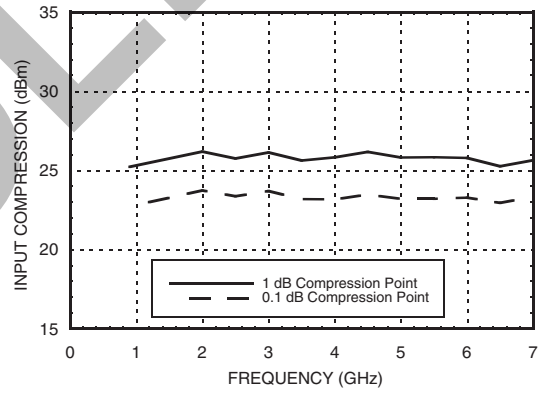

**Input Third Order Intercept Point**

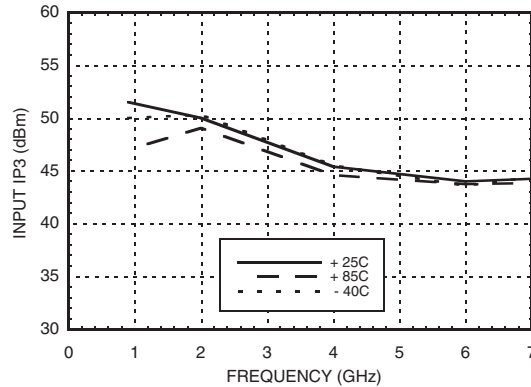

Information furnished by Analog Devices is believed to be accurate and reliable. However, no responsibility is assumed by Analog Devices for its use, nor for any infringements of patents or other rights of third parties that may result from its use. Specifications subject to change without notice. No license is granted by implication or otherwise under any patent or patent rights of Analog Devices. Trademarks and registered trademarks are the property of their respective owners.

For price, delivery, and to place orders: Analog Devices, Inc., One Technology Way, P.O. Box 9106, Norwood, MA 02062-9106 Phone: 781-329-4700 • Order online at [www.analog.com](http://www.analog.com) Application Support: Phone: 1-800-ANALOG-D

**GaAs MMIC HIGH ISOLATION SMT  
SPDT SWITCH, DC - 6 GHz**

**Absolute Maximum Ratings**

RF Input Power (Vctl= -5V) (0.5 - 6 GHz)	+30 dBm (@ +85 °C)
Control Voltage Range (A & B)	+1.0V to -7.5 Vdc
Hot Switch Power Level	+27 dBm
Channel Temperature	150 °C
Continuous P <sub>diss</sub> (T = 85 °C) (derate 4 mW/°C above 85 °C)	0.25 W
Thermal Resistance (Insertion Loss Path)	148 °C/W
Thermal Resistance (Terminated Path)	260 °C/W
Storage Temperature	-65 to +150 °C
Operating Temperature	-40 to +85 °C
ESD Sensitivity (HBM)	Class 1A

**Control Voltages**

State	Bias Condition
Low	0 to -0.2V @ 10 uA Max.
High	-5V @ 10 uA Typ. to -7V @ 45 uA Typ.

**Truth Table**

Control Input		Signal Path State	
A	B	RFC to RF1	RFC to RF2
High	Low	ON	OFF
Low	High	OFF	ON

Caution: Do not "Hot Switch" power levels greater than +27 dBm (Vctl = 0/-5 Vdc).



**ELECTROSTATIC SENSITIVE DEVICE  
OBSERVE HANDLING PRECAUTIONS**

**Outline Drawing**

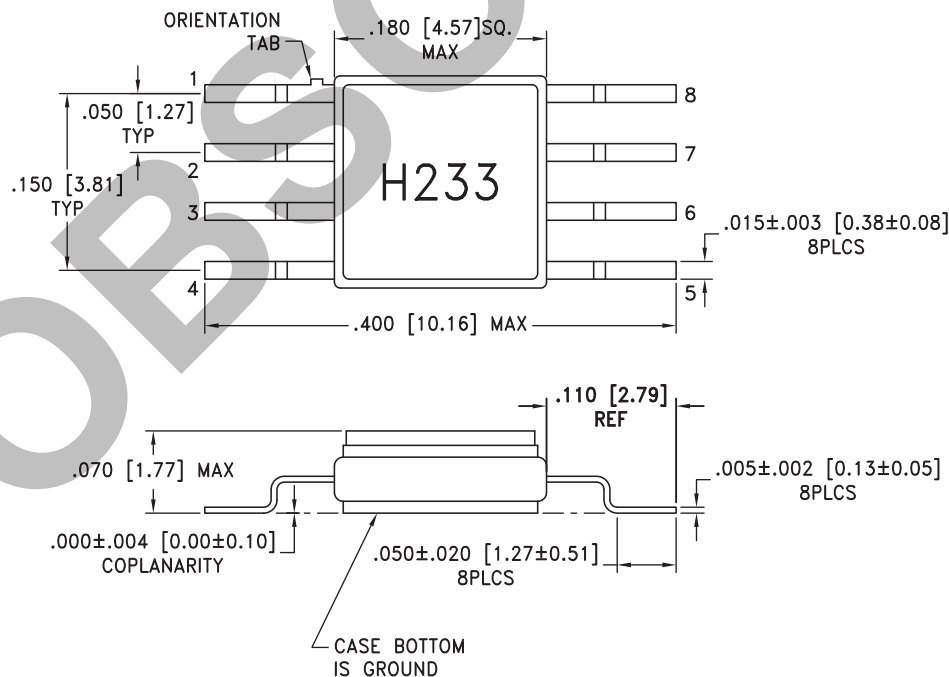

**NOTES:**

1. PACKAGE MATERIAL: ALUMINA LOADED BOROSILICATE GLASS.
2. LEADS, BASE, COVER MATERIAL: KOVAR™ (#7052 CORNING).
3. PLATING: ELECTROLYTIC GOLD 50 MICROINCHES MIN., OVER ELECTROLYTIC NICKEL 50 MICROINCHES MIN.
4. ALL DIMENSIONS ARE IN INCHES [MILLIMETERS].
5. TOLERANCES: .±005 [0.13] UNLESS OTHERWISE SPECIFIED.
6. ALL GROUND LEADS AND GROUND PADDLE MUST BE SOLDERED TO PCB RF GROUND.

## GaAs MMIC HIGH ISOLATION SMT SPDT SWITCH, DC - 6 GHz

### Suggested Driver Circuit

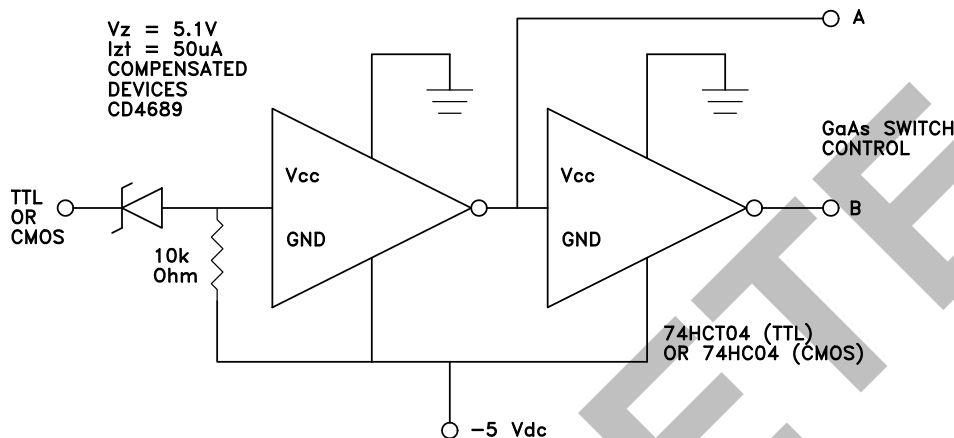

### Pin Descriptions

Pin Number	Function	Description	Interface Schematic
1, 3	A, B	See truth table and control voltage table.	
2, 5, 8	RFC, RF1, RF2	These pins are DC coupled and matched to 50 Ohm. Blocking capacitors are required if RF line potential is not equal to 0V.	
4, 6, 7	GND	Package bottom must also be connected to PCB RF ground.	

**GaAs MMIC HIGH ISOLATION SMT  
SPDT SWITCH, DC - 6 GHz**

**Evaluation PCB**

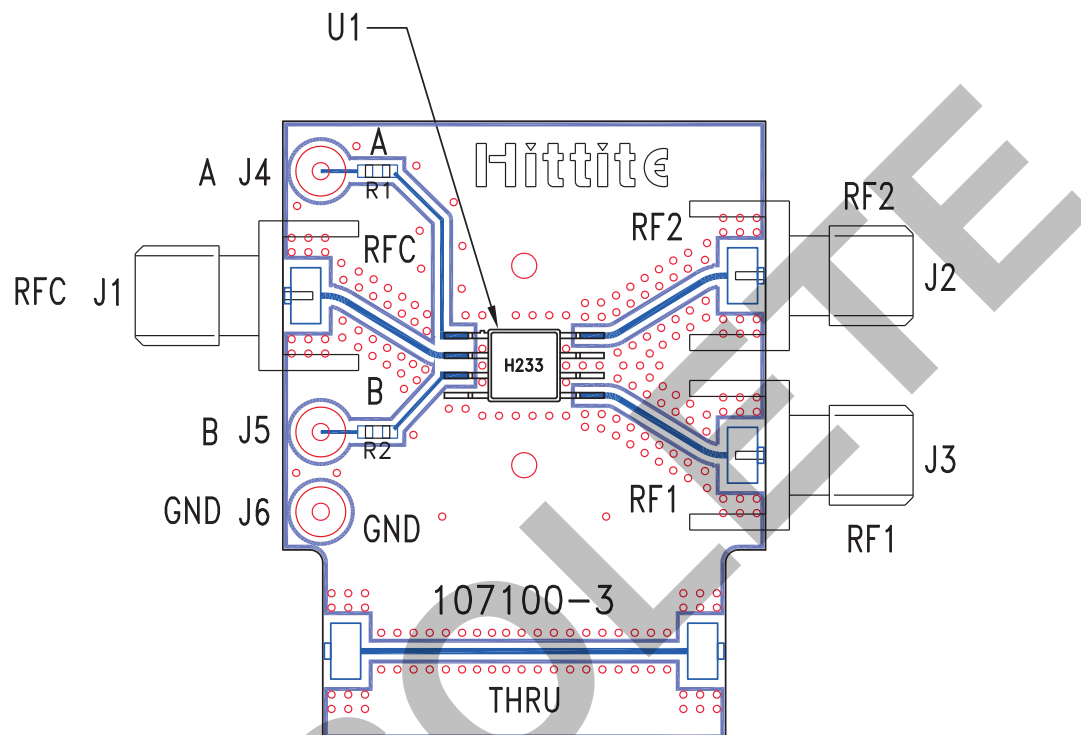

10

SWITCHES - SMT

**List of Materials for Evaluation PCB 107183 [1]**

Item	Description
J1 - J3	PCB Mount SMA RF Connector
J4 - J6	DC Pin
R1, R2	100 Ohm Resistor, 0603 Pkg.
U1	HMC233G8 SPDT Switch
PCB [2]	107100 Evaluation PCB

[1] Reference this number when ordering complete evaluation PCB

[2] Circuit Board Material: Rogers 4350

The circuit board used in the final application should be generated with proper RF circuit design techniques. Signal lines at the RF port should have 50 ohm impedance and the package ground leads and package bottom should be connected directly to the ground plane similar to that shown above. The evaluation circuit board shown above is available from Hittite Microwave Corporation upon request.

**GaAs MMIC HIGH ISOLATION SMT  
SPDT SWITCH, DC - 6 GHz****Notes:**

OBSOLETE