

Pushbutton Switches, 30mm, Round or Mushroom Buttons

FLUSH GUARD MOMENTARY

Metal Bushing

Contact blocks not supplied, order separately. (See page I8.)

Model	Special Details
M6010(*)	Momentary

(*) Specify color by adding suffix number:
(0) Black, (2) Red, (4) Yellow, (5) Green, (6) Blue, (9) White.

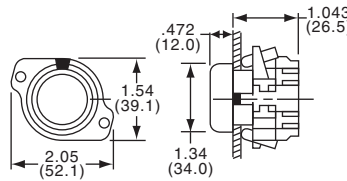

M6010(*)

EXTENDED BUTTON MOMENTARY

Metal Bushing

Contact blocks not supplied, order separately. (See page I8.)

Model	Special Details
M6020(*)	Momentary

(*) Specify color by adding suffix number:
(0) Black, (2) Red, (4) Yellow, (5) Green, (6) Blue, (9) White.

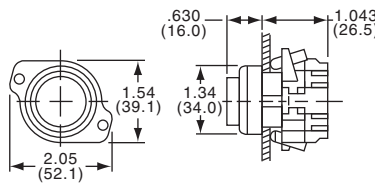

M6020(*)

MUSHROOM HEAD MOMENTARY PUSH MAINTAINED

Metal Bushing

Contact blocks not supplied, order separately. (See page I8.)

Tyco Electronics	Alcoswitch	Special Details	Color
—	M6057(*)	Momentary	(*)
1437610-6	M60532	Push-Pull	Red
1-1437610-3	M60652	Push-Lock/Twist To Release	Red

(*) Specify color by adding suffix number:
(0) Black, (2) Red, (3) Orange, (4) Yellow, (5) Green, (6) Blue, (9) White.

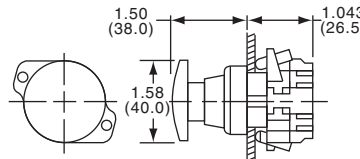

M6057(*)

LARGE MUSHROOM HEAD MOMENTARY PUSH

Metal Bushing

Contact blocks not supplied, order separately. (See page I8.)

Tyco Electronics	Alcoswitch	Special Details	Color
1-1437610-2	M60582	Momentary	Red

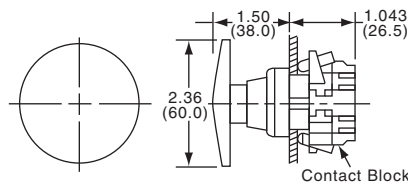

M60582

LARGE GUARDED MUSHROOM HEAD MOMENTARY PUSH

Metal Bushing. Heavy duty metal bushing and guard.
Contact blocks not supplied, order separately. (See page I8.)

Model	Special Details
M6080(*)	Momentary

(*) Specify color by adding suffix number: (0) Black, (2) Red, (5) Green.

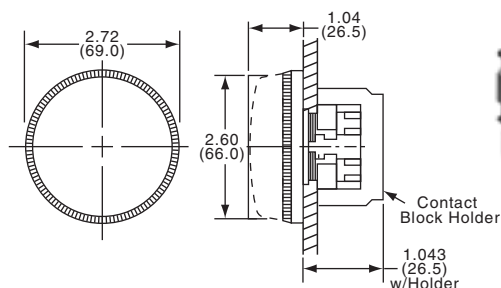

M6080(*)

Selector Switches or Joysticks, 30mm

5-POSITION JOYSTICK (4 Active & Center-Off)



M65510

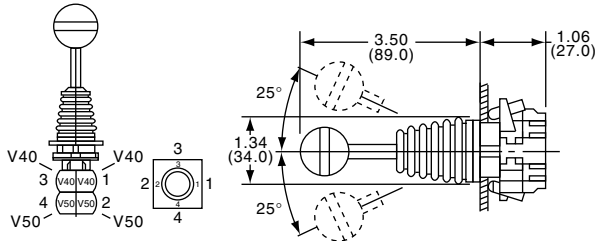

Metal Bushing

Maintained or momentary model with or without mechanical latch. Inherent design requires use of N.O. and N.C. Contact blocks not supplied, order separately. (See page I8.) Supplied with legend plate (1-2-3-4), black knob.

CONTACT ARRANGEMENT

Contact blocks should be placed as shown. All contacts are held open in neutral position. Each number contact closed when activated. Model M65310 has only two active positions, requires one N.O. and one N.C. contact block.

Note: All positions are mutually exclusive and action must pass through neutral for all changes of operator level.

Tyco Electronics	Alcoswitch	Action					
3-1437610-5	M65310	Momentary, No Latch	(On)	Off	(On)		
—	M65500	Maintained, No Latch	On	On	Off	On	On
3-1437610-6	M65510	Momentary, No Latch	(On)	(On)	Off	(On)	(On)
3-1437610-7	M65810	Momentary w/Latch	(On)	(On)	Off	(On)	(On)

(On) indicates momentary position.

2-POSITION SELECTOR MAINTAINED



M6402(*)

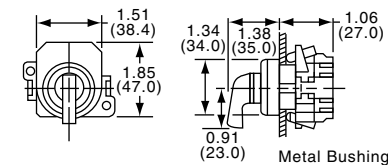

Metal Bushing

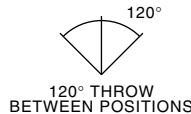
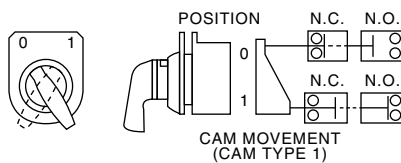

Metal Bushing

Contact blocks not supplied, order separately. (See page I8.) Legend plant included.

Model	Action	Lever	Position Number
M6402(*)	Maintained	Long	0 1

(*) Specify color by adding suffix number: (0) Black, (2) Red.

3-POSITION SELECTOR MAINTAINED OR MOMENTARY



M6412(*)

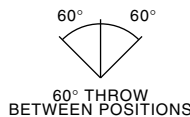
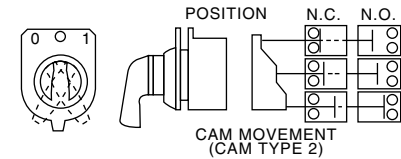
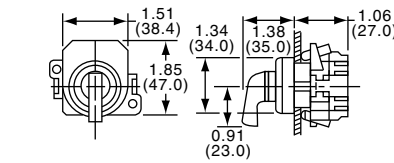

Metal Bushing

Contact blocks not supplied, order separately. (See page I8.) Legend plate included.

Model	Action	Lever	Cam	Position Number
M6410(*)	Maintained	Long	2	2 0 1
M6412(*)	Maintained	Long	3	2 0 1
M6470(*)	Mom. 1 Side	Long	2	2 0 ← 1
M6480(*)	Mom. 2 Sides	Long	2	2 → 0 ← 1

Indicates momentary return position

(*) Specify color by adding suffix number: (0) Black, (2) Red.

Keylock or Pushbutton Switches, 30mm

**2 POSITION KEY SELECTOR
MAINTAINED OR MOMENTARY**

Metal Bushing
Supplied with two keys and legend plate.
Contact blocks not supplied, order separately.
(See page I8)

Tyco Electronics	Alcoswitch	Action	Cam	Position Number	Throw	Remove Key	
2-1437610-2	M6200	Maintained	1	0 1	60°	⊙	
2-1437610-3	M6201	Maintained	1	0 1	60°	⊗	
2-1437610-6	M6250	Momentary	1	0 ← 1	60°	⊙	
1437617-1	G001	Additional Keys					⊙

← Indicates momentary return position

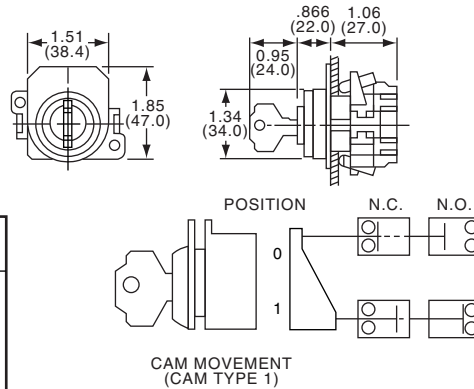

M62000

**3 POSITION KEY SELECTOR
MAINTAINED OR MOMENTARY**

Metal Bushing
Supplied with two keys and legend plate.
Contact blocks not supplied, order separately.
(See page I8.)

Tyco Electronics	Alcoswitch	Action	Cam	Position Number	Remove Key	
2-1437610-5	M6210	Maintained	2	2 0 1	⊙	
2-1437610-7	M6270	Mom. 1 Side	2	2 0 ← 1	⊗	
2-1437610-8	M6280	Mom. 2 Sides	2	2 → 0 ← 1	⊙	
1437617-1	G001	Additional Keys				

← Indicates momentary return position

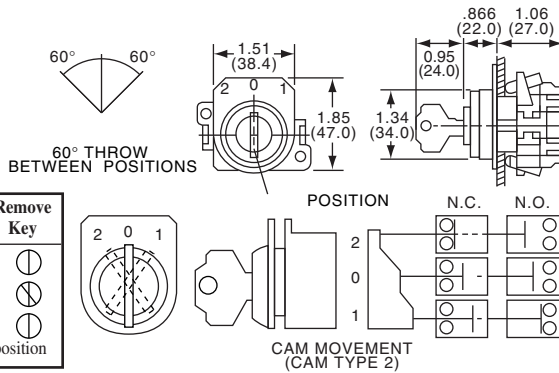

M62700

ILLUMINATED EXTENDED BUTTON MOMENTARY

Metal Bushing
Lamp not supplied, order separately. (See page I15.) Uses T31/4 miniature bayonet base lamps. Lamp circuit is isolated. Contact blocks not supplied, order separately. (See page I8)

Model	Special Details
M6120(*)406	Momentary

(*) Specify color by adding suffix number: (2) Red, (4) Yellow, (5) Green, (9) White.

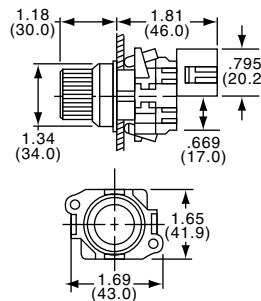

M6120(*)406

**ILLUMINATED MUSHROOM
MAINTAINED OR MOMENTARY**

Metal Bushing
Lamp not supplied, order separately. (See page I15.)
Uses miniature bayonet base lamps. Lamp circuit is isolated.
Contact block not supplied, order separately. (See page I8.)

Model	Special Details
M6150(*)406	Momentary
M6153(*)406	Maintained, Push-Pull

(*) Specify color by adding suffix number: (2) Red, (4) Yellow, (5) Green, (9) White.

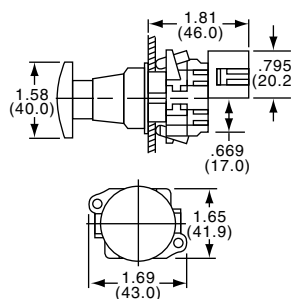

M6150(*)406

Selector Switches, 30mm, Illuminated



M6650(*)06

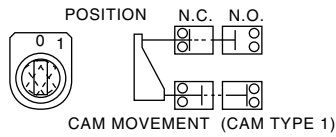
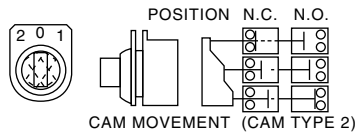
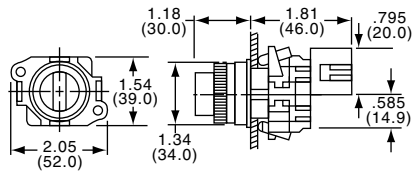

**ILLUMINATED MAINTAINED
SELECTOR**

Metal Bushing

Lamp not supplied, order separately. (See page I15.)

G31/2 lamps. Lamp circuit is isolated. Contact blocks not supplied, order separately. (See page I8.)

Model	Number Position	Action	Position Number		
M6653(*)406	3	Maintained	2	0	1
M6650(*)406	2	Maintained	0	1	

(*) Specify color by adding suffix number: (2) Red, (4) Yellow, (5) Green.

Model	Action	2-Position Operator		3-Position Operator		
V40 or F40	N.C.	O	1	1	O	2
V50 or F50	N.O.	X	O	X	O	O
VA0 or FA0	N.O. Early	O	X	O	X	X
VR0 or FR0	N.C. Make Break	X	O	X	X	0

O=Open
X = Closed

KEY TO SELECTION OF CONTACT BLOCKS
Contact closure variations depend on the contact block models chosen. For these operators listed use this table for guidance in selecting blocks.

Lamps/Transformers

LAMPS

The lamps with G31/2 bulbs fit all Reliant 22, Series 6000 illuminated operators and pilot lights. Lamps with T31/4 Bayonet Base fit all Reliant 22 and Series 6000 illuminated models (except QM120, QM122, and M6650, and M6655).

Tyco Electronics	Alcoswitch	Bulb	Rated Volts	Design Amps	MSCP	Average Rated Hours
1-1437620-5	755	T31/4	6.3	.15	.33	20,000
1-1437620-6	757	T31/4	28	.08	.62	7,500

*Not recommended for use with green or blue lenses.



NE51HR

755

Application Note: For additional specifications, see page K10

STEP-DOWN TRANSFORMERS

AC LINE TO 6V/6.3V

Snap mount on lighted operators and QM600, T6632 and RM600 pilot lights. Spade tipped leads connect to lamp terminals on operator. Screw terminals on primary. Use 6-6.3V lamps. 0-9 to 1.35 watts. Secondary winding is energy-limited.

Tyco Electronics	Alcoswitch	Primary Voltage
1437612-8	5B0	110-120 VAC
1437612-7	570	220-240 VAC

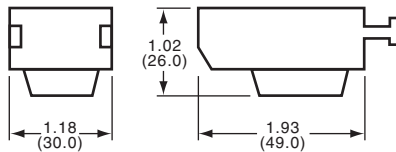

U.L. Recognized

5B0

Panel Layouts

RELIANT'22 MINIATURE MODELS

Recommended hole mounting dimensions*

Minimum Center-To-Center Spacing
Inches/(mm)

Operator Type	A	B
Pushbuttons, Pilots	1.19/30.2	1.66/42.2
Mushroom, Selector	1.50/37.8	1.66/42.2
Others	1.94/49.3	1.94/49.3

*Check dimensions for layouts using legend plates.

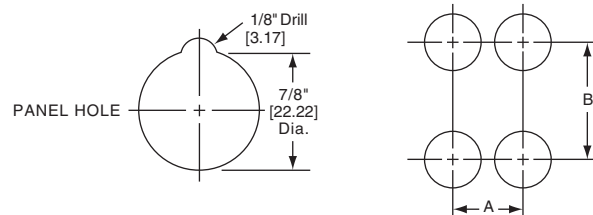

SERIES 6000 STANDARD MODELS

Recommended hole mounting dimensions*

Minimum Center-To-Center Spacing
Inches/(mm)

Operator Type	A	B
Pushbuttons, Pilots	1.88/47.8	1.97/50.0
Mushroom, Selector	2.25/57.2	2.25/57.2
Large Mushroom	3.00/76.2	3.00/76.2

*Check dimensions for layouts using legend plates.

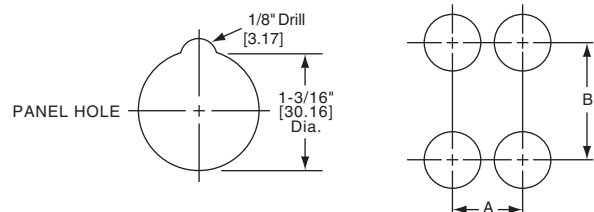

Series 6000