

12V, 6A High-Efficiency Buck Regulator with Hyper Speed Control®

Features

- Hyper Speed Control® Architecture Enables:
 - High Delta V Operation ($V_{IN} = 19V$ and $V_{OUT} = 0.8V$)
 - Small Output Capacitance
- 4.5V to 19V Voltage Input
- 6A Output Current Capability, up to 95% Efficiency
- Adjustable Output from 0.8V to 5.5V
- $\pm 1\%$ Feedback Accuracy
- Any Capacitor Stable - Zero-to-High ESR
- 600 kHz Switching Frequency
- No External Compensation
- Power Good (PG) Output
- Foldback Current-Limit and “Hiccup Mode” Short-Circuit Protection
- Supports Safe Start-Up into a Pre-Biased Load
- $-40^{\circ}C$ to $+125^{\circ}C$ Junction Temperature Range
- Available in a 28-pin 5 mm x 6 mm QFN Package

Applications

- Servers and Workstations
- Routers, Switches, and Telecom Equipment
- Base Stations

General Description

The MIC24051 is a constant-frequency, synchronous buck regulator featuring a unique adaptive on-time control architecture. The MIC24051 operates over an input supply range of 4.5V to 19V and provides a regulated output of up to 6A of output current. The output voltage is adjustable down to 0.8V with a guaranteed accuracy of $\pm 1\%$, and the device operates at a switching frequency of 600 kHz.

Microchip's Hyper Speed Control® architecture allows for ultra-fast transient response while reducing the output capacitance and also makes (High V_{IN})/(Low V_{OUT}) operation possible. This adaptive t_{ON} ripple control architecture combines the advantages of fixed-frequency operation and fast transient response in a single device.

The MIC24051 offers a full suite of protection features to ensure protection of the IC during fault conditions. These include undervoltage lockout to ensure proper operation under power-sag conditions, internal soft-start to reduce inrush current, foldback current limit, “hiccup mode” short-circuit protection and thermal shutdown. An open-drain Power Good (PG) pin is provided.

The 6A HyperLight Load® part, MIC24052, is also available on Microchip's web site.

Typical Application Schematic

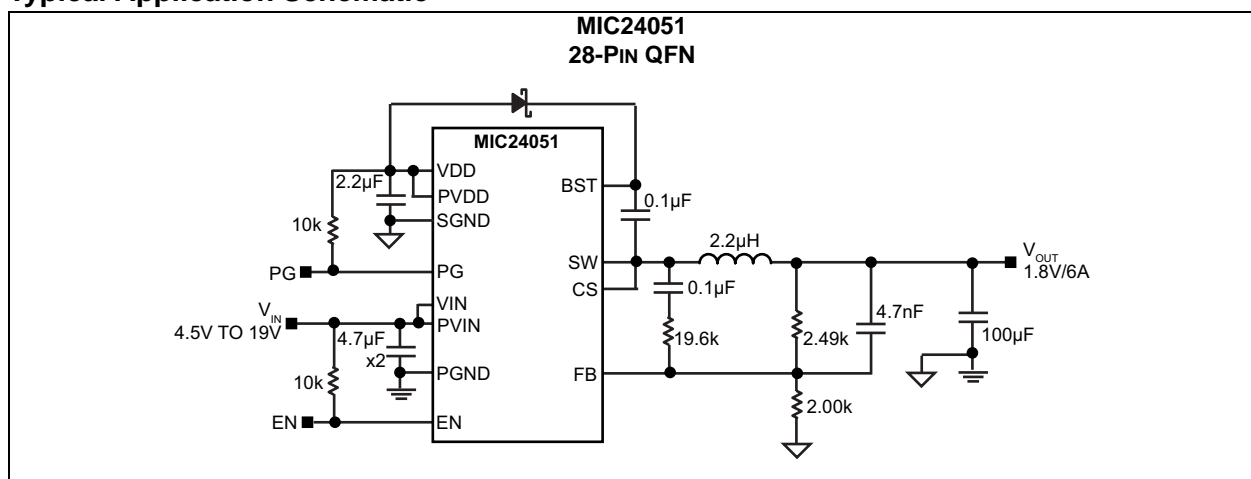

MIC24051

Package Type

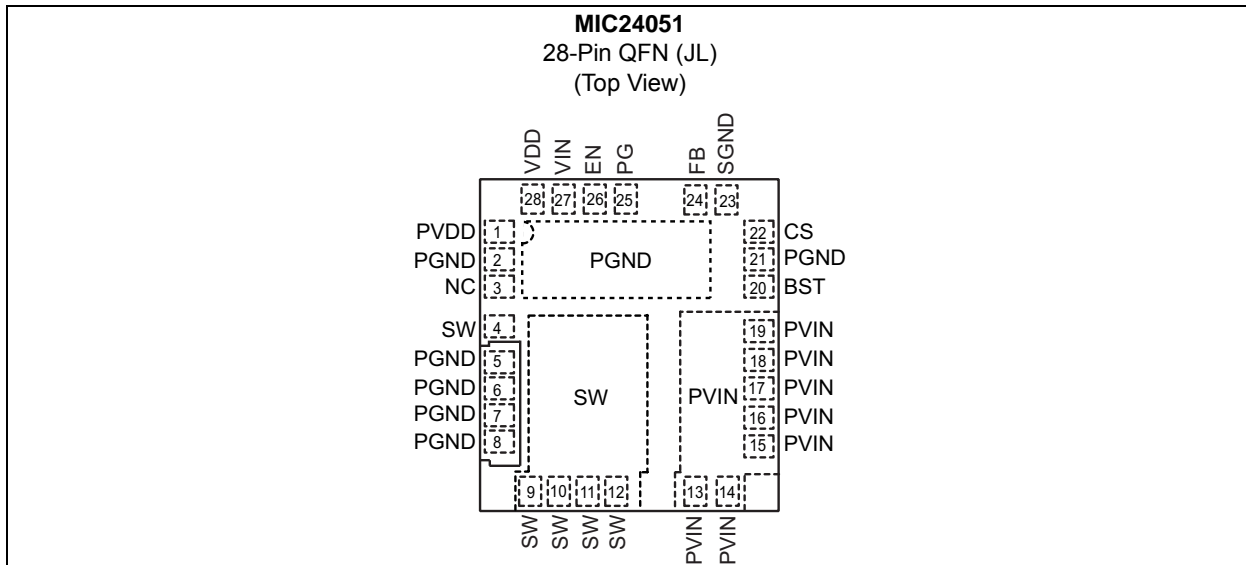

Block Diagram

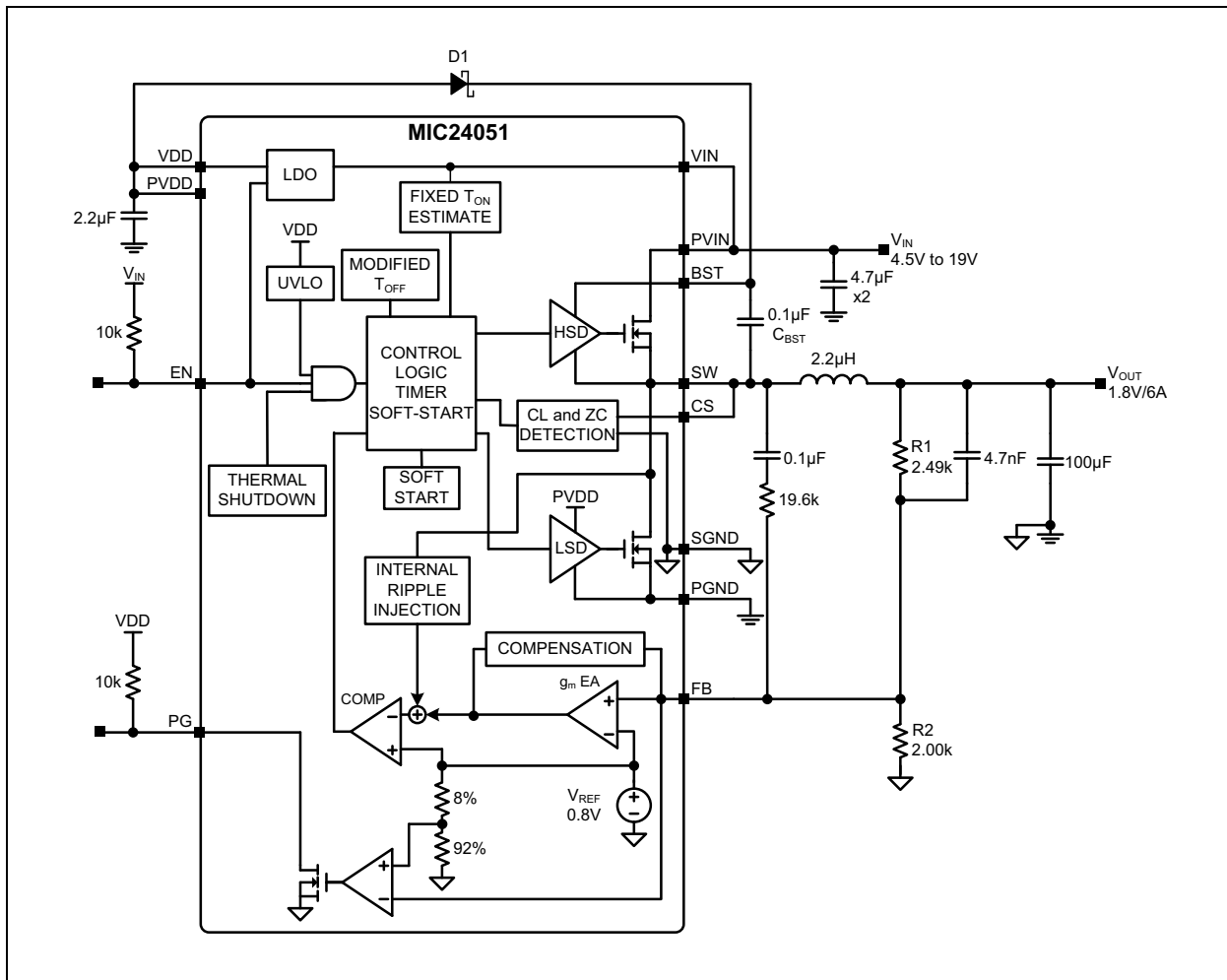

1.0 ELECTRICAL CHARACTERISTICS

Absolute Maximum Ratings †

PV_{IN} to PGND	-0.3V to +29V
V_{IN} to PGND	-0.3V to PV_{IN}
PV_{DD} , V_{DD} to PGND	-0.3V to +6V
V_{SW} , V_{CS} to PGND	-0.3V to ($PV_{IN} + 0.3V$)
V_{BST} to V_{SW}	-0.3V to +6V
V_{BST} to PGND	-0.3V to +35V
V_{FB} , V_{PG} to PGND	-0.3V to ($V_{DD} + 0.3V$)
V_{EN} to PGND	-0.3V to ($V_{IN} + 0.3V$)
PGND to SGND	-0.3V to +0.3V
ESD Rating (Note 1)	ESD Sensitive

Operating Ratings ‡

Supply Voltage (PV_{IN} , V_{IN})	+4.5V to +19V
PV_{DD} , V_{DD} Supply Voltage (PV_{DD} , V_{DD})	+4.5V to +5.5V
Enable Input (V_{EN})	0V to V_{IN}

† **Notice:** Stresses above those listed under “Absolute Maximum Ratings” may cause permanent damage to the device. This is a stress rating only and functional operation of the device at those or any other conditions above those indicated in the operational sections of this specification is not intended. Exposure to maximum rating conditions for extended periods may affect device reliability.

‡ **Notice:** The device is not guaranteed to function outside its operating ratings.

Note 1: Devices are ESD sensitive. Handling precautions recommended. Human body model, 1.5 k Ω in series with 100 pF.

MIC24051

TABLE 1-1: ELECTRICAL CHARACTERISTICS

Electrical Characteristics: $PV_{IN} = V_{IN} = V_{EN} = 12V$, $V_{BST} - V_{SW} = 5V$; $T_A = 25^\circ C$, unless noted. Bold values indicate $-40^\circ C \leq T_J \leq +125^\circ C$. (Note 1).						
Parameters	Sym.	Min.	Typ.	Max.	Units	Conditions
Power Supply Input						
Input Voltage Range (V_{IN} , PV_{IN})	—	4.5	—	19	V	—
Quiescent Supply Current	—	—	730	1500	μA	$V_{FB} = 1.5V$ (non-switching)
Shutdown Supply Current	—	—	5	10	μA	$V_{EN} = 0V$
V_{DD} Supply Voltage						
V_{DD} Output Voltage	—	4.8	5	5.4	V	$V_{IN} = 7V$ to $19V$, $I_{DD} = 40$ mA
V_{DD} UVLO Threshold	—	3.7	4.2	4.5	V	V_{DD} Rising
V_{DD} UVLO Hysteresis	—	—	400	—	mV	—
Dropout Voltage ($V_{IN} - V_{DD}$)	—	—	380	600	mV	$I_{DD} = 25$ mA
DC/DC Controller						
Output-Voltage Adjust Range (V_{OUT})	—	0.8	—	5.5	V	—
Reference						
Feedback Reference Voltage	—	0.792	0.8	0.808	V	$0^\circ C \leq T_J \leq +85^\circ C$ ($\pm 1.0\%$)
	—	0.788	0.8	0.812	V	$-40^\circ C \leq T_J \leq +125^\circ C$ ($\pm 1.5\%$)
Load Regulation	—	—	0.25	—	%	$I_{OUT} = 0A$ to $6A$ (Continuous Mode)
Line Regulation	—	—	0.25	—	%	$V_{IN} = 4.5V$ to $19V$
FB Bias Current	—	—	50	500	nA	$V_{FB} = 0.8V$
Enable Control						
EN Logic Level High	—	1.8	—	—	V	—
EN Logic Level Low	—	—	—	0.6	V	—
EN Bias Current	—	—	6	30	μA	$V_{EN} = 12V$
Oscillator						
Switching Frequency (Note 2)	—	450	600	750	kHz	$V_{OUT} = 2.5V$
Maximum Duty Cycle (Note 3)	—	—	82	—	%	$V_{FB} = 0V$
Minimum Duty Cycle	—	—	0	—	%	$V_{FB} = 1.0V$
Minimum Off-Time	—	—	300	—	ns	—
Soft-Start						
Soft-Start Time	—	—	3	—	ms	—
Short-Circuit Protection						
Peak Inductor Current-Limit Threshold	—	7.5	11	17	A	$V_{FB} = 0.8V$, $T_J = 25^\circ C$
		6.6	11	17		$V_{FB} = 0.8V$, $T_J = 125^\circ C$
Short-Circuit Current	—	—	8	—	A	$V_{FB} = 0V$
Internal FETs						

Note 1: Specification for packaged product only.

2: Measured in test mode.

3: The maximum duty-cycle is limited by the fixed mandatory off-time (t_{OFF}) of typically 300 ns.

TABLE 1-1: ELECTRICAL CHARACTERISTICS (CONTINUED)

Electrical Characteristics: $PV_{IN} = V_{IN} = V_{EN} = 12V$, $V_{BST} - V_{SW} = 5V$; $T_A = 25^\circ C$, unless noted. Bold values indicate $-40^\circ C \leq T_J \leq +125^\circ C$. (Note 1).						
Parameters	Sym.	Min.	Typ.	Max.	Units	Conditions
Top MOSFET $R_{DS(ON)}$	—	—	42	—	m Ω	$I_{SW} = 1A$
Bottom MOSFET $R_{DS(ON)}$	—	—	12.5	—	m Ω	$I_{SW} = 1A$
SW Leakage Current	—	—	—	60	μA	$V_{EN} = 0V$
V_{IN} Leakage Current	—	—	—	25	μA	$V_{EN} = 0V$
Power Good (PG)						
PG Threshold Voltage	—	85	92	95	% V_{OUT}	Sweep V_{FB} from Low to High
PG Hysteresis	—	—	5.5	—	% V_{OUT}	Sweep V_{FB} from High to Low
PG Delay Time	—	—	100	—	μs	Sweep V_{FB} from Low to High
PG Low Voltage	—	—	70	200	mV	Sweep $V_{FB} < 0.9 \times V_{NOM}$, $I_{PG} = 1 mA$
Thermal Protection						
Overtemperature Shutdown	—	—	160	—	$^\circ C$	T_J Rising
Overtemperature Shutdown Hysteresis	—	—	15	—	$^\circ C$	—

Note 1: Specification for packaged product only.

2: Measured in test mode.

3: The maximum duty-cycle is limited by the fixed mandatory off-time (t_{OFF}) of typically 300 ns.

MIC24051

TEMPERATURE SPECIFICATIONS

Parameters	Sym.	Min.	Typ.	Max.	Units	Conditions
Temperature Ranges						
Junction Operating Temperature Range	T_J	-40	—	+125	°C	Note 1
Maximum Junction Temperature	—	—	—	+150	°C	—
Storage Temperature	T_S	-65	—	+150	°C	—
Lead Temperature	—	—	—	+260	°C	Soldering, 10s
Package Thermal Resistances						
Thermal Resistance, 5x6 QFN-28	θ_{JA}	—	28	—	°C/W	Note 2
Thermal Resistance, 5x6 QFN-28	θ_{JC}	—	2.5	—	°C/W	—

Note 1: The maximum allowable power dissipation is a function of ambient temperature, the maximum allowable junction temperature and the thermal resistance from junction to air (i.e., T_A , T_J , θ_{JA}). Exceeding the maximum allowable power dissipation will cause the device operating junction temperature to exceed the maximum +125°C rating. Sustained junction temperatures above +125°C can impact the device reliability.

2: $P_{D(MAX)} = (T_{J(MAX)} - T_A) / \theta_{JA}$, where θ_{JA} depends upon the printed circuit layout. A 5 square inch 4 layer, 0.62", FR-4 PCB with 2 oz. finish copper weight per layer is used for the θ_{JA} .

2.0 TYPICAL PERFORMANCE CURVES

Note: The graphs and tables provided following this note are a statistical summary based on a limited number of samples and are provided for informational purposes only. The performance characteristics listed herein are not tested or guaranteed. In some graphs or tables, the data presented may be outside the specified operating range (e.g., outside specified power supply range) and therefore outside the warranted range.

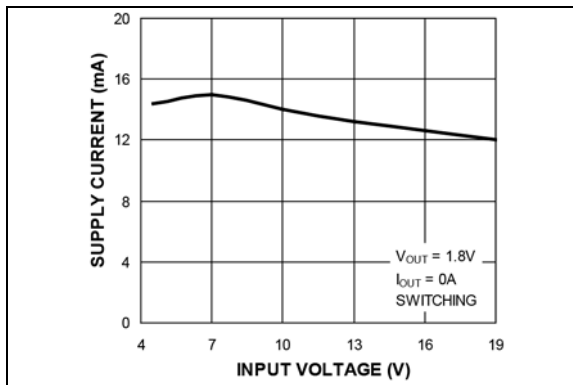

FIGURE 2-1: V_{IN} Operating Supply Current vs. Input Voltage.

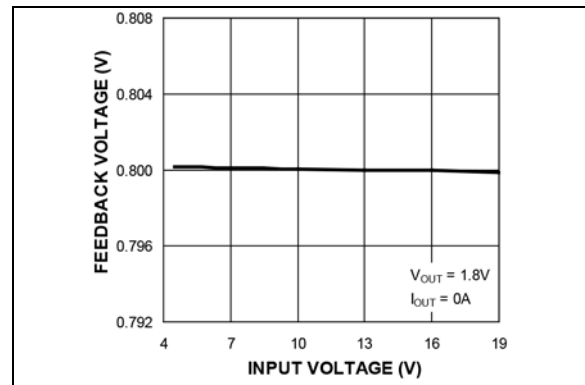

FIGURE 2-4: Feedback Voltage vs. Input Voltage.

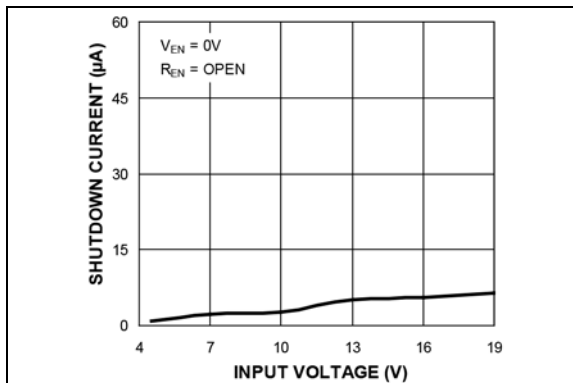

FIGURE 2-2: V_{IN} Shutdown Current vs. Input Voltage.

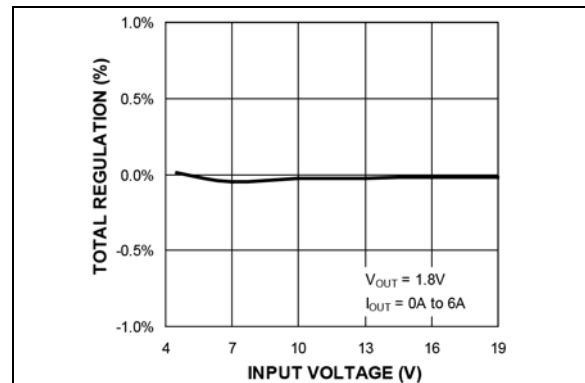

FIGURE 2-5: Total Regulation vs. Input Voltage.

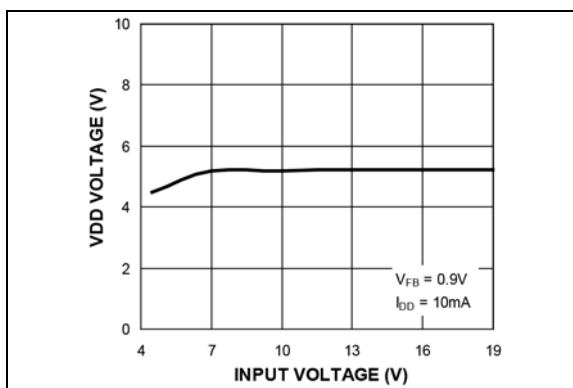

FIGURE 2-3: V_{DD} Output Voltage vs. Input Voltage.

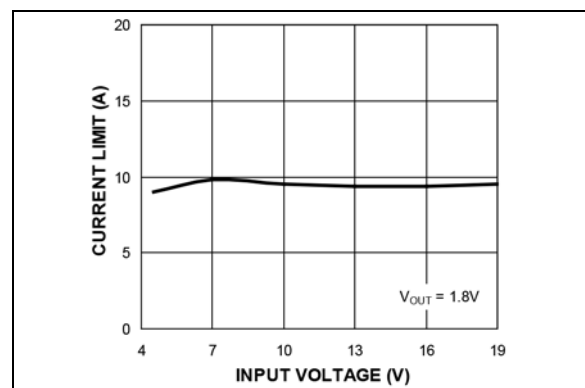

FIGURE 2-6: Output Current Limit vs. Input Voltage.

MIC24051

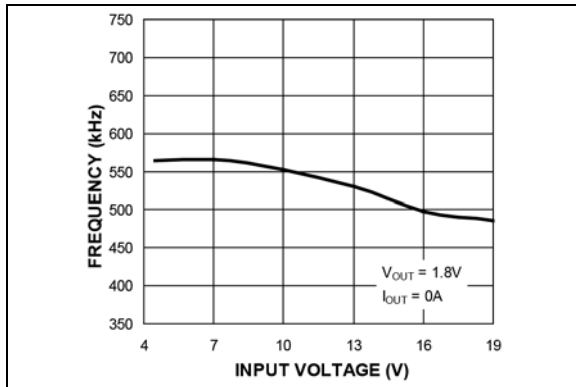

FIGURE 2-7: Switching Frequency vs. Input Voltage.

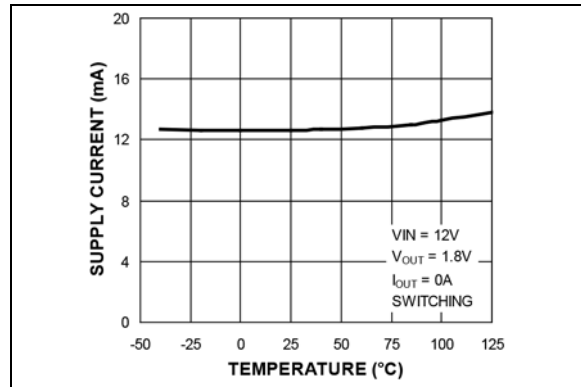

FIGURE 2-10: V_{IN} Operating Supply Current vs. Temperature.

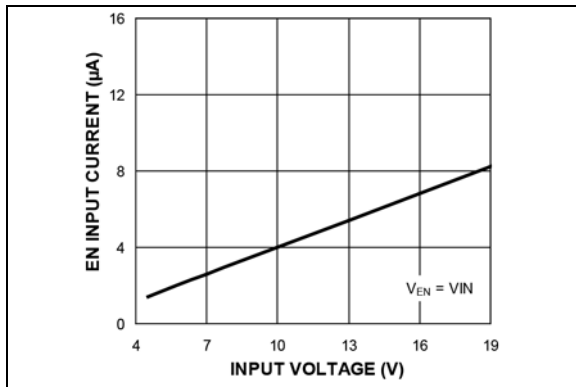

FIGURE 2-8: Enable Input Current vs. Input Voltage.

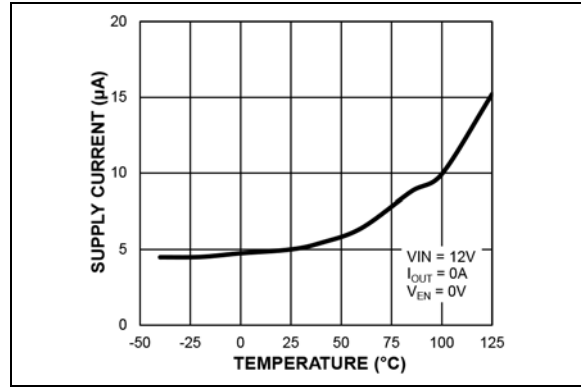

FIGURE 2-11: V_{IN} Shutdown Current vs. Temperature.

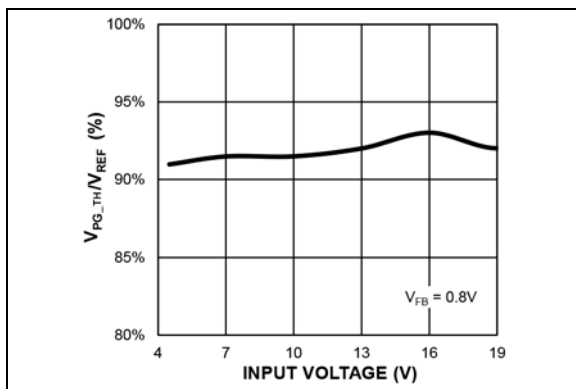

FIGURE 2-9: PG Threshold/ V_{REF} Ratio vs. Input Voltage.

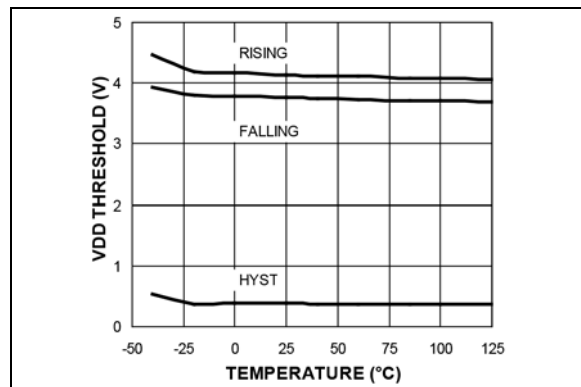

FIGURE 2-12: V_{DD} UVLO Threshold vs. Temperature.

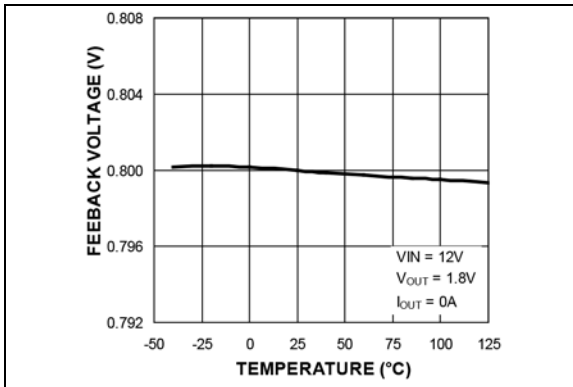

FIGURE 2-13: Feedback Voltage vs. Temperature.

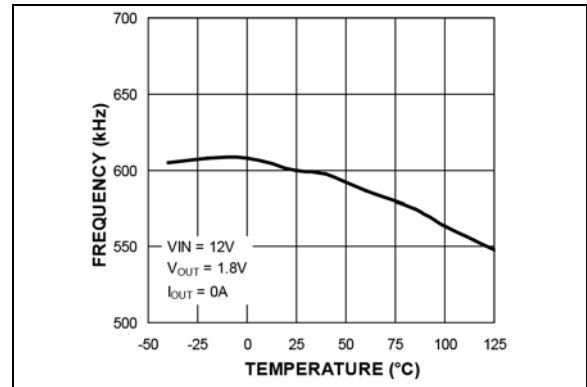

FIGURE 2-16: Switching Frequency vs. Temperature.

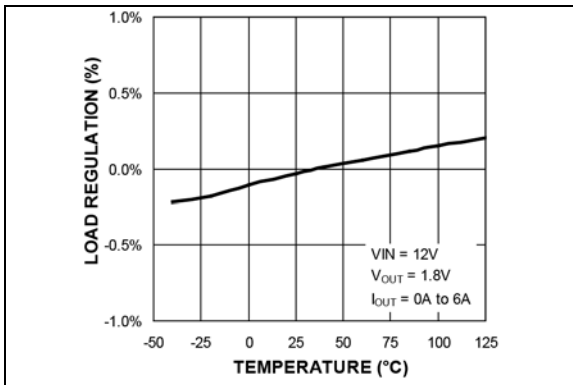

FIGURE 2-14: Load Regulation vs. Temperature.

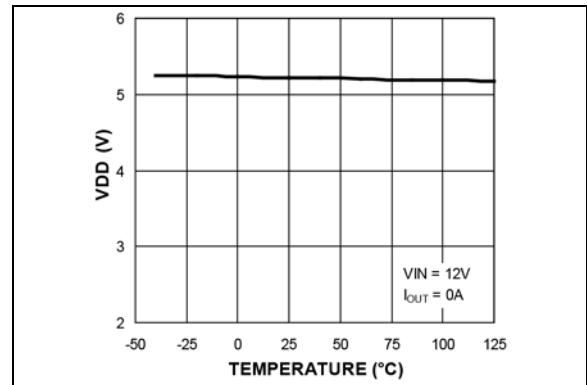

FIGURE 2-17: V_{DD} vs. Temperature.

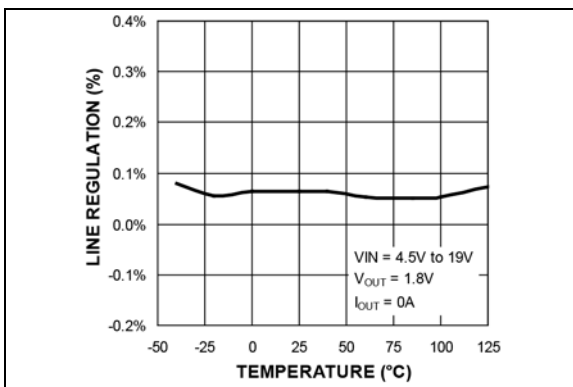

FIGURE 2-15: Line Regulation vs. Temperature.

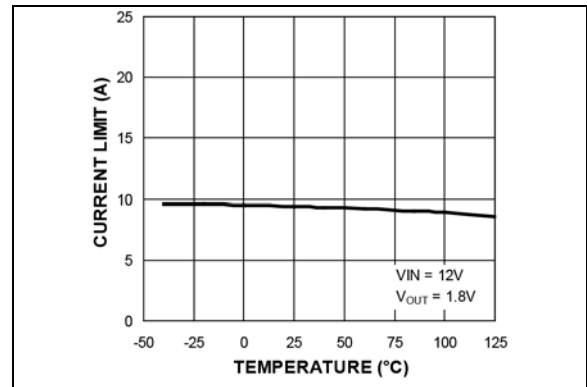

FIGURE 2-18: Output Current Limit vs. Temperature.

MIC24051

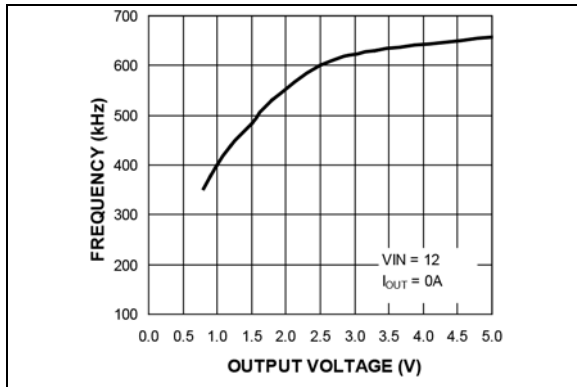

FIGURE 2-19: Switching Frequency vs. Output Voltage.

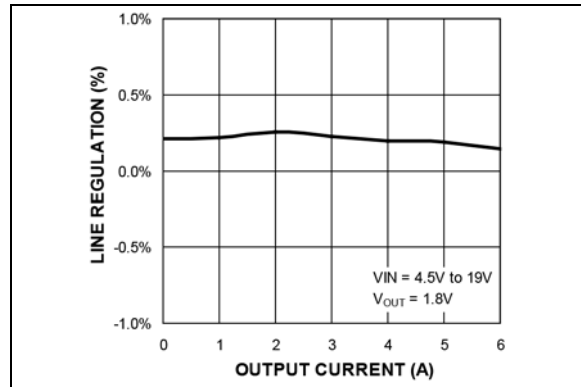

FIGURE 2-22: Line Regulation vs. Output Current.

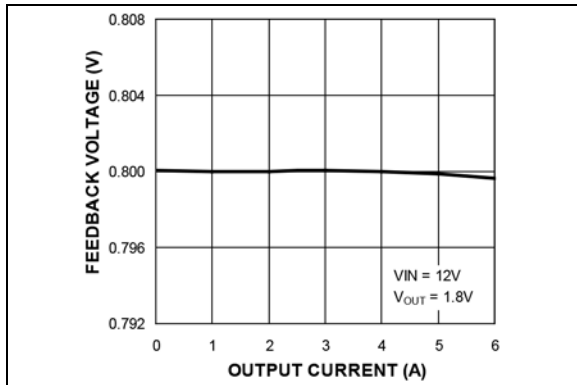

FIGURE 2-20: Feedback Voltage vs. Output Current.

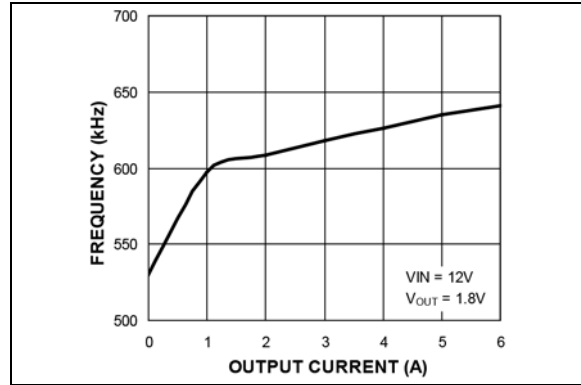

FIGURE 2-23: Switching Frequency vs. Output Current.

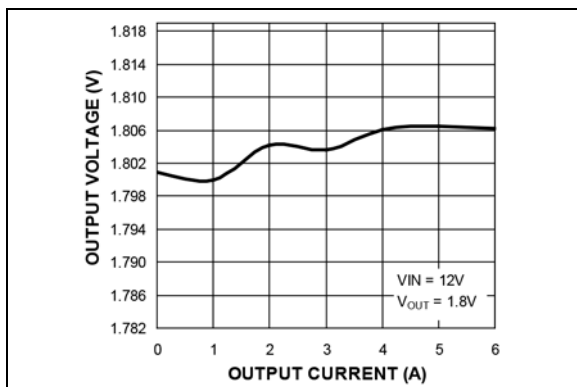

FIGURE 2-21: Output Voltage vs. Output Current.

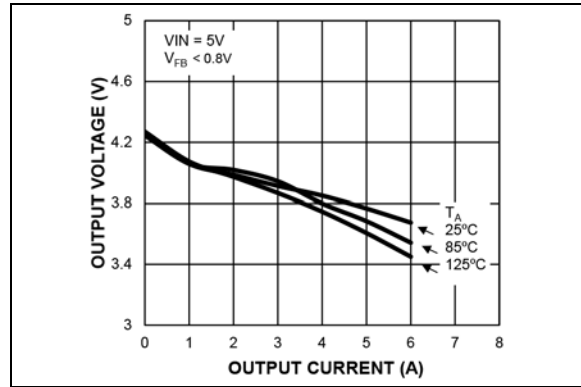

FIGURE 2-24: Output Voltage ($V_{IN} = 5V$) vs. Output Current.

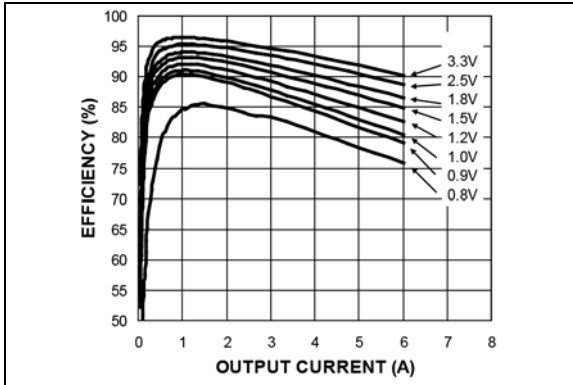

FIGURE 2-25: Efficiency ($V_{IN} = 5V$) vs. Output Current.

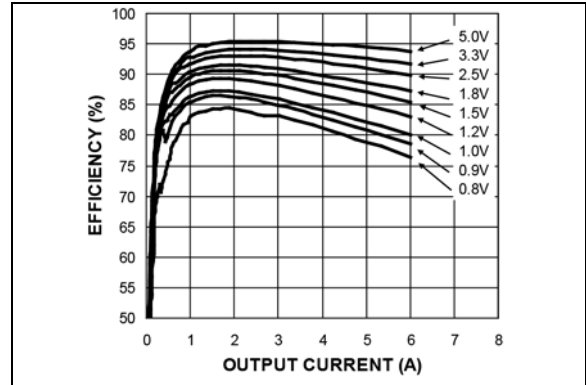

FIGURE 2-28: Efficiency ($V_{IN} = 12V$) vs. Output Current.

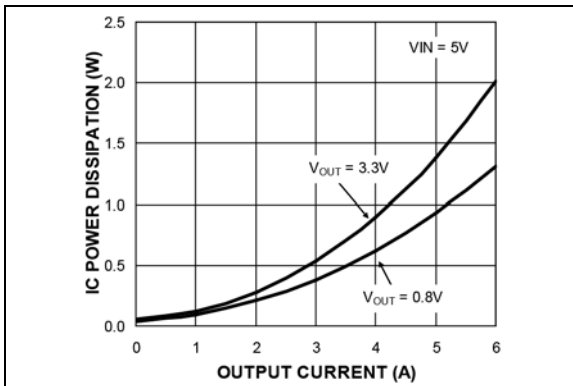

FIGURE 2-26: IC Power Dissipation ($V_{IN} = 5V$) vs. Output Current.

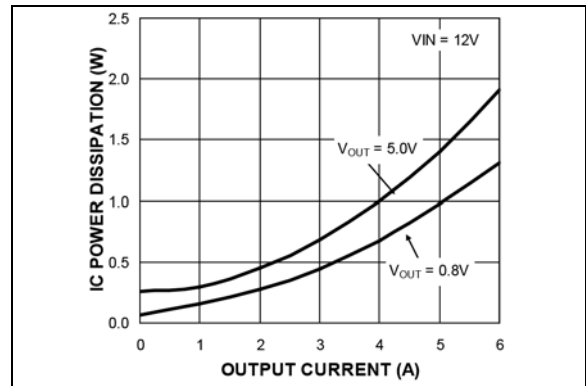

FIGURE 2-29: IC Power Dissipation ($V_{IN} = 12V$) vs. Output Current.

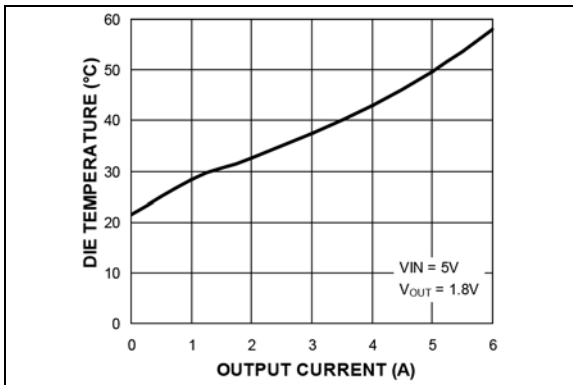

FIGURE 2-27: Die Temperature ($V_{IN} = 5V$) vs. Output Current (*Note 1*).

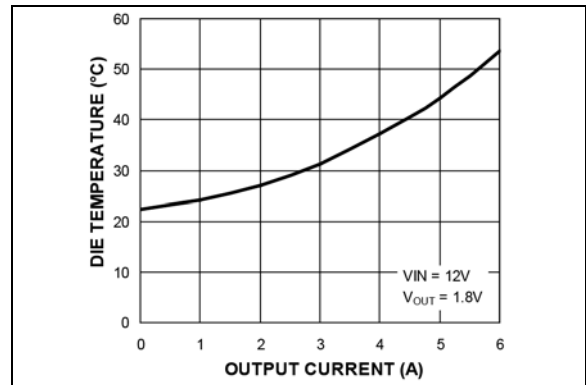

FIGURE 2-30: Die Temperature ($V_{IN} = 12V$) vs. Output Current (*Note 1*).

MIC24051

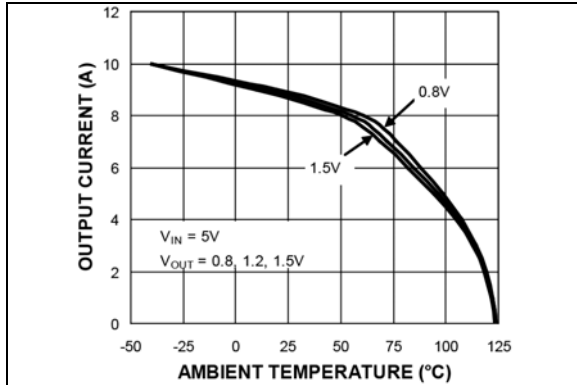

FIGURE 2-31: Thermal Derating vs. Ambient Temperature (Note 1).

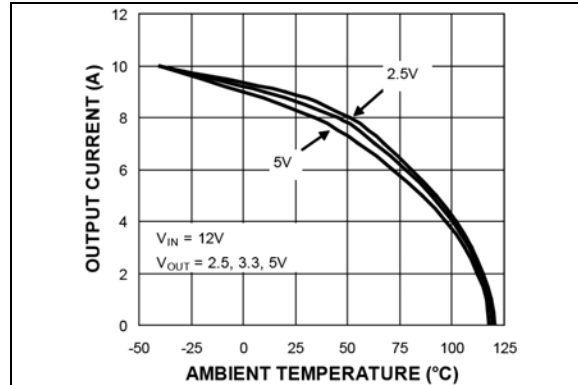

FIGURE 2-34: Thermal Derating vs. Ambient Temperature (Note 1).

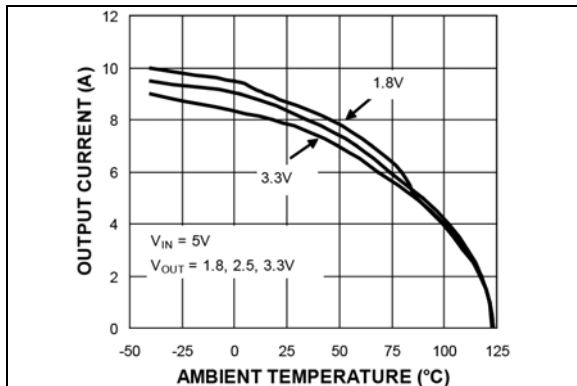

FIGURE 2-32: Thermal Derating vs. Ambient Temperature (Note 1).

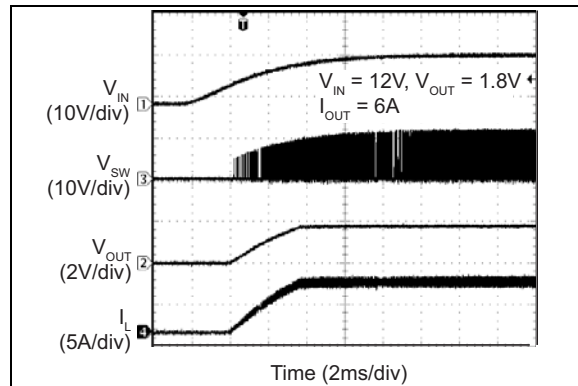

FIGURE 2-35: V_{IN} Soft Turn-On.

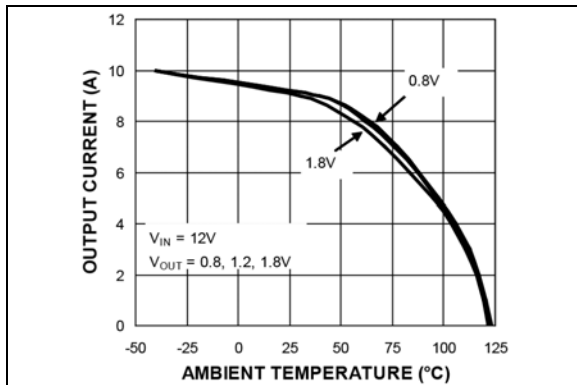

FIGURE 2-33: Thermal Derating vs. Ambient Temperature (Note 1).

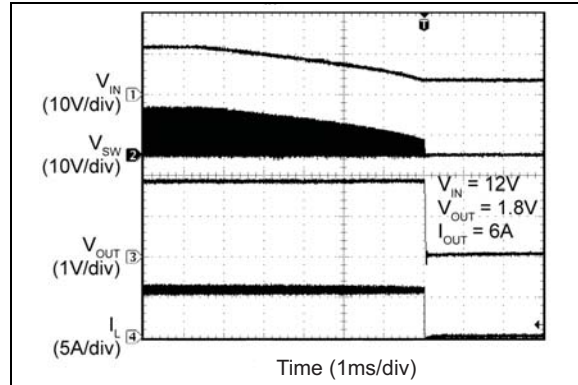

FIGURE 2-36: V_{IN} Soft Turn-Off.

Note 1: The temperature measurement was taken at the hottest point on the MIC24051 case mounted on a 5 square inch 4 layer, 0.62", FR-4 PCB with 2oz finish copper weight per layer, see Thermal Measurement section. Actual results will depend upon the size of the PCB, ambient temperature and proximity to other heat emitting components.

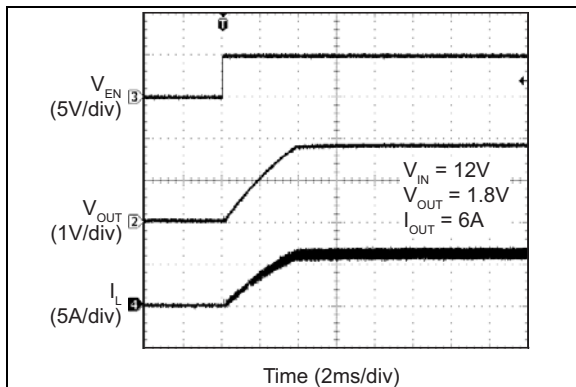

FIGURE 2-37: Enable Turn-On Delay and Rise Time.

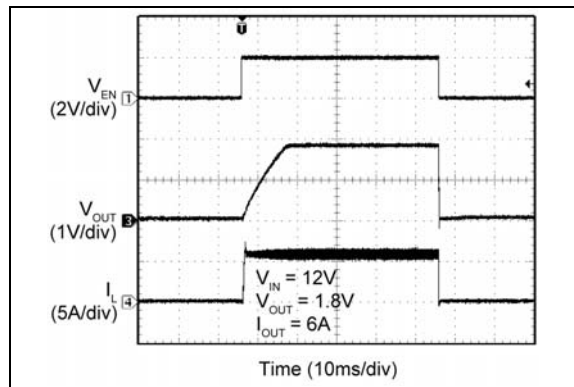

FIGURE 2-40: Enable Turn-On/Turn-Off.

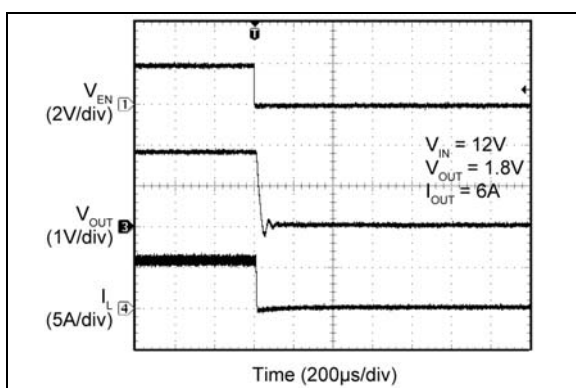

FIGURE 2-38: Enable Turn-Off Delay and Fall Time.

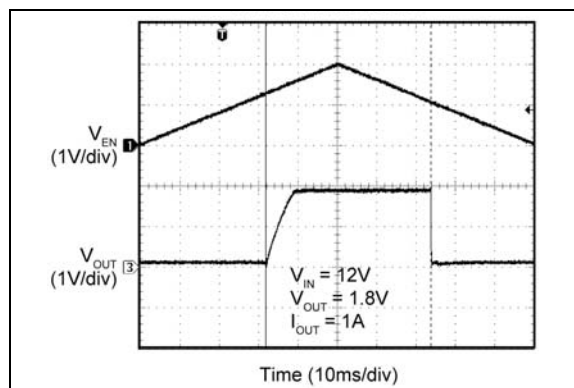

FIGURE 2-41: Enable Thresholds.

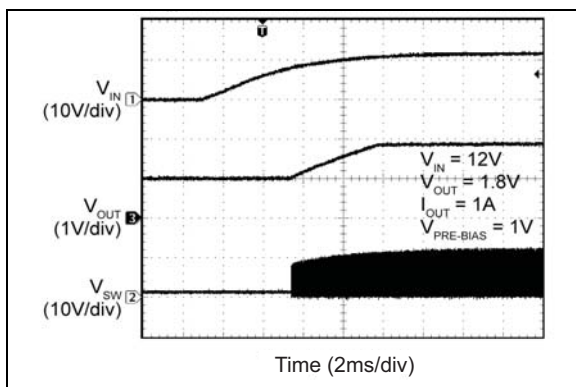

FIGURE 2-39: V_{IN} Start-Up with Pre-Biased Output.

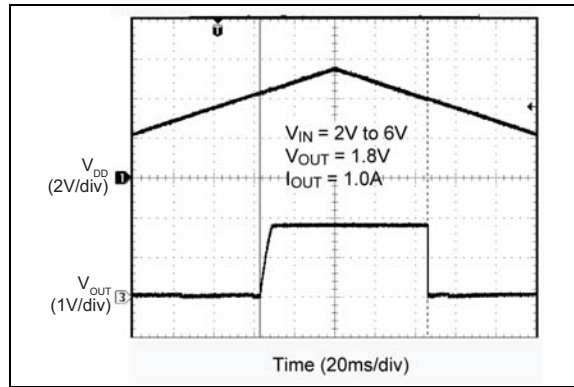

FIGURE 2-42: V_{DD} UVLO Thresholds.

MIC24051

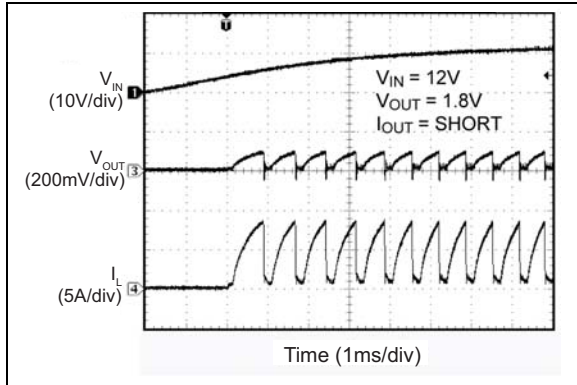

FIGURE 2-43: Power-Up Into Short Circuit.

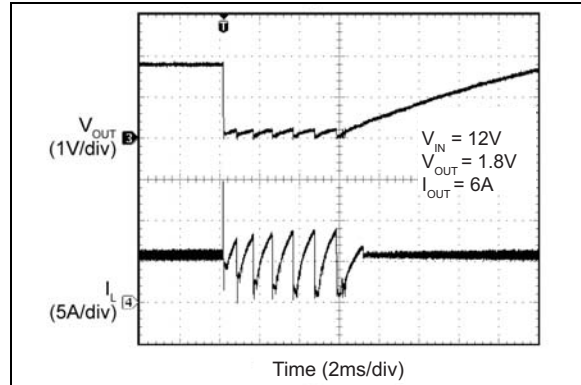

FIGURE 2-46: Output Recovery from Short Circuit.

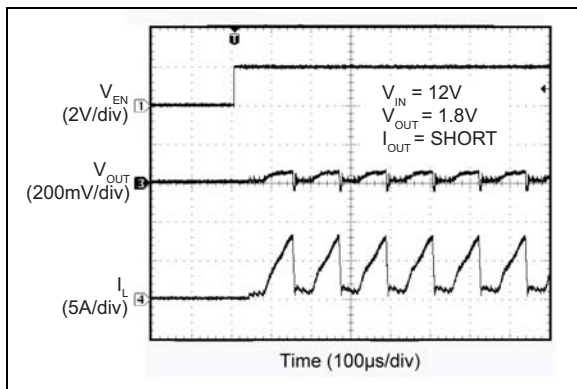

FIGURE 2-44: Enable Into Short Circuit.

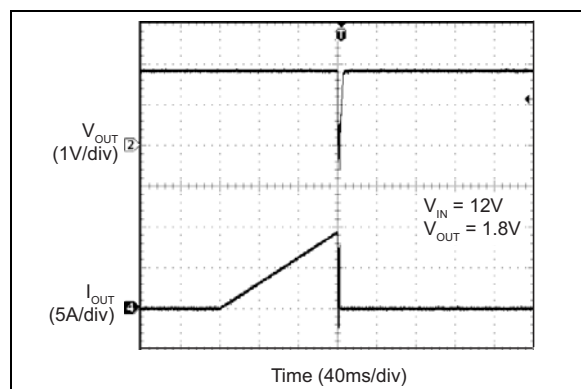

FIGURE 2-47: Output Current-Limit Threshold.

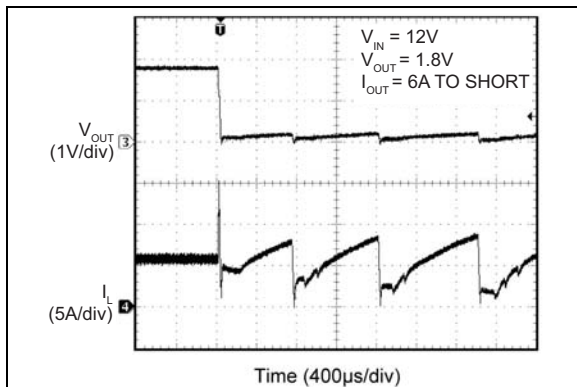

FIGURE 2-45: Short Circuit.

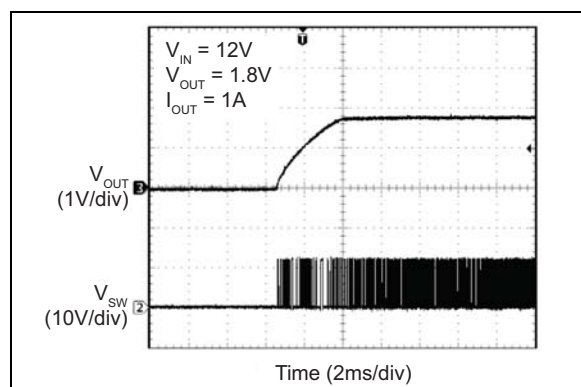

FIGURE 2-48: Output Recovery from Thermal Shutdown.

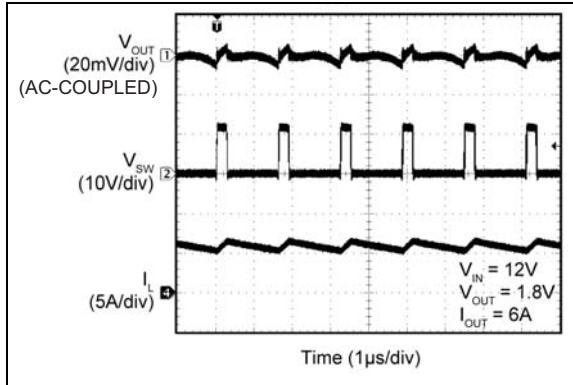

FIGURE 2-49: Switching Waveforms ($I_{OUT} = 6A$).

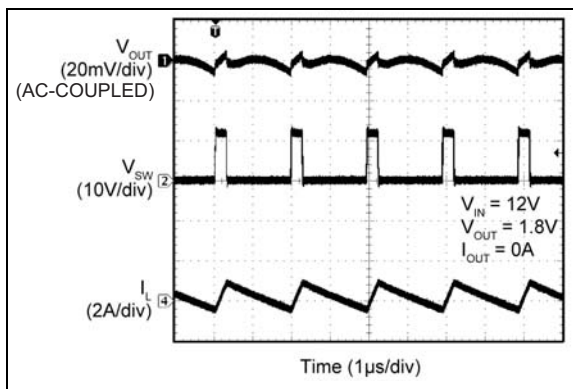

FIGURE 2-50: Switching Waveforms ($I_{OUT} = 0A$).

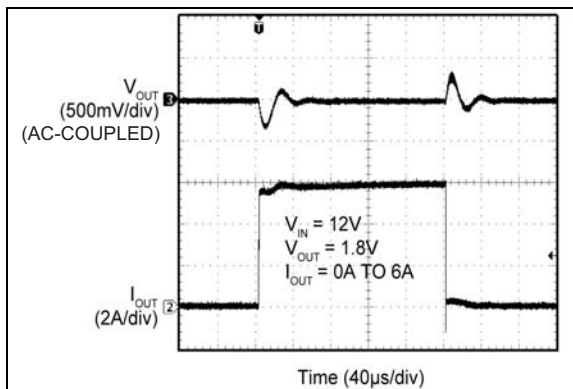

FIGURE 2-51: Transient Response.

MIC24051

3.0 PIN DESCRIPTIONS

The descriptions of the pins are listed in [Table 3-1](#).

TABLE 3-1: PIN FUNCTION TABLE

Pin Number	Pin Name	Description
1	PV _{DD}	5V Internal Linear Regulator output. PV _{DD} supply is the power MOSFET gate drive supply voltage and created by internal LDO from V _{IN} . When V _{IN} < +5.5V, PV _{DD} should be tied to PV _{IN} pins. A 2.2 μF ceramic capacitor from the PV _{DD} pin to PGND (Pin 2) must be place next to the IC.
2, 5, 6, 7, 8, 21	PGND	Power Ground. PGND is the ground path for the MIC24051 buck converter power stage. The PGND pins connect to the low-side N-Channel internal MOSFET gate drive supply ground, the sources of the MOSFETs, the negative terminals of input capacitors, and the negative terminals of output capacitors. The loop for the power ground should be as small as possible and separate from the signal ground (SGND) loop.
3	NC	No connect.
4, 9, 10, 11, 12	SW	Switch Node output. Internal connection for the high-side MOSFET source and low-side MOSFET drain. Due to the high-speed switching on this pin, the SW pin should be routed away from sensitive nodes.
13,14,15, 16,17,18,19	PV _{IN}	High-Side N-internal MOSFET Drain Connection input. The PV _{IN} operating voltage range is from 4.5V to 19V. Input capacitors between the PV _{IN} pins and the Power Ground (PGND) are required and keep the connection short.
20	BST	Boost output. Bootstrapped voltage to the high-side N-channel MOSFET driver. A Schottky diode is connected between the PV _{DD} pin and the BST pin. A boost capacitor of 0.1 μF is connected between the BST pin and the SW pin. Adding a small resistor at the BST pin can slow down the turn-on time of high-side N-Channel MOSFETs.
22	CS	Current Sense input. The CS pin senses current by monitoring the voltage across the low-side MOSFET during the OFF-time. The current sensing is necessary for short circuit protection. In order to sense the current accurately, connect the low-side MOSFET drain to SW using a Kelvin connection. The CS pin is also the high-side MOSFET's output driver return.
23	SGND	Signal Ground. SGND must be connected directly to the ground planes. Do not route the SGND pin to the PGND Pad on the top layer (see PCB Layout Recommendations for details).
24	FB	Feedback input. Input to the transconductance amplifier of the control loop. The FB pin is regulated to 0.8V. A resistor divider connecting the feedback to the output is used to adjust the desired output voltage.
25	PG	Power Good output. Open drain output. The PG pin is externally tied with a resistor to V _{DD} . A high output is asserted when V _{OUT} > 92% of nominal.
26	EN	Enable input. A logic level control of the output. The EN pin is CMOS-compatible. Logic high = enable, logic low = shutdown. In the off state, supply current of the device is greatly reduced (typically 5 μA). The EN pin should not be left floating.
27	V _{IN}	Power Supply Voltage input. Requires bypass capacitor to SGND.
28	V _{DD}	5V Internal Linear Regulator output. V _{DD} supply is the supply bus for the IC control circuit. V _{DD} is created by internal LDO from V _{IN} . When V _{IN} < +5.5V, V _{DD} should be tied to PV _{IN} pins. A 1 μF ceramic capacitor from the V _{DD} pin to SGND pins must be place next to the IC.

4.0 FUNCTIONAL DESCRIPTION

The MIC24051 is an adaptive ON-time synchronous step-down DC/DC regulator with an internal 5V linear regulator and a Power Good (PG) output. It is designed to operate over a wide input voltage range from 4.5V to 19V and provides a regulated output voltage at up to 6A of output current. An adaptive ON-time control scheme is employed in to obtain a constant switching frequency and to simplify the control compensation. Overcurrent protection is implemented without the use of an external sense resistor. The device includes an internal soft-start function which reduces the power supply input surge current at start-up by controlling the output voltage rise time.

4.1 Theory of Operation

The MIC24051 operates in a continuous mode as shown in the [Block Diagram](#).

4.2 Continuous Mode

In continuous mode, the output voltage is sensed by the MIC24051 feedback pin FB via the voltage divider R1 and R2, and compared to a 0.8V reference voltage V_{REF} at the error comparator through a low gain transconductance (g_m) amplifier. If the feedback voltage decreases and the output of the g_m amplifier is below 0.8V, then the error comparator will trigger the control logic and generate an ON-time period. The ON-time period length is predetermined by the “FIXED t_{ON} ESTIMATION” circuitry:

EQUATION 4-1:

$$t_{ON(ESTIMATED)} = \frac{V_{OUT}}{V_{IN} \times 600kHz}$$

Where:

V_{OUT} Output voltage
 V_{IN} Power stage input voltage

At the end of the ON-time period, the internal high-side driver turns off the high-side MOSFET and the low-side driver turns on the low-side MOSFET. The OFF-time period length depends upon the feedback voltage in most cases. When the feedback voltage decreases and the output of the g_m amplifier is below 0.8V, the ON-time period is triggered and the OFF-time period ends. If the OFF-time period determined by the feedback voltage is less than the minimum OFF-time $t_{OFF(min)}$, which is about 300 ns, the MIC24051 control logic will apply the $t_{OFF(min)}$ instead. $t_{OFF(min)}$ is required to maintain enough energy in the boost capacitor (C_{BST}) to drive the high-side MOSFET.

The maximum duty cycle is obtained from the 300 ns $t_{OFF(min)}$:

EQUATION 4-2:

$$D_{MAX} = \frac{t_S - t_{OFF(MIN)}}{t_S} = 1 - \frac{300ns}{t_S}$$

Where:

$$t_S \quad 1/600 \text{ kHz} = 1.66 \mu s$$

It is not recommended to use MIC24051 with a OFF-time close to $t_{OFF(min)}$ during steady-state operation. Also, as V_{OUT} increases, the internal ripple injection will increase and reduce the line regulation performance. Therefore, the maximum output voltage of the MIC24051 should be limited to 5.5V and the maximum external ripple injection should be limited to 200 mV. Please refer to [Setting Output Voltage](#) in the [Application Information](#) section for more details.

The actual ON-time and resulting switching frequency will vary with the part-to-part variation in the rise and fall times of the internal MOSFETs, the output load current, and variations in the V_{DD} voltage. Also, the minimum t_{ON} results in a lower switching frequency in high V_{IN} to V_{OUT} applications, such as 18V to 1.0V. The minimum t_{ON} measured on the MIC24051 evaluation board is about 100 ns. During load transients, the switching frequency is changed due to the varying OFF-time.

To illustrate the control loop operation, we will analyze both the steady-state and load transient scenarios. [Figure 4-1](#) shows the MIC24051 control loop timing during steady-state operation. During steady-state, the g_m amplifier senses the feedback voltage ripple, which is proportional to the output voltage ripple and the inductor current ripple, to trigger the ON-time period. The ON-time is predetermined by the t_{ON} estimator. The termination of the OFF-time is controlled by the feedback voltage. At the valley of the feedback voltage ripple, which occurs when V_{FB} falls below V_{REF} , the OFF period ends and the next ON-time period is triggered through the control logic circuitry.

MIC24051

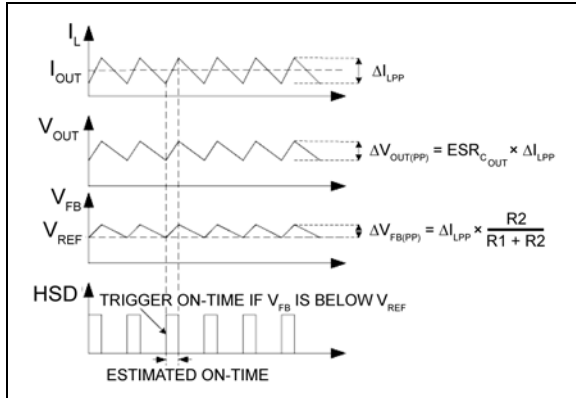

FIGURE 4-1: MIC24051 Control Loop Timing.

Figure 4-2 shows the operation of the MIC24051 during a load transient. The output voltage drops due to the sudden load increase, which causes the V_{FB} to be less than V_{REF} . This will cause the error comparator to trigger an ON-time period. At the end of the ON-time period, a minimum OFF-time $t_{OFF(min)}$ is generated to charge C_{BST} because the feedback voltage is still below V_{REF} . Then, the next ON-time period is triggered due to the low feedback voltage. Therefore, the switching frequency changes during the load transient, but returns to the nominal fixed frequency once the output has stabilized at the new load current level. With the varying duty cycle and switching frequency, the output recovery time is fast and the output voltage deviation is small in MIC24051 converter.

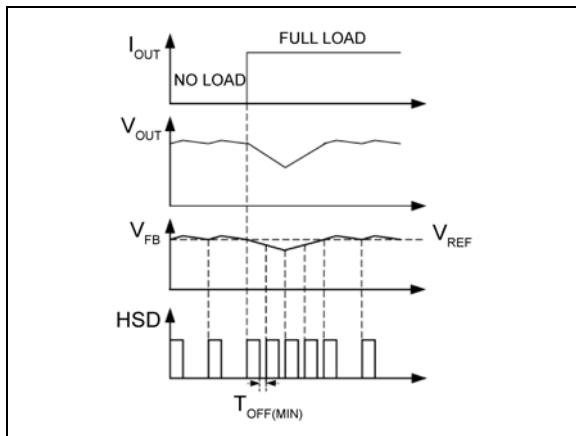

FIGURE 4-2: MIC24051 Load Transient Response.

Unlike true current-mode control, the MIC24051 uses the output voltage ripple to trigger an ON-time period. The output voltage ripple is proportional to the inductor current ripple if the ESR of the output capacitor is large enough. The MIC24051 control loop has the advantage of eliminating the need for slope compensation.

In order to meet the stability requirements, the MIC24051 feedback voltage ripple should be in phase with the inductor current ripple and large enough to be

sensed by the gm amplifier and the error comparator. The recommended feedback voltage ripple is 20 mV~100 mV. If a low-ESR output capacitor is selected, then the feedback voltage ripple may be too small to be sensed by the gm amplifier and the error comparator. Also, the output voltage ripple and the feedback voltage ripple are not necessarily in phase with the inductor current ripple if the ESR of the output capacitor is very low. In these cases, ripple injection is required to ensure proper operation. Please refer to [Ripple Injection](#) in the [Application Information](#) section for more details about the ripple injection technique.

4.3 V_{DD} Regulator

The MIC24051 provides a 5V regulated output for input voltage V_{IN} ranging from 5.5V to 19V. When $V_{IN} < 5.5V$, V_{DD} should be tied to PV_{IN} pins to bypass the internal linear regulator.

4.4 Soft-Start

Soft-start reduces the power supply input surge current at startup by controlling the output voltage rise time. The input surge appears while the output capacitor is charged up. A slower output rise time will draw a lower input surge current.

The MIC24051 implements an internal digital soft-start by making the 0.8V reference voltage V_{REF} ramp from 0 to 100% in about 3 ms with 9.7 mV steps. Therefore, the output voltage is controlled to increase slowly by a stair-case V_{FB} ramp. Once the soft-start cycle ends, the related circuitry is disabled to reduce current consumption. V_{DD} must be powered up at the same time or after V_{IN} to make the soft-start function correctly.

4.5 Current Limit

The MIC24051 uses the $R_{DS(ON)}$ of the internal low-side power MOSFET to sense over-current conditions. This method will avoid adding cost, board space and power losses taken by a discrete current sense resistor. The low-side MOSFET is used because it displays much lower parasitic oscillations during switching than the high-side MOSFET.

In each switching cycle of the MIC24051 converter, the inductor current is sensed by monitoring the low-side MOSFET in the OFF period. If the peak inductor current is greater than 11A, then the MIC24051 turns off the high-side MOSFET and a soft-start sequence is triggered. This mode of operation is called “hiccup mode” and its purpose is to protect the downstream load in case of a hard short. The load current-limit threshold has a fold-back characteristic related to the feedback voltage as shown in [Figure 4-3](#).

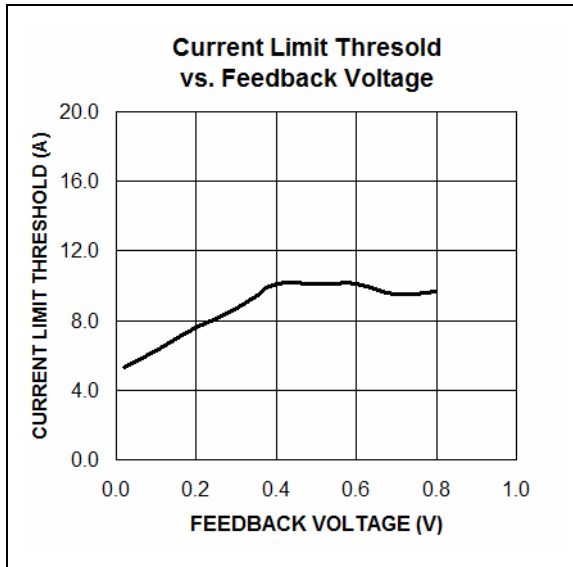

FIGURE 4-3: MIC24051 Current-Limit Foldback Characteristic.

4.6 Power Good (PG)

The Power Good (PG) pin is an open drain output which indicates logic high when the output is nominally 92% of its steady state voltage. A pull-up resistor of more than 10 k Ω should be connected from PG to V_{DD} .

4.7 MOSFET Gate Drive

The [Block Diagram](#) shows a bootstrap circuit, consisting of D1 (a Schottky diode is recommended) and C_{BST} . This circuit supplies energy to the high-side drive circuit. Capacitor C_{BST} is charged, while the low-side MOSFET is on, and the voltage on the SW pin is approximately 0V. When the high-side MOSFET driver is turned on, energy from C_{BST} is used to turn the MOSFET on. As the high-side MOSFET turns on, the voltage on the SW pin increases to approximately V_{IN} . Diode D1 is reverse biased and C_{BST} floats high while continuing to keep the high-side MOSFET on. The bias current of the high-side driver is less than 10 mA, so a 0.1 μ F to 1 μ F is sufficient to hold the gate voltage with minimal droop for the power stroke (high-side switching) cycle, i.e. $\Delta BST = 10 \text{ mA} \times 1.67 \mu\text{s} / 0.1 \mu\text{F} = 167 \text{ mV}$. When the low-side MOSFET is turned back on, C_{BST} is recharged through D1. A small resistor R_G , which is in series with C_{BST} , can be used to slow down the turn-on time of the high-side N-channel MOSFET.

The drive voltage is derived from the V_{DD} supply voltage. The nominal low-side gate drive voltage is V_{DD} and the nominal high-side gate drive voltage is approximately $V_{DD} - V_{DIODE}$, where V_{DIODE} is the voltage drop across D1. An approximate 30 ns delay between the high-side and low-side driver transitions is used to prevent current from simultaneously flowing unimpeded through both MOSFETs.

5.0 APPLICATION INFORMATION

5.1 Inductor Selection

Values for inductance, peak, and RMS currents are required to select the output inductor. The input and output voltages and the inductance value determine the peak-to-peak inductor ripple current. Generally, higher inductance values are used with higher input voltages. Larger peak-to-peak ripple currents will increase the power dissipation in the inductor and MOSFETs. Larger output ripple currents will also require more output capacitance to smooth out the larger ripple current. Smaller peak-to-peak ripple currents require a larger inductance value and therefore a larger and more expensive inductor. A good compromise between size, loss and cost is to set the inductor ripple current to be equal to 20% of the maximum output current. The inductance value is calculated in [Equation 5-1](#).

EQUATION 5-1:

$$L = \frac{V_{OUT} \times (V_{IN(MAX)} - V_{OUT})}{V_{IN(MAX)} \times f_{SW} \times 20\% \times I_{OUT(MAX)}}$$

Where:

f_{SW}	Switching frequency, 600 kHz
20%	Ratio of AC ripple current to DC output current
$V_{IN(MAX)}$	Maximum power stage input voltage

The peak-to-peak inductor current ripple is:

EQUATION 5-2:

$$\Delta I_{L(PP)} = \frac{V_{OUT} \times (V_{IN(MAX)} - V_{OUT})}{V_{IN(MAX)} \times f_{SW} \times L}$$

The peak inductor current is equal to the average output current plus one half of the peak-to-peak inductor current ripple.

EQUATION 5-3:

$$I_{L(PK)} = I_{OUT(MAX)} + 0.5 \times \Delta I_{L(PP)}$$

The RMS inductor current is used to calculate the I^2R losses in the inductor.

EQUATION 5-4:

$$I_{L(RMS)} = \sqrt{I_{OUT(MAX)}^2 + \frac{\Delta I_{L(PP)}^2}{12}}$$

Maximizing efficiency requires the proper selection of core material and minimizing the winding resistance. The high-frequency operation of the MIC24051 requires the use of ferrite materials for all but the most cost sensitive applications. Lower cost iron powder cores may be used but the increase in core loss will reduce the efficiency of the power supply. This is especially noticeable at low output power. The winding resistance decreases efficiency at the higher output current levels. The winding resistance must be minimized although this usually comes at the expense of a larger inductor. The power dissipated in the inductor is equal to the sum of the core and copper losses. At higher output loads, the core losses are usually insignificant and can be ignored. At lower output currents, the core losses can be a significant contributor. Core loss information is usually available from the magnetics vendor. Copper loss in the inductor is calculated by [Equation 5-5](#):

EQUATION 5-5:

$$P_{INDUCTOR(CU)} = I_{L(RMS)}^2 \times R_{WINDING}$$

The resistance of the copper wire, $R_{WINDING}$, increases with the temperature. The value of the winding resistance used should be at the operating temperature.

EQUATION 5-6:

$$R_{WINDING(HT)} = R_{WINDING(20C)} \times (1 + 0.0042 \times [T_H - T_{20C}])$$

Where:

T_H	Temperature of wire under full load
T_{20C}	Ambient temperature
$R_{WINDING(20C)}$	Room temperature winding resistance (usually specified by the manufacturer)

5.2 Output Capacitor Selection

The type of the output capacitor is usually determined by its equivalent series resistance (ESR). Voltage and RMS current capability are two other important factors for selecting the output capacitor. Recommended capacitor types are ceramic, low-ESR aluminum electrolytic, OS-CON and POSCAP. The output capacitor's ESR is usually the main cause of the output ripple. The output capacitor ESR also affects the control loop from a stability point of view.

The maximum value of ESR is calculated:

EQUATION 5-7:

$$ESR_{COUT} \leq \frac{\Delta V_{OUT(PP)}}{\Delta I_{L(PP)}}$$

Where:

- $\Delta V_{OUT(PP)}$ Peak-to-peak output voltage ripple
- $\Delta I_{L(PP)}$ Peak-to-peak inductor current ripple

The total output ripple is a combination of the ESR and output capacitance. The total ripple is calculated in [Equation 5-8](#):

EQUATION 5-8:

$$\Delta V_{OUT(PP)} = \sqrt{\left(\frac{\Delta I_{L(PP)}}{C_{OUT} \times f_{SW} \times 8}\right)^2 + (\Delta I_{L(PP)} \times ESR_{COUT})^2}$$

Where:

- C_{OUT} Output capacitance value
- f_{SW} Switching frequency

As described in the [Theory of Operation](#) section, the MIC24051 requires at least 20 mV peak-to-peak ripple at the FB pin to make the g_m amplifier and the error comparator behave properly. Also, the output voltage ripple should be in phase with the inductor current. Therefore, the output voltage ripple caused by the output capacitors value should be much smaller than the ripple caused by the output capacitor ESR. If low-ESR capacitors, such as ceramic capacitors, are selected as the output capacitors, a ripple injection method should be applied to provide the enough feedback voltage ripple. Please refer to the [Ripple Injection](#) section for more details.

The voltage rating of the capacitor should be twice the output voltage for a tantalum and 20% greater for aluminum electrolytic or OS-CON. The output capacitor RMS current is calculated in [Equation 5-9](#):

EQUATION 5-9:

$$I_{COUT(RMS)} = \frac{\Delta I_{L(PP)}}{\sqrt{12}}$$

The power dissipated in the output capacitor is:

EQUATION 5-10:

$$P_{DISS(COUT)} = I_{COUT(RMS)} \times ESR_{COUT}$$

5.3 Input Capacitor Selection

The input capacitor for the power stage input V_{IN} should be selected for ripple current rating and voltage rating. Tantalum input capacitors may fail when subjected to high inrush currents, caused by turning the input supply on. A tantalum input capacitor's voltage rating should be at least two times the maximum input voltage to maximize reliability. Aluminum electrolytic, OS-CON, and multilayer polymer film capacitors can handle the higher inrush currents without voltage de-rating. The input voltage ripple will primarily depend on the input capacitor's ESR. The peak input current is equal to the peak inductor current, so:

EQUATION 5-11:

$$\Delta V_{IN} = I_{L(PK)} \times ESR_{CIN}$$

The input capacitor must be rated for the input current ripple. The RMS value of input capacitor current is determined at the maximum output current. Assuming the peak-to-peak inductor current ripple is low:

EQUATION 5-12:

$$I_{CIN(RMS)} \approx I_{OUT(MAX)} \times \sqrt{D \times (1 - D)}$$

MIC24051

The power dissipated in the input capacitor is:

EQUATION 5-13:

$$P_{DISS(CIN)} = I_{CIN(RMS)} \times ESR_{CIN}$$

5.4 Ripple Injection

The V_{FB} ripple required for proper operation of the MIC24051 g_m amplifier and error comparator is 20 mV to 100 mV. However, the output voltage ripple is generally designed as 1% to 2% of the output voltage. For a low output voltage, such as a 1V, the output voltage ripple is only 10 mV to 20 mV, and the feedback voltage ripple is less than 20 mV. If the feedback voltage ripple is so small that the g_m amplifier and error comparator can't sense it, then the MIC24051 will lose control and the output voltage is not regulated. In order to have some amount of V_{FB} ripple, a ripple injection method is applied for low output voltage ripple applications.

The applications are divided into three situations according to the amount of the feedback voltage ripple:

1. Enough ripple at the feedback voltage due to the large ESR of the output capacitors.

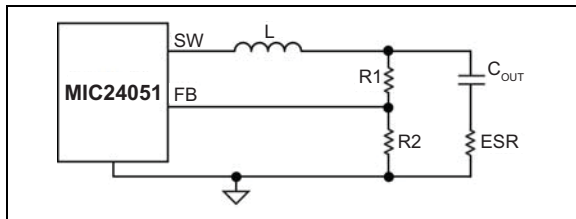

FIGURE 5-1: *Enough Ripple at FB.*

As shown in Figure 5-1, the converter is stable without any ripple injection. The feedback voltage ripple is:

EQUATION 5-14:

$$\Delta V_{FB(PP)} = \frac{R2}{R1 + R2} \times ESR_{COUT} \times \Delta I_{L(PP)}$$

Where:

$\Delta I_{L(PP)}$ Peak-to-peak value of the inductor current ripple

2. Inadequate ripple at the feedback voltage due to the small ESR of the output capacitors.

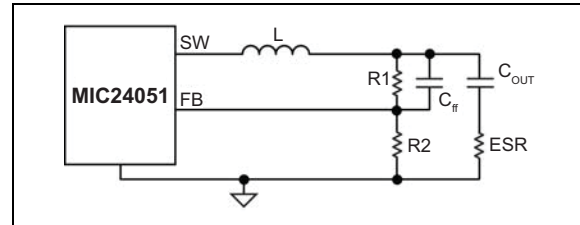

FIGURE 5-2: *Inadequate Ripple at FB.*

The output voltage ripple is fed into the FB pin through a feed-forward capacitor C_{FF} in this situation, as shown in Figure 5-2. The typical C_{FF} value is between 1 nF and 100 nF. With the feed-forward capacitor, the feedback voltage ripple is very close to the output voltage ripple:

EQUATION 5-15:

$$\Delta V_{FB(PP)} \approx ESR \times \Delta I_{L(PP)}$$

3. Virtually no ripple at the FB pin voltage due to the very low ESR of the output capacitors.

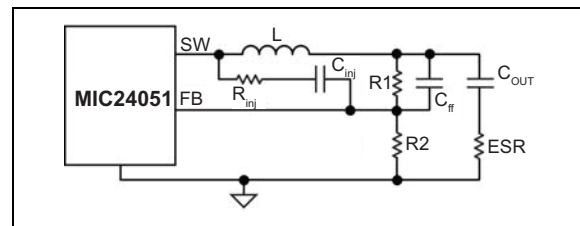

FIGURE 5-3: *Invisible Ripple at FB.*

In this situation, the output voltage ripple is less than 20 mV. Therefore, additional ripple is injected into the FB pin from the switching node SW via a resistor R_{INJ} and a capacitor C_{INJ} , as shown in Figure 5-3. The injected ripple is:

EQUATION 5-16:

$$\Delta V_{FB(PP)} = V_{IN} \times K_{DIV} \times D \times (1 - D) \times \frac{1}{f_{SW} \times \tau}$$

Where:

V_{IN} Power stage input voltage
 D Duty cycle
 f_{SW} Switching frequency
 τ $(R1//R2//R_{INJ}) \times C_{FF}$

EQUATION 5-17:

$$K_{DIV} = \frac{R1//R2}{R_{INJ} + R1//R2}$$

In Equation 5-16 and Equation 5-17, it is assumed that the time constant associated with C_{ff} must be much greater than the switching period:

EQUATION 5-18:

$$\frac{1}{f_{SW} \times \tau} = \frac{T}{\tau} \ll 1$$

If the voltage divider resistors R1 and R2 are in the k Ω range, a C_{ff} of 1 nF to 100 nF can easily satisfy the large time constant requirements. Also, a 100 nF injection capacitor C_{INJ} is used in order to be considered as short for a wide range of the frequencies.

The process of sizing the ripple injection resistor and capacitors is:

1. Select C_{ff} to feed all output ripples into the feedback pin and make sure the large time constant assumption is satisfied. Typical choice of C_{ff} is 1 nF to 100 nF if R1 and R2 are in k Ω range.
2. Select R_{INJ} according to the expected feedback voltage ripple using Equation 5-19.

EQUATION 5-19:

$$K_{DIV} = \frac{\Delta V_{FB(PP)}}{V_{IN}} \times \frac{f_{SW} \times \tau}{D \times (1 - D)}$$

Then the value of R_{INJ} is obtained as:

EQUATION 5-20:

$$R_{INJ} = (R1//R2) \times \left(\frac{1}{K_{DIV}} - 1 \right)$$

3. Select C_{INJ} as 100 nF, which could be considered as short for a wide range of the frequencies.

5.5 Setting Output Voltage

The MIC24051 requires two resistors to set the output voltage as shown in Figure 5-4.

The output voltage is determined by Equation 5-21:

EQUATION 5-21:

$$V_{OUT} = V_{FB} \times \left(1 + \frac{R1}{R2} \right)$$

V_{FB} equals 0.8V. A typical value of R1 can be between 3 k Ω and 10 k Ω . If R1 is too large, it may allow noise to be introduced into the voltage feedback loop. If R1 is too small, it will decrease the efficiency of the power supply, especially at light loads. Once R1 is selected, R2 can be calculated using:

EQUATION 5-22:

$$R2 = \frac{V_{FB} \times R1}{V_{OUT} - V_{FB}}$$

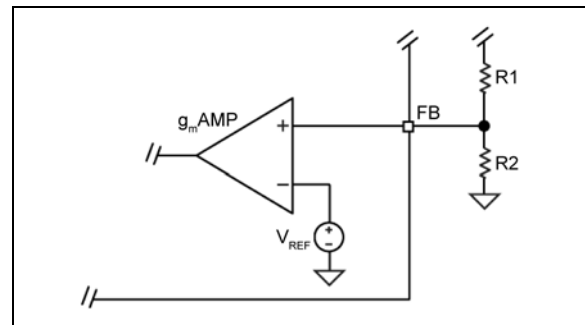

FIGURE 5-4: Voltage Divider Configuration.

In addition to the external ripple injection added at the FB pin, internal ripple injection is added at the inverting input of the comparator inside the MIC24051, as shown in Figure 5-5. The inverting input voltage V_{INJ} is clamped to 1.2V. As V_{OUT} is increased, the swing of V_{INJ} will be clamped. The clamped V_{INJ} reduces the line regulation because it is reflected as a DC error on the FB terminal. Therefore, the maximum output voltage of the MIC24051 should be limited to 5.5V to avoid this problem.

MIC24051

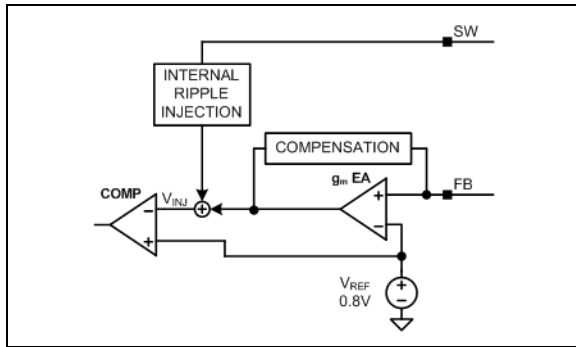

FIGURE 5-5: *Internal Ripple Injection.*

5.6 Thermal Measurements

Measuring the IC's case temperature is recommended to ensure it is within its operating limits. Although this might seem like a very elementary task, it is easy to get erroneous results. The most common mistake is to use the standard thermal couple that comes with a thermal meter. This thermal couple wire gauge is large, typically 22 gauge, and behaves like a heatsink, resulting in a lower case measurement.

Two methods of temperature measurement are using a smaller thermal couple wire or an infrared thermometer. If a thermal couple wire is used, it must be constructed of 36 gauge wire or higher then (smaller wire size) to minimize the wire heat-sinking effect. In addition, the thermal couple tip must be covered in either thermal grease or thermal glue to make sure that the thermal couple junction is making good contact with the case of the IC. Omega brand thermal couple (5SC-TT-K-36-36) is adequate for most applications.

Wherever possible, an infrared thermometer is recommended. The measurement spot size of most infrared thermometers is too large for an accurate reading on a small form factor ICs. However, an IR thermometer from Optris has a 1 mm spot size, which makes it a good choice for measuring the hottest point on the case. An optional stand makes it easy to hold the beam on the IC for long periods of time.

6.0 PCB LAYOUT RECOMMENDATIONS

To minimize EMI and output noise, follow these layout recommendations.

PCB layout is critical to achieve reliable, stable and efficient performance. A ground plane is required to control EMI and minimize the inductance in power, signal and return paths.

The following guidelines should be followed to insure proper operation of the MIC24051 regulator.

6.1 IC

- A 2.2 μF ceramic capacitor, which is connected to the PV_{DD} pin, must be located right at the IC. The PV_{DD} pin is very noise sensitive and placement of the capacitor is very critical. Use wide traces to connect to the PV_{DD} and PGND pins.
- A 1 μF ceramic capacitor must be placed right between V_{DD} and the signal ground SGND . The SGND must be connected directly to the ground planes. Do not route the SGND pin to the PGND Pad on the top layer.
- Place the IC close to the point-of-load (POL).
- Use fat traces to route the input and output power lines.
- Signal and power grounds should be kept separate and connected at only one location.

6.2 Input Capacitor

- Place the input capacitors on the same side of the board and as close to the IC as possible.
- Keep both the PV_{IN} pin and PGND connections short.
- Place several vias to the ground plane close to the input capacitor ground terminal.
- Use either X7R or X5R dielectric input capacitors. Do not use Y5V or Z5U type capacitors.
- Do not replace the ceramic input capacitor with any other type of capacitor. Any type of capacitor can be placed in parallel with the input capacitor.
- If a Tantalum input capacitor is placed in parallel with the input capacitor, it must be recommended for switching regulator applications and the operating voltage must be derated by 50%.
- In "Hot-Plug" applications, a Tantalum or Electrolytic bypass capacitor must be used to limit the over-voltage spike seen on the input supply with power is suddenly applied.

6.3 Inductor

- Keep the inductor connection to the switch node (SW) short.
- Do not route any digital lines underneath or close

to the inductor.

- Keep the switch node (SW) away from the feedback (FB) pin.
- The CS pin should be connected directly to the SW pin to accurately sense the voltage across the low-side MOSFET.
- To minimize noise, place a ground plane underneath the inductor.
- The inductor can be placed on the opposite side of the PCB with respect to the IC. It does not matter whether the IC or inductor is on the top or bottom as long as there is enough air flow to keep the power components within their temperature limits. The input and output capacitors must be placed on the same side of the board as the IC.

6.4 Output Capacitor

- Use a wide trace to connect the output capacitor ground terminal to the input capacitor ground terminal.
- Phase margin will change as the output capacitor value and ESR changes. Contact the factory if the output capacitor is different from what is shown in the user guide.
- The feedback trace should be separate from the power trace and connected as close as possible to the output capacitor. Sensing a long high-current load trace can degrade the DC load regulation.

6.5 Optional RC Snubber

- Place the RC snubber on either side of the board and as close to the SW pin as possible.

MIC24051

7.0 PACKAGING INFORMATION

7.1 Package Marking Information

28-Pin QFN*

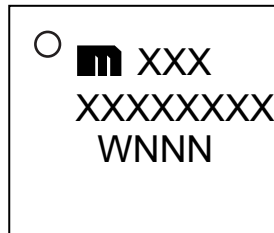

Example

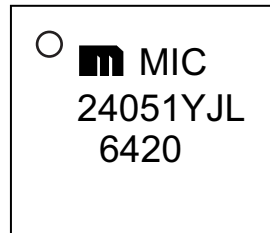

Legend:	XX...X	Product code or customer-specific information
	Y	Year code (last digit of calendar year)
	YY	Year code (last 2 digits of calendar year)
	WW	Week code (week of January 1 is week '01')
	NNN	Alphanumeric traceability code
	(e3)	Pb-free JEDEC® designator for Matte Tin (Sn)
	*	This package is Pb-free. The Pb-free JEDEC designator ((e3)) can be found on the outer packaging for this package.
	•, ▲, ▼	Pin one index is identified by a dot, delta up, or delta down (triangle mark).
Note:	In the event the full Microchip part number cannot be marked on one line, it will be carried over to the next line, thus limiting the number of available characters for customer-specific information. Package may or may not include the corporate logo.	
	Underbar (¯) and/or Overbar (¯) symbol may not be to scale.	

28-Pin 5 mm x 6 mm QFN Package Outline and Recommended Land Pattern

TITLE

28 LEAD QFN 5X6mm PACKAGE OUTLINE (Co-Package) & RECOMMENDED LAND PATTERN

DRAWING # QFN56-28LD-PL-1

UNIT MM

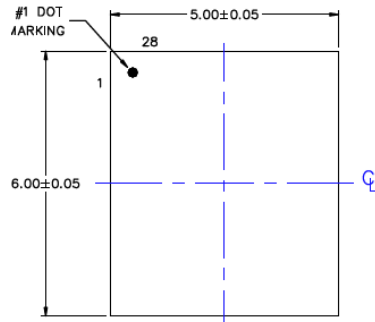

TOP VIEW
NOTE: 1, 2, 3

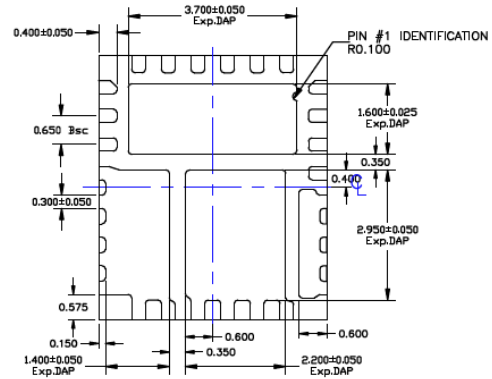

BOTTOM VIEW
NOTE: 1, 2, 3

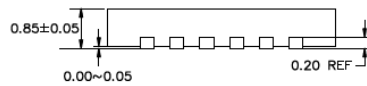

SIDE VIEW
NOTE: 1, 2, 3

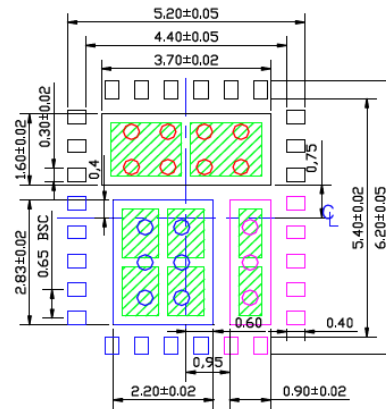

RECOMMENDED LAND PATTERN
NOTE: 4, 5

NOTE:

1. MAX PACKAGE WARPAGE IS 0.05 MM
2. MAX ALLOWABLE BURR IS 0.076MM IN ALL DIRECTIONS
3. PIN #1 IS ON TOP WILL BE LASER MARKED
4. RED CIRCLES IN LAND PATTERN REPRESENT THERMAL VIA & SHOULD BE CONNECTED TO GND FOR MAXIMUM PERFORMANCE.
5. GREEN RECTANGLES (SHADED AREA) REPRESENT SOLDER STENCIL OPENING ON EXPOSED PAD AREA.
6. BLUE COLORED PADS & PURPLE COLORED PADS REPRESENT DIFFERENT POTENTIALS. DO NOT CONNECT TO GND.
7. RECOMMENDED SOLDER STENCIL OPENING AND VIA SIZES.

		Via size/Pitch	Solder stencil opening/Pitch	Comments
Red circle, black pad	Thermal Via	0.300-0.350mm/0.80mm	1.55x1.20mm/1.75mm	Must be connected to GND plane
Blue circle & pad		0.300-0.350mm/0.80mm	0.80x1.11mm/1.31mm	DO NOT connect to GND plane
Magenta circle & pad		0.300-0.350mm/0.80mm	0.50x1.11mm/1.31mm	DO NOT connect to GND plane

Note: For the most current package drawings, please see the Microchip Packaging Specification located at <http://www.microchip.com/packaging>.

APPENDIX A: REVISION HISTORY

Revision A (November 2016)

- Converted Micrel document MIC24051 to Microchip data sheet DS20005658A.
- Minor text changes throughout.
- Vertical axis description updated in [Figure 2-9](#).
- Labeling of [Figure 2-42](#) corrected V_{IN} to V_{DD} .
- Corrected a naming error in [Equation 5-6](#).
- Corrected a formatting error in [Equation 5-17](#).

MIC24051

NOTES:

PRODUCT IDENTIFICATION SYSTEM

To order or obtain information, e.g., on pricing or delivery, contact your local Microchip representative or sales office.

<u>PART NO.</u>	X	XX	-	XX
Device	Temperature	Package		Media Type
Device:	MIC24051:	12V, 6A High-Efficiency Buck Regulator with Hyper Speed Control		
Temperature:	Y =	-40°C to +125°C (Industrial)		
Package:	JL =	28-Lead 5 mm x 6 mm QFN		
Media Type:	TR =	1,000/Reel		

Examples:

a) MIC24051YJL-TR: 12V, 6A High-Efficiency Buck Regulator with Hyper Speed Control, -40°C to +125°C Temperature Range, 28-Lead QFN, 1,000/Reel

Note 1: Tape and Reel identifier only appears in the catalog part number description. This identifier is used for ordering purposes and is not printed on the device package. Check with your Microchip Sales Office for package availability with the Tape and Reel option.

MIC24051

NOTES:

Note the following details of the code protection feature on Microchip devices:

- Microchip products meet the specification contained in their particular Microchip Data Sheet.
- Microchip believes that its family of products is one of the most secure families of its kind on the market today, when used in the intended manner and under normal conditions.
- There are dishonest and possibly illegal methods used to breach the code protection feature. All of these methods, to our knowledge, require using the Microchip products in a manner outside the operating specifications contained in Microchip's Data Sheets. Most likely, the person doing so is engaged in theft of intellectual property.
- Microchip is willing to work with the customer who is concerned about the integrity of their code.
- Neither Microchip nor any other semiconductor manufacturer can guarantee the security of their code. Code protection does not mean that we are guaranteeing the product as “unbreakable.”

Code protection is constantly evolving. We at Microchip are committed to continuously improving the code protection features of our products. Attempts to break Microchip's code protection feature may be a violation of the Digital Millennium Copyright Act. If such acts allow unauthorized access to your software or other copyrighted work, you may have a right to sue for relief under that Act.

Information contained in this publication regarding device applications and the like is provided only for your convenience and may be superseded by updates. It is your responsibility to ensure that your application meets with your specifications. MICROCHIP MAKES NO REPRESENTATIONS OR WARRANTIES OF ANY KIND WHETHER EXPRESS OR IMPLIED, WRITTEN OR ORAL, STATUTORY OR OTHERWISE, RELATED TO THE INFORMATION, INCLUDING BUT NOT LIMITED TO ITS CONDITION, QUALITY, PERFORMANCE, MERCHANTABILITY OR FITNESS FOR PURPOSE. Microchip disclaims all liability arising from this information and its use. Use of Microchip devices in life support and/or safety applications is entirely at the buyer's risk, and the buyer agrees to defend, indemnify and hold harmless Microchip from any and all damages, claims, suits, or expenses resulting from such use. No licenses are conveyed, implicitly or otherwise, under any Microchip intellectual property rights unless otherwise stated.

Microchip received ISO/TS-16949:2009 certification for its worldwide headquarters, design and wafer fabrication facilities in Chandler and Tempe, Arizona; Gresham, Oregon and design centers in California and India. The Company's quality system processes and procedures are for its PIC® MCUs and dsPIC® DSCs, KEELoc® code hopping devices, Serial EEPROMs, microperipherals, nonvolatile memory and analog products. In addition, Microchip's quality system for the design and manufacture of development systems is ISO 9001:2000 certified.

**QUALITY MANAGEMENT SYSTEM
CERTIFIED BY DNV
= ISO/TS 16949 =**

Trademarks

The Microchip name and logo, the Microchip logo, AnyRate, dsPIC, FlashFlex, flexPWR, Heldo, JukeBlox, KeeLoq, KeeLoq logo, Klear, LANCheck, LINK MD, MediaLB, MOST, MOST logo, MPLAB, OptoLyzer, PIC, PICSTART, PIC32 logo, RightTouch, SpyNIC, SST, SST Logo, SuperFlash and UNI/O are registered trademarks of Microchip Technology Incorporated in the U.S.A. and other countries.

ClockWorks, The Embedded Control Solutions Company, ETHERSYNCH, Hyper Speed Control, HyperLight Load, IntelliMOS, mTouch, Precision Edge, and QUIET-WIRE are registered trademarks of Microchip Technology Incorporated in the U.S.A.

Analog-for-the-Digital Age, Any Capacitor, AnyIn, AnyOut, BodyCom, chipKIT, chipKIT logo, CodeGuard, dsPICDEM, dsPICDEM.net, Dynamic Average Matching, DAM, ECAN, EtherGREEN, In-Circuit Serial Programming, ICSP, Inter-Chip Connectivity, JitterBlocker, KlearNet, KlearNet logo, MiWi, motorBench, MPASM, MPF, MPLAB Certified logo, MPLIB, MPLINK, MultiTRAK, NetDetach, Omniscient Code Generation, PICDEM, PICDEM.net, PICkit, PICtail, PureSilicon, RightTouch logo, REAL ICE, Ripple Blocker, Serial Quad I/O, SQL, SuperSwitcher, SuperSwitcher II, Total Endurance, TSHARC, USBCheck, VariSense, ViewSpan, WiperLock, Wireless DNA, and ZENA are trademarks of Microchip Technology Incorporated in the U.S.A. and other countries.

SQTP is a service mark of Microchip Technology Incorporated in the U.S.A.

Silicon Storage Technology is a registered trademark of Microchip Technology Inc. in other countries.

GestIC is a registered trademarks of Microchip Technology Germany II GmbH & Co. KG, a subsidiary of Microchip Technology Inc., in other countries.

All other trademarks mentioned herein are property of their respective companies.

© 2016, Microchip Technology Incorporated, Printed in the U.S.A., All Rights Reserved.

ISBN: 978-1-5224-1076-8



MICROCHIP

Worldwide Sales and Service

AMERICAS

Corporate Office
2355 West Chandler Blvd.
Chandler, AZ 85224-6199
Tel: 480-792-7200
Fax: 480-792-7277
Technical Support:
<http://www.microchip.com/support>
Web Address:
www.microchip.com

Atlanta
Duluth, GA
Tel: 678-957-9614
Fax: 678-957-1455

Austin, TX
Tel: 512-257-3370

Boston
Westborough, MA
Tel: 774-760-0087
Fax: 774-760-0088

Chicago
Itasca, IL
Tel: 630-285-0071
Fax: 630-285-0075

Dallas
Addison, TX
Tel: 972-818-7423
Fax: 972-818-2924

Detroit
Novi, MI
Tel: 248-848-4000

Houston, TX
Tel: 281-894-5983

Indianapolis
Noblesville, IN
Tel: 317-773-8323
Fax: 317-773-5453
Tel: 317-536-2380

Los Angeles
Mission Viejo, CA
Tel: 949-462-9523
Fax: 949-462-9608
Tel: 951-273-7800

Raleigh, NC
Tel: 919-844-7510

New York, NY
Tel: 631-435-6000

San Jose, CA
Tel: 408-735-9110
Tel: 408-436-4270

Canada - Toronto
Tel: 905-695-1980
Fax: 905-695-2078

ASIA/PACIFIC

Asia Pacific Office
Suites 3707-14, 37th Floor
Tower 6, The Gateway
Harbour City, Kowloon

Hong Kong
Tel: 852-2943-5100
Fax: 852-2401-3431

Australia - Sydney
Tel: 61-2-9868-6733
Fax: 61-2-9868-6755

China - Beijing
Tel: 86-10-8569-7000
Fax: 86-10-8528-2104

China - Chengdu
Tel: 86-28-8665-5511
Fax: 86-28-8665-7889

China - Chongqing
Tel: 86-23-8980-9588
Fax: 86-23-8980-9500

China - Dongguan
Tel: 86-769-8702-9880

China - Guangzhou
Tel: 86-20-8755-8029

China - Hangzhou
Tel: 86-571-8792-8115
Fax: 86-571-8792-8116

China - Hong Kong SAR
Tel: 852-2943-5100
Fax: 852-2401-3431

China - Nanjing
Tel: 86-25-8473-2460
Fax: 86-25-8473-2470

China - Qingdao
Tel: 86-532-8502-7355
Fax: 86-532-8502-7205

China - Shanghai
Tel: 86-21-3326-8000
Fax: 86-21-3326-8021

China - Shenyang
Tel: 86-24-2334-2829
Fax: 86-24-2334-2393

China - Shenzhen
Tel: 86-755-8864-2200
Fax: 86-755-8203-1760

China - Wuhan
Tel: 86-27-5980-5300
Fax: 86-27-5980-5118

China - Xian
Tel: 86-29-8833-7252
Fax: 86-29-8833-7256

ASIA/PACIFIC

China - Xiamen
Tel: 86-592-2388138
Fax: 86-592-2388130

China - Zhuhai
Tel: 86-756-3210040
Fax: 86-756-3210049

India - Bangalore
Tel: 91-80-3090-4444
Fax: 91-80-3090-4123

India - New Delhi
Tel: 91-11-4160-8631
Fax: 91-11-4160-8632

India - Pune
Tel: 91-20-3019-1500

Japan - Osaka
Tel: 81-6-6152-7160
Fax: 81-6-6152-9310

Japan - Tokyo
Tel: 81-3-6880-3770
Fax: 81-3-6880-3771

Korea - Daegu
Tel: 82-53-744-4301
Fax: 82-53-744-4302

Korea - Seoul
Tel: 82-2-554-7200
Fax: 82-2-558-5932 or
82-2-558-5934

Malaysia - Kuala Lumpur
Tel: 60-3-6201-9857
Fax: 60-3-6201-9859

Malaysia - Penang
Tel: 60-4-227-8870
Fax: 60-4-227-4068

Philippines - Manila
Tel: 63-2-634-9065
Fax: 63-2-634-9069

Singapore
Tel: 65-6334-8870
Fax: 65-6334-8850

Taiwan - Hsin Chu
Tel: 886-3-5778-366
Fax: 886-3-5770-955

Taiwan - Kaohsiung
Tel: 886-7-213-7830

Taiwan - Taipei
Tel: 886-2-2508-8600
Fax: 886-2-2508-0102

Thailand - Bangkok
Tel: 66-2-694-1351
Fax: 66-2-694-1350

EUROPE

Austria - Wels
Tel: 43-7242-2244-39
Fax: 43-7242-2244-393

Denmark - Copenhagen
Tel: 45-4450-2828
Fax: 45-4485-2829

Finland - Espoo
Tel: 358-9-4520-820

France - Paris
Tel: 33-1-69-53-63-20
Fax: 33-1-69-30-90-79

France - Saint Cloud
Tel: 33-1-30-60-70-00

Germany - Garching
Tel: 49-8931-9700

Germany - Haan
Tel: 49-2129-3766400

Germany - Heilbronn
Tel: 49-7131-67-3636

Germany - Karlsruhe
Tel: 49-721-625370

Germany - Munich
Tel: 49-89-627-144-0
Fax: 49-89-627-144-44

Germany - Rosenheim
Tel: 49-8031-354-560

Israel - Ra'anana
Tel: 972-9-744-7705

Italy - Milan
Tel: 39-0331-742611
Fax: 39-0331-466781

Italy - Padova
Tel: 39-049-7625286

Netherlands - Drunen
Tel: 31-416-690399
Fax: 31-416-690340

Norway - Trondheim
Tel: 47-7289-7561

Poland - Warsaw
Tel: 48-22-3325737

Romania - Bucharest
Tel: 40-21-407-87-50

Spain - Madrid
Tel: 34-91-708-08-90
Fax: 34-91-708-08-91

Sweden - Gothenberg
Tel: 46-31-704-60-40

Sweden - Stockholm
Tel: 46-8-5090-4654

UK - Wokingham
Tel: 44-118-921-5800
Fax: 44-118-921-5820