



14 Gbps, DUAL D-TYPE FLIP-FLOP WITH COMMON CLOCK & PROGRAMMABLE OUTPUT VOLTAGE

Typical Applications

The HMC953LC4B is ideal for:

- 16G Fiber Channel
- Serial Data Transmission up to 14 Gbps
- Digital Logic Systems up to 14 GHz
- Matched Delay Applications
- Broadband Test & Measurement

Features

- Supports High Data Rates: up to 14 Gbps
- Differential or Single-Ended Operation
- Fast Rise and Fall Times: 22 / 20 ps
- Low Power Consumption: 442 mW typ.
- Programmable Differential Output Voltage Swing: 600 - 1300 mVp-p
- Propagation Delay: 104 ps
- Single Supply: -3.3 V
- 24 Lead Ceramic 4x4 mm SMT Package: 16 mm²

Functional Diagram

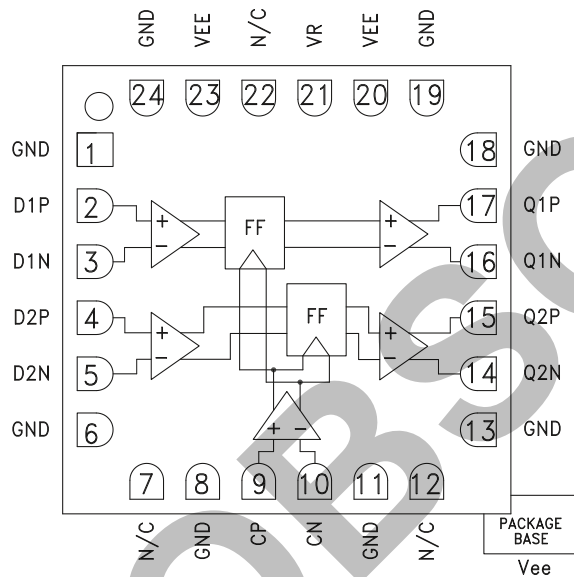

General Description

The HMC953LC4B is a Differential Dual D-Type Flip Flop with a common clock to support data transmission rates of up to 14 Gbps, and clock port operation of up to 14 GHz. During normal operation, dual differential data is transferred to the respective outputs on the positive edge of the clock. Reversing the clock inputs allows for negative-edge triggered applications. The HMC953LC4B also features an output level control pin, VR, which allows for loss compensation or for signal level optimization.

All differential input signals to the HMC953LC4B are terminated with 50 Ohms to ground on-chip, and may be either AC or DC coupled. The outputs of the HMC953LC4B may be operated either differentially or single-ended. Outputs can be connected directly to a 50 Ohm terminated system, while DC blocking capacitors may be used if the terminating system is 50 Ohms to a non-ground DC voltage. The HMC953LC4B operates from a single -3.3 V DC supply and is available in a ceramic RoHS-compliant 4x4 mm SMT package.

Electrical Specifications, $T_A = +25^\circ\text{C}$, $V_{EE} = -3.3\text{ V}$

Parameter	Conditions	Min.	Typ.	Max	Units
Power Supply Voltage		-3.6	-3.3	-3.0	V
Power Supply Current			134		mA
Maximum Data Rate			14		Gbps
Maximum Select Rate			14		GHz
Input Voltage Range		-1.5		0.5	V
Input Differential Range		0.1		2.0	Vp-p
Input Return Loss	Frequency <11 GHz		10		dB
Output Amplitude	Single-Ended, peak-to-peak		580		mVp-p
	Differential, peak-to-peak		1160		mVp-p

**14 Gbps, DUAL D-TYPE FLIP-FLOP WTH COMMON CLOCK
 & PROGRAMMABLE OUTPUT VOLTAGE**

Electrical Specifications (continued)

Parameter	Conditions	Min.	Typ.	Max	Units
Output High Voltage			-20		mV
Output Low Voltage			-600		mV
Output Rise / Fall Time	Differential, 20% - 80%		22 / 20		ps
Output Return Loss	Frequency <13 GHz		10		dB
Random Jitter, Jr	rms		0.11	0.16	ps rms
Deterministic Jitter, Jd	peak-to-peak, 2 ¹⁵ -1 PRBS input [2]		2		ps, p-p
Propagation Delay, Clock to Data, td			104		ps
Clock Phase Margin	13 GHz		245		deg
Set Up & Hold Time, t _{SH}			25		ps

DC Current vs. Supply Voltage [1][2]

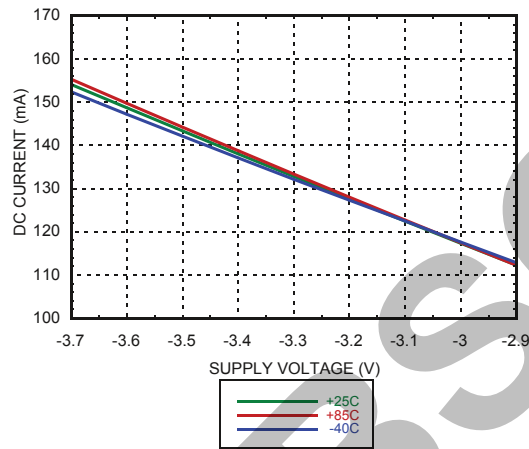

DC Current vs. VR [2][3]

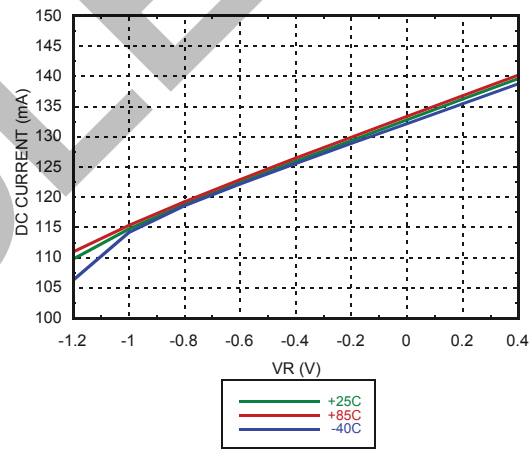

Output Differential Voltage vs. Supply Voltage [1][2]

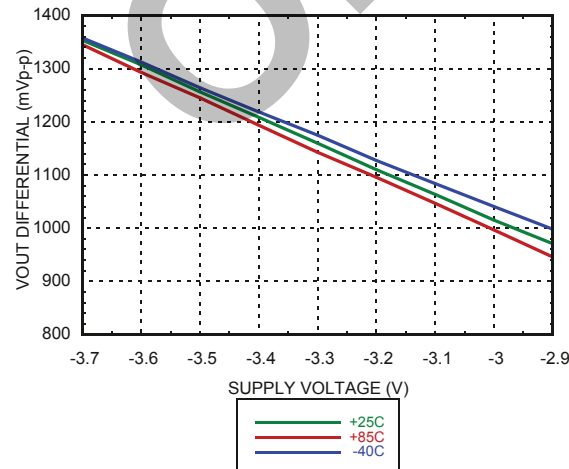

Output Differential Voltage vs. VR [2][3]

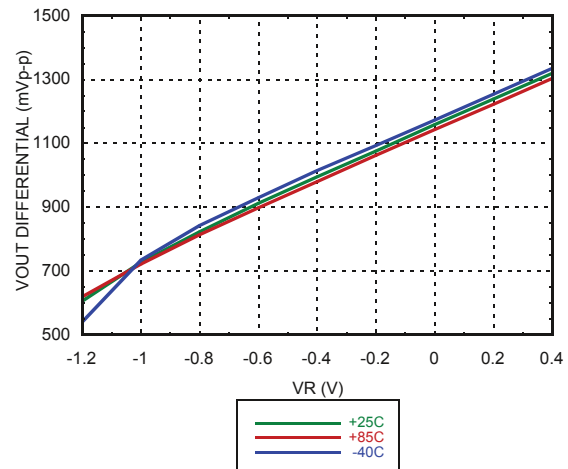

[1] VR = 0.0 V

[2] Frequency = 13 GHz

Vee = -3.3 V



14 Gbps, DUAL D-TYPE FLIP-FLOP WITH COMMON CLOCK & PROGRAMMABLE OUTPUT VOLTAGE

Rise / Fall Time vs. Supply Voltage [1][2]

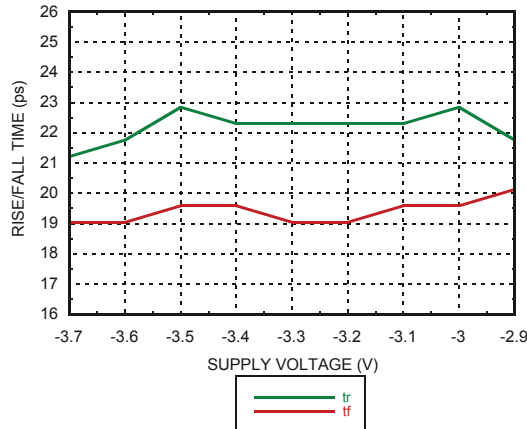

Rise / Fall Time vs. VR [2][3]

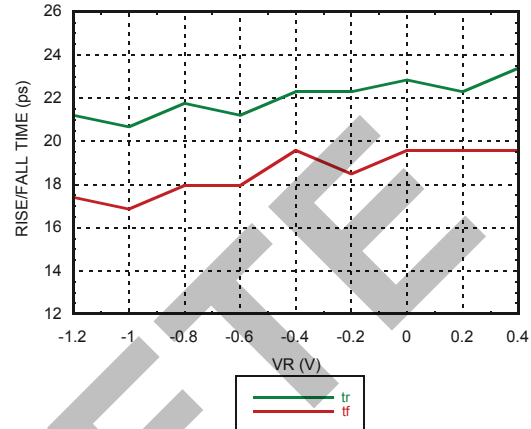

Clock Input Return Loss vs. Frequency [1][3][4]

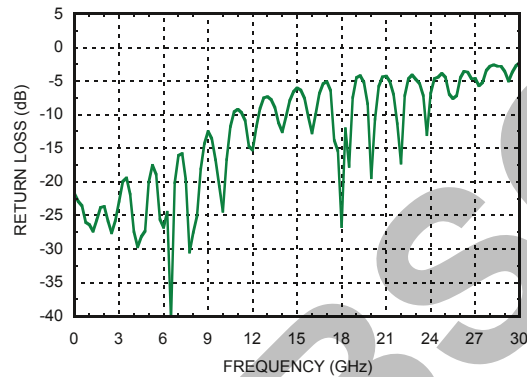

Data Input Return Loss vs. Frequency [1][3][4]

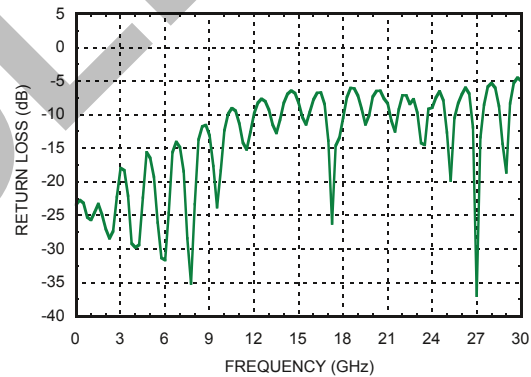

Output Return Loss vs. Frequency [1][3][4]

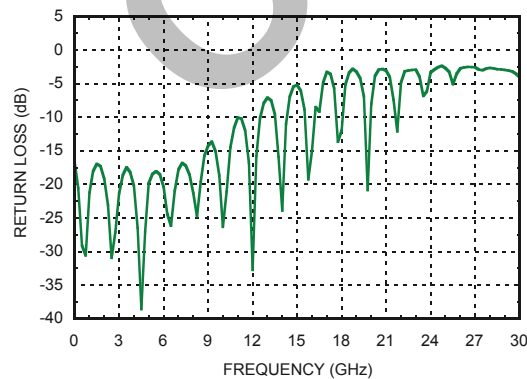

Isolation [1][3][5]

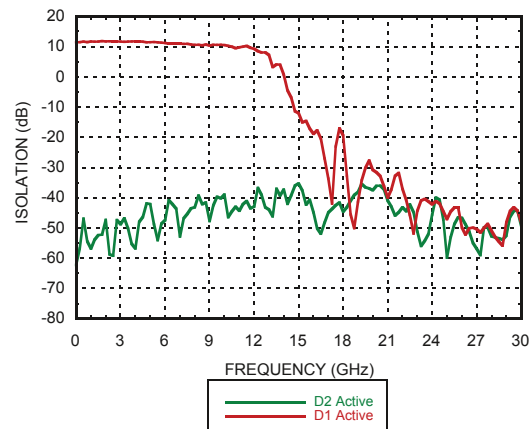

[1] VR = 0.0 V

[2] Frequency = 13 GHz

[3] Vee = -3.3 V

[4] Device measured on evaluation board with gating after connector

[5] Device measured on evaluation board with port extensions

**14 Gbps, DUAL D-TYPE FLIP-FLOP WITH COMMON CLOCK
 & PROGRAMMABLE OUTPUT VOLTAGE**

Eye Diagram

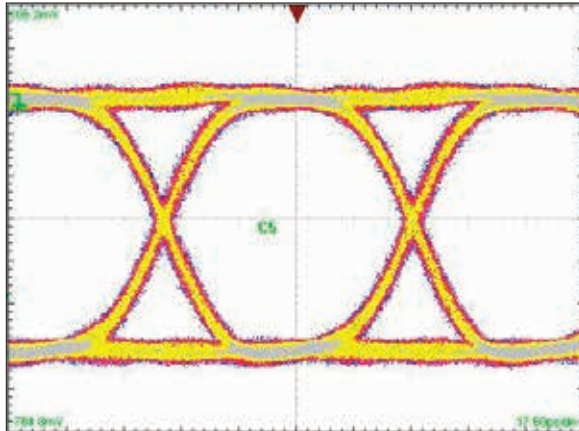

[1] Test Conditions:
 Waveform generated with an Agilent N4903A
 J-Bert differential 400 mV 13 Gbps PN 2¹⁵-1 input signal.
 Eye Diagram data presented on a Tektronix CSA 8000

Timing Diagram

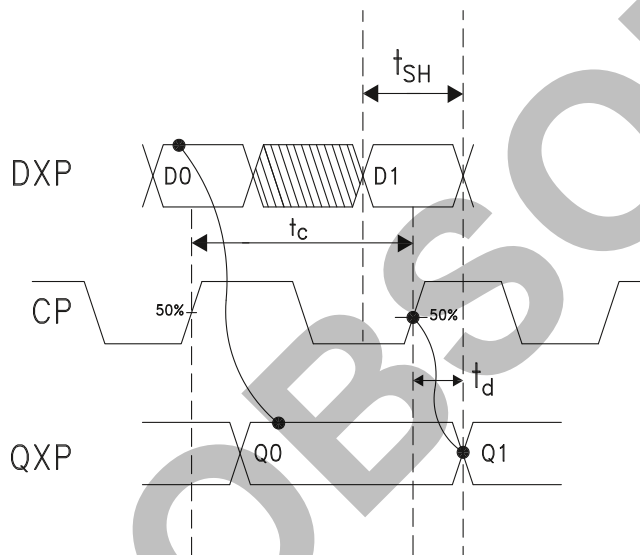

Truth Table

Inputs			Outputs	
D1	D2	C	Q1	Q2
L	X	L->H	L	X
H	X	L->H	H	X
X	L	L->H	X	L
X	H	L->H	X	H

H = Positive voltage level
 L = Negative voltage level

Notes:
 DX = DXP - DXN
 C = CP - CN
 QX = QXP - QXN

**14 Gbps, DUAL D-TYPE FLIP-FLOP WITH COMMON CLOCK
& PROGRAMMABLE OUTPUT VOLTAGE**

Absolute Maximum Ratings

Power Supply Voltage (Vee)	-3.75 V to +0.5 V
Input Signals	-2.0 V to 0.5 V
Output Signals	-1.5 V to 0.5 V
Junction Temperature	125 °C
Continuous P _{diss} (T = 85 °C (derate 30.0 mW/°C above 85 °C))	1.22 W
Thermal Resistance (R _{th-j-p}) Worst case device to package paddle	32.8 °C/W
Storage Temperature	-65 °C to +150 °C
Operating Temperature	-40 to +85 °C
ESD Sensitivity (HBM)	Class 1B



ELECTROSTATIC SENSITIVE DEVICE
OBSERVE HANDLING PRECAUTIONS

Outline Drawing

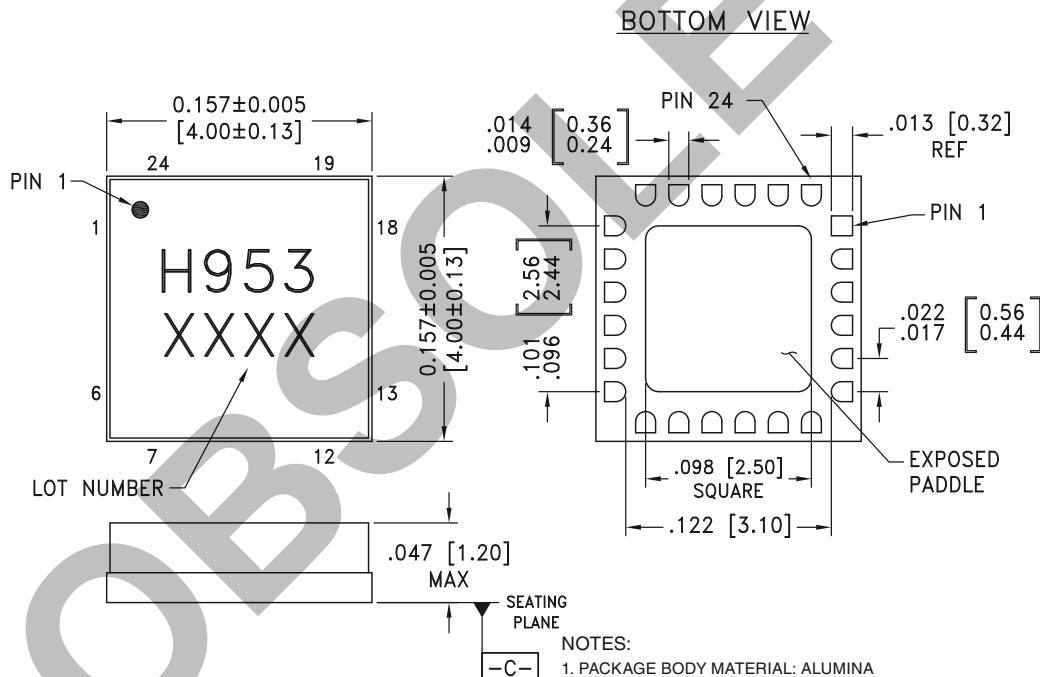

Package Information



Part Number	Package Body Material	Lead Finish	MSL Rating	Package Marking ^[2]
HMC953LC4B	Alumina, White	Gold over Nickel	MSL3 ^[1]	H953 XXXX

[1] Max peak reflow temperature of 260 °C

[2] 4-Digit lot number XXXX

**14 Gbps, DUAL D-TYPE FLIP-FLOP WITH COMMON CLOCK
 & PROGRAMMABLE OUTPUT VOLTAGE**

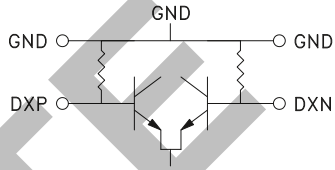
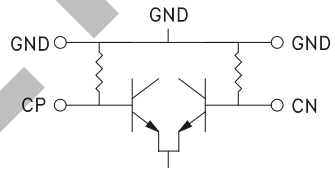
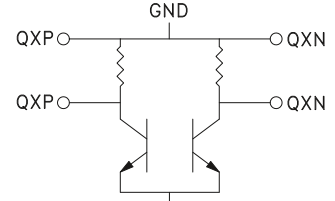
Pin Descriptions

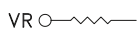
Pin Number	Function	Description	Interface Schematic
1, 6, 8, 11, 13, 18	GND	Signal Grounds.	
2, 3, 4, 5	D1P, D1N, D2P, D2N	Differential Inputs: Current Mode Logic (CML) referenced to positive supply.	
7, 12, 22	N/C	No connection necessary. These pins may be connected to RF/DC ground without affecting performance.	
9, 10	CP, CN	Differential Clock Inputs: Current Mode Logic (CML) referenced to positive supply.	
14, 15, 16, 17	Q2N, Q2P, Q1N, Q1P	Differential Outputs: Current Mode Logic (CML) referenced to positive supply.	
19, 24	GND	Supply Ground	
20, 23 Package Base	Vee	These pins and the exposed paddle must be connected to the negative voltage supply.	
21	VR	Output level control. Output level may be increased or decreased by applying a voltage to VR per "Output Differential vs. VR" plot.	

**14 Gbps, DUAL D-TYPE FLIP-FLOP WTH COMMON CLOCK
& PROGRAMMABLE OUTPUT VOLTAGE**

Evaluation PCB

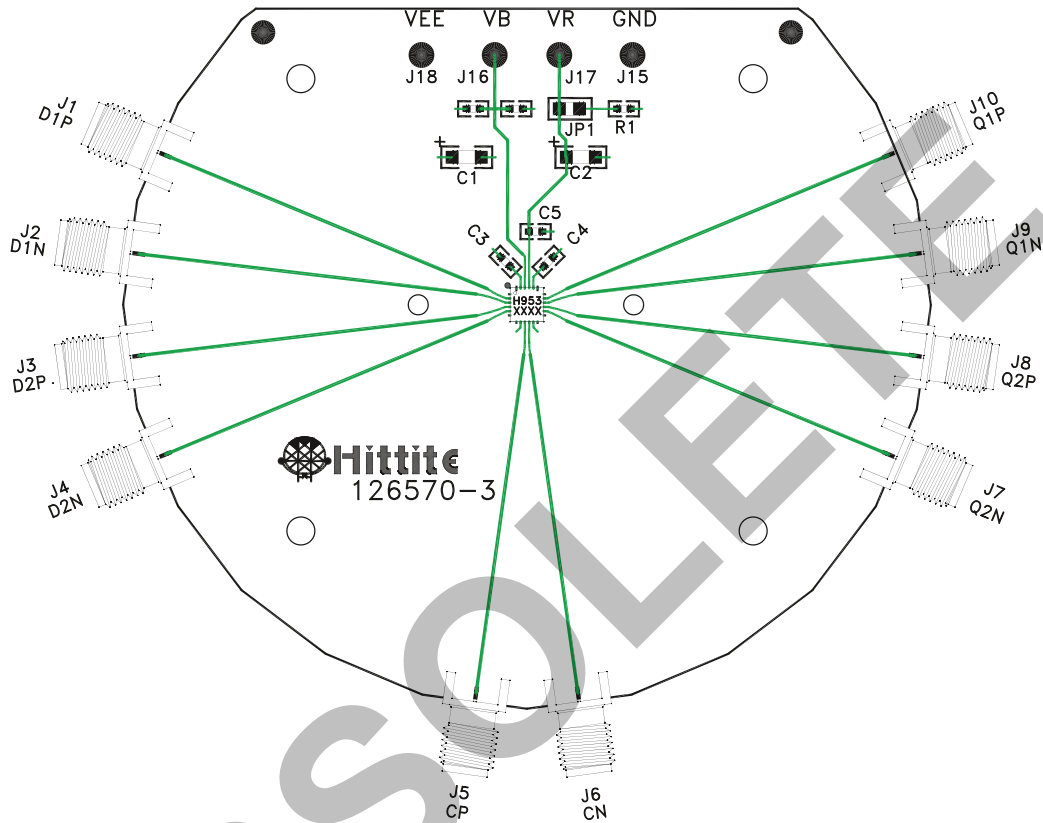

List of Materials for Evaluation PCB 126572 [1]

Item	Description
J1 - J10	PCB Mount SMA RF Connectors
J15 - J18	DC Pin
JP1	0.1" Header with Shorting Jumper
C1, C2	4.7 µF Capacitor, Tantalum
C3 - C5	100 pF Capacitor, 0603 Pkg.
R1	10 Ohm Resistor, 0603 Pkg.
U1	HMC953LC4B Dual D-Type Flip Flop
PCB [2]	126570 Evaluation Board

[1] Reference this number when ordering complete evaluation PCB

[2] Circuit Board Material: Arlon 25FR or Rogers 4350

The circuit board used in the application should use RF circuit design techniques. Signal lines should have 50 Ohm impedance while the package ground leads should be connected directly to the ground plane similar to that shown. The exposed package base should be connected to Vee. A sufficient number of via holes should be used to connect the top and bottom ground planes. The evaluation circuit board shown is available from Hittite upon request. Install jumper on JP1 to short VR to GND for normal operation.

14 Gbps, DUAL D-TYPE FLIP-FLOP WITH COMMON CLOCK & PROGRAMMABLE OUTPUT VOLTAGE

Application Circuit

