



## FEATURES

- RoHS compliant
- Inductance range from 0.25μH to 1.5μH
- Small footprint
- Ultra-low profile
- UL 94V-0 packaging materials
- Custom inductance values available

## PRODUCT OVERVIEW

The 3500 series is a range of flat-coil power inductors. They are ideal for high power designs which demand reliability in high temperature environments. Used to provide filtering or energy storage, they are suited to many power applications including portable devices, computers and telecom equipment.

## SELECTION GUIDE

| Order Code          | Inductance, L | DC Current <sup>2</sup> | DC Resistance |
|---------------------|---------------|-------------------------|---------------|
|                     | ±25%<br>μH    | Max.<br>A               | Max.<br>mΩ    |
| <b>Discontinued</b> |               |                         |               |
| <b>35251C</b>       | 0.25          | 15.5                    | 4.5           |
| <b>35501C</b>       | 0.50          | 11.5                    | 7.0           |
| <b>35801C</b>       | 0.80          | 9.5                     | 10            |
| <b>35112C</b>       | 1.10          | 8.0                     | 15            |
| <b>35152C</b>       | 1.50          | 6.5                     | 19            |

## ABSOLUTE MAXIMUM RATINGS

|                             |                |
|-----------------------------|----------------|
| Operating temperature range | -40°C to 125°C |
| Storage temperature range   | -40°C to 150°C |

## SOLDERING INFORMATION<sup>1</sup>

|                                |         |
|--------------------------------|---------|
| Peak reflow solder temperature | 250°C   |
| Pin finish                     | Tin dip |
| Moisture sensitivity level     | 1       |

## PACKAGE SPECIFICATIONS

### Mechanical Dimensions

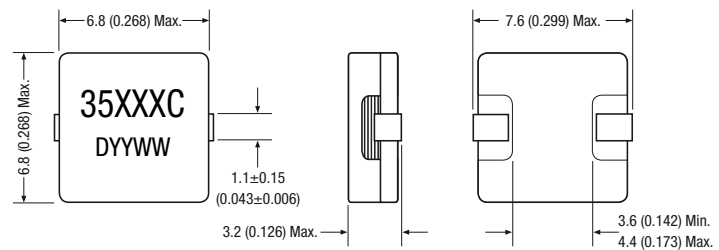

Package weight: 0.6g Typ.

### Recommended Footprint Details

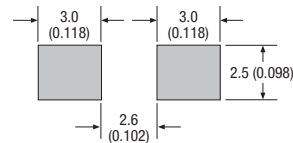

Unless otherwise stated, all dimensions in mm (inches) ± 0.25 (0.010).

Specifications typical at  $T_a = 25^\circ\text{C}$

<sup>1</sup> For further information, please visit [www.murata-ps.com/rohs](http://www.murata-ps.com/rohs)

<sup>2</sup> The maximum DC current is the value at which the inductance falls to 75% of its nominal value or when its temperature rise reaches 40°C, whichever is sooner.



For full details go to  
[www.murata-ps.com/rohs](http://www.murata-ps.com/rohs)

**INDUCTANCE Vs CURRENT**

35152C  
Typical performance characteristics

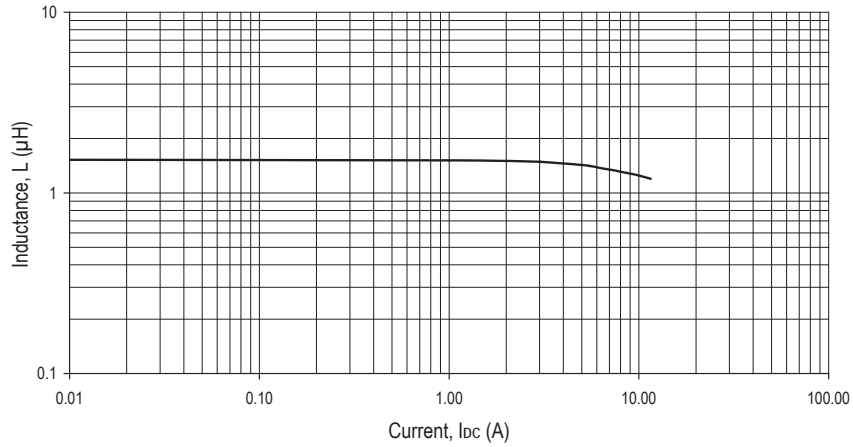

**TEMPERATURE Vs CURRENT**

35152C  
Typical performance characteristics

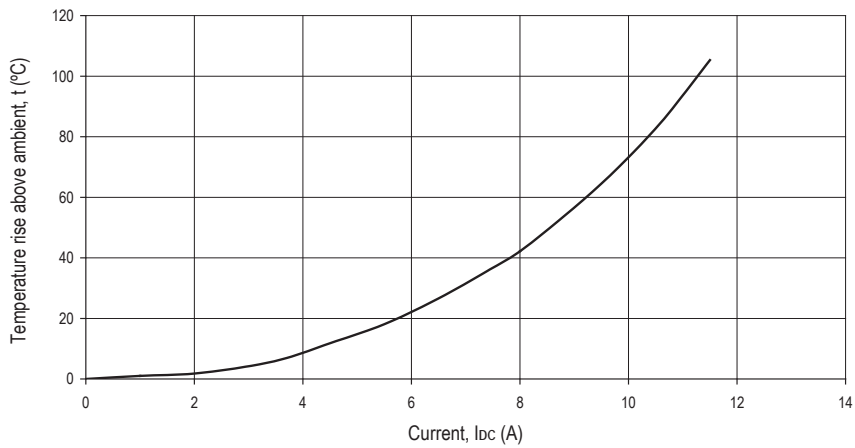

**INDUCTANCE Vs FREQUENCY**

35152C  
Typical performance characteristics

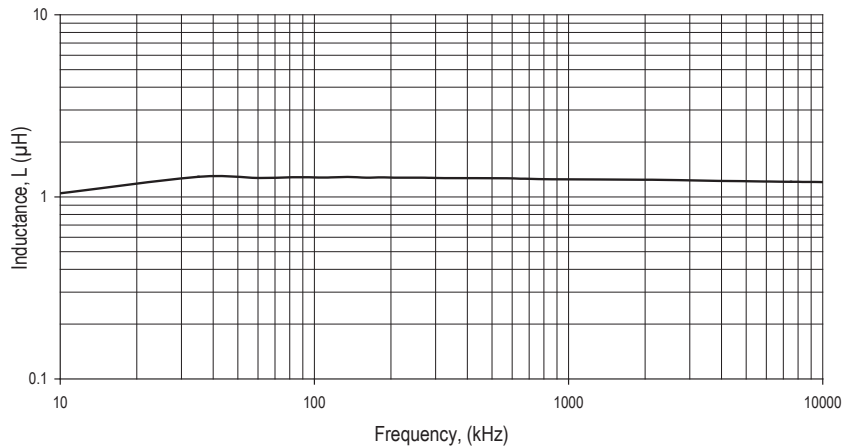

**PACKAGE SPECIFICATIONS**

**Mechanical Dimensions**

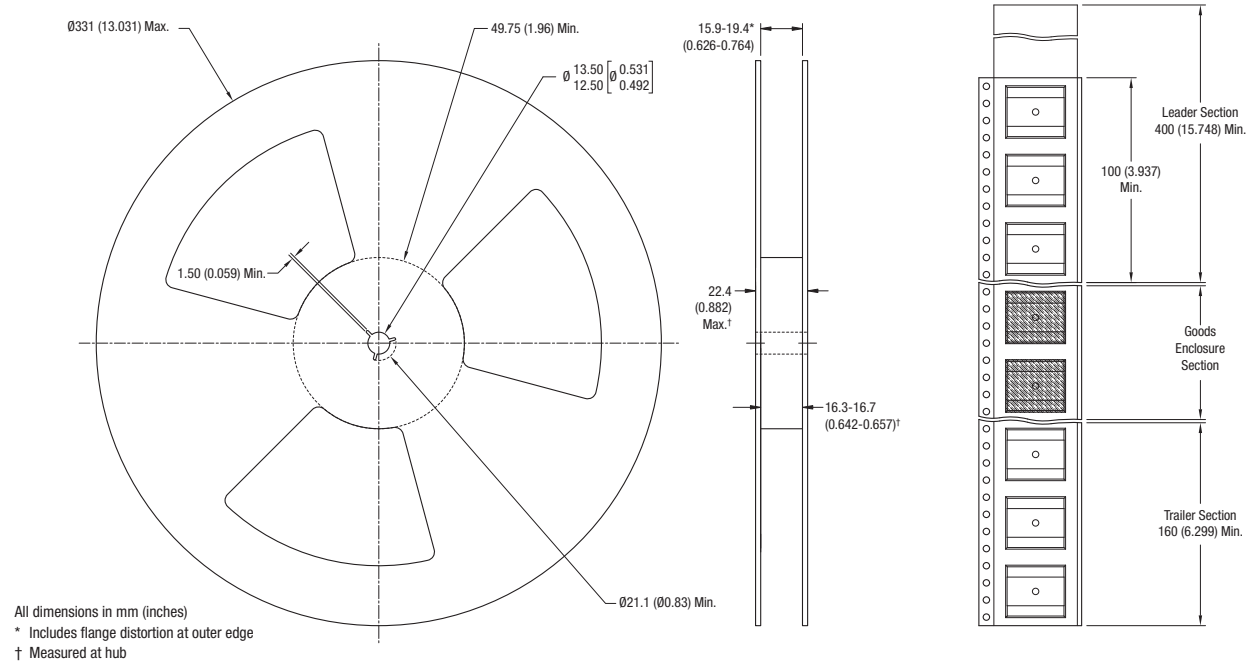

**Tape Outline Dimensions**

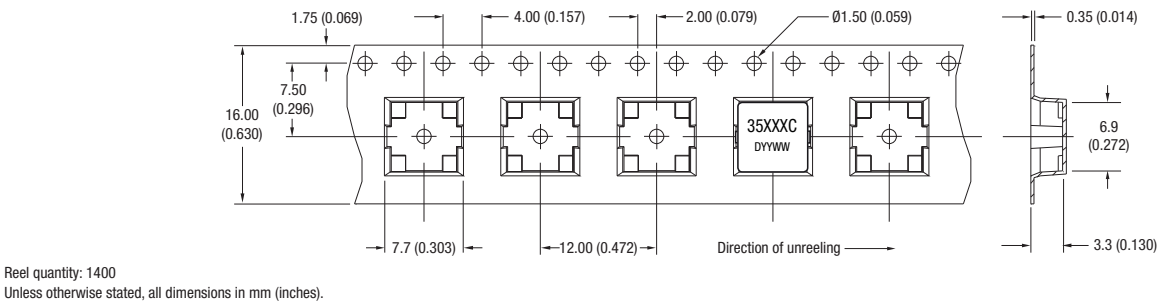

Murata Power Solutions, Inc.  
 11 Cabot Boulevard, Mansfield, MA 02048-1151 U.S.A.  
 ISO 9001 and 14001 REGISTERED

Murata Power Solutions, Inc. makes no representation that the use of its products in the circuits described herein, or the use of other technical information contained herein, will not infringe upon existing or future patent rights. The descriptions contained herein do not imply the granting of licenses to make, use, or sell equipment constructed in accordance therewith. Specifications are subject to change without notice.  
 © 2018 Murata Power Solutions, Inc.