

### **Rochester Electronics Manufactured Components**

Rochester branded components are manufactured using either die/wafers purchased from the original suppliers or Rochester wafers recreated from the original IP. All recreations are done with the approval of the OCM.

Parts are tested using original factory test programs or Rochester developed test solutions to guarantee product meets or exceed the OCM data sheet.

### **Quality Overview**

- ISO-9001
- AS9120 certification
- Qualified Manufacturers List (QML) MIL-PRF-35835
  - Class Q Military
  - Class V Space Level
- Qualified Suppliers List of Distributors (QSLD)
  - Rochester is a critical supplier to DLA and meets all industry and DLA standards.

Rochester Electronics, LLC is committed to supplying products that satisfy customer expectations for quality and are equal to those originally supplied by industry manufacturers.

The original manufacturer's datasheet accompanying this document reflects the performance and specifications of the Rochester manufactured version of this device. Rochester Electronics guarantees the performance of its semiconductor products to the original OEM specifications. 'Typical' values are for reference purposes only. Certain minimum or maximum ratings may be based on product characterization, design, simulation, or sample testing.

**SN54107, SN54LS107A,  
SN74107, SN74LS107A  
DUAL J-K FLIP-FLOPS WITH CLEAR**

DECEMBER 1983 - REVISED MARCH 1988

- Package Options Include Plastic "Small Outline" Packages, Ceramic Chip Carriers, and Plastic and Ceramic DIPs
- Dependable Texas Instruments Quality and Reliability

**description**

The '107 contain two independent J-K flip-flops with individual J-K, clock, and direct clear inputs. The '107 is a positive pulse-triggered flip-flop. The J-K input data is loaded into the master while the clock is high and transferred to the slave and the outputs on the high-to-low clock transition. For these devices the J and K inputs must be stable while the clock is high.

The 'LS107A' contain two independent negative-edge-triggered flip-flops. The J and K inputs must be stable prior to the high-to-low clock transition for predictable operation. When the clear is low, it overrides the clock and data inputs forcing the Q output low and the  $\bar{Q}$  output high.

The SN54107 and the SN54LS107A are characterized for operation over the full military temperature range of -55°C to 125°C. The SN74107 and the SN74LS107A are characterized for operation from 0°C to 70°C.

SN54107, SN54LS107A . . . J PACKAGE  
SN74107 . . . N PACKAGE  
SN74LS107A . . . D OR N PACKAGE  
(TOP VIEW)

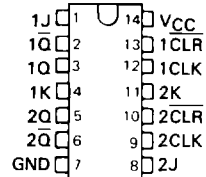

SN54LS107A . . . FK PACKAGE  
(TOP VIEW)

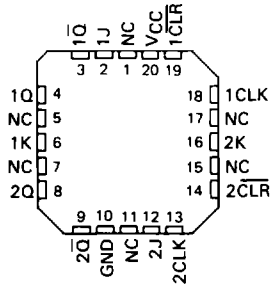

NC - No internal connection

'107  
FUNCTION TABLE

INPUTS				OUTPUTS	
CLR	CLK	J	K	Q	$\bar{Q}$
L	X	X	X	L	H
H	$\downarrow$	L	L	$Q_0$	$\bar{Q}_0$
H	$\downarrow$	H	L	H	L
H	$\downarrow$	L	H	L	H
H	$\downarrow$	H	H	TOGGLE	

'LS107A  
FUNCTION TABLE

INPUTS				OUTPUTS	
CLR	CLK	J	K	Q	$\bar{Q}$
L	X	X	X	L	H
H	$\downarrow$	L	L	$Q_0$	$\bar{Q}_0$
H	$\downarrow$	H	L	H	L
H	$\downarrow$	L	H	L	H
H	$\downarrow$	H	H	TOGGLE	
H	H	X	X	$Q_0$	$\bar{Q}_0$

PRODUCTION DATA documents contain information current as of publication date. Products conform to specifications per the terms of Texas Instruments standard warranty. Production processing does not necessarily include testing of all parameters.



POST OFFICE BOX 655012 • DALLAS, TEXAS 75265

**2**  
TTL Devices

**SN54107, SN54LS107A,  
SN74107, SN74LS107A  
DUAL J-K FLIP-FLOPS WITH CLEAR**

logic diagrams (positive logic)

'107

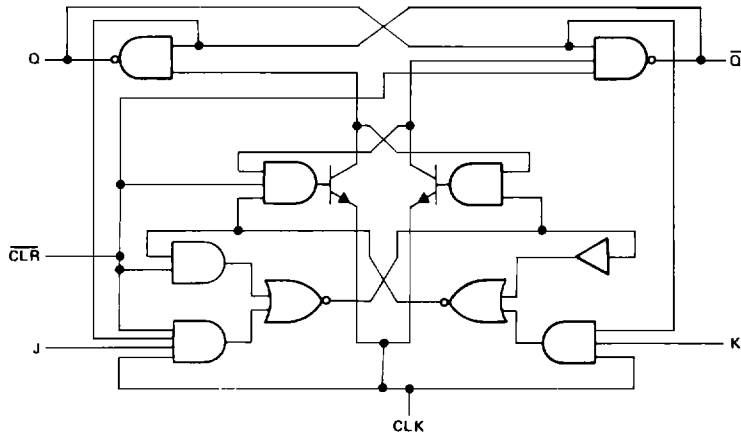

'LS107A

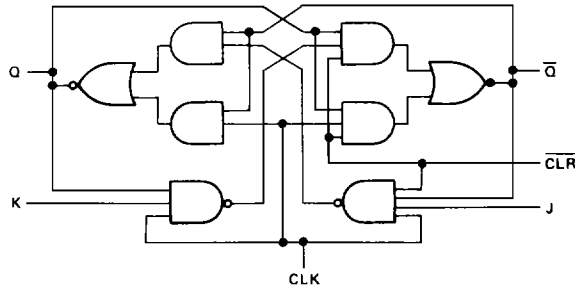

**2**  
TTL Devices

**SN54107, SN54LS107A,  
SN74107, SN74LS107A  
DUAL J-K FLIP-FLOPS WITH CLEAR**

**logic symbols †**

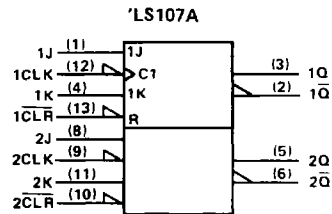
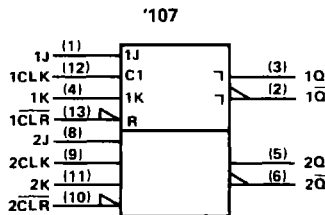

†These symbols are in accordance with ANSI/IEEE Std 91-1984 and IEC Publication 617-12. Pin numbers shown are for D, J, and N packages.

**schematic of inputs and outputs ‡**

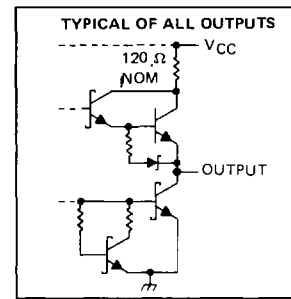
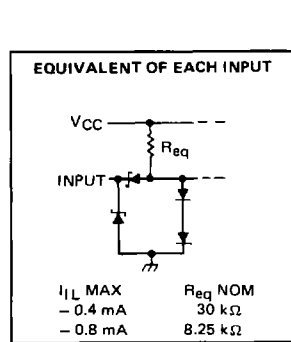
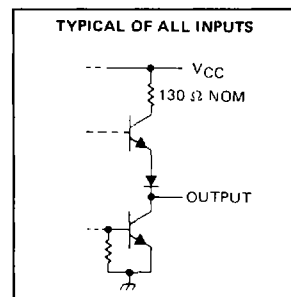
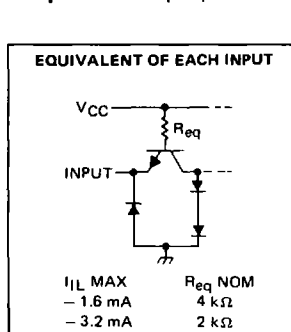

**absolute maximum ratings over operating free-air temperature range (unless otherwise noted)**

Supply voltage, $V_{CC}$ (see Note 1) .....	7 V
Input voltage: '107 .....	5.5 V
'LS107A .....	7 V
Operating free-air temperature range: SN54' .....	-55°C to 125°C
SN74' .....	0°C to 70°C
Storage temperature range .....	-65°C to 150°C

NOTE 1: Voltage values are with respect to network ground terminal.

**2**  
TTL Devices

# SN54107, SN74107 DUAL J-K FLIP-FLOPS WITH CLEAR

## recommended operating conditions

	SN54107			SN74107			UNIT
	MIN	NOM	MAX	MIN	NOM	MAX	
$V_{CC}$ Supply voltage	4.5	5	5.5	4.75	5	5.25	V
$V_{IH}$ High-level input voltage	2			2			V
$V_{IL}$ Low-level input voltage				0.8			V
$I_{OH}$ High-level output current				-0.4			mA
$I_{OL}$ Low-level output current				16			mA
$t_w$ Pulse duration	CLK high		20	20		ns	
	CLK low		47	47			
	CLR low		25	25			
$t_{su}$ Input setup time before CLK*	0			0			ns
$t_h$ Input hold time-data after CLK†	0			0			ns
$T_A$ Operating free-air temperature	-55		125	0		70	°C

## electrical characteristics over recommended operating free-air temperature range (unless otherwise noted)

2

TTL Devices

PARAMETER	TEST CONDITIONS†	SN54107		SN74107		UNIT
		MIN	TYP‡	MAX	MIN	
$V_{IK}$	$V_{CC} = \text{MIN}, I_I = -12 \text{ mA}$	-1.5		-1.5		V
$V_{OH}$	$V_{CC} = \text{MIN}, V_{IH} = 2 \text{ V}, V_{IL} = 0.8 \text{ V}, I_{OH} = -0.4 \text{ mA}$	2.4	3.4	2.4	3.4	V
$V_{OL}$	$V_{CC} = \text{MIN}, V_{IH} = 2 \text{ V}, V_{IL} = 0.8 \text{ V}, I_{OL} = 16 \text{ mA}$	0.2	0.4	0.2	0.4	V
$I_I$	$V_{CC} = \text{MAX}, V_I = 5.5 \text{ V}$	1		1		mA
$I_{IH}$	J or K	40		40		µA
	All other	80		80		
$I_{IL}$	J or K	-1.6		-1.6		mA
	All other	-3.2		-3.2		
$I_{OS}‡$	$V_{CC} = \text{MAX}$	-20	-57	-18	-57	mA
$I_{CC}†$	$V_{CC} = \text{MAX}, \text{ See Note 2}$	10	20	10	20	mA

†For conditions shown as MIN or MAX, use the appropriate value specified under recommended operating conditions.

‡All typical values are at  $V_{CC} = 5 \text{ V}, T_A = 25^\circ \text{C}$

§Not more than one output should be shorted at a time

¶Average per flip-flop

NOTE 2: With all outputs open,  $I_{CC}$  is measured with the Q and  $\bar{Q}$  outputs high in turn. At the time of measurement, the clock input is grounded.

## switching characteristics, $V_{CC} = 5 \text{ V}, T_A = 25^\circ \text{C}$ (see note 3)

PARAMETER	FROM (INPUT)	TO (OUTPUT)	TEST CONDITIONS		MIN	TYP	MAX	UNIT
$f_{max}$			$R_L = 400 \Omega, C_L = 15 \text{ pF}$		15	20		MHz
$t_{PLH}$	$\overline{CLR}$	$\bar{Q}$			16	25	ns	
$t_{PHL}$		Q			25	40	ns	
$t_{PLH}$	CLK	Q or $\bar{Q}$			16	25	ns	
$t_{PHL}$					25	40	ns	

NOTE 3: Load circuits and voltage waveforms are shown in Section 1

# SN54LS107A, SN74LS107A DUAL J-K FLIP-FLOPS WITH CLEAR

## recommended operating conditions

		SN54LS107A			SN74LS107A			UNIT
		MIN	NOM	MAX	MIN	NOM	MAX	
V <sub>CC</sub>	Supply voltage	4.5	5	5.5	4.75	5	5.25	V
V <sub>IH</sub>	High-level input voltage	2			2			V
V <sub>IL</sub>	Low-level input voltage			0.7			0.8	V
I <sub>OH</sub>	High-level output current			-0.4			0.4	mA
I <sub>OL</sub>	Low-level output current			4			8	mA
f <sub>clock</sub>	Clock frequency	0		30	0		30	MHz
t <sub>w</sub>	Pulse duration	CLK high			20			ns
		CLR low	25		25			
t <sub>su</sub>	Setup time before CLK ↓	data high or low	20		20			ns
		CLR inactive	25		25			
t <sub>h</sub>	Hold time data after CLK ↓	0			0			ns
T <sub>A</sub>	Operating free-air temperature	-55		125	0		70	°C

## electrical characteristics over recommended operating free-air temperature range (unless otherwise noted)

PARAMETER		TEST CONDITIONS†		SN54LS107A		SN74LS107A		UNIT
				MIN	TYP‡	MAX	MIN	
V <sub>IK</sub>		V <sub>CC</sub> = MIN,	I <sub>I</sub> = -18 mA	-1.5		-1.5		V
V <sub>OH</sub>		V <sub>CC</sub> = MIN, I <sub>OH</sub> = -0.4 mA	V <sub>IH</sub> = 2 V, V <sub>IL</sub> = MAX,	2.5	3.4	2.7	3.4	V
V <sub>OL</sub>		V <sub>CC</sub> = MIN, I <sub>OL</sub> = 4 mA	V <sub>IL</sub> = MAX, V <sub>IH</sub> = 2 V,	0.25	0.4	0.25	0.4	V
		V <sub>CC</sub> = MIN, I <sub>OL</sub> = 8 mA	V <sub>IL</sub> = MAX, V <sub>IH</sub> = 2 V,			0.35	0.5	
I <sub>I</sub>	J or K	V <sub>CC</sub> = MAX,	V <sub>I</sub> = 7 V	0.1		0.1		mA
	CLR			0.3		0.3		
	CLK			0.4		0.4		
I <sub>IH</sub>	J or K	V <sub>CC</sub> = MAX,	V <sub>I</sub> = 2.7 V	20		20		μA
	CLR			60		60		
	CLK			80		80		
I <sub>IL</sub>	J or K	V <sub>CC</sub> = MAX,	V <sub>I</sub> = 0.4 V	-0.4		-0.4		mA
	CLR or CLK			-0.8		-0.8		
I <sub>OS</sub> §		V <sub>CC</sub> = MAX,	See Note 4	-20	-100	-20	-100	mA
I <sub>CC</sub> (Total)		V <sub>CC</sub> = MAX,	See Note 2	4	6	4	6	mA

† For conditions shown as MIN or MAX, use the appropriate value specified under recommended operating conditions.

‡ All typical values are at V<sub>CC</sub> = 5 V, T<sub>A</sub> = 25°C.

§ Not more than one output should be shorted at a time, and the duration of the short circuit should not exceed one second.

NOTE 2 With all outputs open, I<sub>CC</sub> is measured with the Q and  $\bar{Q}$ , outputs high in turn. At the time of measurement, the clock input is grounded.

NOTE 4 For certain devices where state commutation can be caused by shorting an output to ground, an equivalent test may be performed with V<sub>O</sub> = 2.25 V and 2.125 V for the 54 family and the 74 family, respectively, with the minimum and maximum limits reduced to one half of their stated values.

## switching characteristics, V<sub>CC</sub> = 5 V, T<sub>A</sub> = 25°C (see note 3)

PARAMETER	FROM (INPUT)	TO (OUTPUT)	TEST CONDITIONS		MIN	TYP	MAX	UNIT
f <sub>max</sub>			R <sub>L</sub> = 2 kΩ,	C <sub>L</sub> = 15 pF	30	45		MHz
t <sub>PLH</sub>	$\bar{CLR}$ or CLK	Q or $\bar{Q}$			15	20		ns
t <sub>PHL</sub>					15	20		ns

NOTE 3: Load circuits and voltage waveforms are shown in Section 1.

# 2

## TTL Devices