

# 3mm LED CBI® Circuit Board Indicator DIN 41494 Bi-Level

# Dialight

## 553-xxxx-400

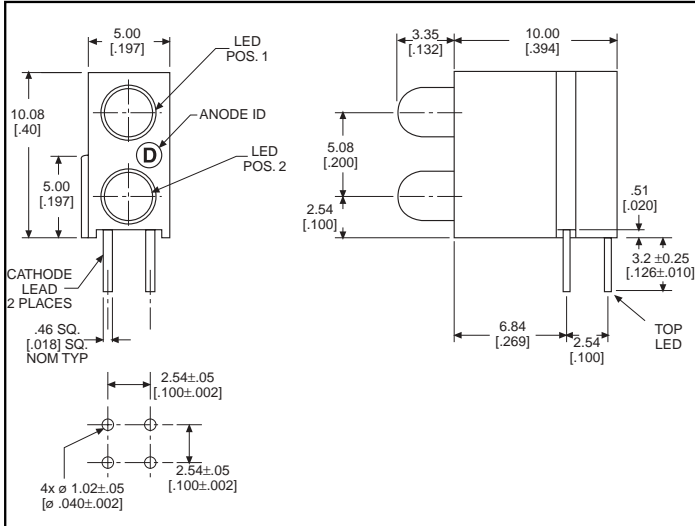

Standard Polarity shown in drawing: Cathode left

### Features

- Designed to accommodate DIN 41494
- Multiple CBIs form horizontal LED arrays on 5.0mm (0.197") center-lines.
- High Contrast, UL 94 V-0 rated, black housing
- Oxygen index: 32%
- Polymer content: PBT, 0.542 g
- Housing stand-offs facilitate PCB cleaning
- Solderability per MIL-STD-202F, method 208F
- LEDs are safe for direct viewing per IEC 825-1, EN-60825-1

### Tolerance note: As noted, otherwise:

- LED Protrusion:  $\pm 0.04$  mm [ $\pm 0.016$ ]
- CBI Housing:  $\pm 0.02$ mm [ $\pm 0.008$ ]

### Custom Combinations

- Contact factory for information on custom bi-level arrays and color combinations.

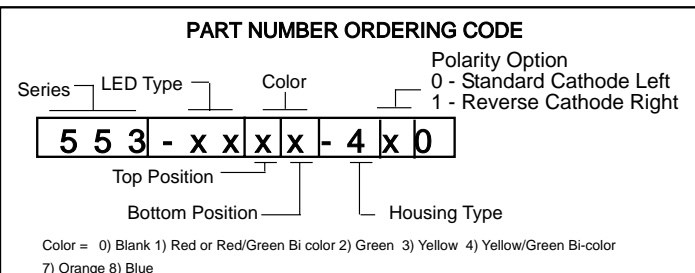

### PART NO.

#### HIGH EFFICIENCY - LED TYPE 01

- 553-0111-400
- 553-0122-400
- 553-0133-400
- 553-0188-400

### COLOR\*

- Red
- Green
- Yellow
- Blue<sup>3</sup>



#### LOW CURRENT - LED TYPE 02

- 553-0211-400
- 553-0222-400
- 553-0233-400

- Red
- Green
- Yellow

#### RESISTOR 5 VOLTS - LED TYPE 03

- 553-0311-400
- 553-0322-400
- 553-0333-400

- Red
- Green
- Yellow

#### BI-COLOR - LED TYPE 07

- 553-0711-400
- 553-0744-400

- Red/Green
- Yellow/Green

#### NON-DIFFUSED - LED TYPE 22

- 553-2211-400
- 553-2222-400
- 553-2233-400

- Red
- Green
- Yellow

\* Top-Bottom LED

### REVERSE POLARITY OPTION AVAILABLE

See Part Number Ordering Code below.



**ATTENTION**  
OBSERVE PRECAUTIONS  
FOR HANDLING  
ELECTROSTATIC  
SENSITIVE  
DEVICES

# 553-xxxx-400

(DIN 41494 compatible)

## Typical Operating Characteristics ( $T_A=25^{\circ}\text{C}$ )

See LED data sheet for additional information  
See page 4-70 and 4-71 for Reference Only LED Drive Circuit Examples. See page 4-72 for Pin Out

### HIGH EFFICIENCY

Part Number	Color	Peak Wavelength nm	$I_V$ mcd	$V_F$ Volts	Test Current (mA)	Viewing Angle $2\Theta_{\%}$	LED Data sheet	Page #
553-0111-400	Red	635	10	2*	10	60°	521-9216	4-58
553-0122-400	Green	565	12.6	2.1*	10	60°	521-9210	4-58
553-0133-400	Yellow	585	10	2.1*	10	60°	521-9211	4-58
553-0177-400	Orange	600	7	2.2	10	60°	521-9498	4-58
553-0188-400	Blue	428	12	3.5	10	70°	521-9831	4-57

\*  $I_F=20\text{mA}$

### LOW CURRENT

Part Number	Color	Peak Wavelength nm	$I_V$ mcd	$V_F$ Volts	Test Current (mA)	Viewing Angle $2\Theta_{\%}$	LED Data sheet	Page #
553-0211-400	Red	635	1.6	1.7	2	60°	521-9324	4-60
553-0222-400	Green	565	1.6	1.9	2	60°	521-9326	4-60
553-0233-400	Yellow	585	1.6	1.8	2	60°	521-9325	4-60

### INTEGRAL RESISTOR, 5 VOLTS

Part Number	Color	Peak Wavelength nm	$I_V$ mcd	Test Voltage	Forward Current (mA)	Viewing Angle $2\Theta_{\%}$	LED Data sheet	Page #
553-0311-400	Red	635	29	5	10	60°	521-9215	4-59
553-0322-400	Green	565	19	5	10	60°	521-9323	4-59
553-0333-400	Yellow	585	12.6	5	10	60°	521-9322	4-59

### BI-COLOR

Part Number	Color	Peak Wavelength nm	$I_V$ mcd	$V_F$ Volts	Test Current (mA)	Viewing Angle $2\Theta_{\%}$	LED Data sheet	Page #
553-0711-400	Red/Green	635/565	4.7/10	2/2.1	10	50°	521-9459	4-63
553-0744-400	Yellow/Green	585/565	4.3/6.3	2.1*/2.1*	10	80°	521-9478	4-62

\*  $I_F = 20\text{mA}$

### NON-DIFFUSED

Part Number	Color	Peak Wavelength nm	$I_V$ mcd	$V_F$ Volts*	Test Current (mA)	Viewing Angle $2\Theta_{\%}$	LED Data sheet	Page #
553-2211-400	Red	635	29	2	10	45°	521-9432	4-61
553-2222-400	Green	565	50	2.1	10	45°	521-9430	4-61
553-2233-200	Yellow	585	20	2.1	10	45°	521-9431	4-61

\*  $I_F = 20\text{mA}$

### CBI ARRAYS .200 PITCH

Dialight offers its Multiarray to reduce insertions and to assure indicator alignment. Multiarrays mount indicators on .200 centers. These assemblies are available in arrays of 2 to 6. See pages 4-41 and 4-42 for information. Call factory for information on .185 pitched arrays.





# 3mm Discrete LED Tinted, Diffused

# Dialight

## 521-9831



**PART NO.** 521-9831  
**COLOR** Blue<sup>3</sup>

**MOUNTING CLIP:** 515-0006  
located on page 4-65



**4**

### ABSOLUTE MAXIMUM RATINGS (T<sub>A</sub>=25°C)

Blue  
-9831

Power Dissipation (mW)	100
Forward Current (mA)	20
Derating (mA/°C) From 55°C	.44
Operating Temperature (°C)	-40/+100
Storage Temperature (°C)	-40/+100
Soldering Temperature	260°C, 5 seconds, 1.6 mm from case

Solder Adherence per MIL-STD-202E, Method 208C

### OPERATING CHARACTERISTICS (T<sub>A</sub>=25°C)

Blue  
-9831

Luminous Intensity (mcd)	Min.	6.3
I <sub>F</sub> =10mA	Typical	12
Peak Wavelength (nm)	Typical	428
λ Peak		
Viewing Angle (2Θ <sub>1/2</sub> )	Typical	70°
Forward Voltage (V)	Typical	3.5
I <sub>F</sub> =10mA	Max.	4.2
Reverse Voltage (V) IR=10μA	Min.	3

Θ<sub>1/2</sub> is the off axis angle at which the luminous intensity is half the axial luminous intensity

# 3mm Discrete LED

## High Efficiency

## Diffused

# 521-9210, -9211, -9216, -9498, -9636

# Dialight

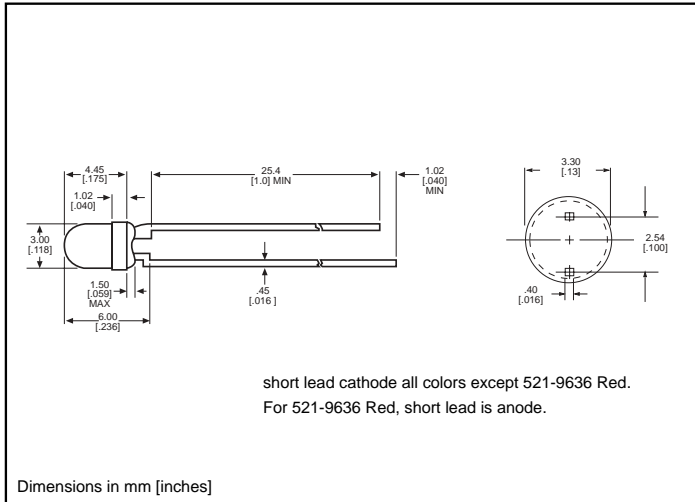

### PART NO. COLOR

- 521-9210 Green
- 521-9211 Yellow
- 521-9216 Red
- 521-9498 Orange
- 521-9636 Red



**MOUNTING CLIP: 515-0006**  
located on page 4-65

<b>ABSOLUTE MAXIMUM RATINGS</b> ( $T_A=25^\circ\text{C}$ )	Green <b>-9210</b>	Yellow <b>-9211</b>	Red <b>-9216</b>	Orange <b>-9498</b>	Red <b>-9636</b>
Power Dissipation (mW)	100	60	100	135	100
Forward Current (mA)	30	20	30	25	40
Derating (mA/°C) From 50°C <sup>1</sup> from 25°C	.4	.25	.4	.5	.5 <sup>1</sup>
Operating Temperature (°C)	-55/+100	-55/+100	-55/+100	-55/+100	-55/+100
Storage Temperature (°C)	-55/+100	-55/+100	-55/+100	-55/+100	-55/+100
Soldering Temperature	260°C, 5 seconds, 1.6 mm from body				

Solder Adherence per MIL-STD-202E, Method 208C

<b>OPERATING CHARACTERISTICS</b> ( $T_A=25^\circ\text{C}$ )		Green <b>-9210</b>	Yellow <b>-9211</b>	Red <b>-9216</b>	Orange <b>-9498</b>	Red <b>-9636</b>
Luminous Intensity (mcd)	Min.	4.7	7.4	7.4	3.4	8.7 <sup>1</sup>
	Typical	12.6	10	10	7	48 <sup>1</sup>
Peak Wavelength (nm)	Typical	565	585	635	600	660
Viewing Angle ( $2\theta$ °)	Typical	60°	60°	60°	60°	60°
Forward Voltage (V)	Typical	2.1 <sup>1</sup>	2.1 <sup>1</sup>	2 <sup>1</sup>	2.2	1.8 <sup>1</sup>
	Max.	2.8 <sup>1</sup>	2.8 <sup>1</sup>	2.8 <sup>1</sup>	3	2.4 <sup>1</sup>
Reverse Voltage (V), $I_R=100\mu\text{A}$	Max.	5	5	5	5	4

<sup>1</sup>  $\theta$  is the off axis angle at which the luminous intensity is half the axial luminous intensity

**3mm Discrete LED  
Integral Resistor, 5V  
Diffused**

**Dialight**

**521-9215, -9322, -9323**



PART NO.	COLOR
521-9215	Red
521-9322	Yellow
521-9323	Green

**MOUNTING CLIP:** 515-0006  
located on page 4-65

<b>ABSOLUTE MAXIMUM RATINGS</b> ( $T_A=25^\circ\text{C}$ )	Red	Yellow	Green
	<b>-9215</b>	<b>-9322</b>	<b>-9323</b>
Forward Voltage (V)	7.5	7.5	7.5
Derating ( $V/^\circ\text{C}$ ) From $50^\circ\text{C}$	.086	.086	.071
Operating Temperature ( $^\circ\text{C}$ )	-40/+85	-40/+85	-20/+85
Storage Temperature ( $^\circ\text{C}$ )	-55/+100	-55/+100	-55/+100
Soldering Temperature	260 $^\circ\text{C}$ , 5 seconds, 1.6 mm from case		

Solder Adherence per MIL-STD-202E, Method 208C

<b>OPERATING CHARACTERISTICS</b> ( $T_A=25^\circ\text{C}$ )		Red	Yellow	Green
		<b>-9215</b>	<b>-9322</b>	<b>-9323</b>
Luminous Intensity (mcd)	Min.	8.7	3.7	5.6
	Typical	29	12.6	19
Peak Wavelength (nm)	Typical	635	585	565
Viewing Angle ( $2\theta_{1/2}$ )	Typical	60 $^\circ$	60 $^\circ$	60 $^\circ$
Forward Current (mA)	Typical	10	10	10
	Max.	20	20	20
Reverse Voltage (V), $I_R=100\mu\text{A}$	Min.	5	5	5

$\theta_{1/2}$  is the off axis angle at which the luminous intensity is half the axial luminous intensity

**4**

# 3mm Discrete LED

## Low Current

## Diffused

# Dialight

## 521-9324, -9325, -9326

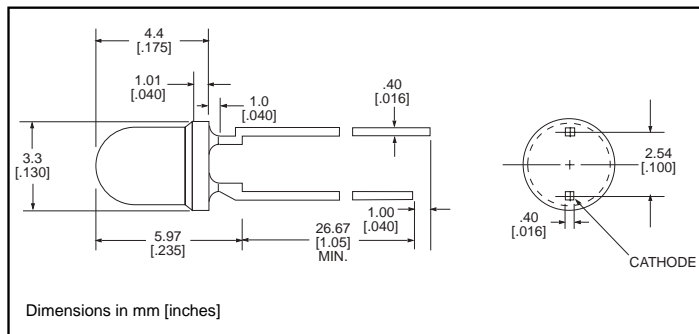

### PART NO. COLOR

521-9324	Red
521-9325	Yellow
521-9326	Green

**MOUNTING CLIP:** 515-0006  
located on page 4-65

### ABSOLUTE MAXIMUM RATINGS (T<sub>A</sub>=25°C)

	Red -9324	Yellow -9325	Green -9326
Power Dissipation (mW)	20	20	20
Forward Current (mA)	7	7	7
Derating (mA/°C) From 90°C	.7	.7	.7
Peak Current (mA) Pulse width = 10 μs	500	500	500
Operating Temperature (°C)	-55/+100	-55/+100	-55/+100
Storage Temperature (°C)	-55/+100	-55/+100	-55/+100
Soldering Temperature	260°C, 5 seconds, 1.6 mm from case		

Solder Adherence per MIL-STD-202E, Method 208C

### OPERATING CHARACTERISTICS (T<sub>A</sub>=25°C)

		Red -9324	Yellow -9325	Green -9326
Luminous Intensity (mcd) I <sub>F</sub> =2mA	Min.	1	1	1
	Typical	1.6	1.6	1.6
Peak Wavelength (nm) λ Peak	Typical	635	585	565
Viewing Angle (2Θ °)	Typical	60°	60°	60°
Forward Voltage (V) I <sub>F</sub> =2mA	Typical	1.7	1.8	1.9
	Max.	2.2	2.7	2.2
Reverse Voltage (V), I <sub>R</sub> =50μA	Min.	5	5	5

Θ is the off axis angle at which the luminous intensity is half the axial luminous intensity

**3mm Discrete LED**  
**High Efficiency**  
**Tinted, Non-Diffused**

**Dialight**

**521-9430, -9431, -9432**

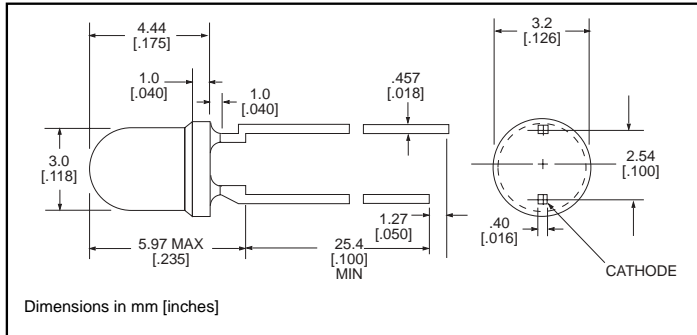

**PART NO.**

**COLOR**

521-9430  
 521-9431  
 521-9432

Green  
 Yellow  
 Red

**MOUNTING CLIP: 515-0006**  
 located on page 4-65

**ABSOLUTE MAXIMUM RATINGS** ( $T_A=25^\circ\text{C}$ )

	Green <b>-9430</b>	Yellow <b>-9431</b>	Red <b>-9432</b>
Power Dissipation (mW)	100	60	100
Forward Current (mA)	30	20	30
Derating (mA/°C) From 50°C	.4	.25	.4
Peak Current (mA) Pulse width = 100µs	120	80	120
Operating Temperature (°C)	-55/+100	-55/+100	-55/+100
Storage Temperature (°C)	-55/+100	-55/+100	-55/+100
Soldering Temperature	260°C, 5 seconds, 1.6 mm from case		

Solder Adherence per MIL-STD-202E, Method 208C

**OPERATING CHARACTERISTICS** ( $T_A=25^\circ\text{C}$ )

		Green <b>-9430</b>	Yellow <b>-9431</b>	Red <b>-9432</b>
Luminous Intensity (mcd) $I_F=10\text{mA}$	Min.	32	10	8.7
	Typical	50	20	29
Peak Wavelength (nm) $\lambda$ Peak	Typical	565	585	635
Viewing Angle ( $2\theta_{1/2}$ )	Typical	45°	45°	45°
Forward Voltage (V) $I_F=20\text{mA}$	Typical	2.1	2.1	2
	Max.	2.8	2.8	2.8

$\theta_{1/2}$  is the off axis angle at which the luminous intensity is half the axial luminous intensity

**4**

# 3mm Discrete LED

## Bi-Color

### Non-Tinted, Diffused



# 521-9478, -9628, -9768

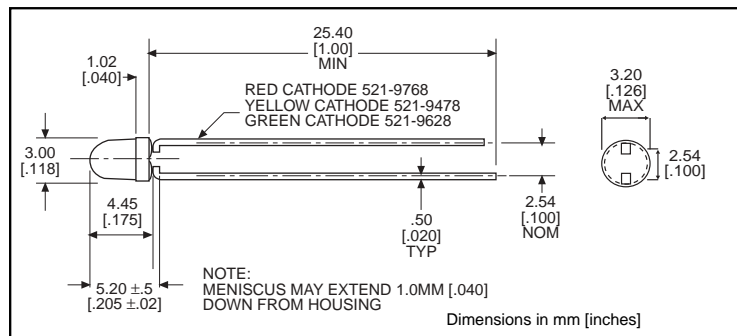

PART NO.	COLOR
521-9478	Yellow/Green
521-9628	Red/Green
521-9768	Red/Yellow

**MOUNTING CLIP: 515-0006**  
located on page 4-65

<b>ABSOLUTE MAXIMUM RATINGS</b> ( $T_A=25^\circ\text{C}$ )	Yellow/Green <b>-9478</b>	Red/Green <b>-9628</b>	Red/Yellow <b>-9768</b>
Power Dissipation (mW)	60/100	140/100	100/60
Forward Current (mA)	20/30	40/30	30/20
Derating (mA/°C) From 25°C From 50°C	.25 <sup>1</sup> /.40 <sup>1</sup>	.5/.4	.4 <sup>1</sup> /.25 <sup>1</sup>
Peak Current (mA) Pulse width = 10µs	80/120	200/120	120/80
Operating Temperature (°C)	-55/+100	-55/+100	-55/+100
Storage Temperature (°C)	-55/+100	-55/+100	-55/+100
Soldering Temperature	260°C, 5 seconds, 1.66 mm from case		

Solder Adherence per MIL-STD-202E, Method 208C

<b>OPERATING CHARACTERISTICS</b> ( $T_A=25^\circ\text{C}$ )		Yellow/Green <b>-9478</b>	Red/Green <b>-9628</b>	Red/Yellow <b>-9768</b>
Luminous Intensity (mcd)	Min.	2.5/2.5	3.7*/1.1*	1.7*/1.7*
	Typical	4.3/6.3	12.6*/3.7*	5.6*/5.6*
Peak Wavelength (nm) $\lambda$ Peak	Typical	585/565	660/565	630/585
Viewing Angle ( $2\theta$ °)	Typical	80°	200°	80°
Forward Voltage (V)	Typical	2.1/2.1	1.8/2.1	2/2.1
	Max.	2.8/2.8	2.4/2.8	2.8/2.8
Reverse Voltage (V) $I_R=100\text{ua}$	Min.	5	5	5

$\theta$  ° is the off axis angle at which the luminous intensity is half the axial luminous intensity



# 3mm Discrete LED Bi-Color Non-Tinted, Diffused

# Dialight

## 521-9459

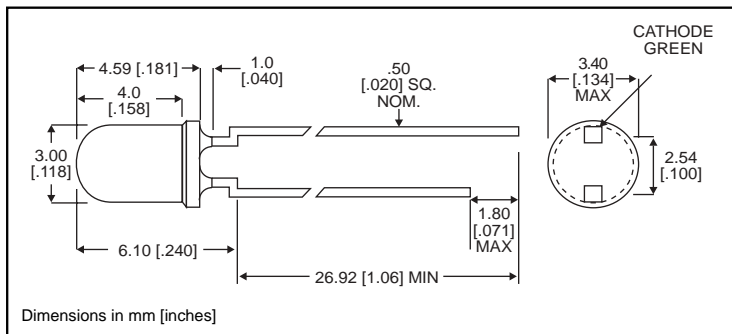

**PART NO.** 521-9459  
**COLOR** Red/Green

**MOUNTING CLIP:** 515-0006  
located on page 4-65

4

### ABSOLUTE MAXIMUM RATINGS (T<sub>A</sub>=25°C)

Red/Green  
**-9459**

Power Dissipation (mW)	140
Forward Current (mA)	45
Derating (mA/°C) From 25°C	.6
Peak Current (mA) Pulse width = 10μs	1000
Operating Temperature (°C)	-55/+100
Storage Temperature (°C)	-55/+100
Soldering Temperature	260°C, 5 seconds, 1.6 mm from case

Solder Adherence per MIL-STD-202E, Method 208C

### OPERATING CHARACTERISTICS (T<sub>A</sub>=25°C)

Red/Green  
**-9459**

Luminous Intensity (mcd) I <sub>F</sub> =10mA	Min. Typical	2.5/3.7 4.7/10
Peak Wavelength (nm) λ Peak	Typical	635/565
Viewing Angle (2Θ <sub>1/2</sub> )	Typical	50°
Forward Voltage (V) I <sub>F</sub> =10mA	Typical Max.	2/2.1 2.8/2.8

Θ<sub>1/2</sub> is the off axis angle at which the luminous intensity is half the axial luminous intensity