

GlobTek, Inc. www.globtek.com 186 Veterans Drive, Northvale, NJ 07647 Tel. (201) 784-1000 Fax (201) 784-0111	Drawing Title: GT-41062-1805-T3, ITE Power Supply, Efficiency Level: IV, Case Color/Style: GlobTek Black, Desktop/External, Regulated Switchmode AC-DC, Input Rating: 100-240V~, 50-60 Hz, IEC 60320/C14 , Output Rating: 18W, 5V@3.6A, Output Configuration: 1000 mm, 18/1C + Shield Cond, UL 1185, 5 Pin 180° Male DIN Plug or Equal, Ferrite: Core Size: 14.2*28.5*8.2, GlobTek Black, GT Cord # C3260, Pin Out: PIN 1,2:Common, Pin 4: N/C, Pin 3,5: +VDC, Shield: Common, Blades/Input Cord: Not Applicable, Approvals: C-Tick CB CCC CE GOST-R WEEE Ukraine IP40 Korea (12V Only) Korea (24V Only) NrCAN SIQ cUL VCCI Class I RoHS 2 China RoHS LPS Level IV PSE Korea (9V Only) Korea (15V Only) Level V PSE PSE IRAM	
	Model No. GT-41062-1805-T3	
	Part No. TR9CA3600N05NRG2336	Rev H

REVISION HISTORY

REV	DESCRIPTION	SUB	DATE	APPROVED
H	Change Master Carton Size to 463*318*305mm, change CQC-PSE to TUV-PSE and add IP40	QA	11/30/2015	QA

In Addition to GlobTek Inc.'s renewed ISO9001:2008 - Quality Management System Certification, GlobTek Inc. is now certified to:

ISO13485:2003 - Medical Devices Quality Management System Certification
 ISO14001:2004 - Environmental Management System Certification

ISO Certificates are available online at <http://www.globtek.com/iso-certificates/>

Customer Approval of Specification:

Please approve, sign and send back to GlobTek so we can complete order processing.

A delay in receipt of this form will delay delivery schedule.

Company Name:

Customer P/N:

Quote Number:

Date:

Authorized Representative Name:

Authorized Representative Signature:

The acceptance of this specification and use of the product described in this document indicates the acceptance and binding of the customer to Globtek terms and conditions, which supersede all other agreements, terms, and conditions (<http://en.globtek.com/terms-and-conditions/>).

Footnote:

GlobTek Inc. will not be liable for the safety and performance of these power supplies if unauthorized access and repair occurs. End user should consult applicable UL, CSA or EN standards for proper installation instruction.

Limitation of Use:

GlobTek product are not authorized for use as mission critical components in life support hazardous environment, nuclear or aircraft applications without prior written approval from the CEO of GlobTek Inc.

Contents of this document are subject to change without prior notice.

RELEASED

By N.Frost at 11:09 am, Jan 21, 2016

GT-41062-1805-T3, 18W, 5V@3.6A, Desktop/External, Regulated Switchmode AC-DC

GlobTek, Inc. www.globtek.com 186 Veterans Drive, Northvale, NJ 07647 Tel. (201) 784-1000 Fax (201) 784-0111	Drawing Title: GT-41062-1805-T3, ITE Power Supply, Efficiency Level: IV, Case Color/Style: GlobTek Black, Desktop/External, Regulated Switchmode AC-DC, Input Rating: 100-240V~, 50-60 Hz, IEC 60320/C14 , Output Rating: 18W, 5V@3.6A, Output Configuration: 1000 mm, 18/1C + Shield Cond, UL 1185, 5 Pin 180° Male DIN Plug or Equal, Ferrite: Core Size: 14.2*28.5*8.2, GlobTek Black, GT Cord # C3260, Pin Out: PIN 1,2:Common, Pin 4: N/C, Pin 3,5: +VDC, Shield: Common, Blades/Input Cord: Not Applicable, Approvals: C-Tick CB CCC CE GOST-R WEEE Ukraine IP40 Korea (12V Only) Korea (24V Only) NrCAN SIQ cUL VCCI Class I RoHS 2 China RoHS LPS Level IV PSE Korea (9V Only) Korea (15V Only) Level V PSE IRAM	
	Model No. GT-41062-1805-T3	
	Part No. TR9CA3600N05NRG2336	Rev H

POWER SUPPLY INFORMATION

TYPE: Desktop/External
TECHNOLOGY: Regulated Switchmode AC-DC
CASE COLOR: GlobTek Black
NAMEPLATE RATED INPUT: 100-240V~, 50-60 Hz, 0.6A
INPUT CONFIG: IEC 60320/C14
WATTS: 18.0
VOLTS OUT: 5
CURRENT OUT (Amps): 3.6
BLADE/CORD INCLUDED: N/A: Not Applicable
BLADE/CORD INSTALLED: N/A: Not Applicable
EFFICIENCY LEVEL: IV
OUTPUT CONFIGURATION: 1000 mm, 18/1C + Shield Cond, UL 1185, 5 Pin 180° Male DIN Plug or Equal, Ferrite: Core Size: 14.2*28.5*8.2, GlobTek Black, GT Cord # C3260
CONNECTOR PIN OUT: PIN 1,2:Common, Pin 4: N/C, Pin 3,5: +VDC, Shield: Common
LABEL SPECS: Standard GT,L-1462
PACK SPEC: TR9CA3600N05NRG2336

NOTES / DEVIATIONS:

DIMENSIONS ARE IN MM UNLESS SPECIFIED OTHERWISE.

ELECTRICAL SPECIFICATIONS

A) ELECTRICAL SPECIFICATIONS:

1. Input Voltage: Specified 90-264 Vac, Nameplate rated: 100-240Vac
2. Input Frequency: Specified 47-63 Hz, Nameplate rated 50-60Hz
3. Output Power (Rated): 18Watts max
4. Output Regulation: +/- 5% measured at the output connector
5. Line Voltage Regulation: +/- 1% typical measures at full load
6. Output Ripple (Vp-p): 1% or 150 mV whichever is greater measured at 20 MHz bandwidth with 0.1 uf ceramic capacitor in parallel with 10 uf electrolytic capacitor connected at the end of output connector at nominal line
7. Turn-On/Turn-Off Overshoot: 5% maximum, 1mS typical recovery time for 25% step load
8. Turn-On Delay: 1 second typical
09. Hold-Up Time: 8mS typical @ nominal input voltage & full load
10. Inrush Current: 30A typical @ 115Vac input ; 60A typical @ 230Vac input
11. Switching Frequency: 65 KHz typical

B) PROTECTION

1. Over-Voltage: Protected via zener diode across the output
2. Short Circuit: Electronically Protected, unit will recover upon removal of fault
3. Input Protection: Input line fusing

C) SAFETY

1. Dielectric Withstand Voltage: 4242Vdc from primary to secondary
2. Touch Current: <0.25mA @ 240Vac input voltage
3. Earth Leakage Current: <3.5mA @ 240Vac input voltage
4. ROHS 2: Complies with EU 2011/65/EU and China SJ/T 11363-2006
4. Earth continuity test:<0.1 Ohm or < 0.2 Ohm when with a non-detachable Power Supply cord, Class I Only

D) OTHER:

PROPRIETARY INFORMATION

PROPRIETARY OF GLOBTEK, INC. ANY REPRODUCTION, DISCLOSURE OR USE OF THIS DRAWING, IN WHOLE OR IN PART, IS HEREBY PROHIBITED EXCEPT AS SPECIFIED IN WRITING BY GLOBTEK, INC.

QA /01/21/2016 10:12:03 AM

GlobTek, Inc.
www.globtek.com
186 Veterans Drive,
Northvale, NJ 07647
Tel. (201) 784-1000
Fax (201) 784-0111

Drawing Title: GT-41062-1805-T3, ITE Power Supply, Efficiency Level: IV, Case Color/Style: GlobTek Black, Desktop/External, Regulated Switchmode AC-DC, Input Rating: 100-240V~, 50-60 Hz, IEC 60320/C14 , Output Rating: 18W, 5V@3.6A, Output Configuration: 1000 mm, 18/1C + Shield Cond, UL 1185, 5 Pin 180° Male DIN Plug or Equal, Ferrite: Core Size: 14.2*28.5*8.2, GlobTek Black, GT Cord # C3260, Pin Out: PIN 1,2:Common, Pin 4: N/C, Pin 3,5: +VDC, Shield: Common, Blades/Input Cord: Not Applicable, Approvals: C-Tick CB CCC CE GOST-R WEEE Ukraine IP40 Korea (12V Only) Korea (24V Only) NrCAN SIQ cUL VCCI Class I RoHS 2 China RoHS LPS Level IV PSE Korea (9V Only) Korea (15V Only) Level V PSE PSE IRAM

Model No. GT-41062-1805-T3

Part No. TR9CA3600N05NRG2336

Rev H

1. MTBF: 200,000 hours @ 25°C ambient temperature
2. Operating Temperature: 0°C to 40°C ambient temperature
3. Humidity: 0% to 90% relative humidity
4. Storage Temperature: -10°C to 80°C

E) ENCLOSURE

1. Upper Housing: High impact plastic, 94V0 polycarbonate, non-vented
2. Lower Housing: High impact plastic, 94V0 polycarbonate, non-vented
3. Size: 80.5* 50.0*31.0 mm +/-1.0

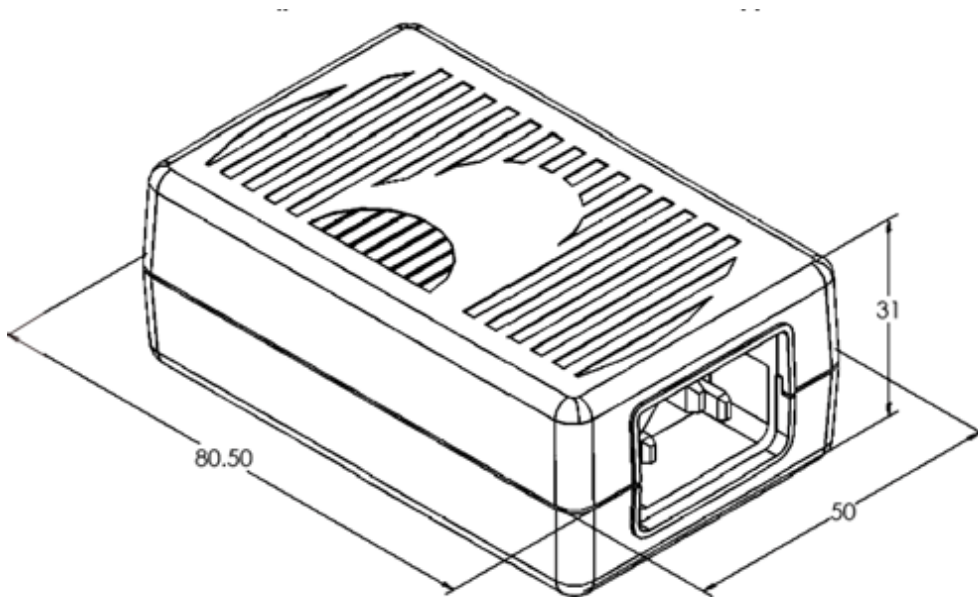

GlobTek, Inc. www.globtek.com 186 Veterans Drive, Northvale, NJ 07647 Tel. (201) 784-1000 Fax (201) 784-0111	Drawing Title: GT-41062-1805-T3, ITE Power Supply, Efficiency Level: IV, Case Color/Style: GlobTek Black, Desktop/External, Regulated Switchmode AC-DC, Input Rating: 100-240V~, 50-60 Hz, IEC 60320/C14 , Output Rating: 18W, 5V@3.6A, Output Configuration: 1000 mm, 18/1C + Shield Cond, UL 1185, 5 Pin 180° Male DIN Plug or Equal, Ferrite: Core Size: 14.2*28.5*8.2, GlobTek Black, GT Cord # C3260, Pin Out: PIN 1,2:Common, Pin 4: N/C, Pin 3,5: +VDC, Shield: Common, Blades/Input Cord: Not Applicable, Approvals: C-Tick CB CCC CE GOST-R WEEE Ukraine IP40 Korea (12V Only) Korea (24V Only) NrCAN SIQ cUL VCCI Class I RoHS 2 China RoHS LPS Level IV PSE Korea (9V Only) Korea (15V Only) Level V PSE PSE IRAM	
	Model No. GT-41062-1805-T3	
	Part No. TR9CA3600N05NRG2336	Rev H

INPUT CONFIGURATION

Blades/Cord Included: N/A: Not Applicable
 Blades/Cord Installed: N/A: Not Applicable

IEC 60320/C14 AC Inlet Connector, Class I, Earth Ground

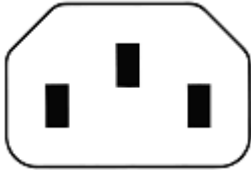

Mates with IEC 60320/C13 Plug

[Standard International IEC 320/C13 Cordsets](#)

Below are standard cordsets which are "not included" (unless stated above); these can be purchased separately or packaged with the power supply. Contact your Sales Engineer if the style required is not shown below. Many more available in different lengths, colors or cable material.

GlobTek P/N	Length	Country	Description
1191063F0701(R) to IEC 320/C13	3 FT	North American Hospital	3 CONDUCTOR: SJT 18/3, 3 Ft., BLACK, UL/CSA, HOSPITAL NEMA 5-15P
1191068F0701(R) to IEC 320/C13	8 FT	North American Hospital	3 CONDUCTOR: SJT 18/3, 8 Ft., BLACK, UL/CSA, HOSPITAL NEMA 5-15P
3021453F701(R) 320/C13	3 FT	North American	3 CONDUCTOR: SVT 18/3, 3', BLACK, UL/CSA, NEMA 5-15P to IEC
3021457F701(R) 320/C13	7 FT	North American	3 CONDUCTOR: SVT 18/3, 7', BLACK, UL/CSA, NEMA 5-15P to IEC
3021876F7701(R) to IEC 320/C13	7 FT	North American	3 CONDUCTOR: SVT, Shielded, 18/3, 6' 7", BLACK, UL/CSA, NEMA 5-15P
23144272M5701-T(R)	2.5 M	European	3 CONDUCTOR H05VVF, 3x1.00, 2.5M, CEE 7/7 to IEC 320/C13
PZ0800100-2M5BK13-H(R)	2.5 M	UK / Ireland	3 CONDUCTOR: H05VVF, 3x1.0, 2.5M, BSI, BS1363 to IEC 320/C13
5502022M5701A(R)	2.5 M	Australia	3 CONDUCTOR: GTSA 3x1.0, 2.5M, SAA, AS3112 to IEC 320/C13
3003068F2701-HK(R)	2.5 M	Japan	3 CONDUCTOR: VCTF, 3x 2.0, 2.5M, PSE, JIS8303 to IEC 320/C13
23214272M5701(R)	2.5 M	Swiss	3 CONDUCTOR: H05VVF 3x1.0, 2.5M, SEV, SEV 1011 to IEC 320/C13
23024272M5701(R) 320/C13	2.5 M	Italy	3 CONDUCTOR: H05VVF 3x 1.00, 2.5M, IMQ, CEI 23-16/VII to IEC
G8014272M5701(R) 320/C13	2.5 M	Demark	3 CONDUCTOR: H05VVF 3x 1.00, 2.5M, D, AFSNIT 107-2-D1 to IEC
2084272M5701(R)	2.5 M	India/ Africa	3 CONDUCTOR: H05VVF 3x1.0, 2.5M, BS546 to IEC 320/C13
6023602M5701(R) 320/C13	2.5 M	China	3 CONDUCTOR: RVV, 3X1.0mm ² , 2.5M, CCC, GB2099.1 (1996) to IEC
377C4272M5701(R)	2.5 M	Israel	3 CONDUCTOR: H05VVF 3x 1.00, 2.5M, ISRAEL SI-32 to IEC 320/C13
7055002M5701(R)	2.5 M	International	3 CONDUCTOR: H05VVF 3x 1.00, 2.5M, IEC320/C14 to IEC 320/C13

GlobTek, Inc.
 www.globtek.com
 186 Veterans Drive,
 Northvale, NJ 07647
 Tel. (201) 784-1000
 Fax (201) 784-0111

Drawing Title: GT-41062-1805-T3, ITE Power Supply, Efficiency Level: IV, Case Color/Style: GlobTek Black, Desktop/External, Regulated Switchmode AC-DC, Input Rating: 100-240V~, 50-60 Hz, IEC 60320/C14 , Output Rating: 18W, 5V@3.6A, Output Configuration: 1000 mm, 18/1C + Shield Cond, UL 1185, 5 Pin 180° Male DIN Plug or Equal, Ferrite: Core Size: 14.2*28.5*8.2, GlobTek Black, GT Cord # C3260, Pin Out: PIN 1,2:Common, Pin 4: N/C, Pin 3,5: +VDC, Shield: Common, Blades/Input Cord: Not Applicable, Approvals: C-Tick CB CCC CE GOST-R WEEE Ukraine IP40 Korea (12V Only) Korea (24V Only) NrCAN SIQ cUL VCCI Class I RoHS 2 China RoHS LPS Level IV PSE Korea (9V Only) Korea (15V Only) Level V PSE PSE IRAM

Model No. GT-41062-1805-T3

Part No. TR9CA3600N05NRG2336

Rev H

OUTPUT CORD AND CONNECTOR: N05/C3260

ACTUAL CONNECTORS, OVERMOLDS, FERRITES MAY VARY SLIGHTLY FROM THE PICTURE BELOW

CABLE TYPE	UL 1185
CABLE LENGTH (mm)	1000
CABLE TOLERANCE (mm)	+150-0
WIRE GAUGE (AWG)	18
CONDUCTORS	1C + Shield
HANK DIMENSION (mm)	80 ±10
CABLE / CONNECTOR OVERMOLD COLOR	GlobTek Black
FERRITE TYPE / DIMENSION	Core Size: 14.2*28.5*8.2
FERRITE # OF TURNS (Definition)	2 Pass thru core (1 turns)
FERRITE DIMENSION FROM STRAIN RELIEF	50 ± 10
FERRITE DIMENSION FROM PLUG	50 ± 10
PLUG TYPE	5 Pin 180° Male DIN Plug or Equal
OVER MOLD ORIENTATION	N/A
CONNECTOR PIN OUT:	PIN 1,2:Common, Pin 4: N/C, Pin 3,5: +VDC, Shield: Common
ADDITIONAL REQUIREMENTS	

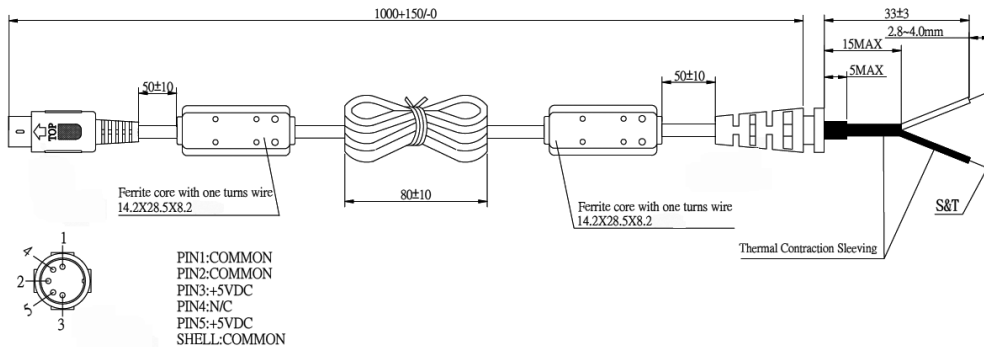

ADDITIONAL OUTPUT PLUG OPTIONS ARE AVAILABLE AT <http://www.globtek.com/connectors.php>
 STANDARD PLUGS AND CONNECTORS CAN BE SEEN ONLINE AT <http://www.globtek.com/connectors.php>

GlobTek, Inc. www.globtek.com 186 Veterans Drive, Northvale, NJ 07647 Tel. (201) 784-1000 Fax (201) 784-0111	Drawing Title: GT-41062-1805-T3, ITE Power Supply, Efficiency Level: IV, Case Color/Style: GlobTek Black, Desktop/External, Regulated Switchmode AC-DC, Input Rating: 100-240V~, 50-60 Hz, IEC 60320/C14 , Output Rating: 18W, 5V@3.6A, Output Configuration: 1000 mm, 18/1C + Shield Cond, UL 1185, 5 Pin 180° Male DIN Plug or Equal, Ferrite: Core Size: 14.2*28.5*8.2, GlobTek Black, GT Cord # C3260, Pin Out: PIN 1,2:Common, Pin 4: N/C, Pin 3,5: +VDC, Shield: Common, Blades/Input Cord: Not Applicable, Approvals: C-Tick CB CCC CE GOST-R WEEE Ukraine IP40 Korea (12V Only) Korea (24V Only) NrCAN SIQ cUL VCCI Class I RoHS 2 China RoHS LPS Level IV PSE Korea (9V Only) Korea (15V Only) Level V PSE IRAM	
	Model No. GT-41062-1805-T3	
	Part No. TR9CA3600N05NRG2336	Rev H

LABEL:L-1462

LABEL P/N: Standard GT
MATERIAL: Flat Thermal Transfer, Imprintable, Polyester Label and/or Pad Printed and/or Molded, and/or Laser Engraved in the case
BACKGROUND COLOR: Black if housing is Black, White or Silver if housing is White or Gray.
TEXT COLOR: White or Silver if label is Black Background for Black housing. Black if label is White or Silver background and Housing is White or Gray
LABEL WIDTH (mm): 39.6
LABEL HEIGHT (mm): 59.6

Below is the minimum information which will appear on the label. NOTE: in the logo area additional/actual positioning of symbols and text is subjected to change as per agency updates/requirements or additional model approvals become available.

Regulatory certifications/label markings may be in logo area on the label or molded into the case housing outside the label area. Information will be shown via label and/or pad printed and/or molded and/or laser engraved in the case. * Date code markings at GlobTek option.

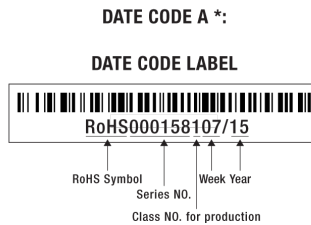

DATE CODE A *:
DATE CODE LABEL
 or
DATE CODE B *:
 WWYY
 WW = WEEK
 YY = YEAR

A=ITE Power Supply
 B=P/N: (料号) TR9CA3600N05NRG2336
 C=Model (型号) GT-41062-1805-T3
 D=Input (输入) 100-240V~, 50-60 Hz, 0.6A
 E=Output (産出) 5 V 3.6 A

AGENCY ONLINE DOCUMENTS <http://www.globtek.info/certs/GT-41062-T2-T3-T3A/>

IPXY rating is based on 3rd party testing and customers should check suitability and test system level IPXY rating before ordering.

GlobTek, Inc.
 www.globtek.com
 186 Veterans Drive,
 Northvale, NJ 07647
 Tel. (201) 784-1000
 Fax (201) 784-0111











Drawing Title: GT-41062-1805-T3, ITE Power Supply, Efficiency Level: IV, Case Color/Style: GlobTek Black, Desktop/External, Regulated Switchmode AC-DC, Input Rating: 100-240V~, 50-60 Hz, IEC 60320/C14 , Output Rating: 18W, 5V@3.6A, Output Configuration: 1000 mm, 18/1C + Shield Cond, UL 1185, 5 Pin 180° Male DIN Plug or Equal, Ferrite: Core Size: 14.2*28.5*8.2, GlobTek Black, GT Cord # C3260, Pin Out: PIN 1,2:Common, Pin 4: N/C, Pin 3,5: +VDC, Shield: Common, Blades/Input Cord: Not Applicable, Approvals: C-Tick CB CCC CE GOST-R WEEE Ukraine IP40 Korea (12V Only) Korea (24V Only) NrCAN SIQ cUL VCCI Class I RoHS 2 China RoHS LPS Level IV PSE Korea (9V Only) Korea (15V Only) Level V PSE IRAM

Model No. GT-41062-1805-T3

Part No. TR9CA3600N05NRG2336

Rev H

Regulatory Certifications/Label Markings

Logo	Description
 Pour matériel de informatique technologique. N4292 SAA111044EA	C-Tick GT-41062 N4292 SAA111044EA CB Certificate IEC 60950-1:2005 (2nd Edition), Am 1: 2009, CB report IEC 60950-1:2005 (2nd Edition), Am 1: 2009 and EN 60950-1:2006 + Am 1:2010 + Am 11:2009 + Am 12:2011
 <small>仅适用于海拔2100米以下地区使用</small>	CCC to GB4943.1-2011 GB9254-2008 GB17625.1-2012, Tropical <2000
	CE Mark: tested to comply with EN55022:2006/A1:2007 Class B, EN610003-2, EN610003-3 including EN61000-4-2, EN61000-4-3, EN61000-4-4, EN61000-4-5, EN61000-4-6N EN61000-4-11; EMI: Complies with EN55011 CLASS B and FCC Part 15B - On label or Molded in case
 	CHINA SJ/T 11364-2014, China RoHS Chart: http://en.globtek.com/globtek-rohs.php Class I Earth Ground
 LISTED 4MU8 E170507	UL60950-1, cULus to UL 60950-1, 1st Edition, 2007-10-31 and CSA C22.2 No. 60950-1-03, 1st Edition, 2006-07
	GOST-R mark for Russia(Document: http://www.globtek.com/html/iso_certificates/GT_GOST-R.pdf), 03/15/2015. Due to lack of demand, GlobTek will not be renewing it's GOST certification. Please contact your sales engineer for pricing on EAC.
 IP40	Indoor Use Only - Mark is on the label or Molded in the case Ingress Protection: IP40 to IEC60529:2001 Protection against granular foreign bodies
 DC-E-G71-001.1	IRAM certificate DC-E-G71-001.1 to IEC 60950 + A1:2009
 GlobTek, Inc.	JAPAN TUV R-PSE, Cert. No. JD 50314327, to J60950-1(H26) , J55022(H22),J3000(H25)[15V or less]. Please reference the following website for guidelines on PSE regulations: http://en.globtek.com/importing-ite-and-medical-power-supplies-ac-adaptors-to-japan/
 GlobTek, Inc.	JAPAN TUV R-PSE, Cert. No. JD 50314327, to J60950-1(H26) , J55022(H22),J3000(H25)[DC15≤30V]. Please reference the following website for guidelines on PSE regulations: http://en.globtek.com/importing-ite-and-medical-power-supplies-ac-adaptors-to-japan/

GlobTek, Inc.
 www.globtek.com
 186 Veterans Drive,
 Northvale, NJ 07647
 Tel. (201) 784-1000
 Fax (201) 784-0111

Drawing Title: GT-41062-1805-T3, ITE Power Supply, Efficiency Level: IV, Case Color/Style: GlobTek Black, Desktop/External, Regulated Switchmode AC-DC, Input Rating: 100-240V~, 50-60 Hz, IEC 60320/C14 , Output Rating: 18W, 5V@3.6A, Output Configuration: 1000 mm, 18/1C + Shield Cond, UL 1185, 5 Pin 180° Male DIN Plug or Equal, Ferrite: Core Size: 14.2*28.5*8.2, GlobTek Black, GT Cord # C3260, Pin Out: PIN 1,2:Common, Pin 4: N/C, Pin 3,5: +VDC, Shield: Common, Blades/Input Cord: Not Applicable, Approvals: C-Tick CB CCC CE GOST-R WEEE Ukraine IP40 Korea (12V Only) Korea (24V Only) NrCAN SIQ cUL VCCI Class I RoHS 2 China RoHS LPS Level IV PSE Korea (9V Only) Korea (15V Only) Level V PSE IRAM

Model No. GT-41062-1805-T3

Part No. TR9CA3600N05NRG2336

Rev H

 직류전원장치 AC/DC ADAPTER
 KTC HU10499-9002A
 모델명:GT-41062-1809-T3
 Mfr. Name: GLOBTEK (SUZHOU) CO.,LTD
 A/S Center: 10-6221-6100

Korea KET KC Mark GT-41062-1809-T3 HU10499-9002A (9V Only)

 직류전원장치 AC/DC ADAPTER
 KTC HU10499-9002A
 모델명:GT-41062-1812-T3
 Mfr. Name: GLOBTEK (SUZHOU) CO.,LTD
 A/S Center: 10-6221-6100

Korea KET KC Mark GT-41062-1812-T3 HU10499-9002A (12V Only)

 직류전원장치 AC/DC ADAPTER
 KTC HU10499-9002A
 모델명:GT-41062-1815-T3
 Mfr. Name: GLOBTEK (SUZHOU) CO.,LTD
 A/S Center: 10-6221-6100

Korea KET KC Mark GT-41062-1815-T3 HU10499-9002A (15V Only)

 직류전원장치 AC/DC ADAPTER
 KTC HU10499-9001A
 모델명:GT-41062-1824-T3
 Mfr. Name: GLOBTEK (SUZHOU) CO.,LTD
 A/S Center: 10-6221-6100

Korea KET KC Mark GT-41062-1824-T3 HU10499-9001A (24V Only)

EFFICIENCY LEVEL 

Efficiency: complies to section 301 of Energy Independence and Security Act (EISA) complies with Energy Star tier 2 (North America), ECP tier 2 (China), MEPS tier 2 (Australia), Code of Conduct (Europe)

EFFICIENCY LEVEL 

Efficiency: complies to section 301 of Energy Independence and Security Act (EISA) complies with Energy Star tier 2 (North America), ECP tier 2 (China), MEPS tier 2 (Australia), Code of Conduct (Europe)... NOTE: 24V & 1830 mm 18 - 20awg o/p cord only

LPS

Limited Power Source



Natural Resources Canada (NRCAN): CSA Standard C381.1-08, QSP NRCAN EEV1191;

<http://shop.csa.ca/en/canada/energy-efficiency/canca-c3811-08/inv/27024802008>



GlobTek, Inc.

JAPAN TUV Rheinland-PSE GlobTek Inc to J60950-1(H26) , J55022(H22),J3000(H25).Please follow the procedure listed in the following link for proper import to Japan: <http://en.globtek.com/importing-to-japan.php>.

RoHS 2

RoHS 2: Complies with EU 2011/65/EU and CHINA SJ/T 11363-2006

<http://www.ce-mark.com/Rohs%20final.pdf>



IEC/EN60950-1

SIQ Mark License Certificate EN 60950-1:2006 + Am 1:2010+ Am 11:2009 + Am 12:2011



Ukraine UKRSepro (Document: www.globtek.com/html/iso_certificates/GT_Ukraine.pdf)



Japan: Voluntary Control Council for Interference (VCCI)

WEEE: Complies with EU 2012/19/EU (

http://ec.europa.eu/environment/waste/weee/index_en.htm)

Mark is on the label or Molded in the case

GlobTek, Inc.
www.globtek.com
186 Veterans Drive,
Northvale, NJ 07647
Tel. (201) 784-1000
Fax (201) 784-0111

Drawing Title: GT-41062-1805-T3, ITE Power Supply, Efficiency Level: IV, Case Color/Style: GlobTek Black, Desktop/External, Regulated Switchmode AC-DC, Input Rating: 100-240V~, 50-60 Hz, IEC 60320/C14 , Output Rating: 18W, 5V@3.6A, Output Configuration: 1000 mm, 18/1C + Shield Cond, UL 1185, 5 Pin 180° Male DIN Plug or Equal, Ferrite: Core Size: 14.2*28.5*8.2, GlobTek Black, GT Cord # C3260, Pin Out: PIN 1,2:Common, Pin 4: N/C, Pin 3,5: +VDC, Shield: Common, Blades/Input Cord: Not Applicable, Approvals: C-Tick CB CCC CE GOST-R WEEE Ukraine IP40 Korea (12V Only) Korea (24V Only) NrCAN SIQ cUL VCCI Class I RoHS 2 China RoHS LPS Level IV PSE Korea (9V Only) Korea (15V Only) Level V PSE PSE IRAM

Model No. GT-41062-1805-T3

Part No. TR9CA3600N05NRG2336

Rev H

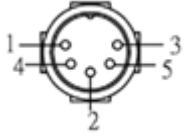

PIN 1,2:Common, Pin 4: N/C, Pin 3,5: +VDC, Shield: Common

GlobTek, Inc.
 www.globtek.com
 186 Veterans Drive,
 Northvale, NJ 07647
 Tel. (201) 784-1000
 Fax (201) 784-0111

Drawing Title: GT-41062-1805-T3, ITE Power Supply, Efficiency Level: IV, Case Color/Style: GlobTek Black, Desktop/External, Regulated Switchmode AC-DC, Input Rating: 100-240V~, 50-60 Hz, IEC 60320/C14 , Output Rating: 18W, 5V@3.6A, Output Configuration: 1000 mm, 18/1C + Shield Cond, UL 1185, 5 Pin 180° Male DIN Plug or Equal, Ferrite: Core Size: 14.2*28.5*8.2, GlobTek Black, GT Cord # C3260, Pin Out: PIN 1,2:Common, Pin 4: N/C, Pin 3,5: +VDC, Shield: Common, Blades/Input Cord: Not Applicable, Approvals: C-Tick CB CCC CE GOST-R WEEE Ukraine IP40 Korea (12V Only) Korea (24V Only) NrCAN SIQ cUL VCCI Class I RoHS 2 China RoHS LPS Level IV PSE Korea (9V Only) Korea (15V Only) Level V PSE PSE IRAM

Model No. GT-41062-1805-T3

Part No. TR9CA3600N05NRG2336

Rev H

PACKAGING

Packing Spec P/N: TR9CA3600N05NRG2336
 Box Qty: 80
 Gift Box Size (mm): 110*70*57
 Gift Box Color: White
 Master Carton Size (mm): 463*318*305
 Master GW (Kg): 15.2 kg
 BLADES INCLUDED: N/A: Not Applicable
 BLADE/CORD INSTALLED: N/A: Not Applicable

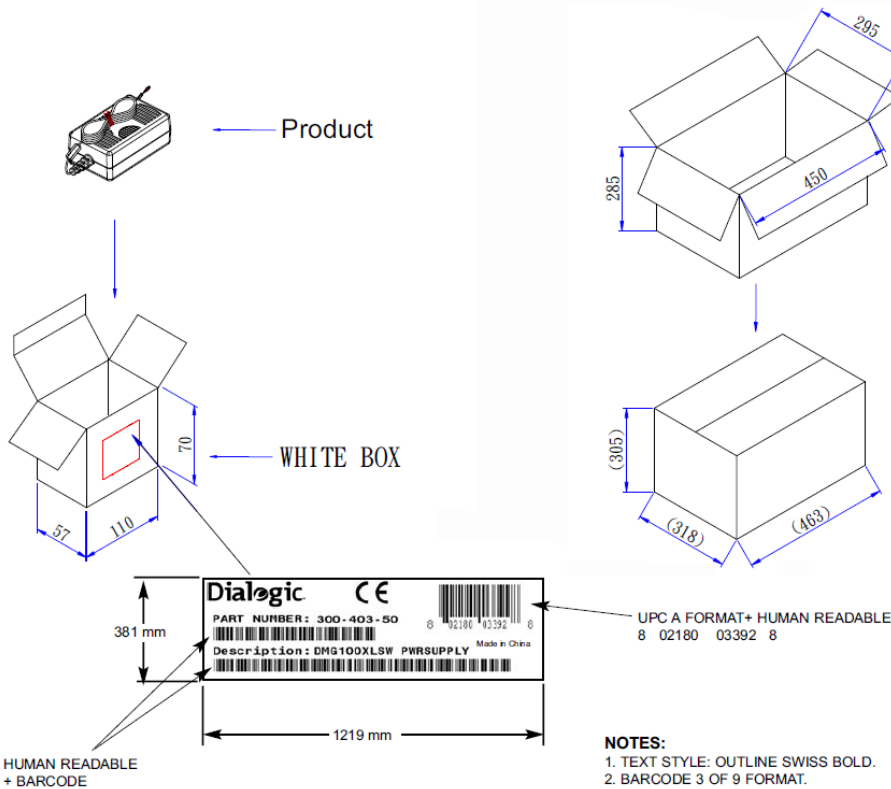

GloTek, Inc. www.globtek.com 186 Veterans Drive, Northvale, NJ 07647 Tel. (201) 784-1000 Fax (201) 784-0111	Drawing Title: GT-41062-1805-T3, ITE Power Supply, Efficiency Level: IV, Case Color/Style: GlobTek Black, Desktop/External, Regulated Switchmode AC-DC, Input Rating: 100-240V~, 50-60 Hz, IEC 60320/C14 , Output Rating: 18W, 5V@3.6A, Output Configuration: 1000 mm, 18/1C + Shield Cond, UL 1185, 5 Pin 180° Male DIN Plug or Equal, Ferrite: Core Size: 14.2*28.5*8.2, GlobTek Black, GT Cord # C3260, Pin Out: PIN 1,2:Common, Pin 4: N/C, Pin 3,5: +VDC, Shield: Common, Blades/Input Cord: Not Applicable, Approvals: C-Tick CB CCC CE GOST-R WEEE Ukraine IP40 Korea (12V Only) Korea (24V Only) NrCAN SIQ cUL VCCI Class I RoHS 2 China RoHS LPS Level IV PSE Korea (9V Only) Korea (15V Only) Level V PSE PSE IRAM	
	Model No. GT-41062-1805-T3	
	Part No. TR9CA3600N05NRG2336	Rev H

INSTRUCTION SHEET

N/A