

GBPC25005 THRU GBPC2510 SINGLE PHASE 25 AMP GLASS PASSIVATED BRIDGE RECTIFIER



Features

- Glass passivated die construction
- Low forward voltage drop
- High current capability
- High surge current capability
- Plastic material-UL flammability 94V-0
- This is a Pb – Free device
- All SMC parts are traceable to the wafer lot
- Additional testing can be offered upon request

Circuit Diagram

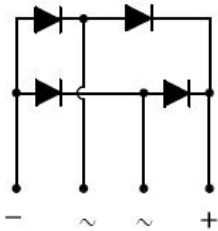

Mechanical Data

- Case: GBPC, molded plastic
- Terminals: plated leads solderable per MIL-STD-202, Method 208
- Polarity: as marked on case
- Mounting position: Any
- Lead Free: For RoHS / Lead Free Version

Maximum Ratings: @T_A=25°C unless otherwise specified

Single Phase, half wave, 60Hz, resistive or inductive load. For capacitive load, derate current by 20%.

Type number	Symbol	GBPC 25005	GBPC 2501	GBPC 2502	GBPC 2504	GBPC 2506	GBPC 2508	GBPC 2510	Units
Peak Repetitive Reverse Voltage Working Peak Reverse Voltage DC Blocking Voltage	V _{RRM}	50	100	200	400	600	800	1000	V
RMS Reverse Voltage	V _{RMS}	35	70	140	280	420	560	700	V
Average Rectified Output Current (Note 1) @ T _A =55°C	I _o	25							A
Peak forward surge current 8.3ms single half sine-wave superimposed on rated load (JEDEC Method)	I _{FSM}	300							A

Electrical Characteristics: @ $T_A=25^\circ\text{C}$ unless otherwise specified

Type number	Symbol	GBPC 25005	GBPC 2501	GBPC 2502	GBPC 2504	GBPC 2506	GBPC 2508	GBPC 2510	Units
Forward Voltage per element @ $I_F=12.5\text{A}$	V_F					1.1			V
Peak Reverse Current @ $T_A=25^\circ\text{C}$ At Rated DC Blocking Voltage @ $T_A=125^\circ\text{C}$	I_R					5 500			μA
Typical Junction Capacitance (Note 2)	C_J					300			pF

* Pulse width < 300 μs , duty cycle < 2%

Thermal-Mechanical Specifications: @ $T_A=25^\circ\text{C}$ unless otherwise specified

Type number	Symbol	GBPC 25005	GBPC 2501	GBPC 2502	GBPC 2504	GBPC 2506	GBPC 2508	GBPC 2510	Units
Typical Thermal Resistance Junction to Lead	$R_{\theta JL}$					2.2			
Junction Temperature	T_J					-55 to +150			$^\circ\text{C}$
Storage Temperature Range	T_{STG}					-55 to +150			$^\circ\text{C}$

Note: 1. Mounted on glass epoxy PC board with 1.3mm² solder pad.
2. Measured at 1.0 MHz and applied reverse voltage of 4.0V D.C.

Ratings and Characteristics Curves

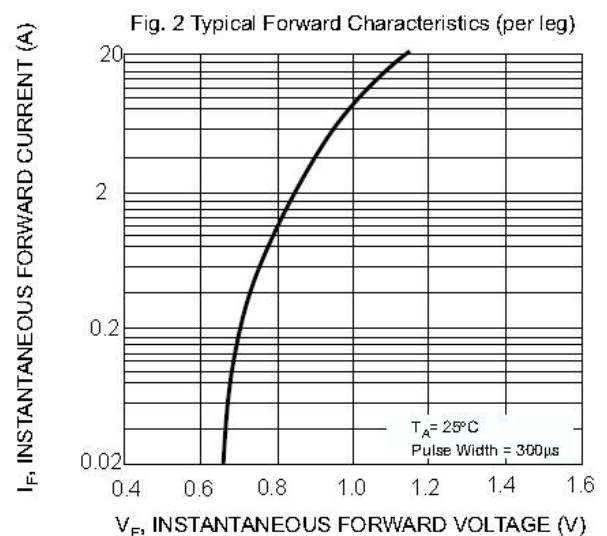
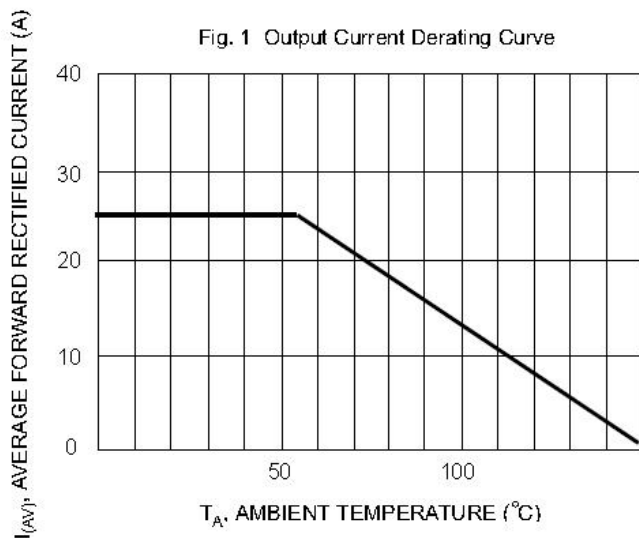

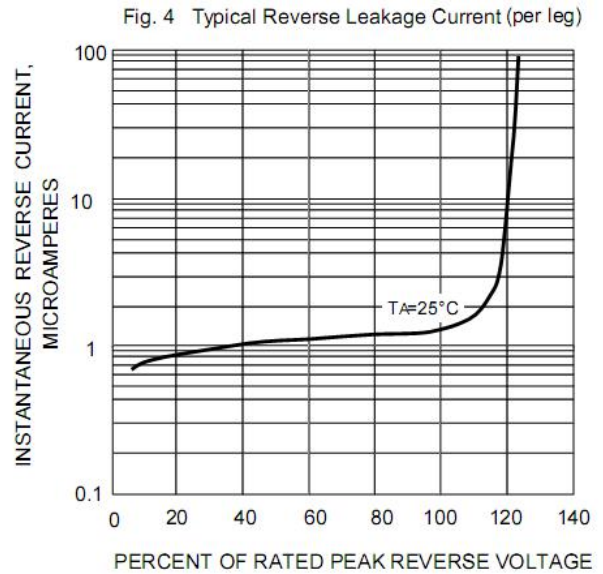
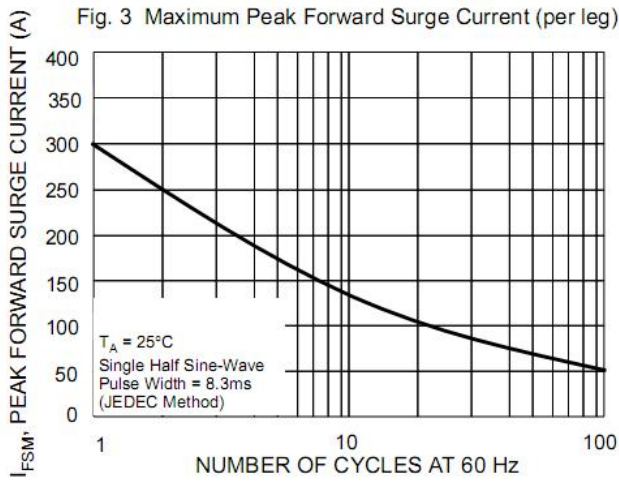

Ordering Information

Device	Package	Plating	Shipping
GBPC25005-GBPC2510	GBPC(Pb-Free)	Pure Sn	50pcs / box

For information on tape and reel specifications, including part orientation and tape sizes, please refer to our tape and reel packaging specification.

Marking Diagram

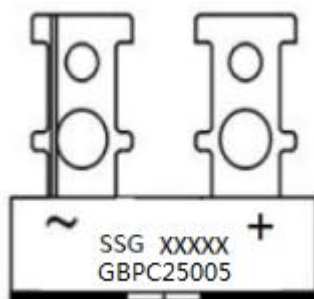

Where XXXXX is YYWWL

SSG = SSG
 YY = Year
 WW = Week
 L = Lot Number
 GBPC25005 = Type Number

Cautions: Molding resin
 Epoxy resin UL:94V-0

Mechanical Dimensions GBPC (Inches/Millimeters)

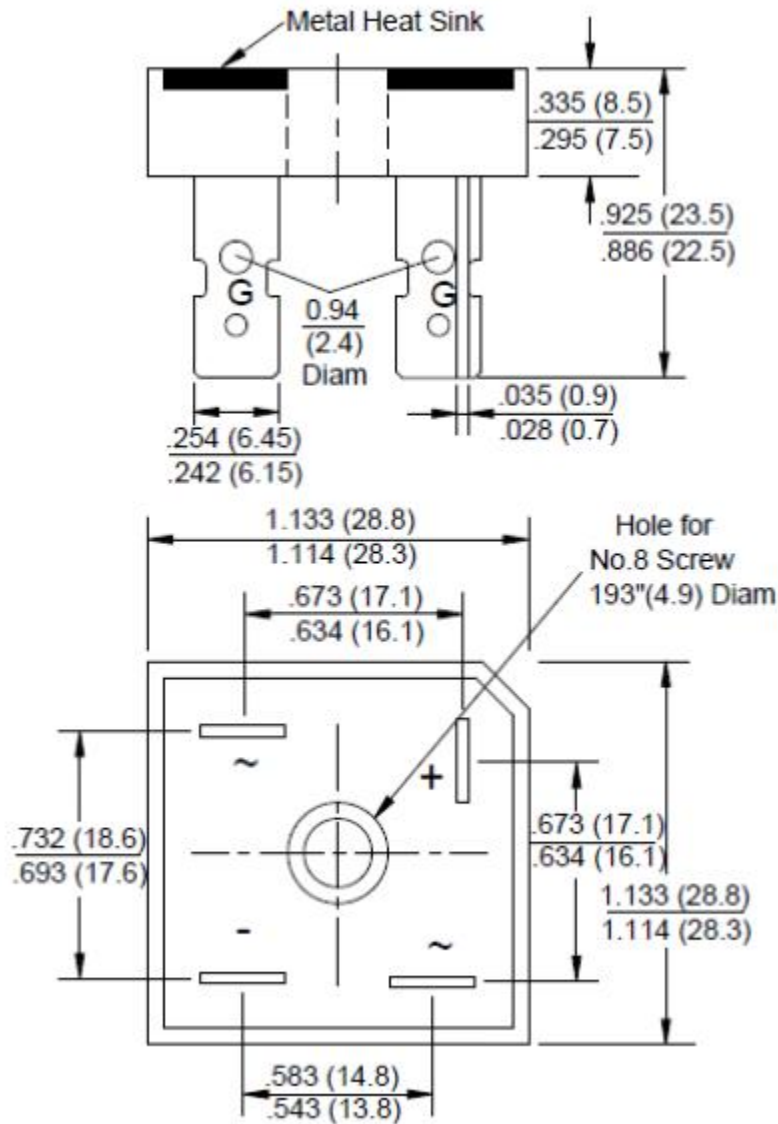

DISCLAIMER:

- 1- The information given herein, including the specifications and dimensions, is subject to change without prior notice to improve product characteristics. Before ordering, purchasers are advised to contact the SMC Diode Solutions sales department for the latest version of the datasheet(s).
- 2- In cases where extremely high reliability is required (such as use in nuclear power control, aerospace and aviation, traffic equipment, medical equipment, and safety equipment), safety should be ensured by using semiconductor devices that feature assured safety or by means of users' fail-safe precautions or other arrangement.
- 3- In no event shall SMC Diode Solutions be liable for any damages that may result from an accident or any other cause during operation of the user's units according to the datasheet(s). SMC Diode Solution assumes no responsibility for any intellectual property claims or any other problems that may result from applications of information, products or circuits described in the datasheets.
- 4- In no event shall SMC Diode Solutions be liable for any failure in a semiconductor device or any secondary damage resulting from use at a value exceeding the absolute maximum rating.
- 5- No license is granted by the datasheet(s) under any patents or other rights of any third party or SMC Diode Solutions.
- 6- The datasheet(s) may not be reproduced or duplicated, in any form, in whole or part, without the expressed written permission of SMC Diode Solutions.
- 7- The products (technologies) described in the datasheet(s) are not to be provided to any party whose purpose in their application will hinder maintenance of international peace and safety nor are they to be applied to that purpose by their direct purchasers or any third party. When exporting these products (technologies), the necessary procedures are to be taken in accordance with related laws and regulations.