

PNP RF Transistor

MMBTH81

This device is designed for general RF amplifier and mixer applications to 250 MHz with collector currents in the 1.0 mA to 30 mA range. Sourced from Process 75.

Features

- These Devices are Pb-Free, Halogen Free/BFR Free and are RoHS Compliant
- NSV Prefix for Automotive and Other Applications Requiring Unique Site and Control Change Requirements; AEC-Q101 Qualified and PPAP Capable

MAXIMUM RATINGS (T_A = 25°C unless otherwise noted)

Rating	Symbol	Value	Units
Collector - Emitter Voltage	V _{CEO}	20	V
Collector - Base Voltage	V _{CBO}	20	V
Emitter - Base Voltage	V _{EBO}	3.0	V
Collector Current - Continuous	I _C	50	mA
Operating and Storage Junction Temperature Range	T _J , T _{stg}	-55 to +150	°C

THERMAL CHARACTERISTICS (T_A = 25°C unless otherwise noted)

Characteristic	Symbol	Max	Unit
Total Device Dissipation Derate above 25°C	P _D	225 1.8	mW mW/°C
Thermal Resistance, Junction to Ambient	R _{θJA}	556	°C/W

Stresses exceeding those listed in the Maximum Ratings table may damage the device. If any of these limits are exceeded, device functionality should not be assumed, damage may occur and reliability may be affected.

1. Device mounted on FR-4 PCB 1.6 × 1.6 × 0.06 in.
2. These ratings are based on a maximum junction temperature of 150°C.
3. These are steady state limits. The factory should be consulted on applications involving pulsed or low duty cycle operations.
4. All voltages (V) and currents (A) are negative polarity for PNP transistors.

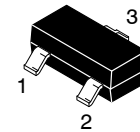
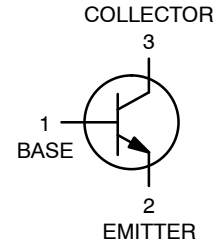

SOT-23
CASE 318-08
STYLE 6

MARKING DIAGRAM

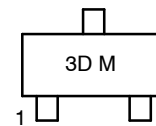

3D = Specific Device Code
M = Date Code*

*Date Code orientation and/or overbar may vary depending upon manufacturing location.

ORDERING INFORMATION

See detailed ordering and shipping information in the package dimensions section on page 2 of this data sheet.

MMBTH81

ELECTRICAL CHARACTERISTICS ($T_A = 25^\circ\text{C}$ unless otherwise noted)

Symbol	Parameter	Test Conditions	Min	Max	Units
OFF CHARACTERISTICS					
$V_{(BR)CEO}$	Collector – Emitter Breakdown Voltage (Note 5)	$I_C = 1.0\text{ mA}, I_B = 0$	20		V
$V_{(BR)CBO}$	Collector – Base Breakdown Voltage	$I_C = 10\ \mu\text{A}, I_E = 0$	20		V
$V_{(BR)EBO}$	Emitter – Base Breakdown Voltage	$I_E = 10\ \mu\text{A}, I_C = 0$	3.0		V
I_{CBO}	Collector Cutoff Current	$V_{CB} = 10\text{ V}, I_E = 0$		100	nA
I_{EBO}	Emitter Cutoff Current	$V_{EB} = 2.0\text{ V}, I_C = 0$		100	nA

ON CHARACTERISTICS

h_{FE}	DC Current Gain	$I_C = 5.0\text{ mA}, V_{CE} = 10\text{ V}$	60		
$V_{CE(sat)}$	Collector – Emitter Saturation Voltage	$I_C = 5.0\text{ mA}, I_B = 0.5\text{ mA}$		0.5	V
$V_{BE(sat)}$	Base – Emitter Saturation Voltage	$I_C = 5.0\text{ mA}, V_{CE} = 10\text{ V}$		0.9	V

SMALL SIGNAL CHARACTERISTICS

f_T	Current Gain – Bandwidth Product	$I_C = 5.0\text{ mA}, V_{CE} = 10\text{ V}, f = 100\text{ MHz}$	600		MHz
C_{cb}	Collector–Base Capacitance	$V_{CB} = 10\text{ V}, I_E = 0, f = 1.0\text{ MHz}$		0.85	pF
C_{ce}	Collector Emitter Capacitance	$V_{CB} = 10\text{ V}, I_B = 0, f = 1.0\text{ MHz}$		0.65	pF

Product parametric performance is indicated in the Electrical Characteristics for the listed test conditions, unless otherwise noted. Product performance may not be indicated by the Electrical Characteristics if operated under different conditions.

5. Pulse Test: Pulse Width $\leq 300\ \mu\text{s}$, Duty Cycle $\leq 2.0\%$.

SPICE MODEL

PNP(Is=10f Xti=3 Eg=1.11 Vaf=100 Bf=133.8 Ise=1.678p Ne=2.159 Ikf=.1658 Nk=.901 Xtb=1.5 Var=100 Br=1 Isc=9.519n Nc=3.88 Ikr=5.813 Rc=7.838 Cjc=2.81p Mjc=.1615 Vjc=.8282 Fc=.5 Cje=2.695p Mje=.3214 Vje=.7026 Tr=11.32n Tf=97.83p Itf=69.29 Xtf=599u Vtf=10)

ORDERING INFORMATION

Device	Specific Marking Code	Package	Shipping†
NSVMMBTH81LT1G*	3D	SOT-23 (Pb-Free)	3,000 / Tape & Reel
NSVMMBTH81LT3G*	3D	SOT-23 (Pb-Free)	10,000 / Tape & Reel

†For information on tape and reel specifications, including part orientation and tape sizes, please refer to our Tape and Reel Packaging Specifications Brochure, BRD8011/D.

*NSV Prefix for Automotive and Other Applications Requiring Unique Site and Control Change Requirements; AEC-Q101 Qualified and PPAP Capable.

MMBT81

TYPICAL CHARACTERISTICS

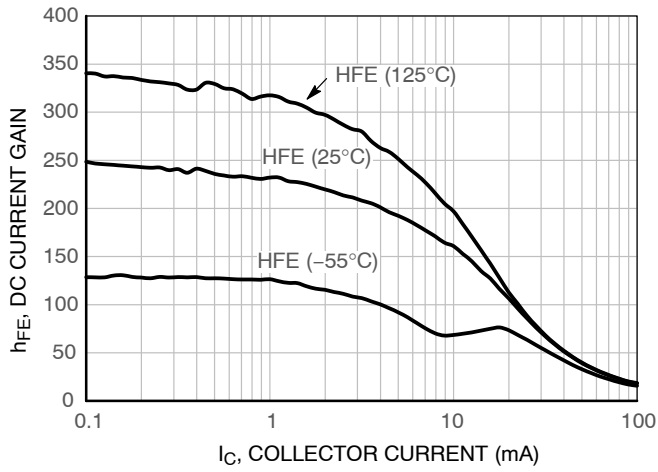

Figure 1. DC Current Gain vs. Collector Current

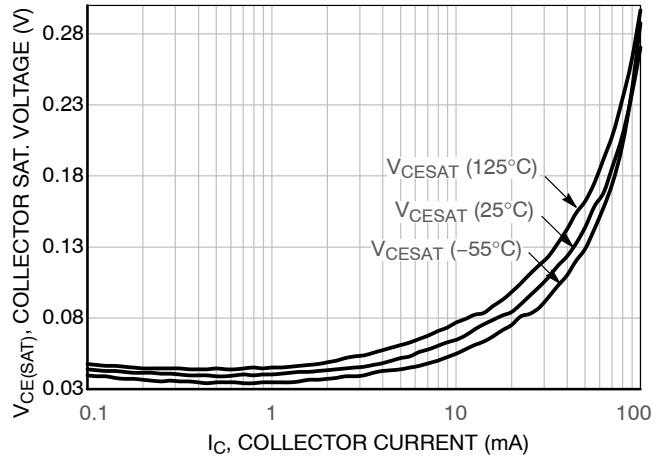

Figure 2. Collector Saturation Voltage vs. Collector Current

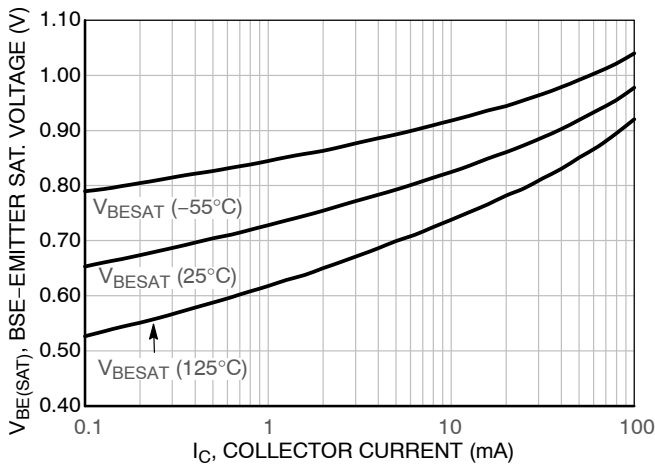

Figure 3. Base-Emitter Saturation Voltage vs. Collector Current

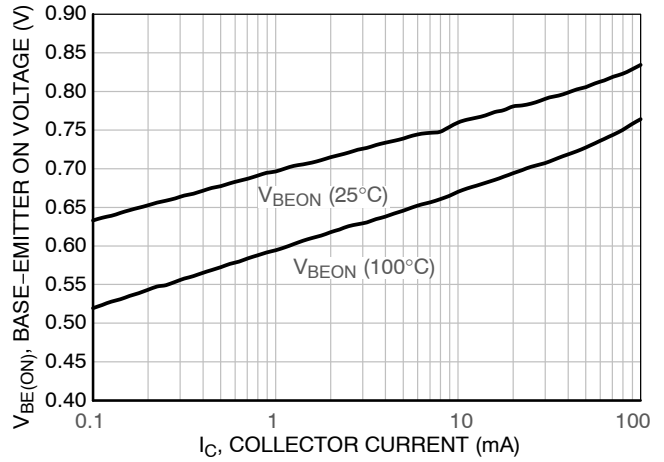

Figure 4. Base-Emitter ON Voltage vs. Collector Current

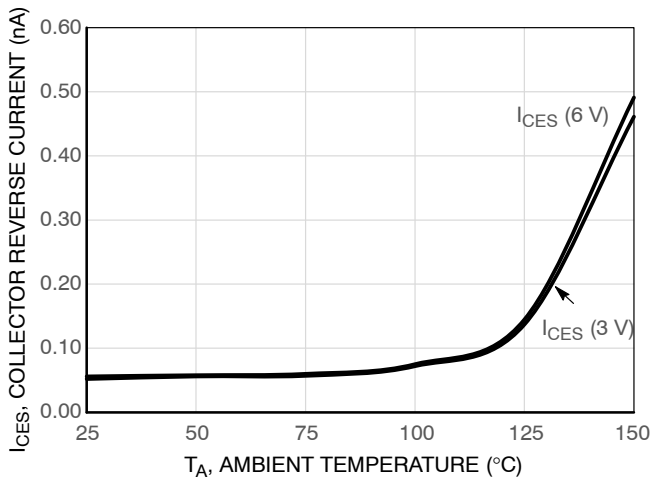

Figure 5. Collector Reverse Current vs. Ambient Temperature

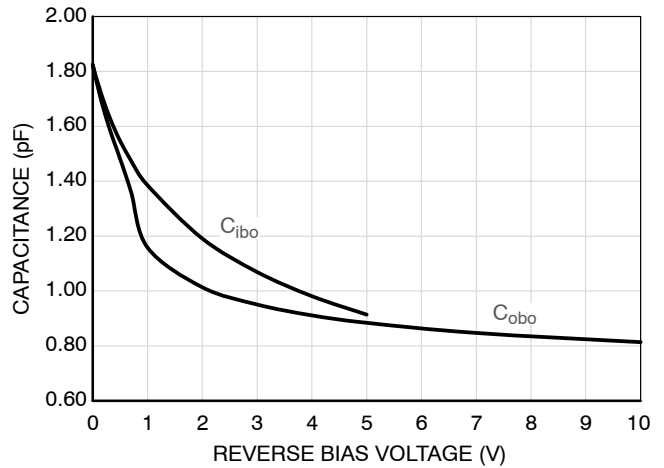

Figure 6. Input /Output Capacitance vs. Reverse Bias Voltage

MECHANICAL CASE OUTLINE

PACKAGE DIMENSIONS

ON Semiconductor®



SOT-23 (TO-236)
CASE 318-08
ISSUE AS

DATE 30 JAN 2018

SCALE 4:1

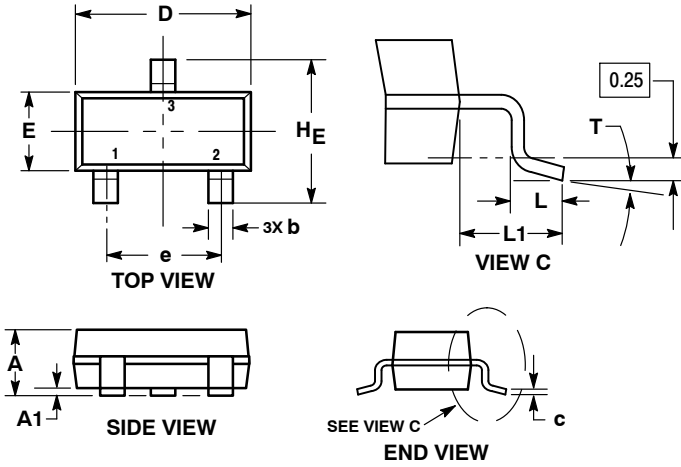

NOTES:

1. DIMENSIONING AND TOLERANCING PER ASME Y14.5M, 1994.
2. CONTROLLING DIMENSION: MILLIMETERS.
3. MAXIMUM LEAD THICKNESS INCLUDES LEAD FINISH. MINIMUM LEAD THICKNESS IS THE MINIMUM THICKNESS OF THE BASE MATERIAL.
4. DIMENSIONS D AND E DO NOT INCLUDE MOLD FLASH, PROTRUSIONS, OR GATE BURRS.

DIM	MILLIMETERS			INCHES		
	MIN	NOM	MAX	MIN	NOM	MAX
A	0.89	1.00	1.11	0.035	0.039	0.044
A1	0.01	0.06	0.10	0.000	0.002	0.004
b	0.37	0.44	0.50	0.015	0.017	0.020
c	0.08	0.14	0.20	0.003	0.006	0.008
D	2.80	2.90	3.04	0.110	0.114	0.120
E	1.20	1.30	1.40	0.047	0.051	0.055
e	1.78	1.90	2.04	0.070	0.075	0.080
L	0.30	0.43	0.55	0.012	0.017	0.022
L1	0.35	0.54	0.69	0.014	0.021	0.027
HE	2.10	2.40	2.64	0.083	0.094	0.104
T	0°	---	10°	0°	---	10°

RECOMMENDED SOLDERING FOOTPRINT

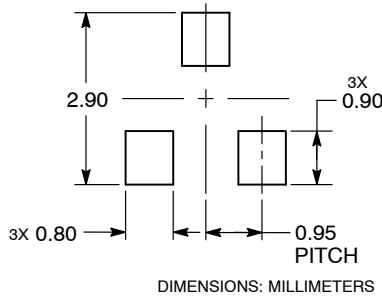

GENERIC MARKING DIAGRAM*



XXX = Specific Device Code
M = Date Code
▪ = Pb-Free Package

*This information is generic. Please refer to device data sheet for actual part marking. Pb-Free indicator, "G" or microdot "▪", may or may not be present.

STYLE 1 THRU 5:
CANCELLED

STYLE 6:
PIN 1. BASE
2. EMITTER
3. COLLECTOR

STYLE 7:
PIN 1. EMITTER
2. BASE
3. COLLECTOR

STYLE 8:
PIN 1. ANODE
2. NO CONNECTION
3. CATHODE

STYLE 9:
PIN 1. ANODE
2. ANODE
3. CATHODE

STYLE 10:
PIN 1. DRAIN
2. SOURCE
3. GATE

STYLE 11:
PIN 1. ANODE
2. CATHODE
3. CATHODE-ANODE

STYLE 12:
PIN 1. CATHODE
2. CATHODE
3. ANODE

STYLE 13:
PIN 1. SOURCE
2. DRAIN
3. GATE

STYLE 14:
PIN 1. CATHODE
2. GATE
3. ANODE

STYLE 15:
PIN 1. GATE
2. CATHODE
3. ANODE

STYLE 16:
PIN 1. ANODE
2. CATHODE
3. CATHODE

STYLE 17:
PIN 1. NO CONNECTION
2. ANODE
3. CATHODE

STYLE 18:
PIN 1. NO CONNECTION
2. CATHODE
3. ANODE

STYLE 19:
PIN 1. CATHODE
2. ANODE
3. CATHODE-ANODE

STYLE 20:
PIN 1. CATHODE
2. ANODE
3. GATE

STYLE 21:
PIN 1. GATE
2. SOURCE
3. DRAIN

STYLE 22:
PIN 1. RETURN
2. OUTPUT
3. INPUT

STYLE 23:
PIN 1. ANODE
2. ANODE
3. CATHODE

STYLE 24:
PIN 1. GATE
2. DRAIN
3. SOURCE

STYLE 25:
PIN 1. ANODE
2. CATHODE
3. GATE

STYLE 26:
PIN 1. CATHODE
2. ANODE
3. NO CONNECTION

STYLE 27:
PIN 1. CATHODE
2. CATHODE
3. CATHODE

STYLE 28:
PIN 1. ANODE
2. ANODE
3. ANODE

DOCUMENT NUMBER:	98ASB42226B	Electronic versions are uncontrolled except when accessed directly from the Document Repository. Printed versions are uncontrolled except when stamped "CONTROLLED COPY" in red.
DESCRIPTION:	SOT-23 (TO-236)	PAGE 1 OF 1

ON Semiconductor and are trademarks of Semiconductor Components Industries, LLC dba ON Semiconductor or its subsidiaries in the United States and/or other countries. ON Semiconductor reserves the right to make changes without further notice to any products herein. ON Semiconductor makes no warranty, representation or guarantee regarding the suitability of its products for any particular purpose, nor does ON Semiconductor assume any liability arising out of the application or use of any product or circuit, and specifically disclaims any and all liability, including without limitation special, consequential or incidental damages. ON Semiconductor does not convey any license under its patent rights nor the rights of others.

onsemi, **Onsemi**, and other names, marks, and brands are registered and/or common law trademarks of Semiconductor Components Industries, LLC dba "**onsemi**" or its affiliates and/or subsidiaries in the United States and/or other countries. **onsemi** owns the rights to a number of patents, trademarks, copyrights, trade secrets, and other intellectual property. A listing of **onsemi**'s product/patent coverage may be accessed at www.onsemi.com/site/pdf/Patent-Marking.pdf. **onsemi** reserves the right to make changes at any time to any products or information herein, without notice. The information herein is provided "as-is" and **onsemi** makes no warranty, representation or guarantee regarding the accuracy of the information, product features, availability, functionality, or suitability of its products for any particular purpose, nor does **onsemi** assume any liability arising out of the application or use of any product or circuit, and specifically disclaims any and all liability, including without limitation special, consequential or incidental damages. Buyer is responsible for its products and applications using **onsemi** products, including compliance with all laws, regulations and safety requirements or standards, regardless of any support or applications information provided by **onsemi**. "Typical" parameters which may be provided in **onsemi** data sheets and/or specifications can and do vary in different applications and actual performance may vary over time. All operating parameters, including "Typicals" must be validated for each customer application by customer's technical experts. **onsemi** does not convey any license under any of its intellectual property rights nor the rights of others. **onsemi** products are not designed, intended, or authorized for use as a critical component in life support systems or any FDA Class 3 medical devices or medical devices with a same or similar classification in a foreign jurisdiction or any devices intended for implantation in the human body. Should Buyer purchase or use **onsemi** products for any such unintended or unauthorized application, Buyer shall indemnify and hold **onsemi** and its officers, employees, subsidiaries, affiliates, and distributors harmless against all claims, costs, damages, and expenses, and reasonable attorney fees arising out of, directly or indirectly, any claim of personal injury or death associated with such unintended or unauthorized use, even if such claim alleges that **onsemi** was negligent regarding the design or manufacture of the part. **onsemi** is an Equal Opportunity/Affirmative Action Employer. This literature is subject to all applicable copyright laws and is not for resale in any manner.

PUBLICATION ORDERING INFORMATION

LITERATURE FULFILLMENT:

Email Requests to: orderlit@onsemi.com

onsemi Website: www.onsemi.com

TECHNICAL SUPPORT

North American Technical Support:

Voice Mail: 1 800-282-9855 Toll Free USA/Canada

Phone: 011 421 33 790 2910

Europe, Middle East and Africa Technical Support:

Phone: 00421 33 790 2910

For additional information, please contact your local Sales Representative