

MMPQ2222

MMPQ2222

NPN Multi-Chip General Purpose Amplifier

- This device is for use as a medium power amplifier and switch requiring collector currents up to 500mA.
- Sourced from process 19.

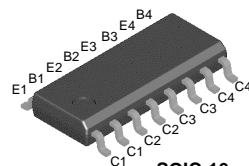

SOIC-16
Mark: MMPQ2222

Absolute Maximum Ratings * $T_a=25^\circ\text{C}$ unless otherwise noted

Symbol	Parameter	Value	Units
V_{CEO}	Collector-Emitter Voltage	30	V
V_{CBO}	Collector-Base Voltage	60	V
V_{EBO}	Emitter-Base Voltage	5.0	V
I_C	Collector Current - Continuous	500	mA
T_J, T_{STG}	Operating and Storage Junction Temperature Range	- 55 ~ +155	$^\circ\text{C}$

* These ratings are limiting values above which the serviceability of any semiconductor device may be impaired

NOTES:

- 1) These ratings are based on a maximum junction temperature of 150 degrees C.
- 2) These are steady state limits. The factory should be consulted on applications involving pulsed or low duty cycle operations

Electrical Characteristics $T_a=25^\circ\text{C}$ unless otherwise noted

Symbol	Parameter	Test Condition	Min.	Max.	Units
Off Characteristics					
$V_{(BR)CEO}$	Collector-Emitter Breakdown Voltage *	$I_C = 10\text{mA}, I_B = 0$	30		V
$V_{(BR)CBO}$	Collector-Base Breakdown Voltage	$I_C = 10\mu\text{A}, I_E = 0$	60		V
$V_{(BR)EBO}$	Emitter-Base Breakdown Voltage	$I_C = 10\mu\text{A}, I_C = 0$	5.0		V
I_{CBO}	Collector Cutoff Current	$V_{CB} = 50\text{V}, I_E = 0$		50	nA
I_{EBO}	Emitter Cutoff Current	$V_{EB} = 3.0\text{V}, I_C = 0$		50	nA
On Characteristics *					
h_{FE}	DC Current Gain	$I_C = 10\text{mA}, V_{CE} = 10\text{V}$ $I_C = 150\text{mA}, V_{CE} = 1.0\text{V}^*$ $I_C = 150\text{mA}, V_{CE} = 1.0\text{V}^*$	75 100 50		
$V_{CE(sat)}$	Collector-Emitter Saturation Voltage *	$I_C = 150\text{mA}, I_B = 15\text{mA}$ $I_C = 500\text{mA}, I_B = 50\text{mA}$		0.4 1.6	V V
$V_{BE(sat)}$	Base-Emitter Saturation Voltage *	$I_C = 150\text{mA}, I_B = 15\text{mA}$ $I_C = 500\text{mA}, I_B = 50\text{mA}$		1.3 2.6	V V
Small Signal Characteristics					
f_T	Current Gain Bandwidth Product	$I_C = 20\text{mA}, V_{CE} = 20\text{V},$ $f = 100\text{MHz}$		300	MHz
C_{obo}	Output Capacitance	$V_{CB} = 10\text{V}, I_E = 0, f = 100\text{kHz}$		4.0	pF
C_{ibo}	Input Capacitance	$V_{EB} = 0.5\text{V}, I_E = 0, f = 100\text{kHz}$		20	pF
NF	Noise Figure	$I_C = 100\mu\text{A}, V_{CE} = 10\text{V},$ $R_S = 1.0\text{k}\Omega, f = 1.0\text{kHz}$		2.0	dB

* Pulse Test: Pulse Width $\leq 300\mu\text{s}$, Duty Cycle $\leq 2.0\%$

Thermal Characteristics $T_a=25^\circ\text{C}$ unless otherwise noted

Symbol	Parameter	Max.	Units
P_D	Total Device Dissipation	1000	mW
	Derate above 25°C	8.0	$\text{mW}/^\circ\text{C}$
$R_{\theta JA}$	Thermal Resistance, Junction to Ambient		
	Effective 4 Die	125	$^\circ\text{C}/\text{W}$
	Each Die	240	$^\circ\text{C}/\text{W}$

Typical Characteristics

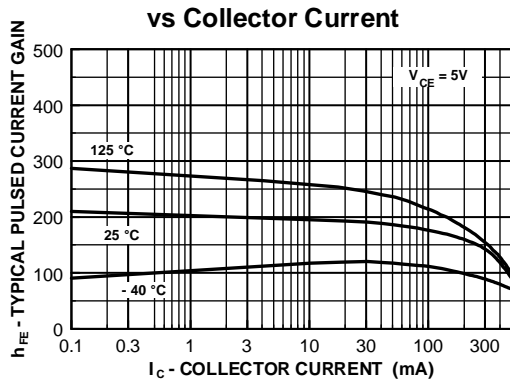

Figure 1. Typical Pulsed Current Gain vs Collector Current

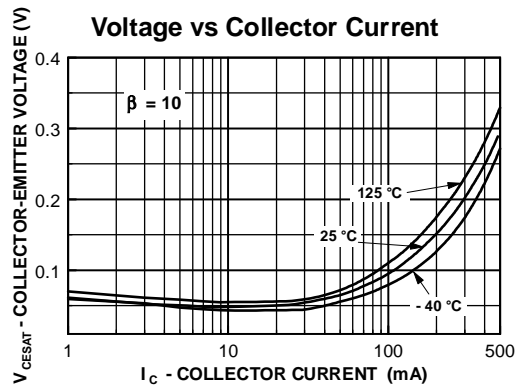

Figure 2. Collector-Emitter Saturation Voltage vs Collector Current

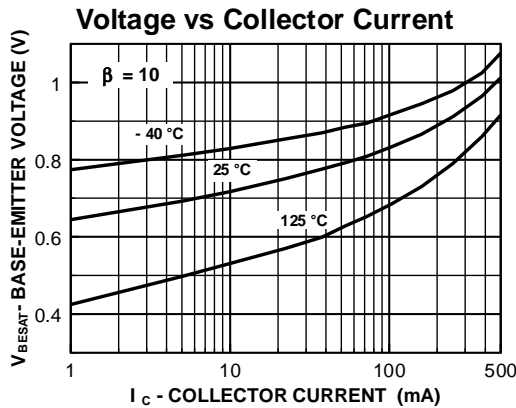

Figure 3. Base-Emitter Saturation Voltage vs Collector Current

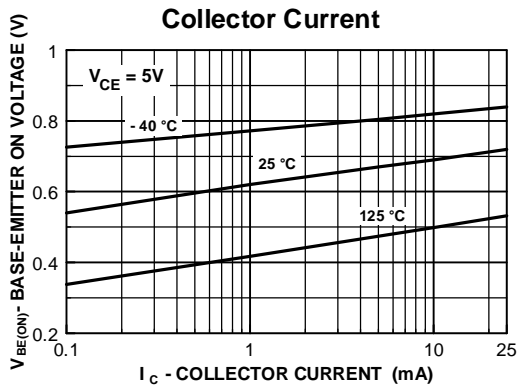

Figure 4. Base-Emitter On Voltage vs Collector Current

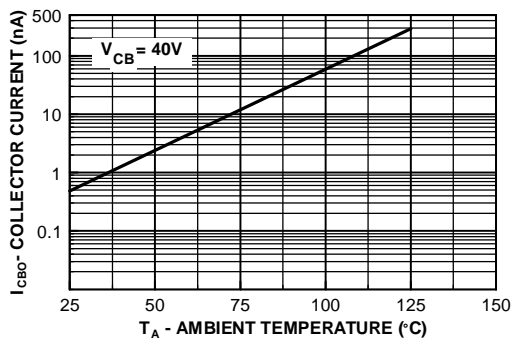

Figure 5. Collector Cutoff Current vs Ambient Temperature

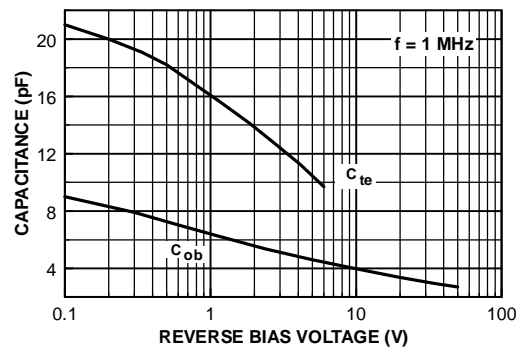

Figure 6. Emitter Transition and Output Capacitance vs Reverse Bias Voltage

Typical Characteristics (Continued)

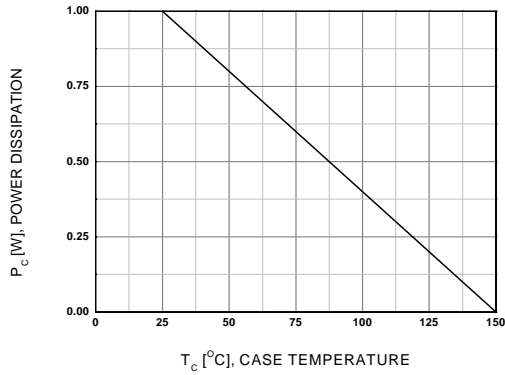

Figure 7. Power Dissipation vs Ambient Temperature

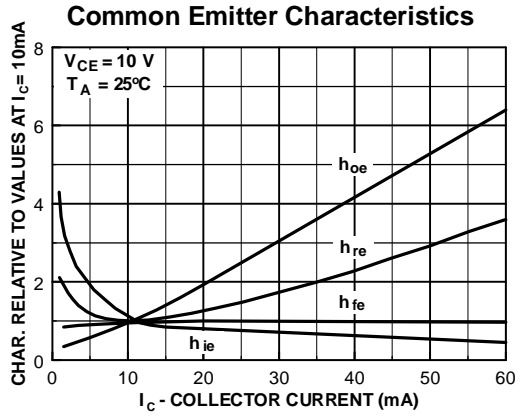

Figure 8. Common Emitter Characteristics

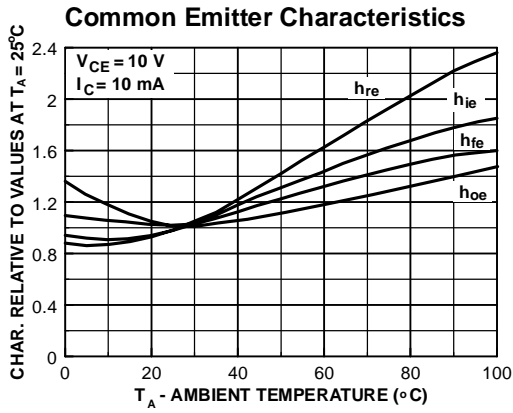

Figure 9. Common Emitter Characteristics

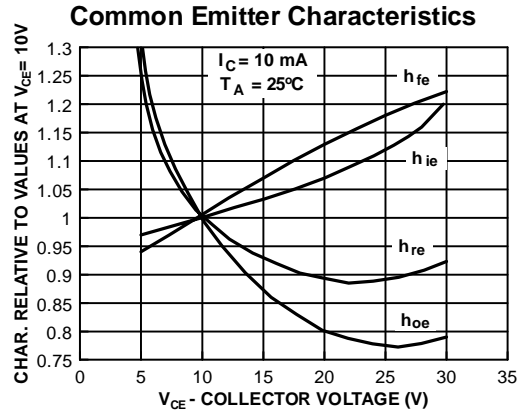

Figure 10. Common Emitter Characteristics

Test Circuit

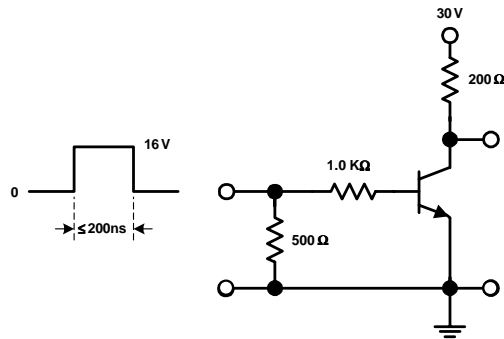

Figure 1. Saturated Turn-On Switching Time

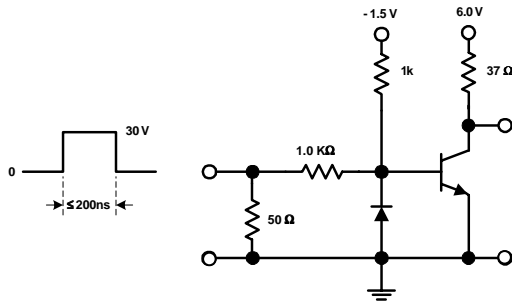
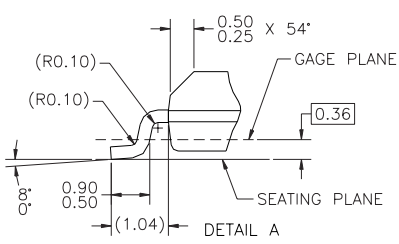
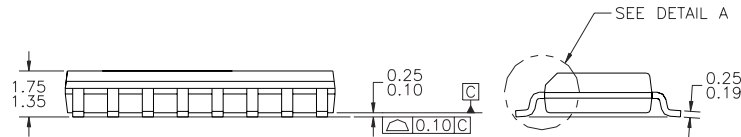
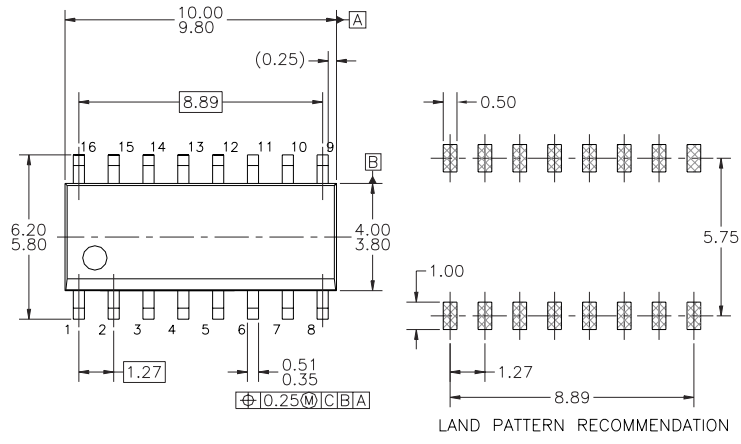

Figure 2. Saturated Turn-Off Switching Time

Package Dimensions

SOIC-16



- NOTES: UNLESS OTHERWISE SPECIFIED
- A) THIS PACKAGE CONFORMS TO JEDEC MS-012, VARIATION AC, ISSUE C, DATED MAY 1990.
 - B) ALL DIMENSIONS ARE IN MILLIMETERS.
 - C) STANDARD LEAD FINISH:
200 MICRONS / 5.08 MICRONS MIN. LEAD/TIN (SOLDER) ON COPPER.

Dimensions in Millimeters

TRADEMARKS

The following are registered and unregistered trademarks Fairchild Semiconductor owns or is authorized to use and is not intended to be an exhaustive list of all such trademarks.

ACE _x [™]	FAST [®]	ISOPLANAR [™]	Power247 [™]	Stealth [™]
ActiveArray [™]	FAST _r [™]	LittleFET [™]	PowerEdge [™]	SuperFET [™]
Bottomless [™]	FPS [™]	MICROCOUPLER [™]	PowerSaver [™]	SuperSOT [™] -3
CoolFET [™]	FRFET [™]	MicroFET [™]	PowerTrench [®]	SuperSOT [™] -6
CROSSVOLT [™]	GlobalOptoisolator [™]	MicroPak [™]	QFET [®]	SuperSOT [™] -8
DO _M E [™]	GTO [™]	MICROWIRE [™]	Q _S [™]	SyncFET [™]
EcoSPARK [™]	HiSeC [™]	MSX [™]	QT Optoelectronics [™]	TinyLogic [®]
E ² CMOS [™]	I ² C [™]	MSXPro [™]	Quiet Series [™]	TINYOPTO [™]
EnSigna [™]	<i>i-Lo</i> [™]	OCX [™]	RapidConfigure [™]	TruTranslation [™]
FACT [™]	ImpliedDisconnect [™]	OCXPro [™]	RapidConnect [™]	UHC [™]
FACT Quiet Series [™]		OPTOLOGIC [®]	μSerDes [™]	UltraFET [®]
Across the board. Around the world. [™]		OPTOPLANAR [™]	SILENT SWITCHER [®]	VCX [™]
The Power Franchise [®]		PACMAN [™]	SMART START [™]	
Programmable Active Droop [™]		POP [™]	SPM [™]	

DISCLAIMER

FAIRCHILD SEMICONDUCTOR RESERVES THE RIGHT TO MAKE CHANGES WITHOUT FURTHER NOTICE TO ANY PRODUCTS HEREIN TO IMPROVE RELIABILITY, FUNCTION OR DESIGN. FAIRCHILD DOES NOT ASSUME ANY LIABILITY ARISING OUT OF THE APPLICATION OR USE OF ANY PRODUCT OR CIRCUIT DESCRIBED HEREIN; NEITHER DOES IT CONVEY ANY LICENSE UNDER ITS PATENT RIGHTS, NOR THE RIGHTS OF OTHERS.

LIFE SUPPORT POLICY

FAIRCHILD'S PRODUCTS ARE NOT AUTHORIZED FOR USE AS CRITICAL COMPONENTS IN LIFE SUPPORT DEVICES OR SYSTEMS WITHOUT THE EXPRESS WRITTEN APPROVAL OF FAIRCHILD SEMICONDUCTOR CORPORATION.

As used herein:

1. Life support devices or systems are devices or systems which, (a) are intended for surgical implant into the body, or (b) support or sustain life, or (c) whose failure to perform when properly used in accordance with instructions for use provided in the labeling, can be reasonably expected to result in significant injury to the user.
2. A critical component is any component of a life support device or system whose failure to perform can be reasonably expected to cause the failure of the life support device or system, or to affect its safety or effectiveness.

PRODUCT STATUS DEFINITIONS

Definition of Terms

Datasheet Identification	Product Status	Definition
Advance Information	Formative or In Design	This datasheet contains the design specifications for product development. Specifications may change in any manner without notice.
Preliminary	First Production	This datasheet contains preliminary data, and supplementary data will be published at a later date. Fairchild Semiconductor reserves the right to make changes at any time without notice in order to improve design.
No Identification Needed	Full Production	This datasheet contains final specifications. Fairchild Semiconductor reserves the right to make changes at any time without notice in order to improve design.
Obsolete	Not In Production	This datasheet contains specifications on a product that has been discontinued by Fairchild semiconductor. The datasheet is printed for reference information only.