

## IR Receiver Modules for Remote Control Systems



20953

### LINKS TO ADDITIONAL RESOURCES



### DESCRIPTION

The TSOP95... series devices are the latest generation miniaturized IR receiver modules for infrared remote control systems. These series provide improvements in sensitivity to remote control signals in dark ambient as well as in sensitivity in the presence of optical disturbances e.g. from CFLs.

The devices contain a PIN diode and a preamplifier assembled on a lead frame. The epoxy package contains an IR filter. The demodulated output signal can be directly connected to a microprocessor for decoding.

The TSOP952.. and TSOP954... series devices are designed to receive long burst codes (10 or more carrier cycles per burst). The third digit designates the AGC level (AGC2 or AGC4) and the last two digits designate the band-pass frequency (see table below). The higher the AGC, the better noise is suppressed, but the lower the code compatibility. AGC2 provides basic noise suppression and AGC4 provides enhanced noise suppression. Generally, we advise to select the highest AGC that satisfactorily receives the desired remote code.

These components have not been qualified to automotive specifications.

### FEATURES

- Improved dark sensitivity
- Improved immunity against optical noise
- Very low supply current
- Photo detector and preamplifier in one package
- Internal filter for PCM frequency
- Supply voltage: 2.0 V to 3.6 V
- Insensitive to supply voltage ripple and noise
- Material categorization:  
for definitions of compliance please see [www.vishay.com/doc?99912](http://www.vishay.com/doc?99912)



### MECHANICAL DATA

 1, 4 = GND, 2 =  $V_S$ , 3 = OUT

### ORDERING CODE

#### Taping:

TSOP95...TT - top view taped, 2200 pcs/reel

TSOP95...TR - side view taped, 2300 pcs/reel

### BLOCK DIAGRAM

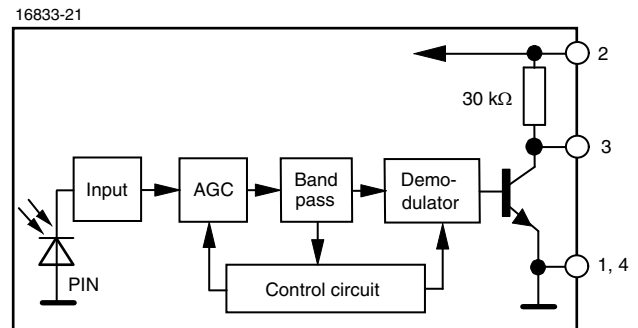

### APPLICATION CIRCUIT

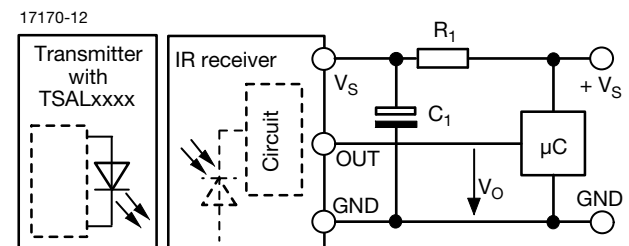
 $R_1$  and  $C_1$  recommended to reduce supply ripple for  $V_S < 2.2\text{ V}$



| PARTS TABLE       |        |  |                                   |
|-------------------|--------|--|-----------------------------------|
| AGC               |        | BASIC NOISE SUPPRESSION (AGC2)   | ENHANCED NOISE SUPPRESSION (AGC4) |
| Carrier frequency | 30 kHz | TSOP95230  | TSOP95430                         |
|                   | 33 kHz | TSOP95233  | TSOP95433                         |
|                   | 36 kHz | TSOP95236  | TSOP95436 (2)(7)                  |
|                   | 38 kHz | TSOP95238  | TSOP95438 (10)                    |
|                   | 40 kHz | TSOP95240 (12)   | TSOP95440                         |
|                   | 56 kHz | TSOP95256 (1)  | TSOP95456 (8)(9)                  |
| Package           |        | Heimdall   |                                   |
| Pinning           |        | 1, 4 = GND, 2 = V <sub>S</sub> , 3 = OUT   |                                   |
| Dimensions (mm)   |        | 6.8 W x 3.0 H x 3.2 D  |                                   |
| Mounting          |        | SMD  |                                   |
| Application       |        | Remote control   |                                   |
| Best choice for   |        | (1) Cisco (2) MCIR (3) Mitsubishi (4) NEC (5) Panasonic (6) RC-5 (7) RC-6 (8) RCA (9) r-step (10) Sejin 4PPM (11) Sharp (12) Sony  |                                   |
| Special options   |        | <ul style="list-style-type: none"> <li>Extended temperature range: <a href="http://www.vishay.com/doc?82738">www.vishay.com/doc?82738</a></li> <li>Narrow optical filter: <a href="http://www.vishay.com/doc?81590">www.vishay.com/doc?81590</a></li> <li>Wide optical filter: <a href="http://www.vishay.com/doc?82726">www.vishay.com/doc?82726</a></li> </ul> |                                   |

Notes

- 30 kHz and 33 kHz only available on written request
- See datasheet for TSOP956.. for preferred devices for (3)(4)(5)(6)(11)

| ABSOLUTE MAXIMUM RATINGS    |                          |                  |                                |      |
|-----------------------------|--------------------------|------------------|--------------------------------|------|
| PARAMETER                   | TEST CONDITION           | SYMBOL           | VALUE                          | UNIT |
| Supply voltage              |                          | V <sub>S</sub>   | -0.3 to +3.6                   | V    |
| Supply current              |                          | I <sub>S</sub>   | 3                              | mA   |
| Output voltage              |                          | V <sub>O</sub>   | -0.3 to (V <sub>S</sub> + 0.3) | V    |
| Output current              |                          | I <sub>O</sub>   | 5                              | mA   |
| Junction temperature        |                          | T <sub>j</sub>   | 100                            | °C   |
| Storage temperature range   |                          | T <sub>stg</sub> | -25 to +85                     | °C   |
| Operating temperature range |                          | T <sub>amb</sub> | -25 to +85                     | °C   |
| Power consumption           | T <sub>amb</sub> ≤ 85 °C | P <sub>tot</sub> | 10                             | mW   |

Note

- Stresses beyond those listed under “Absolute Maximum Ratings” may cause permanent damage to the device. This is a stress rating only and functional operation of the device at these or any other conditions beyond those indicated in the operational sections of this specification is not implied. Exposure to absolute maximum rating conditions for extended periods may affect the device reliability

| ELECTRICAL AND OPTICAL CHARACTERISTICS (T <sub>amb</sub> = 25 °C, unless otherwise specified) |  |                     |      |      |      |                   |
|---|--|---------------------|------|------|------|-------------------|
| PARAMETER   | TEST CONDITION   | SYMBOL              | MIN. | TYP. | MAX. | UNIT              |
| Supply current  | E <sub>v</sub> = 0, V <sub>S</sub> = 3.3 V   | I <sub>SD</sub>     | 0.25 | 0.37 | 0.45 | mA                |
|   | E <sub>v</sub> = 40 klx, sunlight  | I <sub>SH</sub>     | -    | 0.50 | -    | mA                |
| Supply voltage  |  | V <sub>S</sub>      | 2.0  | -    | 3.6  | V                 |
| Transmission distance   | E <sub>v</sub> = 0, test signal see Fig. 1, IR diode TSAL6200, I <sub>F</sub> = 50 mA                              | d                   | -    | 25   | -    | m                 |
| Output voltage low  | I <sub>OSL</sub> = 0.5 mA, E <sub>e</sub> = 0.7 mW/m <sup>2</sup> , test signal see Fig. 1                         | V <sub>OSL</sub>    | -    | -    | 100  | mV                |
| Minimum irradiance  | Test signal: NEC code  | E <sub>e min.</sub> | -    | 0.11 | 0.25 | mW/m <sup>2</sup> |
| Maximum irradiance  | t <sub>pi</sub> - 4/f <sub>0</sub> < t <sub>po</sub> < t <sub>pi</sub> + 4/f <sub>0</sub> , test signal see Fig. 1 | E <sub>e max.</sub> | 30   | -    | -    | W/m <sup>2</sup>  |
| Directivity   | Angle of half transmission distance  | φ <sub>1/2</sub>    | -    | ± 50 | -    | °                 |

## TYPICAL CHARACTERISTICS (T<sub>amb</sub> = 25 °C, unless otherwise specified)

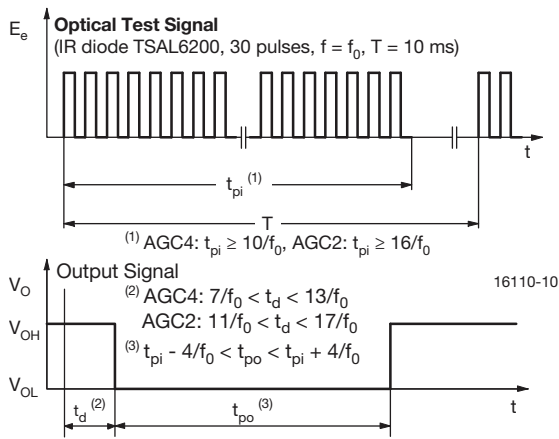

Fig. 1 - Output Delay and Pulse-Width

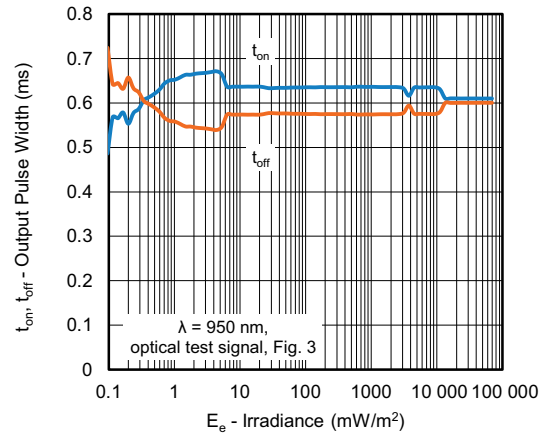

Fig. 4 - Pulse-Width vs. Irradiance in Dark Ambient

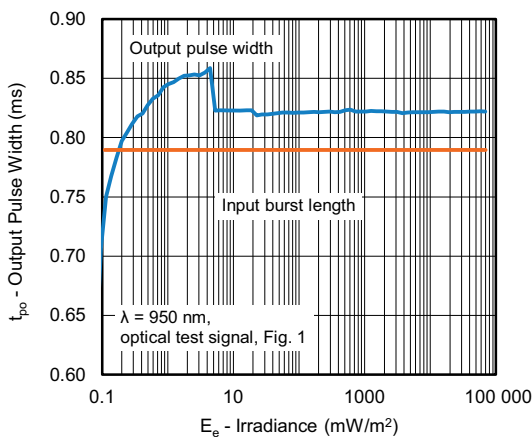

Fig. 2 - Pulse-Width vs. Irradiance in Dark Ambient

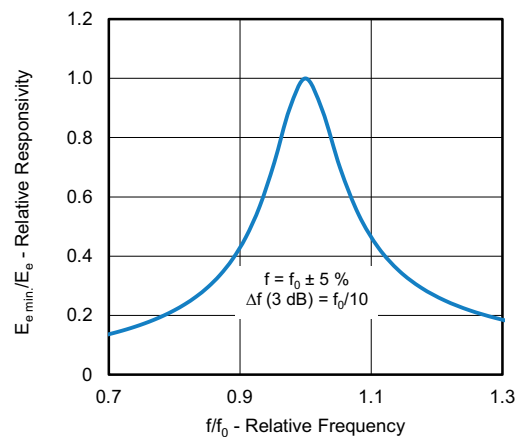

Fig. 5 - Frequency Dependence of Responsivity

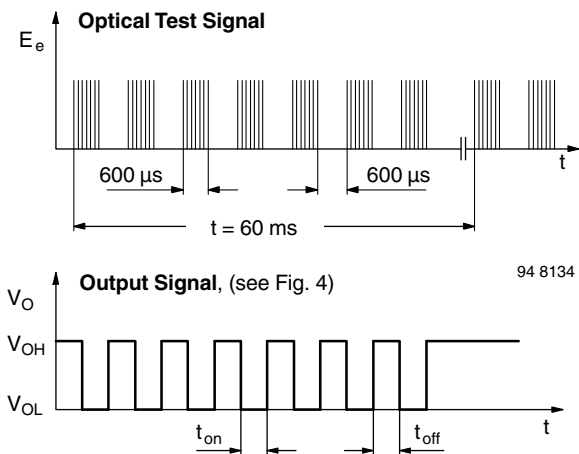

Fig. 3 - Test Signal

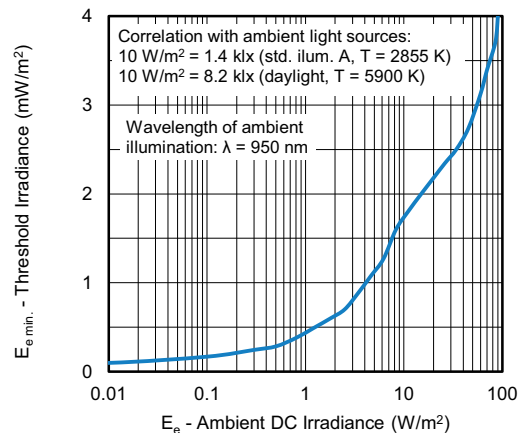

Fig. 6 - Sensitivity in Bright Ambient

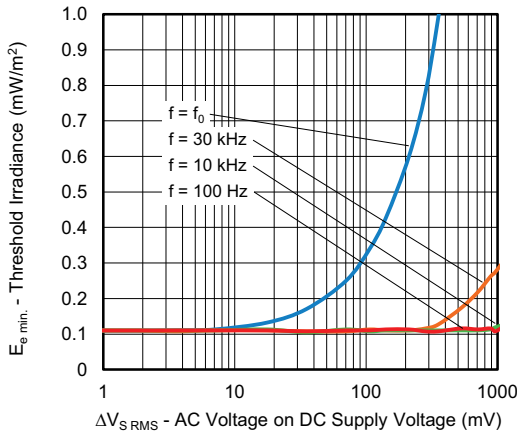

Fig. 7 - Sensitivity vs. Supply Voltage Disturbances

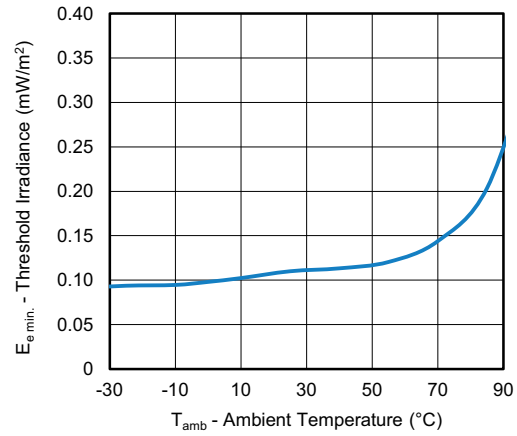

Fig. 9 - Sensitivity vs. Ambient Temperature

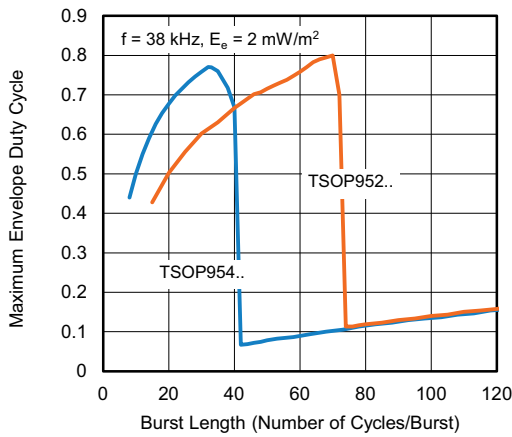

Fig. 8 - Max. Envelope Duty Cycle vs. Burst Length



Fig. 10 - Relative Spectral Sensitivity vs. Wavelength

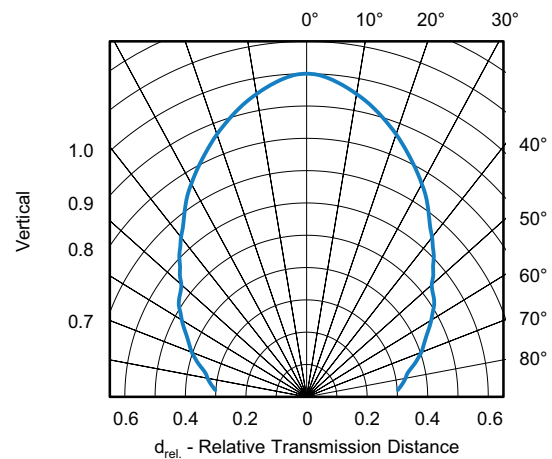
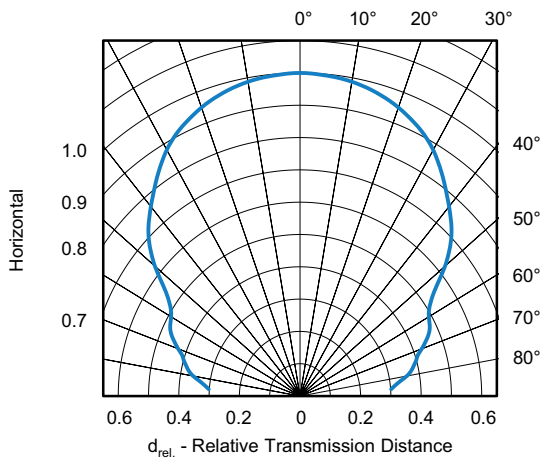

Fig. 11 - Horizontal and Vertical Directivity

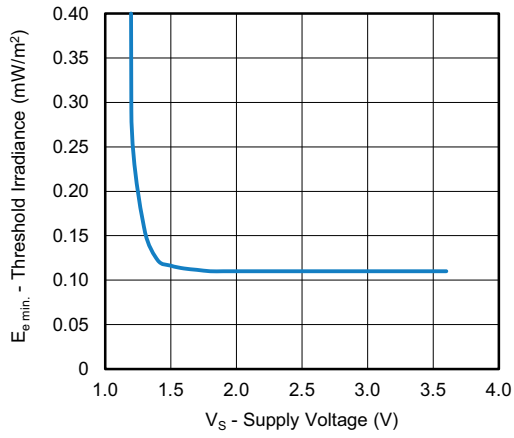

Fig. 12 - Sensitivity vs. Supply Voltage

**SUITABLE DATA FORMAT**

This series is designed to suppress spurious output pulses due to noise or disturbance signals. The devices can distinguish data signals from noise due to differences in frequency, burst length, and envelope duty cycle. The data signal should be close to the device's band-pass center frequency (e.g. 38 kHz) and fulfill the conditions in the table below.

When a data signal is applied to the product in the presence of a disturbance, the sensitivity of the receiver is automatically reduced by the AGC to insure that no spurious pulses are present at the receiver's output. Some examples which are suppressed are:

- DC light (e.g. from tungsten bulbs sunlight)
- Continuous signals at any frequency
- Strongly or weakly modulated patterns from fluorescent lamps with electronic ballasts (see Fig. 13 or Fig. 14)



Fig. 13 - IR Emission from Fluorescent Lamp With Low Modulation



Fig. 14 - IR Emission from Fluorescent Lamp With High Modulation

|  | <b>TSOP952..</b>                | <b>TSOP954..</b>                 |
|--|---------------------------------|----------------------------------|
| Minimum burst length   | 16 cycles/burst                 | 10 cycles/burst                  |
| After each burst of length a minimum gap time is required of               | 16 to 70 cycles<br>≥ 16 cycles  | 10 to 40 cycles<br>≥ 12 cycles   |
| For bursts greater than a minimum gap time in the data stream is needed of | 70 cycles<br>> 6 x burst length | 40 cycles<br>> 10 x burst length |
| Maximum number of continuous short bursts/second                           | 1000                            | 1800                             |
| RC-5 code  | Yes                             | Yes                              |
| RC-6 code  | Yes                             | Preferred                        |
| NEC code   | Yes                             | Yes                              |
| r-step code 56 kHz   | No                              | Preferred                        |
| Sony code  | Preferred                       | No                               |
| RCA 56 kHz code  | Yes                             | Preferred                        |
| Mitsubishi code 38 kHz   | Yes                             | Yes                              |
| Suppression of interference from fluorescent lamps                         | Fig. 13                         | Fig. 13 and Fig. 14              |

**Note**

- For data formats with short bursts please see the datasheet for TSOP953.., TSOP955..

**PACKAGE DIMENSIONS** in millimeters



**ASSEMBLY INSTRUCTIONS**

**Reflow Soldering**

- Reflow soldering must be done within 72 h while stored under a max. temperature of 30 °C, 60 % RH after opening the dry pack envelope
- Set the furnace temperatures for pre-heating and heating in accordance with the reflow temperature profile as shown in the diagram. Exercise extreme care to keep the maximum temperature below 260 °C. The temperature shown in the profile means the temperature at the device surface. Since there is a temperature difference between the component and the circuit board, it should be verified that the temperature of the device is accurately being measured
- Handling after reflow should be done only after the work surface has been cooled off

**Manual Soldering**

- Use a soldering iron of 25 W or less. Adjust the temperature of the soldering iron below 300 °C
- Finish soldering within 3 s
- Handle products only after the temperature has cooled off



VISHAY LEAD (Pb)-FREE REFLOW SOLDER PROFILE

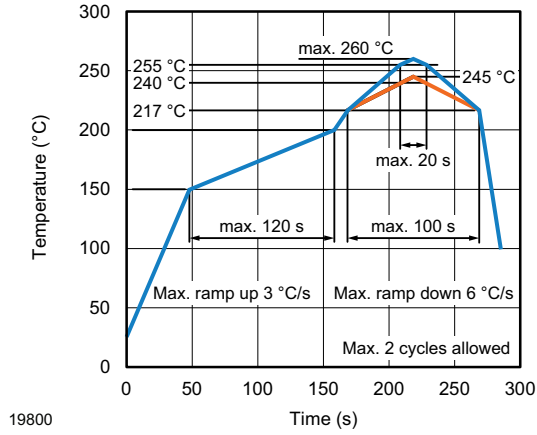

TAPING VERSION TSOP..TR DIMENSIONS in millimeters

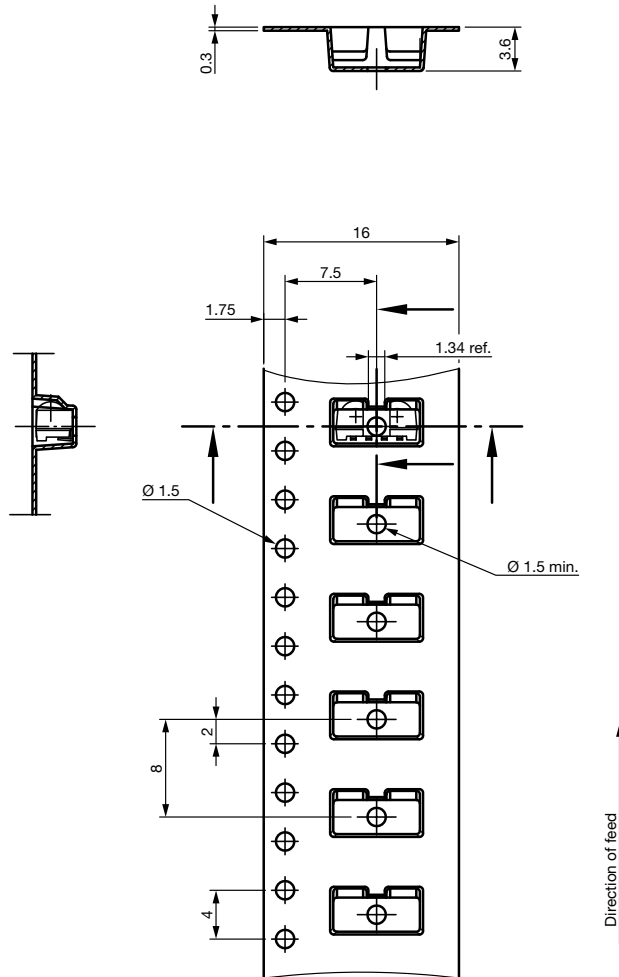

Drawing-No.: 9.700-5337.01-4  
Issue: 2; 06.10.15

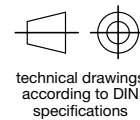





## TAPING VERSION TSOP..TT DIMENSIONS in millimeters



Drawing-No.: 9.700-5338.01-4  
Issue: 4; 12.06.13



technical drawings  
according to DIN  
specifications

**REEL DIMENSIONS** in millimeters

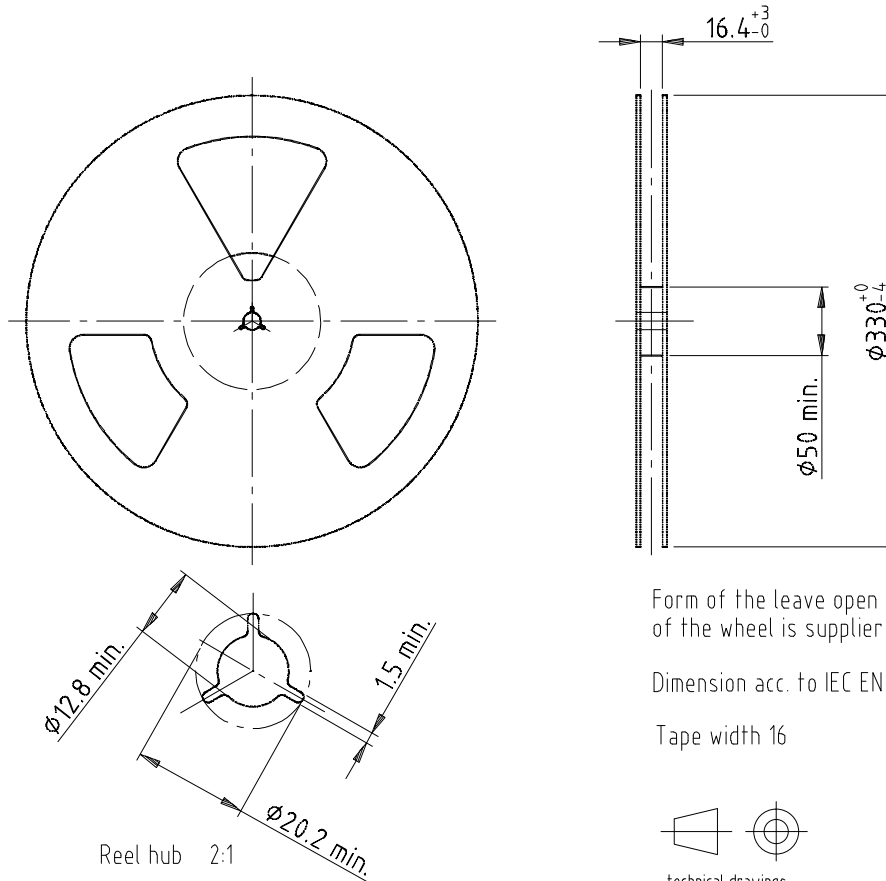

Form of the leave open of the wheel is supplier specific.

Dimension acc. to IEC EN 60 286-3

Tape width 16

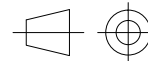

technical drawings according to DIN specifications

Drawing-No.: 9.800-5052.V2-4

Issue: 1; 07.05.02

16734

**LEADER AND TRAILER DIMENSIONS** in millimeters



**COVER TAPE PEEL STRENGTH**

According to DIN EN 60286-3

0.1 N to 1.3 N

300 ± 10 mm/min.

165° to 180° peel angle

**LABEL**

**Standard bar code labels for finished goods**

The standard bar code labels are product labels and used for identification of goods. The finished goods are packed in final packing area. The standard packing units are labeled with standard bar code labels before transported as finished goods to warehouses. The labels are on each packing unit and contain Vishay Semiconductor GmbH specific data.

| <b>VISHAY SEMICONDUCTOR GmbH STANDARD BAR CODE PRODUCT LABEL (finished goods)</b> |                     |               |
|---|---------------------|---------------|
| <b>PLAIN WRITING</b>  | <b>ABBREVIATION</b> | <b>LENGTH</b> |
| Item-description  | -                   | 18            |
| Item-number   | INO                 | 8             |
| Selection-code  | SEL                 | 3             |
| LOT-/serial-number  | BATCH               | 10            |
| Data-code   | COD                 | 3 (YWW)       |
| Plant-code  | PTC                 | 2             |
| Quantity  | QTY                 | 8             |
| Accepted by   | ACC                 | -             |
| Packed by   | PCK                 | -             |
| Mixed code indicator  | MIXED CODE          | -             |
| Origin  | xxxxxxx+            | Company logo  |
| <b>Long bar code top</b>  | <b>Type</b>         | <b>Length</b> |
| Item-number   | N                   | 8             |
| Plant-code  | N                   | 2             |
| Sequence-number   | X                   | 3             |
| Quantity  | N                   | 8             |
| Total length  | -                   | 21            |
| <b>Short bar code bottom</b>  | <b>Type</b>         | <b>Length</b> |
| Selection-code  | X                   | 3             |
| Data-code   | N                   | 3             |
| Batch-number  | X                   | 10            |
| Filter  | -                   | 1             |
| Total length  | -                   | 17            |

### DRY PACKING

The reel is packed in an anti-humidity bag to protect the devices from absorbing moisture during transportation and storage.

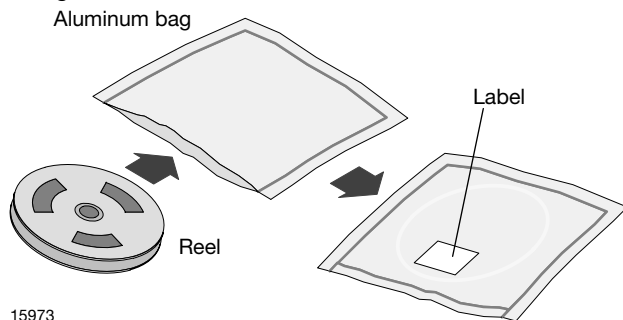

### FINAL PACKING

The sealed reel is packed into a cardboard box.

### RECOMMENDED METHOD OF STORAGE

Dry box storage is recommended as soon as the aluminum bag has been opened to prevent moisture absorption. The following conditions should be observed, if dry boxes are not available:

- Storage temperature 10 °C to 30 °C
- Storage humidity ≤ 60 % RH max.

After more than 72 h under these conditions moisture content will be too high for reflow soldering.

In case of moisture absorption, the devices will recover to the former condition by drying under the following condition:  
 192 h at 40 °C + 5 °C / - 0 °C and < 5 % RH (dry air / nitrogen) or  
 96 h at 60 °C + 5 °C and < 5 % RH for all device containers or  
 24 h at 125 °C + 5 °C not suitable for reel or tubes.

An EIA JEDEC® standard J-STD-020 level 4 label is included on all dry bags.

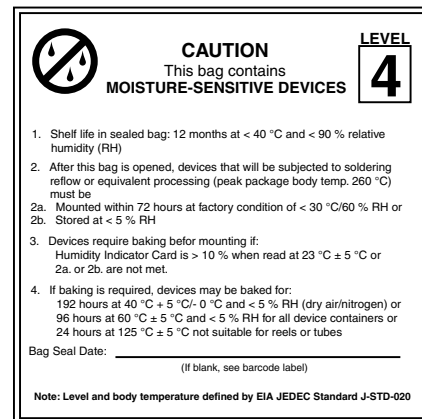

EIA JEDEC standard J-STD-020 level 4 label is included on all dry bags



### OUTER PACKAGING

The sealed reel is packed into a pizza box.

| CARTON BOX DIMENSIONS in millimeters              |           |       |        |
|---|-----------|-------|--------|
|   |           |       |        |
| 22127   |           |       |        |
|   | THICKNESS | WIDTH | LENGTH |
| Pizza box (SMD and heimdall)<br>(taping in reels) | 50        | 340   | 340    |

### ESD PRECAUTION

Proper storage and handling procedures should be followed to prevent ESD damage to the devices especially when they are removed from the antistatic shielding bag. Electrostatic sensitive devices warning labels are on the packaging.

### VISHAY SEMICONDUCTORS STANDARD BAR CODE LABELS

The Vishay Semiconductors standard bar code labels are printed at final packing areas. The labels are on each packing unit and contain Vishay Semiconductors specific data.

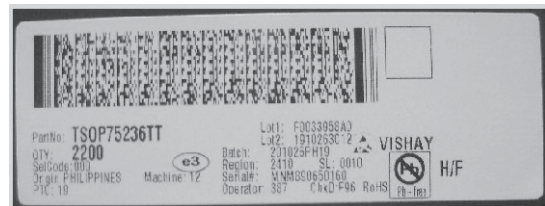

22178



## Disclaimer

ALL PRODUCT, PRODUCT SPECIFICATIONS AND DATA ARE SUBJECT TO CHANGE WITHOUT NOTICE TO IMPROVE RELIABILITY, FUNCTION OR DESIGN OR OTHERWISE.

Vishay Intertechnology, Inc., its affiliates, agents, and employees, and all persons acting on its or their behalf (collectively, "Vishay"), disclaim any and all liability for any errors, inaccuracies or incompleteness contained in any datasheet or in any other disclosure relating to any product.

Vishay makes no warranty, representation or guarantee regarding the suitability of the products for any particular purpose or the continuing production of any product. To the maximum extent permitted by applicable law, Vishay disclaims (i) any and all liability arising out of the application or use of any product, (ii) any and all liability, including without limitation special, consequential or incidental damages, and (iii) any and all implied warranties, including warranties of fitness for particular purpose, non-infringement and merchantability.

Statements regarding the suitability of products for certain types of applications are based on Vishay's knowledge of typical requirements that are often placed on Vishay products in generic applications. Such statements are not binding statements about the suitability of products for a particular application. It is the customer's responsibility to validate that a particular product with the properties described in the product specification is suitable for use in a particular application. Parameters provided in datasheets and / or specifications may vary in different applications and performance may vary over time. All operating parameters, including typical parameters, must be validated for each customer application by the customer's technical experts. Product specifications do not expand or otherwise modify Vishay's terms and conditions of purchase, including but not limited to the warranty expressed therein.

Hyperlinks included in this datasheet may direct users to third-party websites. These links are provided as a convenience and for informational purposes only. Inclusion of these hyperlinks does not constitute an endorsement or an approval by Vishay of any of the products, services or opinions of the corporation, organization or individual associated with the third-party website. Vishay disclaims any and all liability and bears no responsibility for the accuracy, legality or content of the third-party website or for that of subsequent links.

Except as expressly indicated in writing, Vishay products are not designed for use in medical, life-saving, or life-sustaining applications or for any other application in which the failure of the Vishay product could result in personal injury or death. Customers using or selling Vishay products not expressly indicated for use in such applications do so at their own risk. Please contact authorized Vishay personnel to obtain written terms and conditions regarding products designed for such applications.

No license, express or implied, by estoppel or otherwise, to any intellectual property rights is granted by this document or by any conduct of Vishay. Product names and markings noted herein may be trademarks of their respective owners.