

GN 139.1

with Integrated Safety Switch

GN 139.2

without Switch

Hinges

Zinc Die-Cast



JWWINCO[®]

A Ganter Company

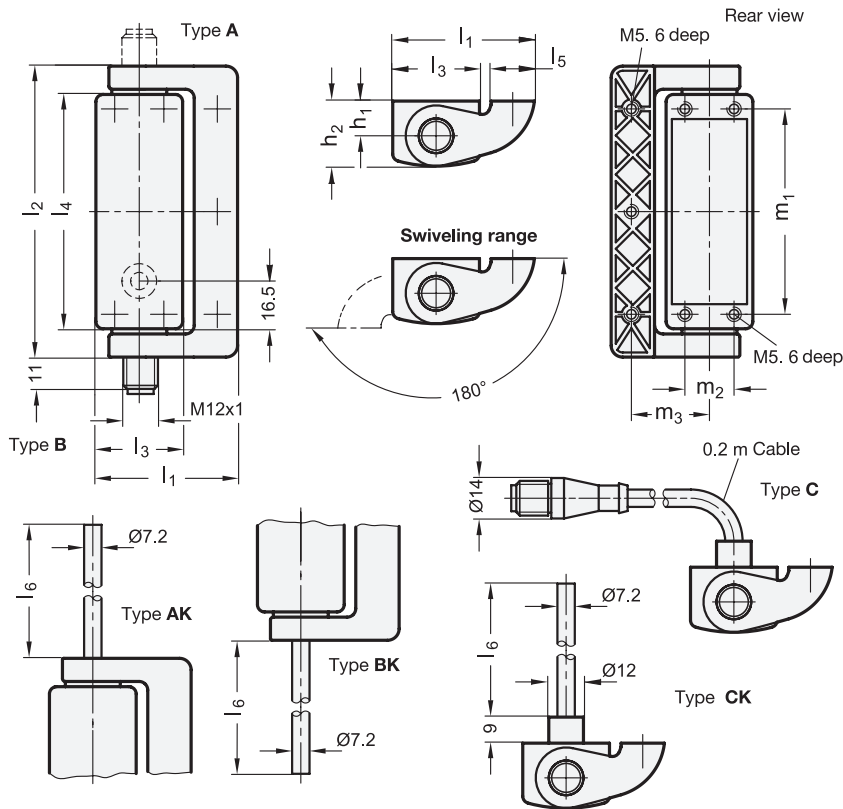

3 Type

- A** Connector plug at the top
- B** Connector plug at the bottom
- C** Connector plug at the backside (with 0.2 m cable)
- AK** Cable at the top
- BK** Cable at the bottom
- CK** Cable at the backside

Metric table

1		2						4		Dimensions in: millimeters - inches					
l ₁	l ₂	l ₃	l ₄	l ₅	l ₆	h ₁	h ₂	m ₁	m ₂	m ₃					
Small hinge wing	Broad hinge wing			Small hinge wing	Broad hinge wing	Cable length in meters (Type AK / BK / CK)					Small hinge wing	Broad hinge wing			
49	79	101	30	81	15	30	2	5	12	22.5	71	17	27	50	
1.93	3.11	3.98	1.18	3.19	0.59	1.18			0.47	0.89	2.80	0.67	1.06	1.97	

Specification

- Body
Zinc die-cast
Powder coated
Silver metallic finish
- Pin
Stainless steel AISI 303
- *Stainless Steel Characteristics* → page 2143
- **RoHS compliant**

Accessory

- Cables with connector coupling → page 1436
8-pole, 5 or 10 meters long:
 - GN 330-M12x1-8-G-5
 - GN 330-M12x1-8-G-10
- Mounting plates GN 139.3 / GN 139.4
→ page 1426 / 1426

On request

- Hinges with operating angle > 0°
- Hinges with other contact load ratings

Information

GN 139.1 hinges with integrated safety switch are designed for use on monitoring doors and covers of machines and equipment. Opening the door activates the switch contacts. This causes an interruption in a protective circuit via broken contact (NC) and at the same time signals the door opening by closing a normally open contact element (NO).

The contact blocks include positive opening slow-action contacts, i.e. they will definitely be separated when activated and have no hysteresis. The angle at which the switching points are reached is adjustable.

The compact construction combines safety with an attractive design. The hinges are tamper-proof because of the covered mounting from the backside.

GN 139.2 hinges without switch are designed to be used in conjunction with GN 139.1 hinges with integrated safety switch, in applications with larger doors or gates where several hinges are required.

see also...

- *List of Hinge Types* → page 1324

How to order (With integrated safety switch)



GN 139.1-49-101-AK-5

- 1 Width l₁
- 2 Length l₂
- 3 Type
- 4 Cable length l₆

How to order (Without switch)

GN 139.2-79-101

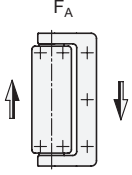
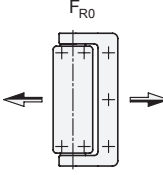
- 1 Width l₁
- 2 Length l₂

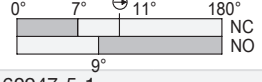
Mechanical features				
Maximum load Information with safety factor	Load direction			
	$l_1 = 49 \text{ mm}$	1500 N 337.21 lbf	1000 N 224.81 lbf	1000 N 224.81 lbf
Examples of calculation → see operating instruction	$l_1 = 79 \text{ mm}$	750 N 168.61 lbf	500 N 112.40 lbf	500 N 112.40 lbf
Assembly	From the backside, 7 x thread M5, 6 mm deep			
Recommended torque	5 Nm (Screws M5)			
Protection class	IP67 / IP69K (Mind the cable conduit!)	acc. to EN 60529		
Switching principle, contact opening	Slow-action contacts force-fitted, with positive opening	acc. to IEC 60947-5-1, K		
Contact material	Silver alloy			
Operating travel diagram (scheme)	The switching points are adjustable up to 4° in direction of 0°. → see operating instruction			
Maximum operating frequency	600 operating cycles / hour	acc. to IEC 60947-5-1,		
Mechanical life span	10 ⁶ operating cycles	one operating cycle includes one opening and one closing action		
Actuating speed	min. 2° / second, max. 90° / second			

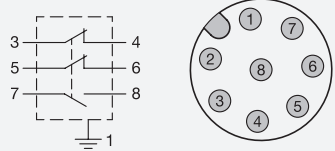
Electrical features / Safety features		
Utilization category	AC 15: 24 V AC / 2A / DC 13: 24 V DC / 2A (connector plug) AC 15: 250 V AC / 4A / DC 13: 250 V DC / 0.3 A (cable)	acc. to EN 60947-5-1
Contact, termination 8-pole connector M12 or cable with 2 m or 5 m length		1 - green-yellow 3 - black 5 - red 7 - brown 4 - black-white 6 - red-white 8 - blue
Pin and cable assignment		
Type of cable	Type N 7x0.5 mm ² , jacket PVC H05VV-F	acc. to IEC 60332-1-2 et seqq.
Short-circuit current	1000 A	acc. to EN 60947-5-1
Rated insulation voltage	30 V AC / 36 V DC (connector plug) / 250 V AC (cable)	
Short-circuit protection	2 A, 500 V, Type gG (connector plug) / 6 A, 500 V, Type gG (cable)	
Ambient temperature	-13 °F up to +176 °F (- 25 °C up to + 80 °C)	
Degree of pollution, external	3	acc. to EN 60947-5-1
Mission time (T_M)	20 years	acc. to EN ISO 13849-1
Number of cycles (B10 d)	5 000 000	acc. to EN 61820-2

Approvals, conformities, applicability		
Low-voltage switchgear and control-gear CE declaration IMQ: CA02.03746 UL: E 131787		EN 60947-1/2007 EN 60947-1-5 : 2004 + A1/2009
Safety applications	up to SIL 3 / PL e	acc. to EN ISO 13849-1

Other important details and hints are given in the operating instruction for GN 139.1 hinges which are included with every hinge and they are also available as PDF downloads from "www.jwwinco.com" under "Service".

The hinges with integrated safety switch must be mounted and commissioned by qualified technical personnel in compliance with the details given in the operating instructions and with the national / international rules and regulations along with the applicable standards. JW Winco will assume no statutory liability for missing or incorrect information and for any consequences arising therefrom.

3.1
3.2
3.3
3.4
3.5
3.6
3.7
3.8
3.9
3.10

