

ABRIDGED DATA SHEET

MAX66300-24x Evaluation Kit

Evaluates: MAX66300, MAX66242

General Description

The MAX66300-24x evaluation system (EV system) comprises a MAX66300 evaluation kit (EV kit) and a MAX66242 tag. The MAX66300 EV kit combines a RFID reader for contactless communication at 13.56MHz and a SHA-256 secure authenticator coprocessor. The RFID reader covers the ISO 15693 standard and the authenticator coprocessor is based on the FIPS 180-4 standard. The MAX66242 tag operates as a solution covering the ISO 15693 standard. By pairing the MAX66300 EV kit with the MAX66242 EV kit into an EV system, EV kit software can operate to show a secure challenge and response authentication and other part specific functionality.

MAX66300-24x EV System Content List

PART	QTY	DESCRIPTION
MAX66300 EV Kit	1	MAX66300 evaluation kit
MAX66242 Tag	1	MAX66242 tag
3021003-03	1	Qualtek USB Type A to USB Mini-Type B cable

Ordering Information appears at end of data sheet.

Features

- A Secure, Contactless RFID Reader (MAX66300)
 - 3.3V or 5V AFE Operation
 - UART and SPI Interface Support Through the MAXQ610
 - Configuration for Lower Power Systems with Direct Antenna Connections
 - On-Board 13.56MHz and 24MHz Oscillators
 - Symmetric Key-Based Secure Authentication System
 - Pushbuttons for Board Reset and MAX66300 Reset
 - Port Select Switch Control
 - Jumpers for SPI, UART, and Control Signals
- Protected Tag Solution with Peripheral Linking (MAX66242)
 - HF Interface at 13.56MHz
 - User EEPROM Authenticated Memory Page Read/Write Transactions
 - User EEPROM Page or Block Read/Write Transactions
 - Secure Transactions to Write Secret Keys and Compute MACs
 - Energy Harvested VOUT Used to Power an LED On/Off
 - I²C Communication with On-Board Temperature Sensor IC, DS75S
 - Also Supports MAX66240 without I²C Interface (Tag Not Included in EV Kit)
- MAX66300-24x EV System Software Available

ABRIDGED DATA SHEET

MAX66300-24x Evaluation Kit

Evaluates: MAX66300, MAX66242

MAX66300-24x Evaluation System



ABRIDGED DATA SHEET

MAX66300-24x Evaluation Kit

Evaluates: MAX66300, MAX66242

Quick Start

Required Equipment

- MAX66300 EV kit (included)
- MAX66242 tag (included)
- USB Type A to USB Mini Type B cable (included)
- PC with Windows® 8/8.1, Windows 7, or Windows Vista® and a spare USB port

Note: In the following sections, software-related items are identified by bolding. Text in **bold** only refers to items directly from the EV kit software. Text in **bold and underlined** refers to items from the Windows OS.

Setup Procedure

- 1) Perform the following to install the PL-2303HXD prolific driver:
 - a) Download the driver file called PL2303_Prolific_DriverInstaller.zip from http://files.maximintegrated.com/sia_bu/public/.
 - b) Unzip, **Open** and **Run** the file with the following name “PL2303_Prolific_DriverInstaller.exe”.
 - c) Follow the directions of the **Install Wizard** until **Finish** is reached for the PL-2303 USB-to-serial driver installation. Click the **Finish** button to close.
- 2) Proceed by setting up the MAX66300 EV kit hardware by doing the following:
 - a) Configure the jumpers per [Table 1](#) and [Figure 46](#) for 3.3V operation.
 - b) Set the switch SW3 per [Table 2](#) and [Figure 47](#) for UART operation when the MAX66300 powers up.
 - c) Using the USB type A to USB type Mini B cable, connect the MAX66300 EV kit’s CN1 port into a spare USB port of a PC.
- 3) Set up the MAX66242 tag hardware by doing the following:
 - a) Configure the jumpers per [Table 3](#) and [Figure 48](#).
 - b) Position the MAX66242 tag over the MAX66300 EV kit antenna.
- 4) The MAX66300 EV kit uses both the Prolific PL-2303HXD and a MAXQ610 microcontroller to provide SPI or UART connectivity to the MAX66300 device. Verify correct installation of the virtual COM port by selecting **Control Panel**→**System**→**Hardware**→**Device Manager** and expanding the **Ports (COM & LPT)**. If the driver installed properly, the “Prolific USB-to-Serial Comm Port” lists as in [Figure 1](#). Note that your COM port number can be different.

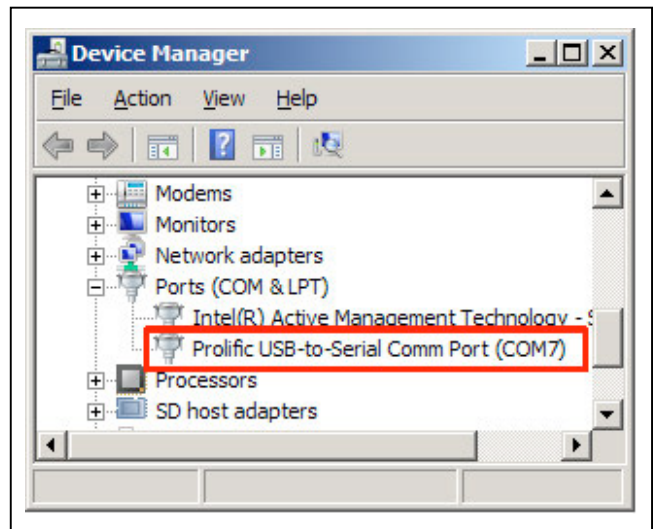

Figure 1. MAX66300 EV kit Virtual COM Port

ABRIDGED DATA SHEET

MAX66300-24x Evaluation Kit

Evaluates: MAX66300, MAX66242

- 5) Unzip the “MAX66300-24X_EV_Kit.zip” in a known location. **Note:** If you have not already obtained the software with this data sheet, request it from applications support through the following link: <https://support.maximintegrated.com>.
- 6) Open the “MAX66300-24x EV Kit” folder, as shown in [Figure 2](#) and double-click the “setup.exe”.
- 7) Now, double-click the **Install** button as shown in [Figure 3](#).
- 8) The evaluation program GUI appears as shown in [Figure 4](#).

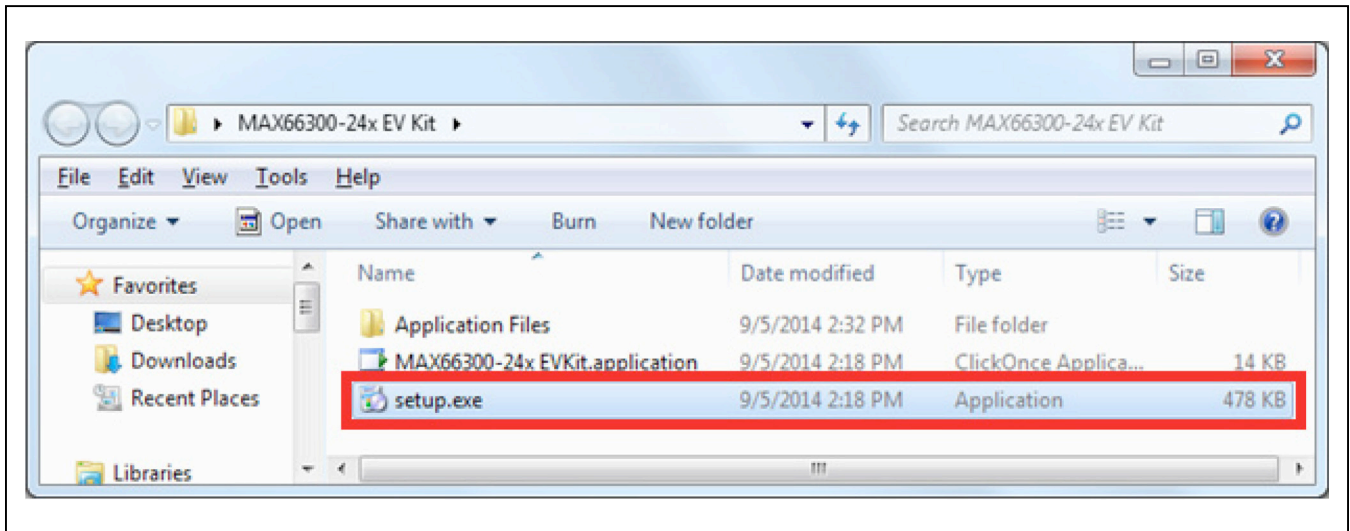

Figure 2. MAX66300-24x EV kit Setup

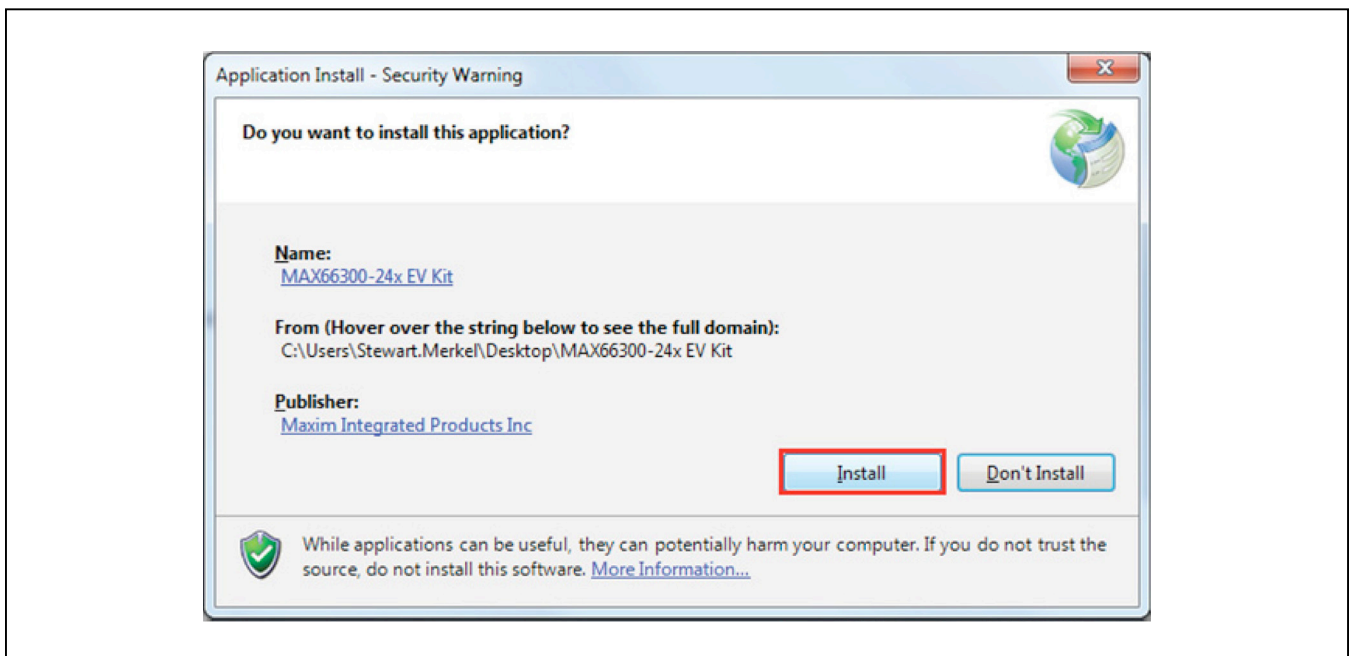

Figure 3. Application Install–Security Warning

ABRIDGED DATA SHEET

MAX66300-24x Evaluation Kit

Evaluates: MAX66300, MAX66242

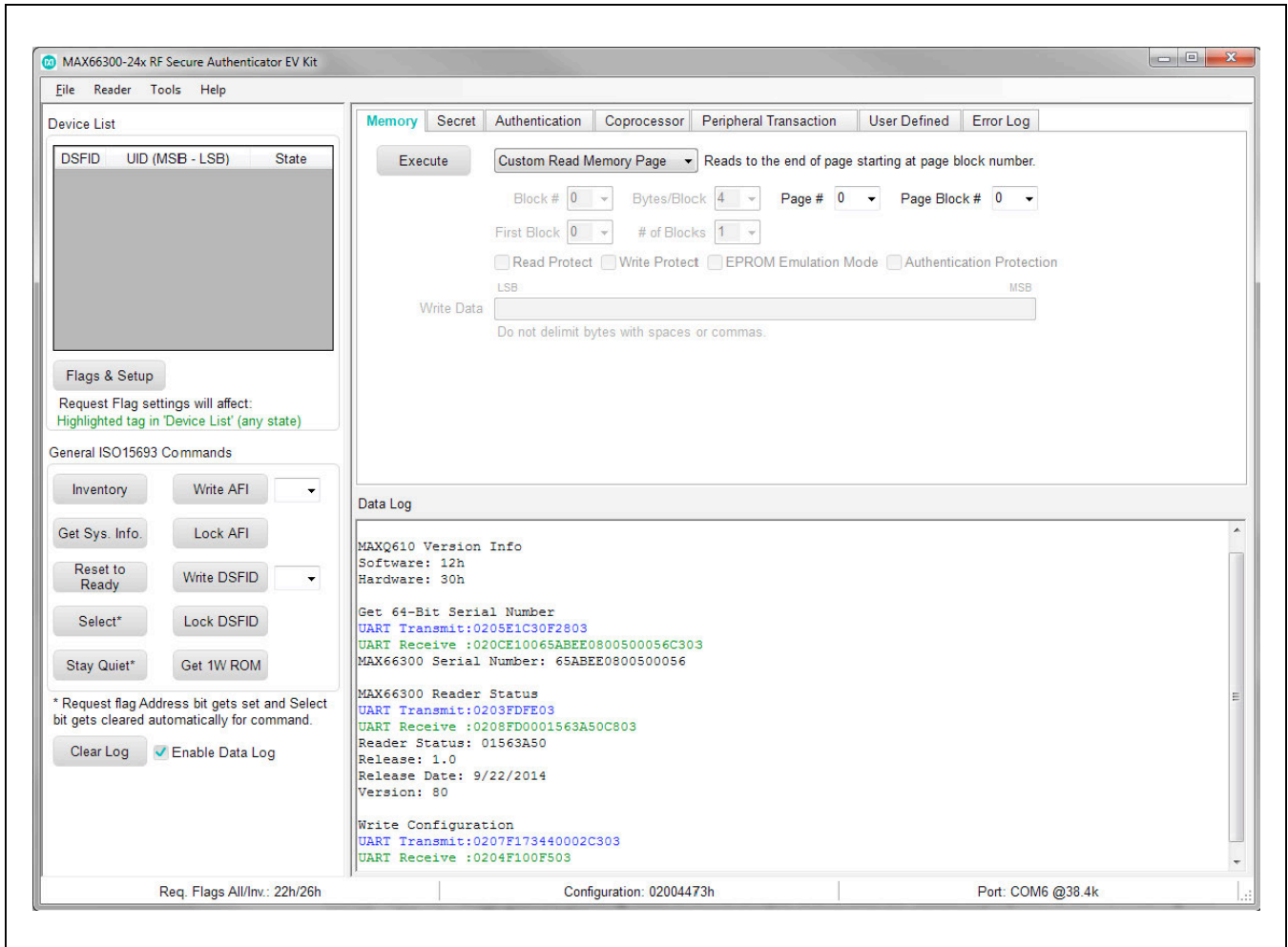

Figure 4. MAX66300-24x EV Kit GUI

ABRIDGED DATA SHEET

MAX66300-24x Evaluation Kit

Evaluates: MAX66300, MAX66242

Peripheral Transaction and User-Defined Tutorial

This tutorial involves the MAX66300 reader, the MAX66242 tag and the DS75S to show how to customize communication. The first purpose is to show how to read temperature from a DS75S I²C slave using the MAX66242 tag as the I²C master with the **Peripheral Transaction** tab. The second purpose is to show how to form a transmit packet using the **User Defined** tab.

Peripheral Transaction with DS75S

This section demonstrates how to perform I²C communication to the DS75S device contained on the MAX66242 Tag with the MAX66300 EV kit. After completing the

Quick Start section with the GUI open as in [Figure 4](#), click on rectangular red objects and confirm red circled objects for the following steps:

- 1) Click on the **Inventory** button in the **General ISO 15693 Commands** group box ([Figure 38](#)).
- 2) Confirm the UID number in the display of the **Device List** group box appears ([Figure 39](#)). **Note:** The MAX66242 tag's upper 36 bits are fixed at E02B00800h. Note: If the UID number does not show, then improve the reader distance by changing setting open the VOUT JB1 jumper (pins 13 and 14) of [Figure 8](#) that disconnects harvesting energy to power the green LED.

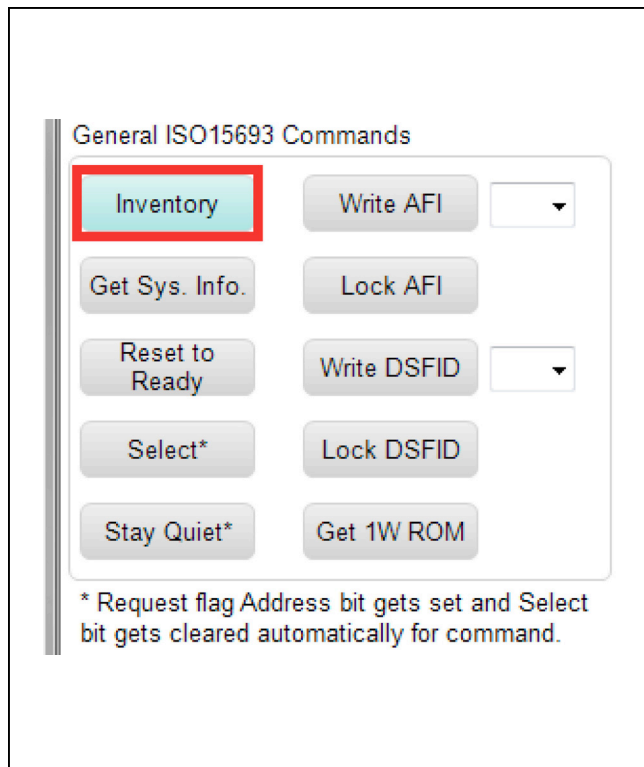

Figure 38. Inventory Button

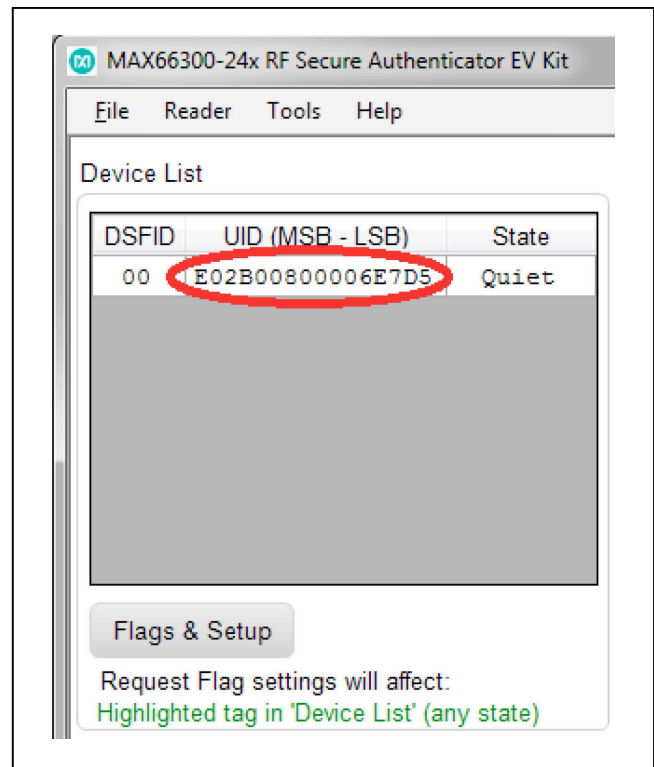

Figure 39. Device List

ABRIDGED DATA SHEET

MAX66300-24x Evaluation Kit

Evaluates: MAX66300, MAX66242

- 3) Click on the **Reset to Ready** button in the **General ISO 15693 Commands** group box (Figure 40).
Note: This sets the State from **Quiet** to **Ready** in the **Device List**.
- 4) Click on the **Peripheral Transaction** tab (Figure 41)
- 5) First, set the **Bytes to Read** to-be '2'. Second, set the I²C address in the **Write Data** field to be '91h' (with read bit set). Third, click the **Execute** button. Fourth, verify the temperature returned from the I²C bus. In this example, the bytes '1800h' read corresponds to a temperature of 24.0°C from the DS75S (Figure 42)

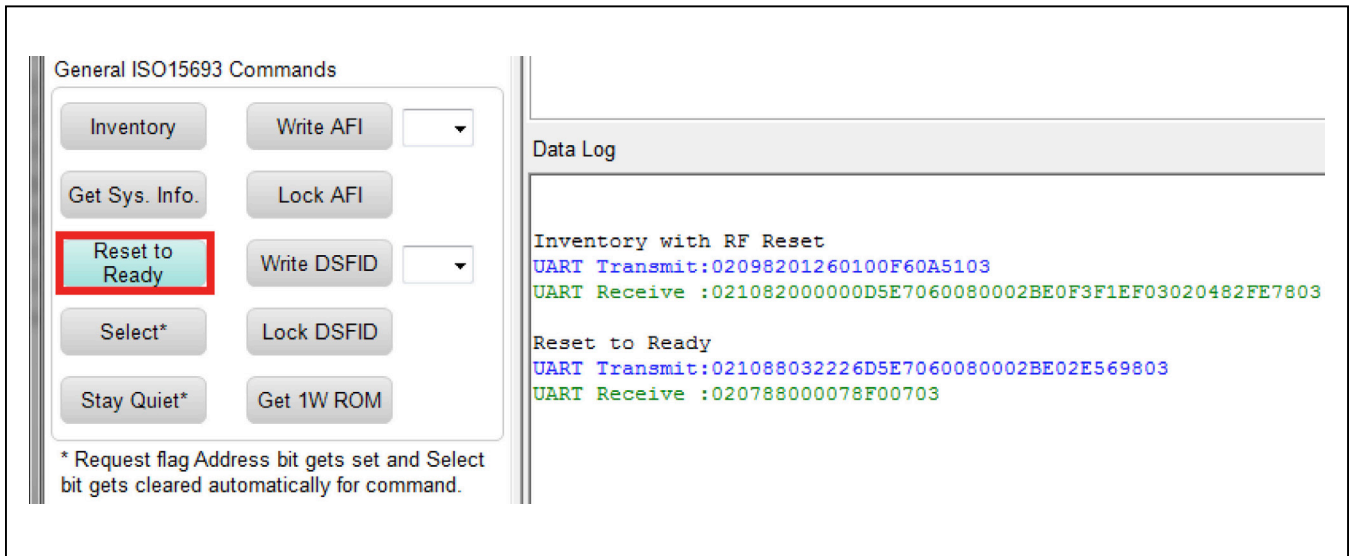

Figure 40. Ready to Reset Button

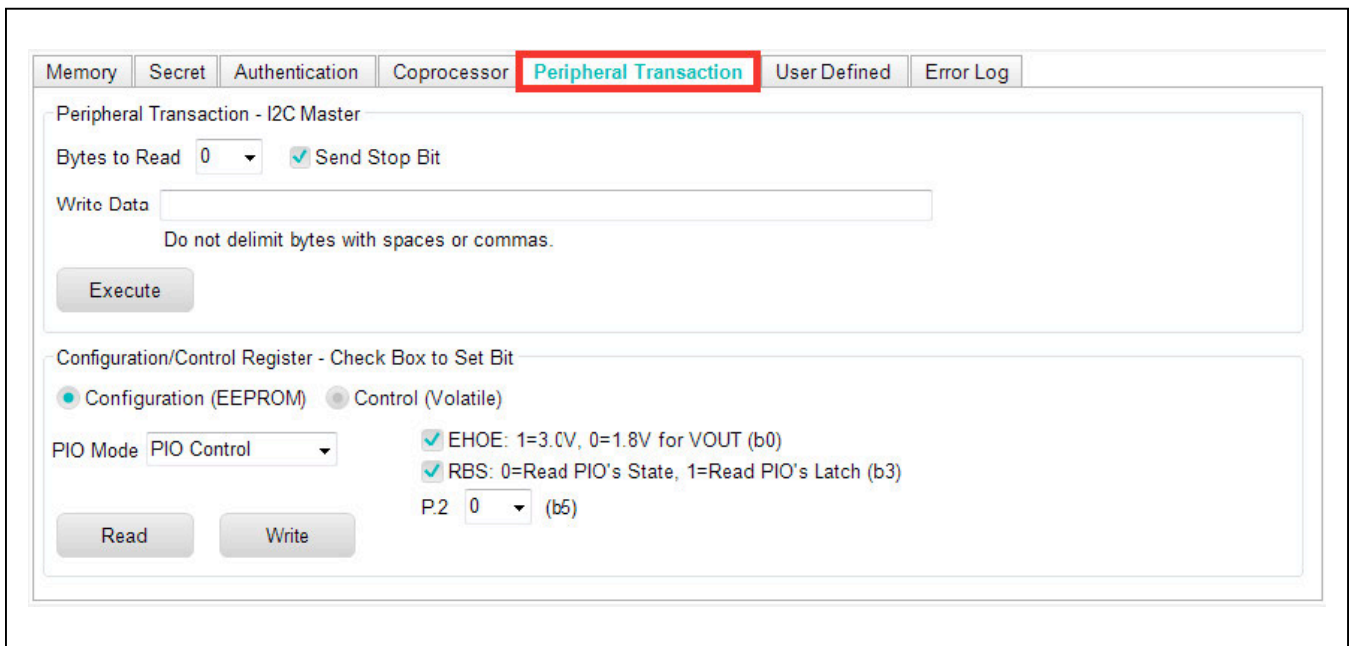

Figure 41. Peripheral Transaction Tab

ABRIDGED DATA SHEET

MAX66300-24x Evaluation Kit

Evaluates: MAX66300, MAX66242

The screenshot displays the 'Peripheral Transaction' tab in a software interface. It is divided into two main sections: 'Peripheral Transaction - I2C Master' and 'Configuration/Control Register - Check Box to Set Bit'.
In the 'Peripheral Transaction - I2C Master' section, the 'Bytes to Read' is set to 2, and the 'Send Stop Bit' checkbox is checked. The 'Write Data' field contains '91'. Below this, there is an 'Execute' button.
The 'Configuration/Control Register' section includes radio buttons for 'Configuration (EEPROM)' and 'Control (Volatile)'. It also features a 'PIO Mode' dropdown set to 'PIO Control', and checkboxes for 'EHOE: 1=3.0V, 0=1.8V for VOUT (b0)' and 'RBS: 0=Read PIO's State, 1=Read PIO's Latch (b3)'. A 'P.2' dropdown is set to '0 (b5)'. 'Read' and 'Write' buttons are present at the bottom of this section.
The 'Data Log' section at the bottom shows a log of transactions. The log entry for 'UART Receive' is ':020A9000018000089BFB403', with the value '1800' highlighted in a red box.

Memory Secret Authentication Coprocessor **Peripheral Transaction** User Defined Error Log

Peripheral Transaction - I2C Master

Bytes to Read 2 ¹ Send Stop Bit

Write Data 91 ²

³ Do not delimit bytes with spaces or commas.

Execute

Configuration/Control Register - Check Box to Set Bit

Configuration (EEPROM) Control (Volatile)

PIO Mode PIO Control EHOE: 1=3.0V, 0=1.8V for VOUT (b0)

RBS: 0=Read PIO's State, 1=Read PIO's Latch (b3)

P.2 0 (b5)

Read Write

Data Log

```
Peripheral Transaction
UART Transmit:021790064C1D20A22BD5E7060080002BE0100191028E525803
UART Receive :020A9000018000089BFB403
```

⁴

Figure 42. Temperature Read Button

ABRIDGED DATA SHEET

MAX66300-24x Evaluation Kit

Evaluates: MAX66300, MAX66242

User Defined

This section demonstrates how to form a transmit packet with the MAX66300 EV kit and receive the response from the MAX66242 tag. Start out were the **Peripheral Transaction** section left off and perform the following steps:

- 1) Click on the **User Defined** tab (Figure 43).
- 2) To create the transmit packet from the previous **Peripheral Transaction** and send:
 - a) First, enter bytes in the **MAX66300 COMMAND BYTES** field for a general write command (90h), the command parameter for command ID (06h), delay time LSB (4Ch), and delay time for MSB (1D). For more details, refer to the General Write section in the MAX66300 data sheet (Figure 44).
 - b) Second, enter the **RF** field byte (20h). The sets the request flag values.
 - c) Enter the **ISO15693 Payload** (A22BD5E7060080002BE010019102h) to deliver the request to the MAX66242 tag (Figure 44).
 - d) Send the formed packet by clicking on **Execute** button (Figure 44). The STX, ICK, CRC, CHK, and ETX append automatically.
 - e) Verify temperature in the response is approximately what was seen the **Peripheral Transaction**. In this case, the bytes '1780h' correspond to 23.5°C.

Memory Secret Authentication Coprocessor Peripheral Transaction **User Defined** Error Log

ISO15693 Packet

STX	ICK	MAX66300 COMMAND BYTES	RF	ISO15693 Payload	CRC	CHK	ETX
02	17	90064C1D	20	A22BD5E7060080002BE010019102h	8E52	58	03

The empty grey boxes will automatically populate when command is executed.

STX = Start of Message
ICK = Index of Checksum
RF = Request Flags
CRC = ISO15693 Payload CRC
CHK = Checksum
ETX = End of Message

Execute

Figure 43. User Defined Tab

ABRIDGED DATA SHEET

MAX66300-24x Evaluation Kit

Evaluates: MAX66300, MAX66242

The screenshot displays the 'User Defined' configuration window for sending an ISO15693 packet. The fields are as follows:

STX	ICK	MAX66300 COMMAND BYTES	RF	ISO15693 Payload	CRC	CHK	ETX
02	17	90064C1D	20	A22BD5E7060080002BE010C	8E52	58	03

The empty grey boxes will automatically populate when command is executed.

Legend:

- STX = Start of Message
- ICK = Index of Checksum
- RF = Request Flags
- CRC = ISO15693 Payload CRC
- CHK = Checksum
- ETX = End of Message

The 'Execute' button is located below the legend.

Data Log:

```
Peripheral Transaction
UART Transmit:021790064C1D20A22BD5E7060080002BE0100191028E525803
UART Receive :020A90000018000089BFB403

User Defined Command
UART Transmit:021790064C1D20A22BD5E7060080002BE0100191028E525803
UART Receive :020A900000178008279F603
```

Figure 44. Send Transmit Packet

ABRIDGED DATA SHEET

MAX66300-24x Evaluation Kit

Evaluates: MAX66300, MAX66242

Detailed Description of Hardware

The MAX66300-24x EV system block diagram in [Figure 45](#) is a functional representation. Starting from the left side, the prolific device (i.e., PL-2303HXD) provides a virtual COM port to link the PC to the MAXQ610 and is fully compatible with USB 2.0 specification. The MAXQ610 is preloaded with firmware that either passes the UART protocol along or converts the UART protocol to SPI with a SCLK at 2.667MHz. The MAX66300 provides the RFID reader processing per ISO 15693 and the secure coprocessor functionality is based on FIPS 180-4 standard. The AFE in the MAX66300 drives a PCB antenna in a 100mW configuration. Lastly, the MAX66242 is the tag in the

system-supporting authentication (i.e., clone prevention), harvesting power to illuminate an LED and an I²C link to a DS75S peripheral.

Jumpers and Switches

Both the MAX66300 EV kit and the MAX66242 tag have jumpers that allow configuration options or for external linking during evaluation. Additionally, the MAX66300 contains switches for more configuration options.

[Table 1](#) and [Figure 46](#) describe the MAX66300 EV kit and the function of the jumpers. Default settings from [Table 1](#), in summary, support UART or SPI linking, USB power, and 3.3V operation.

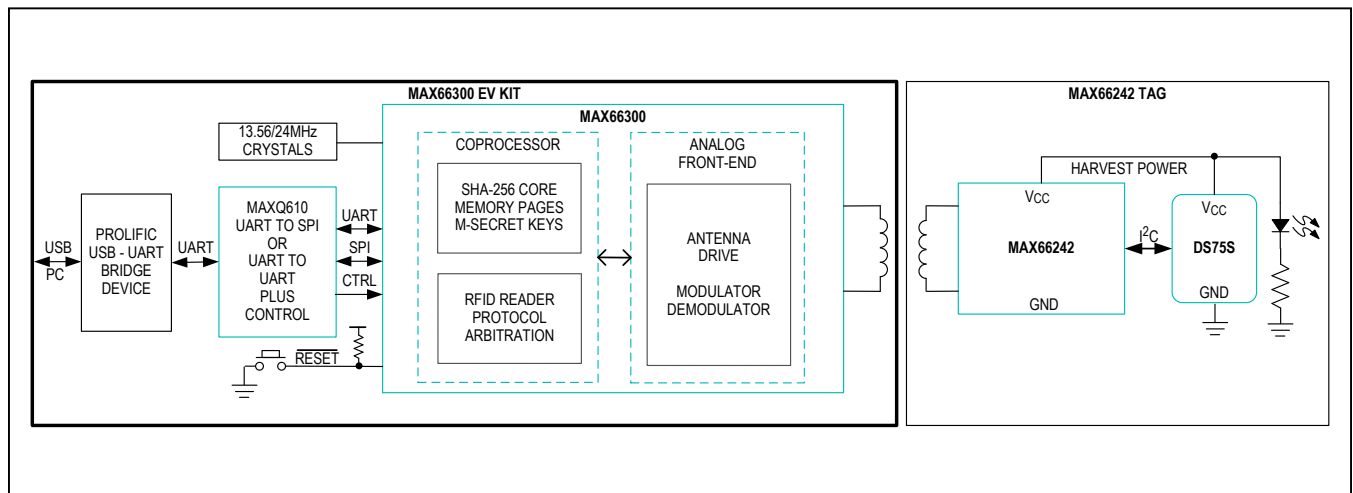

Figure 45. MAX66300-24x EV System Block Diagram

ABRIDGED DATA SHEET

MAX66300-24x Evaluation Kit

Evaluates: MAX66300, MAX66242

Table 1. MAX66300 EV Kit Jumpers

REFERENCE DESIGNATOR	MAX66300 DESCRIPTION	DEFAULT SETTING	FUNCTION
JB1	AGD—Reference Voltage Output	Close (1-2)	Pullup enabled for 3.3V operation
JB2	TXD—UART Transmit RXD—UART Receive MISO—Master In-Slave Out MOSI—Master Out-Slave In SCLK—Serial Clock SSEL—Slave Select IRQ—Interrupt Out SLEEP—Sleep Mode In BUSY—Busy Out PORTSLCT—Port Select In TP (EN)—Test Pin GND—Ground Probe	Close (1-2), Close (3-4), Close (5-6), Close (7-8), Close (9-10), Close (11-12), Open (13-14), Close (15-16), Close (17-18), Close (19-20), Close (21-22), Open (23-24)	Link to MAXQ610 UART receive Link to MAXQ610 UART transmit Link to MAXQ610 SPI MISO Link to MAXQ610 SPI MOSI Link to MAXQ610 SPI SCLK Link to MAXQ610 SPI SSEL Link to MAXQ610 P1.6 PIO (not used) Link to MAXQ610 P1.5 Out for sleep control Link to MAXQ610 P1.4 In detect SPI busy Link to MAXQ610 P3.5 and switch 5 (SW3) Link to MAXQ610 P1.7 out high and jumper (J9) Ground connect for probing
JB3	VCC5—5V Supply Rail	Close (1-2)	Link to 5V USB power from the PC
J3	3.3V/5V VDD_AFE_DIG Select	Close (1-2)	Select AFE digital voltage to be 3.3V
J4	3.3V/5V VDDA1 Select	Close (1-2)	Select AFE antenna driver 1 to be 3.3V
J5	3.3V/5V VDDA2 Select	Close (1-2)	Select AFE antenna driver 2 to be 3.3V
J9	TP Select	Close (2-3)	Pulled low since driven high from MAXQ610

ABRIDGED DATA SHEET

MAX66300-24x Evaluation Kit

Evaluates: MAX66300, MAX66242

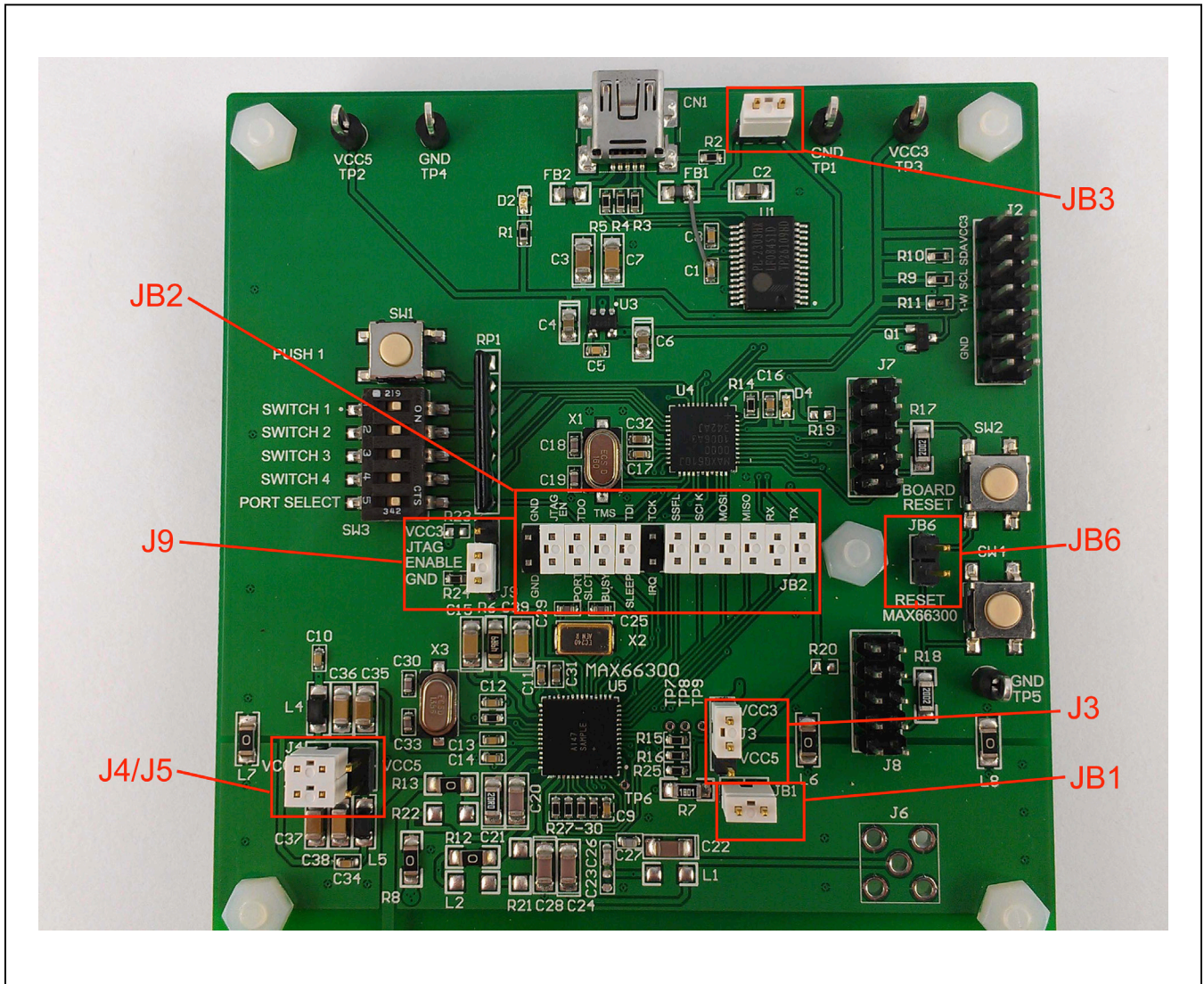

Figure 46. MAX66300 EV Kit Jumpers

ABRIDGED DATA SHEET

MAX66300-24x Evaluation Kit

Evaluates: MAX66300, MAX66242

Table 2 and Figure 47 describe the switch settings for MAX66300 EV kit. SW1 is reserved for future use. SW3 switch positions 1 to 4 are reserved for future use and position 5 selects between UART or SPI port selection. SW4 resets the MAX66300 during evaluation if needed.

Table 3 and Figure 48 describe the jumper settings for the MAX66242 tag. Default settings support I2C linking, access to PIO pin and energy harvesting.

Table 2. MAX66300 EV Kit Switches

REFERENCE DESIGNATOR	POSITION	ON POSITION (SIGNAL IS GROUNDED)	OFF POSITION (SIGNAL IS PULLED UP)
SW1	PUSH 1	Not used	Not used
SW3	Switch 1	Not used	Not used
SW3	Switch 2	Not used	Not used
SW3	Switch 3	Not used	Not used
SW3	Switch 4	Not used	Not used
SW3	Port select	UART port selection	SPI port selection
SW4	Reset MAX66300	Push—MAX66300 in reset	MAX66300 normal

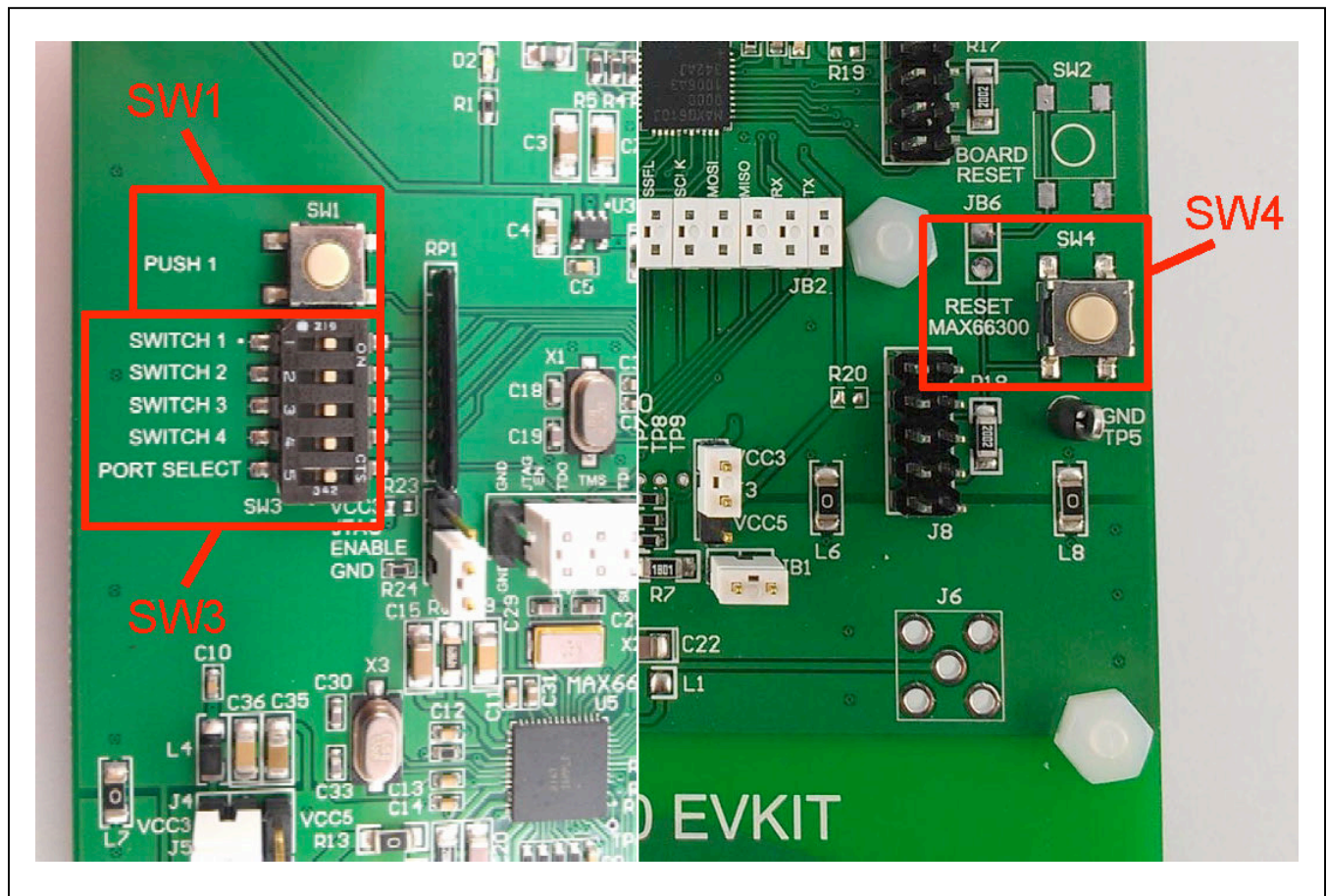

Figure 47. MAX66300 EV Kit Switch

ABRIDGED DATA SHEET

MAX66300-24x Evaluation Kit

Evaluates: MAX66300, MAX66242

Table 3. JB1 MAX66242 Tag Jumpers

REFERENCE DESIGNATOR	MAX66242 DESCRIPTION	DEFAULT SETTING	FUNCTION
JB1	V _{CC} /GND—Power and ground SDA—I ² C serial data in/out SCL—I ² C serial clock input PIO—Multipurpose open drain V _{OUT} —Energy harvesting pin GND—Ground link V _{OUT} —Energy harvesting pin	Open (1-2), Close (3-4), Close (5-6), Open (7-8), Close (9-10), Close (11-12), Close (13-14)	Used for probing as pin 1 is V _{CC} and pin 2 is GND Link SDA to DS75S Link SCL to DS75S Pin 7 is PIO and pin 8 is not used Link V _{OUT} to DS75S's V _{CC} Link GND to DS75S Link V _{OUT} to the LED through a 3.6kΩ resistor

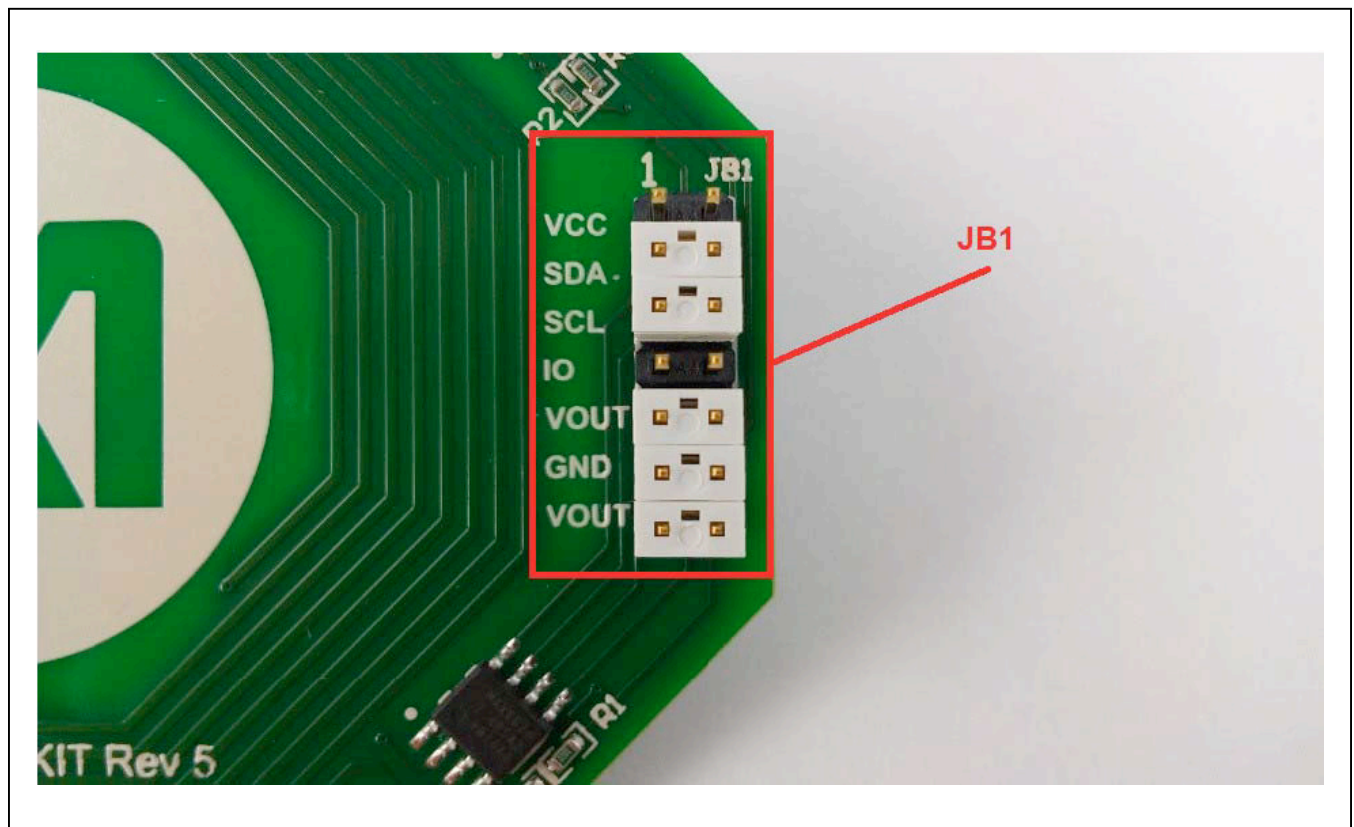

Figure 48. MAX66242 EV Kit Jumpers

ABRIDGED DATA SHEET

MAX66300-24x Evaluation Kit

Evaluates: MAX66300, MAX66242

Ordering Information

PART	TYPE
MAX66300-24xEVKIT#	EV System

#Denotes RoHS compliant.

ABRIDGED DATA SHEET

MAX66300-24x Evaluation Kit

Evaluates: MAX66300, MAX66242

MAX66300-24x EV Kit Bill of Materials

COMMENT	DESCRIPTION	DESIGNATOR	FOOTPRINT	LIBREF	QUANTITY	PART NUMBER
0.1uF	0.1uF/0603/16V	C1, C8, C9, C10, C11, C	CAP0603-3D	CAP	11	CL10B104KO8NUNC
10uF/0805/10V	10uF/0805/10V	C2	CAP0805-3D	CAP	1	CL21A106KOQNNNE
10uF/1206		C3	CAP1206-3D	CAPACITOR	1	CL21A106KOQNNNE
2.2uF/0805/16V	2.2uF/0805/16V	C4, C6	CAP0805-3D	CAP	2	CL21B225KPFNNNE
10nF	10nF/0603/25V	C5	CAP0603-3D	CAP	1	CL10B103KB8NCNC
0.1uF		C7	CAP1206-3D	CAP	1	CL31B104KBCNNNC
1uF		C15	CAP1206-3D	CAP	1	CL31B105KAHNNNE
22pF		C18, C19, C25, C29, C3	CAP0603-3D	CAP	6	CL10C220JB8NNNC
op1 680pF op2 100pF		C20	CAP1206-3D	CAP	1	CGJ5C4COG2H101J060AA
op1 680pF op2 20ohm		C21	CAP1206-3D	CAP	1	ERJ-8ENF20R0V
33pF		C22	CAP1206-3D	CAP	1	CL31C330JBCNNNC
820pF		C23	CAP0603-3D	CAP	1	CL10C821JB8NNNC
560pF		C24	CAP1206-3D	CAP	1	CL31C561JBCNNNC
op1-1nF op2-15pF		C26	CAP0603-3D	CAP	1	CGJ3E2C0G1H150J080AA
op1-680pF op2-68pF		C27	CAP0603-3D	CAP	1	CGJ3E2C0G1H680J080AA
820pF		C28	CAP1206-3D	CAP	1	CL31C821JBCNNNC
1uF		C31, C32	CAP0603-3D	CAP	2	CL10B105KP8NNNC
3.3uF		C35, C37	CAP1206-3D	CAP	2	CL31B335KOHNNNE
10nF		C36, C38, C39	CAP1206-3D	CAP	3	CL31B103KBCNNNC
USB MINI	SMT USB MINI Connector	CN1	USBMINI-3D	USB-MINI	1	KMBX-SMT-5S-S-30TR
LED GREEN		D2	0603LED-3DGREEN	LED	1	598-8081-107F
BLUE		D4	0603LED-3DBLUE	LED	1	LTST-C191TBKT
BLM21PG221SN1D	Ferrite Chip	FB1, FB2	0805-3D	FUSE1	2	BLM21PG221SN1D
TO AI27 BOARD		J2	DIH7X2-3D	JUMPBLOCK 7	1	PREC007DAAN-RC
JUMPER	2 WAY SELECTION JUMPER	J3, J4, J5	SIP3-3DSHORT	JUMPER2WAY-2	3	9-146276-0-03
COAX	COAX	J6	SMA1-3D	COAX2	1	CON SMA001
JTAG CONNECTOR #1	2 x 10 dual row 0.100mil male conn	J7	DIH5X2-3D	JUMPBLOCK 5	1	M20-9760546
JTAG CONNECTOR #2	2 x 10 dual row 0.100mil male conn	J8	DIH5X2-3D	JUMPBLOCK 5	1	M20-9760546
2 WAY JUMPER	2 WAY SELECTION JUMPER	J9	SIP3-3DSHORT	JUMPER2WAY-2	1	9-146276-0-03
SHUNT		JB1, JB3, JB6	SIP2-3D	JUMPBLOCK 1	3	9-146276-0-02
HEADER		JB2	DIH12X2-3D	JUMPBLOCK 12	1	952-1848-ND
op1-270nH op2-X		L1	1206-3D	INDUCTOR	1	
op1-180nH op2-X		L2	1206-3D	INDUCTOR	1	
ANTENNA		L3	AXIAL0.6	INDUCTOR	1	N/A
10uH		L4, L5	1206INDUCTOR-3D	INDUCTOR	2	LQH31MN100J03L
INDUCTOR		L6, L7, L8	1206INDUCTOR-3D	INDUCTOR	3	RMCF1206ZT0R00
BSS84	PCHAN FET	Q1	16001-3D	PCHAN FET	1	BSS84
3.3K	1.5k/0603	R1, R9, R10	0603-3D	RESISTOR	3	ERJ-3EKF3301V
10	10R/0603	R2	0603-3D	RESISTOR	1	ERJ-3EKF10R0V
27	27R/0603	R3, R4	0603-3D	RESISTOR	2	ERJ-3EKF27R0V
1.5k	1.5k/0603	R5, R14	0603-3D	RESISTOR	2	ERJ-3EKF1501V
50 Ohm		R6	1206-3D	RESISTOR	1	RNCP1206FTD49R9
op1-X op2-0		R8, R12, R13	1206-3D	RESISTOR	3	RMCF1206ZT0R00
750		R11	0603-3D	RESISTOR	1	ERJ-3EKF7500V
10K		R15, R16, R25	0603-3D	RESISTOR	3	ERJ-3EKF1002V
20K		R17, R18	1206-3D	RESISTOR	2	ERJ-8ENF2002V
DNP	0R/0603	R19, R20, R23	0603-3D	RESISTOR	3	

ABRIDGED DATA SHEET

MAX66300-24x Evaluation Kit

Evaluates: MAX66300, MAX66242

MAX66300-24x EV Kit Bill of Materials

COMMENT	DESCRIPTION	DESIGNATOR	FOOTPRINT	LIBREF	QUANTITY	PART NUMBER
op1-0 op2-X, DNP		R21, R22	1206-3D	RESISTOR	2	
20k		R24	0603-3D	RESISTOR	1	ERJ-3EKF2002V
22		R26, R27, R28, R29, R30	0603-3D	RESISTOR	5	ERJ-3EKF22R0V
10K		RP1	SIP7	RESISTOR SIP7	1	CSC07A0110K0GEK
PUSH		SW1	RESET2-3D	SW-PB	1	B3S-1000
RESET		SW2, SW4	RESET2-3D	SW-PB	2	B3S-1000
DIPSWITCH5		SW3	DIPSWITCH5 SMT	DIPSWITCH5	1	219-5LPST
GND	Test Point	TP1, TP4, TP5	TP-3D	TP	3	5011
VCC5	Test Point	TP2	TP-3D	TP	1	5011
VCC3.3	Test Point	TP3	TP-3D	TP	1	5011
PL-2303HXD	USB to Serial Bridge	U1	TSSOP28-3D	PL-2303HXD	1	PL-2303HXD Rev D
MAX8887EZK33+T	LDO 300mA Linear Regulator 1.5, 1.8, 2.8V	U3	SOT23-5-3D	MAX8887	1	MAX8887EZK33+T
MAXQ610	Multi I/O Processor w/ IR support	U4	TQFN44 7MM	MAXQ610 TQFN44	1	MAXQ610J-0000+
AI47 R2		U5	TQFN56 8MM	AI47 R2	1	MAX66300
16MHz		X1	CRYSTAL-CSM-3X-3D	CRYSTAL	1	ECS-160-20-3X-TR
24.00MHz		X2	CRYSTAL-ECX-64	CRYSTAL	1	ECS-240-20-23A-EN-TR
13.56MHz		X3	CRYSTAL-CSM-3X-3D	CRYSTAL	1	ECS-135.6-20-3X-TR

ABRIDGED DATA SHEET

MAX66300-24x Evaluation Kit

Evaluates: MAX66300, MAX66242

MAX66300-24x EV Kit Schematics

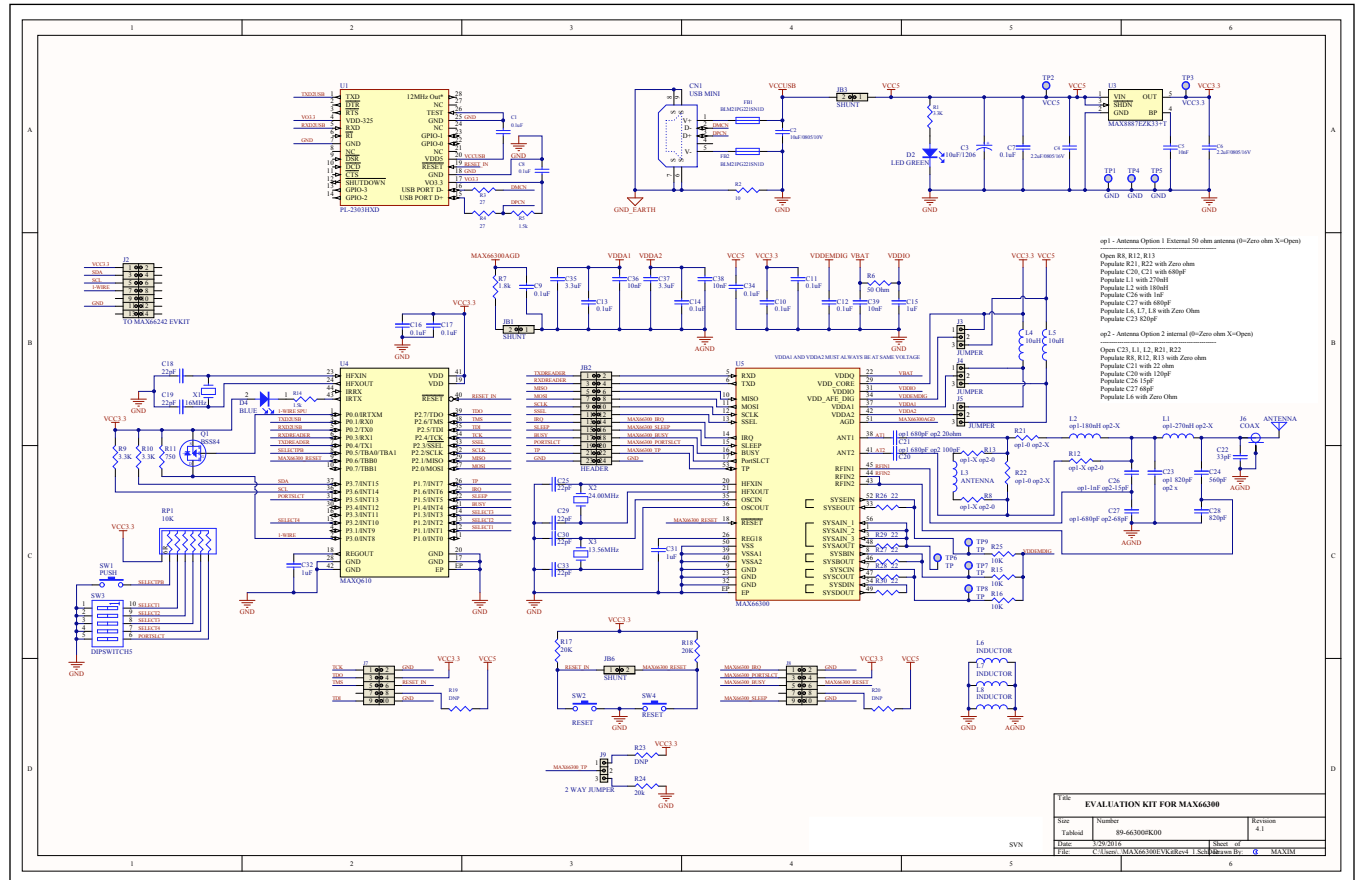

ABRIDGED DATA SHEET

MAX66300-24x Evaluation Kit

Evaluates: MAX66300, MAX66242

MAX66300-24x EV Kit PCB Layout

ASSEMBLY INFORMATION
MAX66300 REV 4.1

MAX66300 EVKit			
Part Number: 89-66300#K00		Rev 4.1	
Property of maxim integrated			
Drill and Mechanical Layer			
MAR 27 2016		Units in mils	
SIZE	QTY	SYM	PLATED TOLERANCE
10	118	YES	+/- 0.003
17	6	YES	+/- 0.003
36	2	NO	+/- 0.003
39	83	YES	+/- 0.003
59	5	YES	+/- 0.003
62	5	YES	+/- 0.003
150	7	NO	+/- 0.003

Notes:

1. Material: RoHS Compliant FR-408 or similar laminate material
2. Board Dimensions: 3.50 x 7.00 Inches
3. Board Thickness: 0.062 mils +/- 20%
4. Layers: 2
5. Minimum Trace Width / Trace Spacing: 9mil / 7mil
6. Copper Thickness: 1oz on all layers
7. Surface mount pads: 223
8. Through holes: Quantity = 226, minimum size = 0.010 mil
9. Soldermask: Green
10. Legend: White on Top
11. Plating: Best plating option for lead free
12. Finish: Best finish option for lead free
13. Vendor Logo & date code: Allowed on bottom side only
14. Testing Needed: Yes
15. Tolerances:
 - Plated-through holes +/- 0.003
 - Metal to Metal +/- 0.003
 - Legend to legend +/- no preference
 - Soldermask to Metal +/- 0.003

Layer Stack Up Detail for: MAX66300EVKitRev4.1.PcbDoc

Layer Name

PCB Core Material

ABRIDGED DATA SHEET

MAX66300-24x Evaluation Kit

Evaluates: MAX66300, MAX66242

MAX66300-24x EV Kit PCB Layout (continued)

MAX66300 EVKit				
Part Number: 89-66300#K00				
Property of maxim integrated			Rev	
Drill and Mechanical Layer			4.1	
MAR 27 2016			Units in mils	

SIZE	QTY	SYM	PLATED	TOLERANCE
10	118		YES	+/- 0.003
17	6		YES	+/- 0.003
36	2		NO	+/- 0.003
39	83		YES	+/- 0.003
59	5		YES	+/- 0.003
62	5		YES	+/- 0.003
150	7		NO	+/- 0.003

Notes:

1. Material: RoHS Compliant FR-408 or similar laminate material
2. Board Dimensions: 3.50 x 7.00 inches
3. Board Thickness: 0.062 mils +/- 20%
4. Layers: 2
5. Minimum Trace Width / Trace Spacing: 9mil / 7mil
6. Copper Thickness: 1oz on all layers
7. Surface mount pads: 223
8. Through holes: Quantity = 226, minimum size = 0.010 mil
9. Soldermask: Green
10. Legend: White on Top
11. Plating: Best plating option for lead free
12. Finish: Best finish option for lead free
13. Vendor Logo & date code: Allowed on bottom side only
14. Testing Needed: Yes
15. Tolerances:
 - Plated-through holes +/- 0.003
 - Metal to Metal +/- 0.003
 - Legend to legend +/- no preference
 - Soldermask to Metal +/- 0.003

Layer Stack Up Detail for: MAX66300EVKitRev4_1.PcbDoc

Layer Name
PCB Core Material
Bottom Layer

The diagram shows a rectangular PCB layout on a blue background. White traces represent the circuitry, connecting various components. There are several circular pads and through-holes. The board dimensions are 3.50 inches by 7.00 inches, as indicated by the green dimension lines. The layout includes a central component area with a complex network of traces, and a larger area at the bottom with fewer traces and a few larger pads.

ABRIDGED DATA SHEET

MAX66300-24x Evaluation Kit

Evaluates: MAX66300, MAX66242

MAX66300-24x EV Kit PCB Layout (continued)

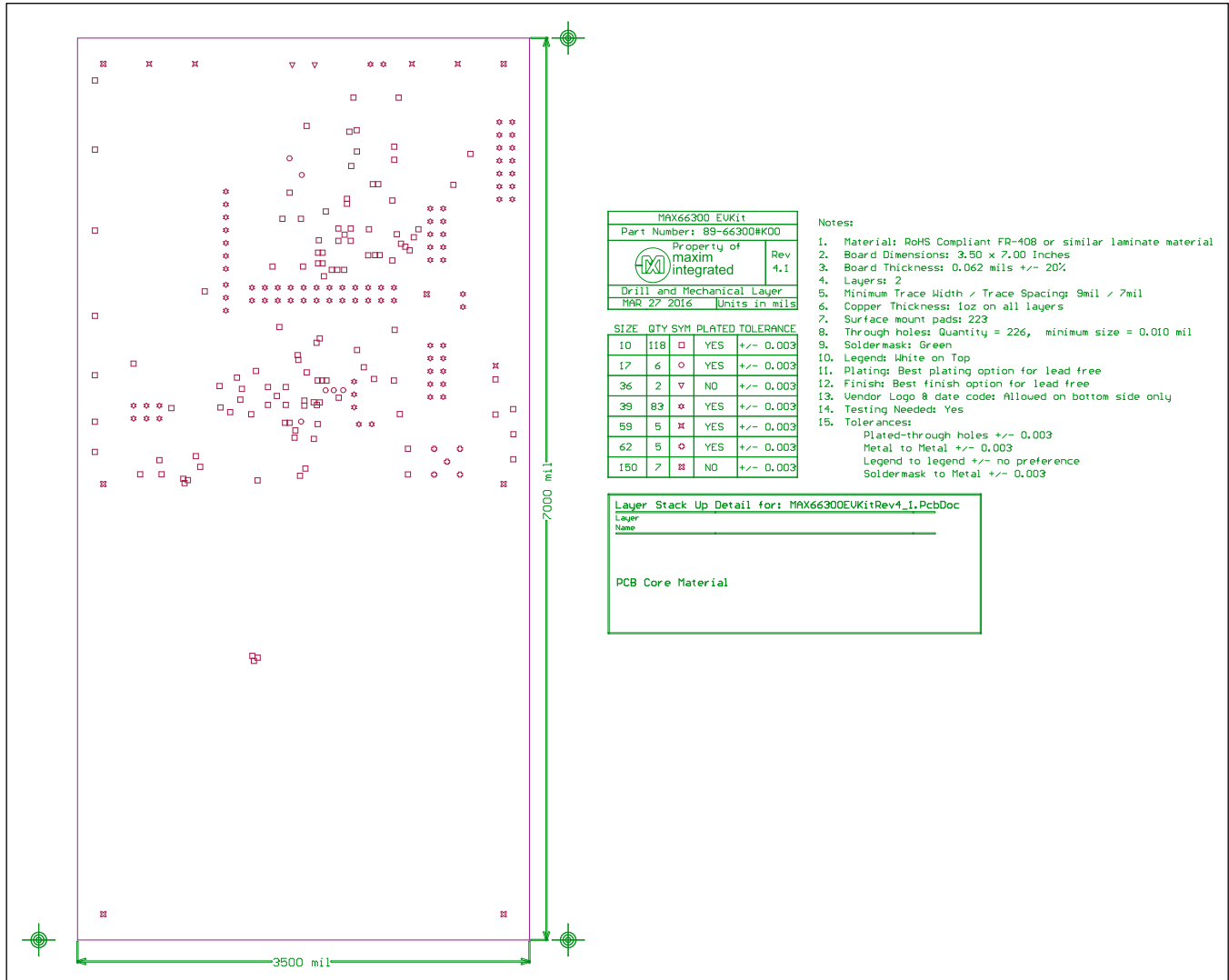

ABRIDGED DATA SHEET

MAX66300-24x Evaluation Kit

Evaluates: MAX66300, MAX66242

MAX66242 EV Kit Bill of Materials

DESCRIPTION	DESIGNATOR	QUANTITY	PART NUMBER
PCB#, Assembled for MAX66242#K00 Kit		1	90-66242#K00
ISO 15693, I2C, SHA-256, and 4Kb User EEPROM	U1	1	MAX66242ESA+
2-WIRE DIG THER 0.5C SOIC-8	U2	1	DS75S+
CAP,25V,10% 0.1uF,X7R,CER,0603	C1	1	C1608X7R1E104K
LED+,GREEN CLEAR,3.2V,20MA,0603	D1	1	598-8081-107F
RES+,3.2K OHM,0.1%,0603	R1, R2, R3	3	RT0603BRD073K2L
Header, 7X2	JB1	1	10897142
SHUNT+,LP W/HANDLE 2 POS 30AU	Jumper	5	4-881545-2

ABRIDGED DATA SHEET

MAX66300-24x Evaluation Kit

Evaluates: MAX66300, MAX66242

MAX66242 EV Kit Schematic

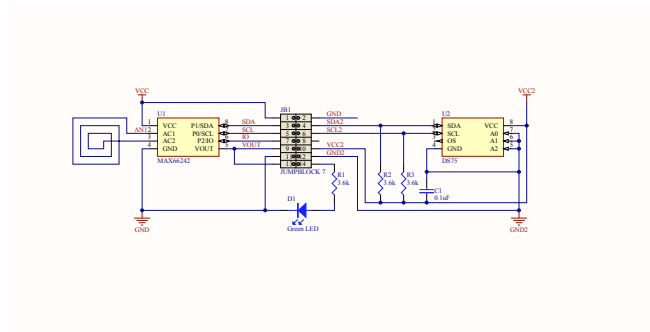

ABRIDGED DATA SHEET

MAX66300-24x Evaluation Kit

Evaluates: MAX66300, MAX66242

MAX66242 EV Kit PCB Layout

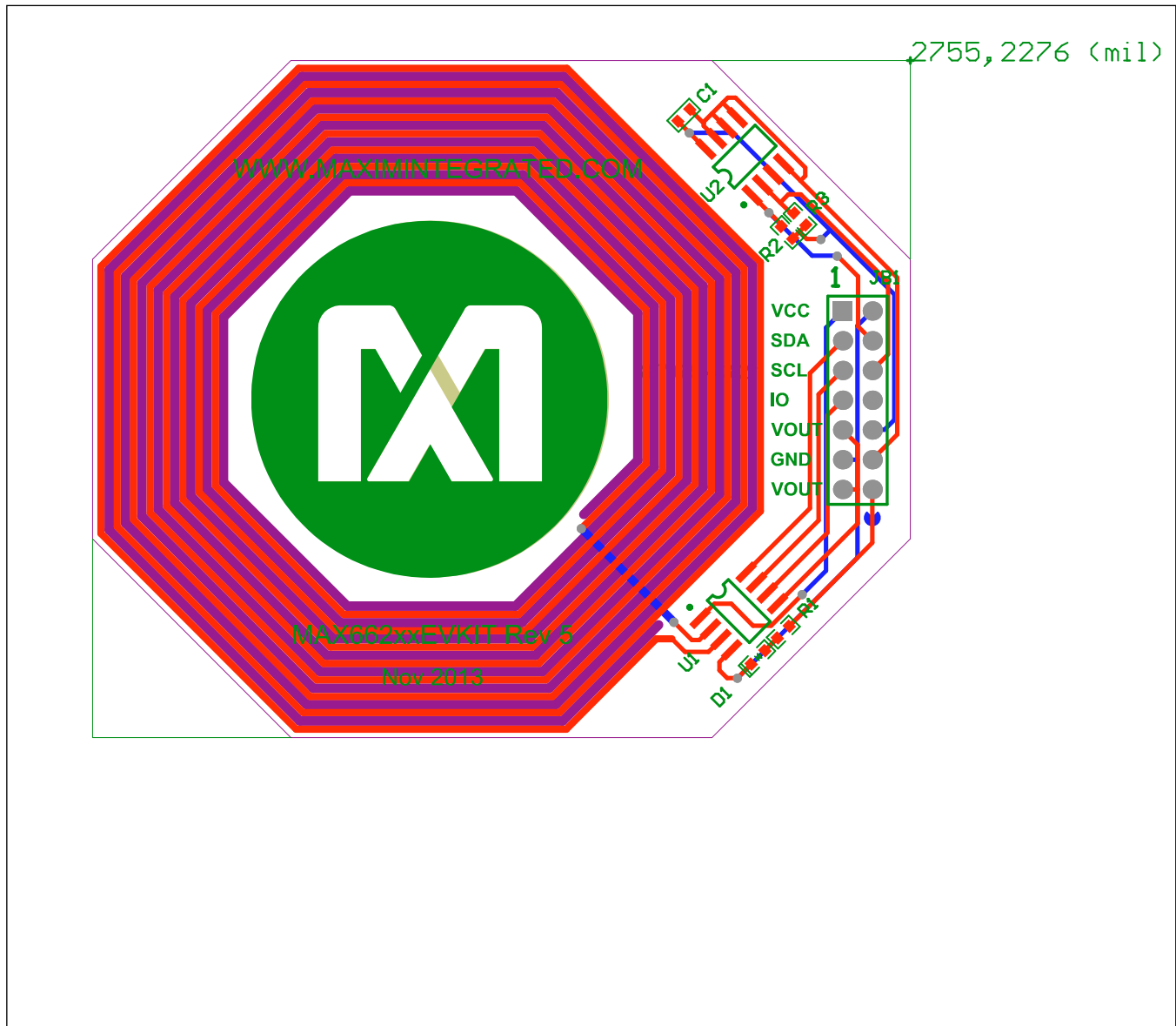

ABRIDGED DATA SHEET

MAX66300-24x Evaluation Kit

Evaluates: MAX66300, MAX66242

Revision History

REVISION NUMBER	REVISION DATE	DESCRIPTION	PAGES CHANGED
0	5/16	Initial release	—
1	8/16	Added bullet to <i>Features</i> section	1

For pricing, delivery, and ordering information, please contact Maxim Direct at 1-888-629-4642, or visit Maxim Integrated's website at www.maximintegrated.com.

Maxim Integrated cannot assume responsibility for use of any circuitry other than circuitry entirely embodied in a Maxim Integrated product. No circuit patent licenses are implied. Maxim Integrated reserves the right to change the circuitry and specifications without notice at any time.