

APPROVAL SHEET



WLAC29B Series
SMD Air Wound Coil Inductors

*Contents in this sheet are subject to change without prior notice.

Features

Acrylic jacket(WLAC29B) provides a flat top for pick and place

1. Acrylic cap provides a flat top for pick and place machine for high productive manufacture.
2. Excellent Q and SRF characteristics for RF application, especially in subGHz band.
3. Narrow tolerance available for precise design requirements.

Applications

1. Communication system front-end circuit: GSM/3G/LTE, Wi-Fi, GPS.
2. Cabel/Terrestrial/BS Tuner, Bluetooth, Wireless Audio, Remote control.
3. M2M: ZigBee, Proprietary wireless.
4. EMI solution in high frequency circuits.

Shape and Dimension

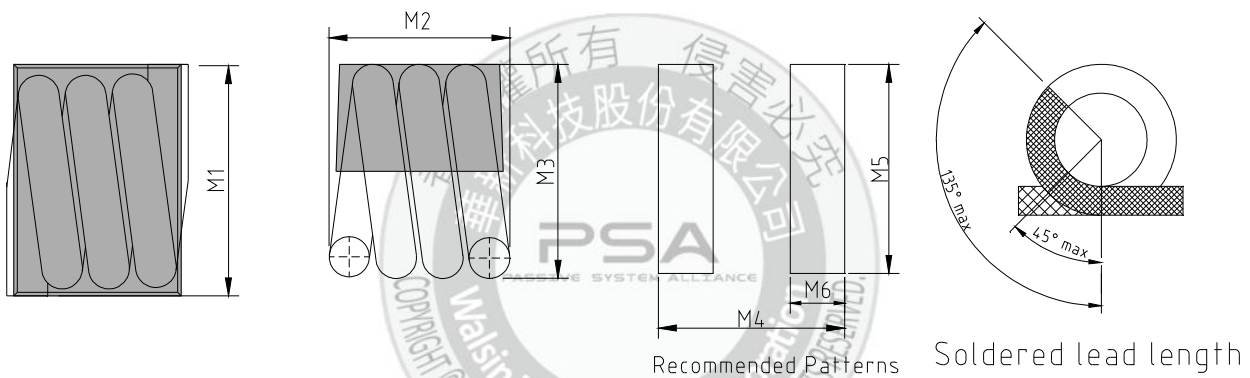

UNIT:mm

PART NO.	M1	M2	M3	M4	M5	M6
WLAC29BAZ0J3N7LB	5.71 MAX.	4.70 MAX.	5.33 MAX.	4.572	5.84	1.524
WLAC29BBZ0J6N6LB	5.46 MAX.	4.45 MAX.	4.95 MAX.	4.572	5.84	1.524
WLAC29BCZ0J12NLB	5.46 MAX.	4.96 MAX.	4.95 MAX.	5.207	5.84	1.524
WLAC29BDZ0J18NLB	5.59 MAX.	5.84 MAX.	4.95 MAX.	5.969	5.84	1.524

Ordering Information

WL	AC	29BA	Z0	J	3N7	L	B
Product Code	Series	Dimensions	Series Extension	Tolerance	Value	Packing Code	
WL: Inductor	Air wound coil inductor.	29BA=5.71*4.70*5.33mm 29BB=5.46*4.45*4.95mm 29BC=5.46*4.96*4.95mm 29BD=5.59*5.84*4.95mm	Z0:STD	J: ± 5%	3N7 = 3.7nH 6N6 = 6.6nH 12N = 12nH 18N = 17.5nH	P=13" Reeled (Embossed reel)	B:STD

Electrical Characteristics

● WLAC29B series

PART NO.	Inductance (nH) ±5%	Q TYP.	SRF TYP. (GHz)	DCR (mOHM) MAX.	Irms (A)
WLAC29BAZ0J3N7LB	3.7	100	17.5	2.0	7.0
WLAC29BBZ0J6N6LB	6.6	100	4.0	2.0	7.0
WLAC29BCZ0J12NLB	12.0	140	2.4	2.0	7.0
WLAC29BDZ0J18NLB	17.5	140	2.2	2.0	7.0

TOLERANCE : J=±5%,

※TEST INSTRUMENT

NOTE : 1. INDUCTANCE: AGILENT/HP16193 FIXTURE IN AGILENT/ 4291B

2. DCR:ZENTECH 502A

3. OPERATING TEMPERATURE RANGE : -40°C to +125°C.

4. SRF:AGILENT E5071C

5. INDUCTANCE AND Q MEASURED AT 150MHZ, 0.1Vrms.

ELECTRICAL CURVE

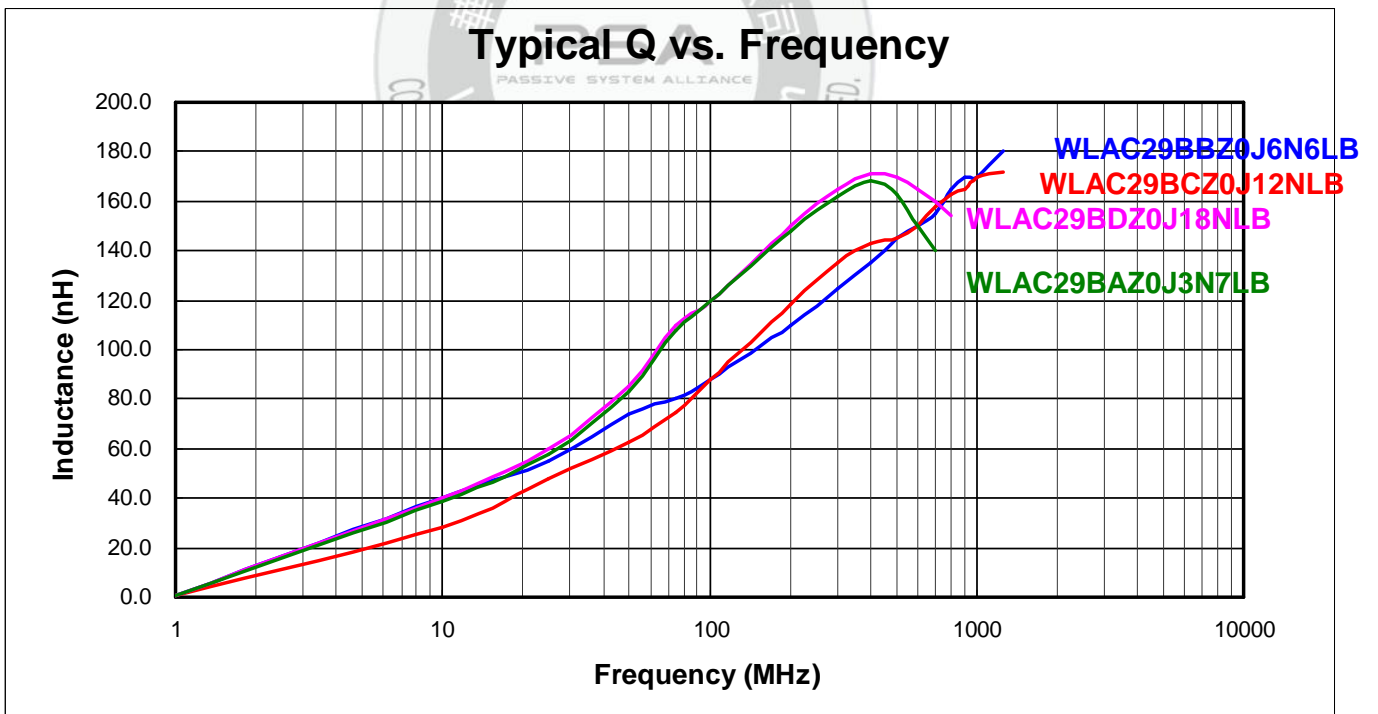
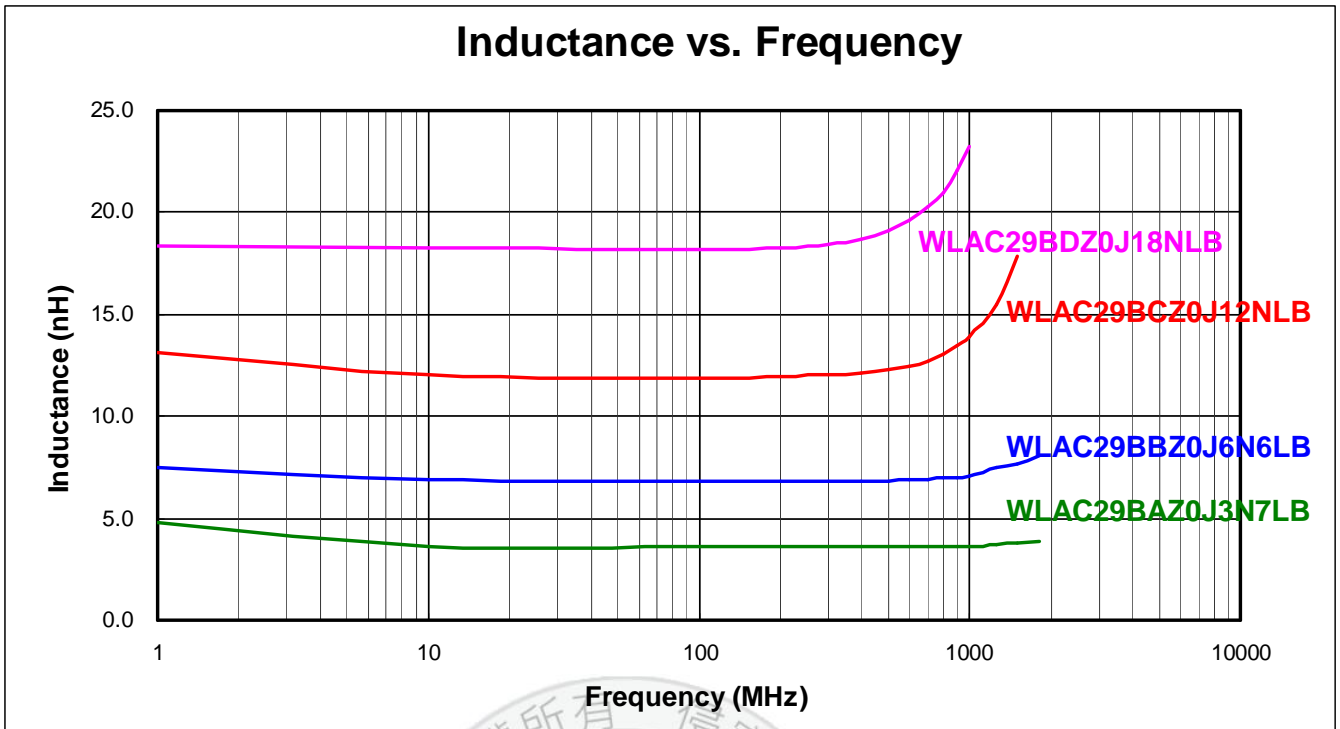

RELIABILITY PERFORMANCE

Reliability Experiment For Electrical

Test Item	Test Condition	Standard Source
Humidity Test	+40°C ± 2°C, humidity of 90% ± 5% (total 96 hours).	MIL-STD-202G Method 103B Test Condition B
High Temperature Test	1. Temperature: +125°C ± 2°C 2. Test time: 48 ± 2hrs	IEC 68-2 Test Condition B
Low Temperature Test	1. Temperature: -40°C ± 2°C 2. Test time: 48 ± 2hrs	IEC 68-2 Test Condition A
Thermal Shock	+125°C ± 5°C (30 minutes) ~ -40 ± 5°C (30 minutes), temperature switch time: 5 minutes (total 50 cycles).	MIL-STD-202G Method 107G Test Condition B-2
Life Test	+70°C ± 5°C (250Hours)	MIL-STD-202G Method 108A Test Condition B

Reliability Experiment For Physical

Test Item	Test Condition	Standard Source
Vibration Test	10-55-10HZ, amplitude: 1.5mm, direction: X, Y, Z axes, each axis 2 hours (total 6 hours).	MIL-STD-202G Method 201A
Solder Heat Resistance Test	IR/convection reflow: Peak Temp 260 ± 5°C for 30Sec in air, Through 2 Cycle. Temperature Ramp: +1~4°C/sec; Above 217°C, must keep 90 s - 120 s.	J-STD-020D Classification Reflow Profiles
Solder Ability Test	Soak in 245 °C solder pot of 3Sec, PAD must have 95% above coverage.	J-STD-003B

Typical RoHS Reflow Profile

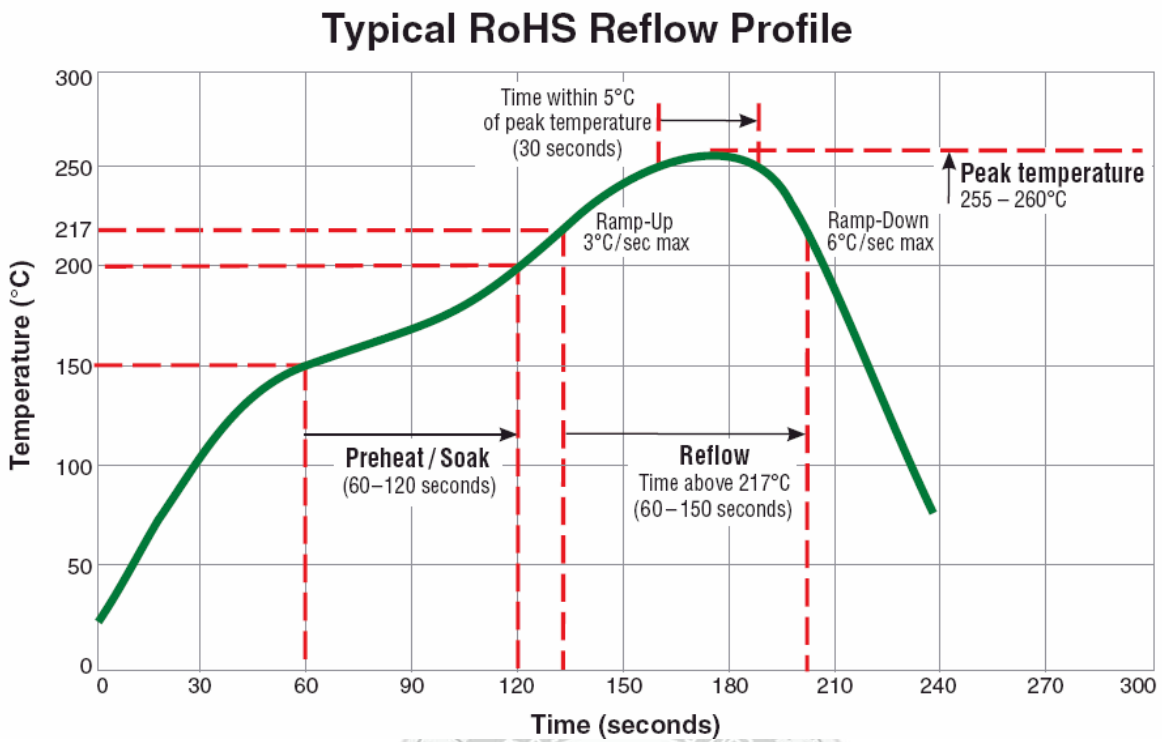

Packaging Specification (WLAC29Series)

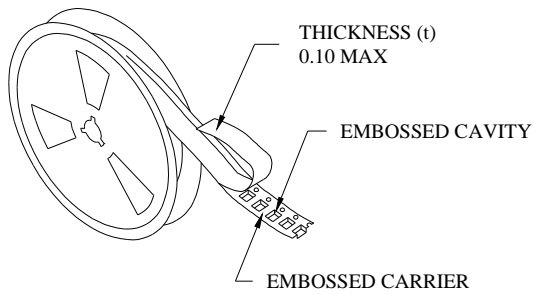

- THE FORCE FOR TEARING OFF COVER TAPE IS 10 TO 130 GRAMS IN THE ARROW DIRECTION.

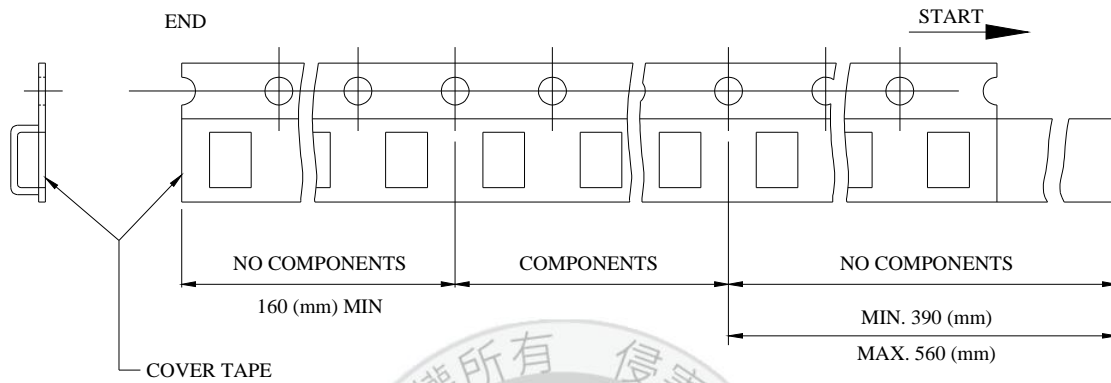
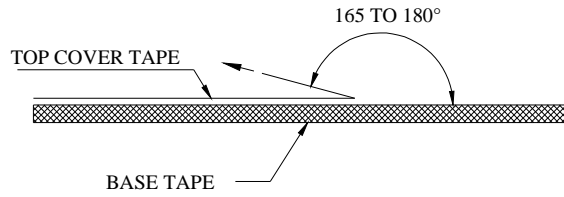

USER DIRECTION OF FEED

■ CARRIER TAPE REELS (mm)

MATERIAL: PLASTIC

■ DIMENSIONS OF CARRIER TAPE (mm)

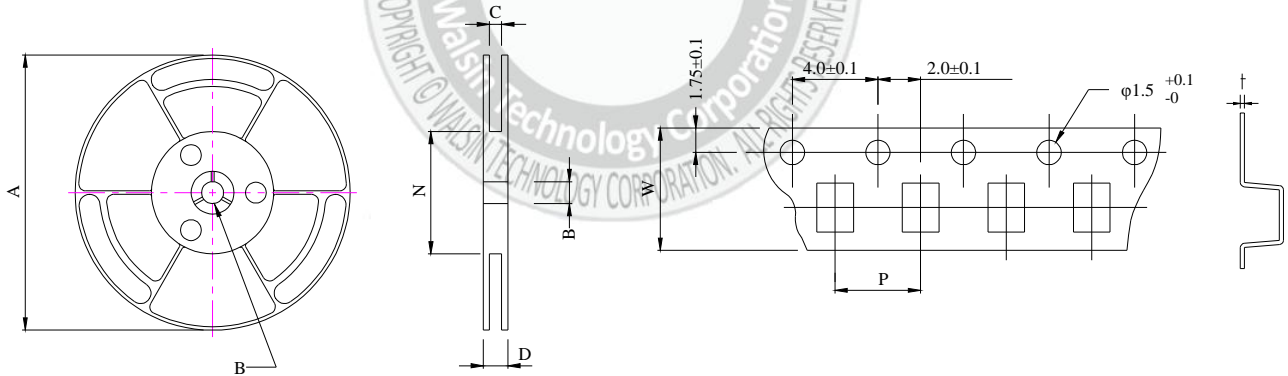

UNIT: mm

	A	B	C	D	N	P	W	t
DIM.	340	13.0	12.4	18.4	100	12.0	12.0	0.4
TOL.	MAX.	±0.5	+2.0-0	MAX	±0.5	±0.1	±0.3	±0.05

Quantity per reel : 1K pcs