

# TPS780xxEVM-301

This user's guide describes the characteristics, operation, and use of the TPS780xxEVM-301 evaluation module (EVM). This EVM demonstrates the Texas Instruments TPS780330220 ultra low-power, low dropout (LDO) regulator with pin-selectable, dual-output voltage levels. The TPS780330220 supplies up to 150 mA of output current at a pin programmable output voltage of 3.3 V ( $V_{SET} = \text{low}$ ) or 2.2 V ( $V_{SET} = \text{high}$ ) from a 2.2 V to 5.5 V input source. See the TPS780330220 data sheet ([SBVS083](#)) for definitive device specifications. This EVM user's guide includes setup instructions, schematic diagram, bill of materials (BOM), and PCB layout drawings.

## Contents

1	Introduction .....	1
2	Setup .....	2
3	Operation .....	2
4	Test Results .....	3
5	Board Layout, Schematic, and Bill of Materials .....	5
5.1	Board Layout .....	5
5.2	Schematic .....	8
5.3	Bill of Materials .....	9

## List of Figures

1	Startup from Enable .....	3
2	Load Transient, $V_I = 3.6\text{ V}$ , $V_{OUT} = 2.5\text{ V}$ , $I_{OUT} = 100\text{ mA}$ to $150\text{ mA}$ returning to $100\text{ mA}$ .....	3
3	Low to High Output Transient ( $V_{OUT} = 2.2\text{ V}$ to $3.3\text{ V}$ , $R_{LOAD} = 22\Omega$ ) .....	4
4	High to Low Output Transient ( $V_{OUT} = 3.3\text{ V}$ to $2.2\text{ V}$ , $R_{LOAD} = 22\Omega$ ) .....	4
5	Top Assembly Layer .....	5
6	Top Layer .....	6
7	Bottom Layer .....	7
8	TPS780xxEVM-301 Schematic .....	8

## List of Tables

1	TPS780xxEVM-301 Jumpers and Connections .....	2
2	TPS780xxEVM-301 Bill of Materials .....	9

## 1 Introduction

The TPS780xxEVM-301 evaluation module (EVM) assists designers in evaluating the operation and performance of the TPS780330220 low dropout regulator (LDO). This LDO provides up to 150 mA of output current at a pin-programmable output while maintaining ultra-low quiescent current ( $I_Q = 500\text{ nA}$ ). The board features the small  $2\text{ mm} \times 2\text{ mm}$  six-lead SON package (DRV) and the TSOT23-5 (DDC) package for small solution size.

### Related Documentation from Texas Instruments

*TPS780xx, Ultra Low-Power, 150mA Low Dropout Regulator, IQ 500nA with Pin-Selectable, Dual Output Voltage Levels*, data sheet ([SBVS083](#))

## 2 Setup

Table 1 describes the jumpers and connectors on the EVM, as well as how to properly connect, set up, and use the TPS780xxxEVM-301.

**Table 1. TPS780xxEVM-301 Jumpers and Connections**

Jumper	Connection Description	Connection Instructions
J1	U1 Input V (IN)	Connect the lead from the power terminal of the input source for the U1 circuit to this input
J2	U1 Input Ground (GND)	Connect the lead from the return terminal of the input source for the U1 circuit to this input
J3	U1 Output (OUT)	Connect the positive side of the load and/or output multimeter to this output
J4	U1 Output Ground	Connect the ground side of the load and/or output multimeter to this output.
J5	U2 Input V (IN)	Connect the lead from the power terminal of the input source for the U2 circuit to this input.
J6	U2 Input Ground	Connect the lead from the return terminal of the input source for the U2 circuit to this input.
J7	U2 Output	Connect the positive side of the load and/or output multimeter to this output.
J8	U2 Output Ground	Connect the ground side of the load and/or output multimeter to this output.
JP1	U1 EN	Enable input for the U1 device. Place a shunt across the H and EN pins of JP1 to enable U1. Place a shunt across the L and EN pins of JP1 to disable U1. A shunt must be installed on JP1 in either H or L positions and EN must not be left unconnected.
JP2	U1 V <sub>SET</sub> /FB	User can program the output voltage. Place a shunt across the H and V <sub>SET</sub> pins of JP2 to set the output of U1 to the default value of 2.2 V. Place a shunt across the L and V <sub>SET</sub> pins of JP2 to the output of U1 to the default value of 3.3 V.
JP3	U2 EN	Enable input for the U2 device. Place a shunt across the H and EN pins of JP3 to enable U2. Place a shunt across the L and EN pins of JP3 to disable U2. A shunt must be installed on JP3 in either H or L positions and EN should not be left unconnected.
JP4	U2 V <sub>SET</sub> /FB	User to program the output voltage. Place a shunt across the H and V <sub>SET</sub> pins of JP4 to set the output of U2 to the default value of 2.2 V. Place a shunt across the L and V <sub>SET</sub> pins of JP4 to the output of U2 to the default value of 3.3 V.

## 3 Operation

To setup the EVM Board operation

1. Connect the positive input power supply to the V<sub>IN</sub> pins on J1/J5.
2. Connect the input power return (ground) to the GND pins on J2/J6. The TPS780xxEVM-301 has a maximum input voltage of 6 V. The recommended maximum operating input voltage is 5.5 V.
3. Connect the desired load between the V<sub>out</sub> (J3/J7) and GND (J4/J8). The TPS780xxx supplies up to 150 mA of output current.
4. Configure jumpers JP1/JP3 and JP2/JP4 according to Table 1 and as required for your application.

## 4 Test Results

This section provides typical performance waveforms (Figure 1 through Figure 4) using the TPS780xxxEVM-301 printed circuit board.

**Figure 1. Startup from Enable**

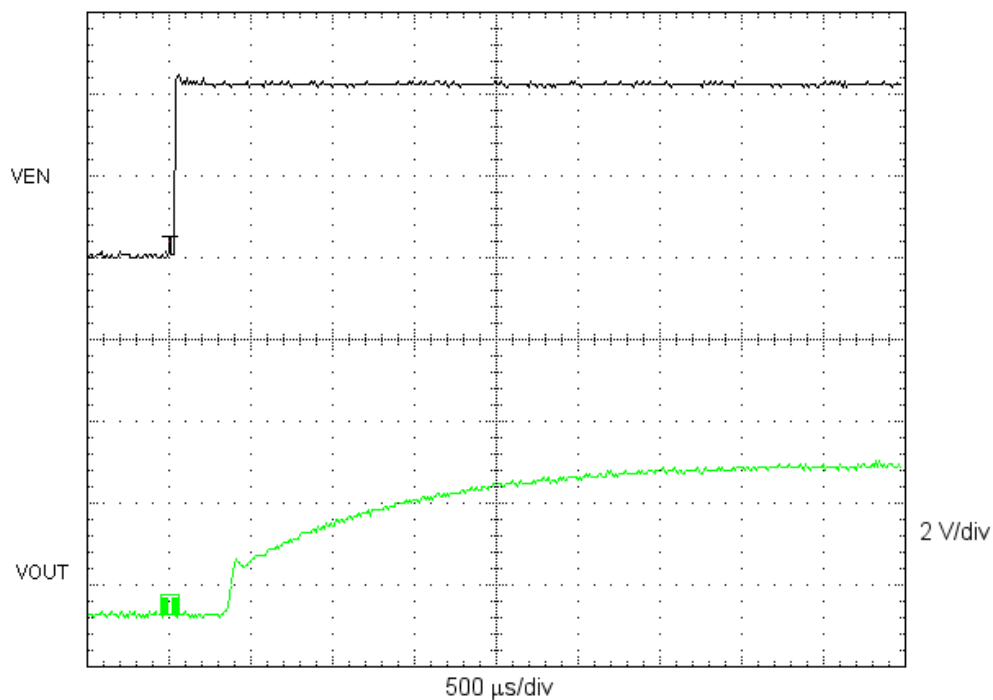

**Figure 2. Load Transient,  $V_I = 3.6\text{ V}$ ,  $V_{OUT} = 2.5\text{ V}$ ,  $I_{OUT} = 100\text{ mA}$  to  $150\text{ mA}$  returning to  $100\text{ mA}$**

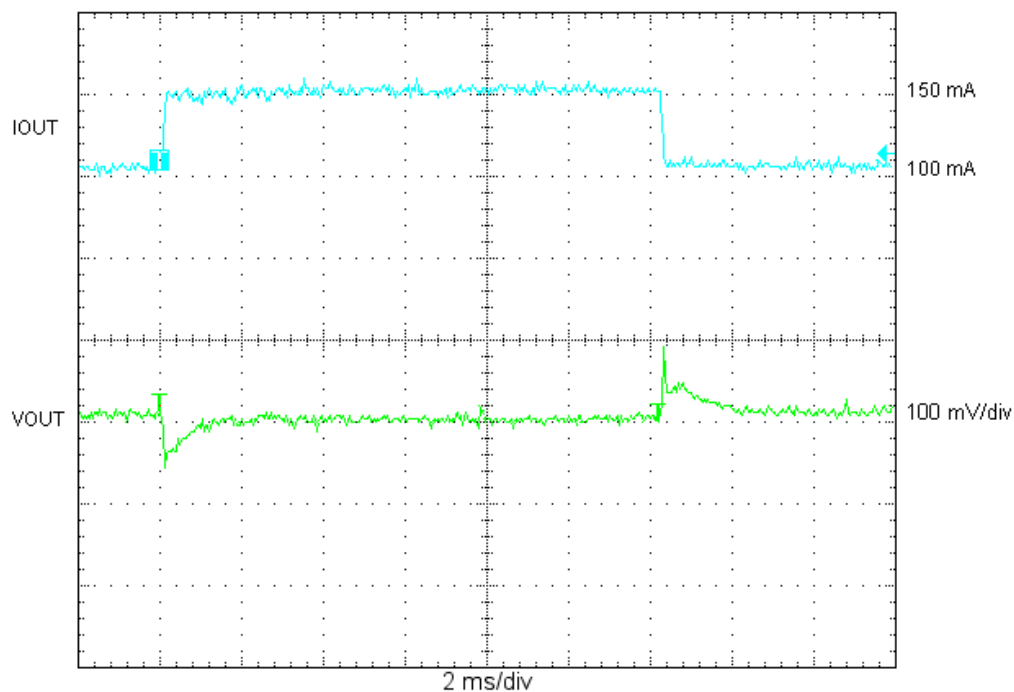

**Figure 3. Low to High Output Transient (VOUT = 2.2 V to 3.3 V, R<sub>LOAD</sub> = 22Ω)**

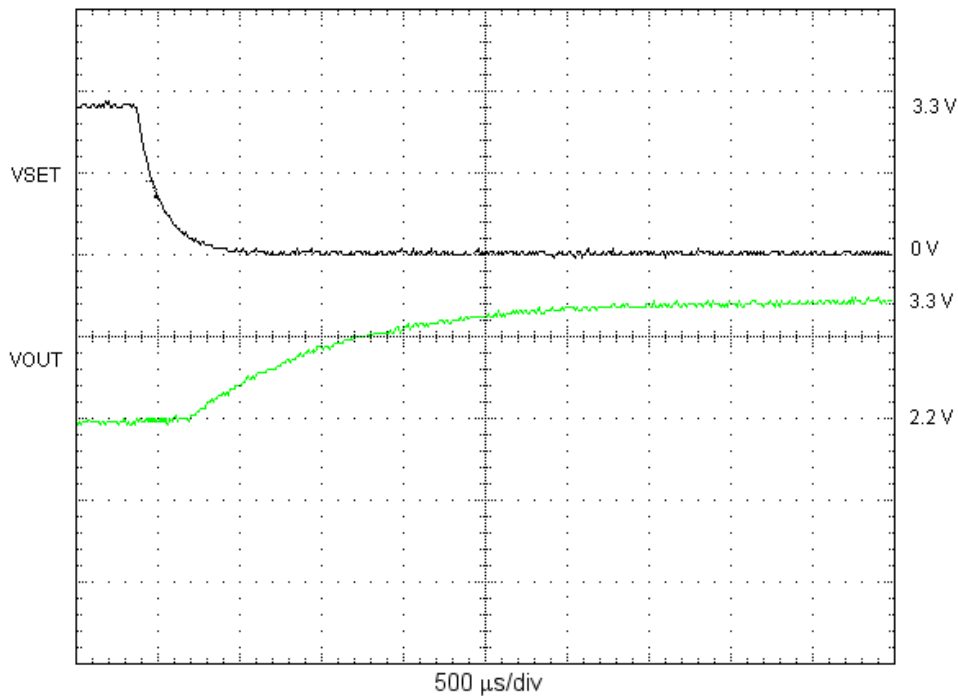

**Figure 4. High to Low Output Transient (VOUT = 3.3 V to 2.2 V, R<sub>LOAD</sub> = 22Ω)**

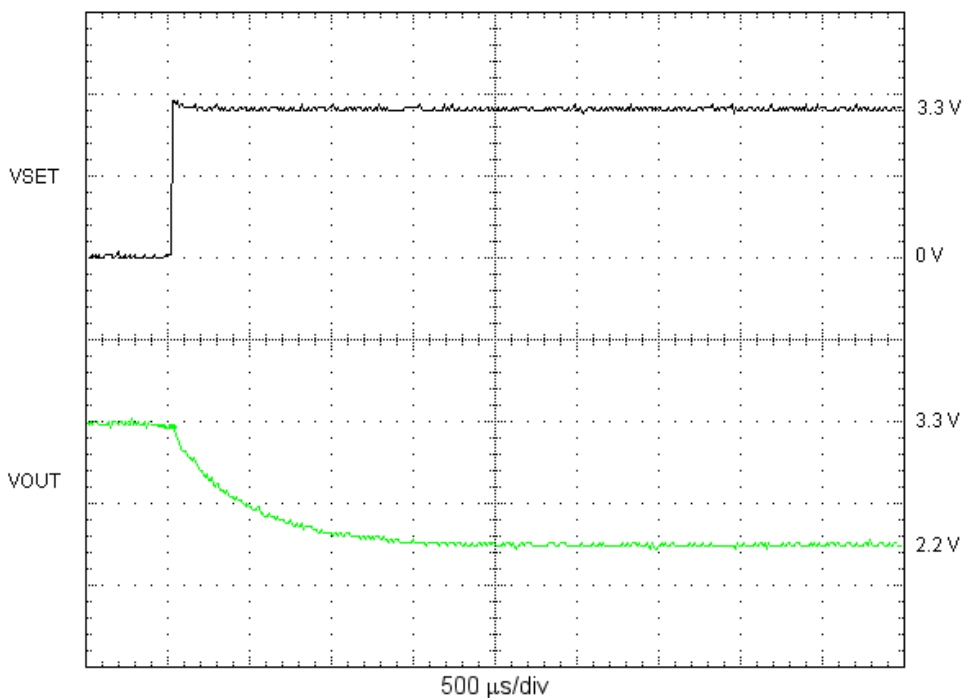

## 5 Board Layout, Schematic, and Bill of Materials

This section provides the TPS780xxxEVM-301 board layout, schematic, and bill of materials.

### 5.1 Board Layout

Board layout is critical for all high-frequency switch mode power supplies. If the layout is not carefully done, the regulator could show stability problems as well as EMI problems. Therefore, use wide and short traces for the main current path and for the power ground tracks. The input and output capacitor, plus the inductor should be placed as close as possible to the IC. Use a common ground node for power ground to minimize the effects of ground noise. [Figure 5](#) through [Figure 7](#) shows the board layout for the TPS780xxEVM-301 PCB.

Figure 5. Top Assembly Layer

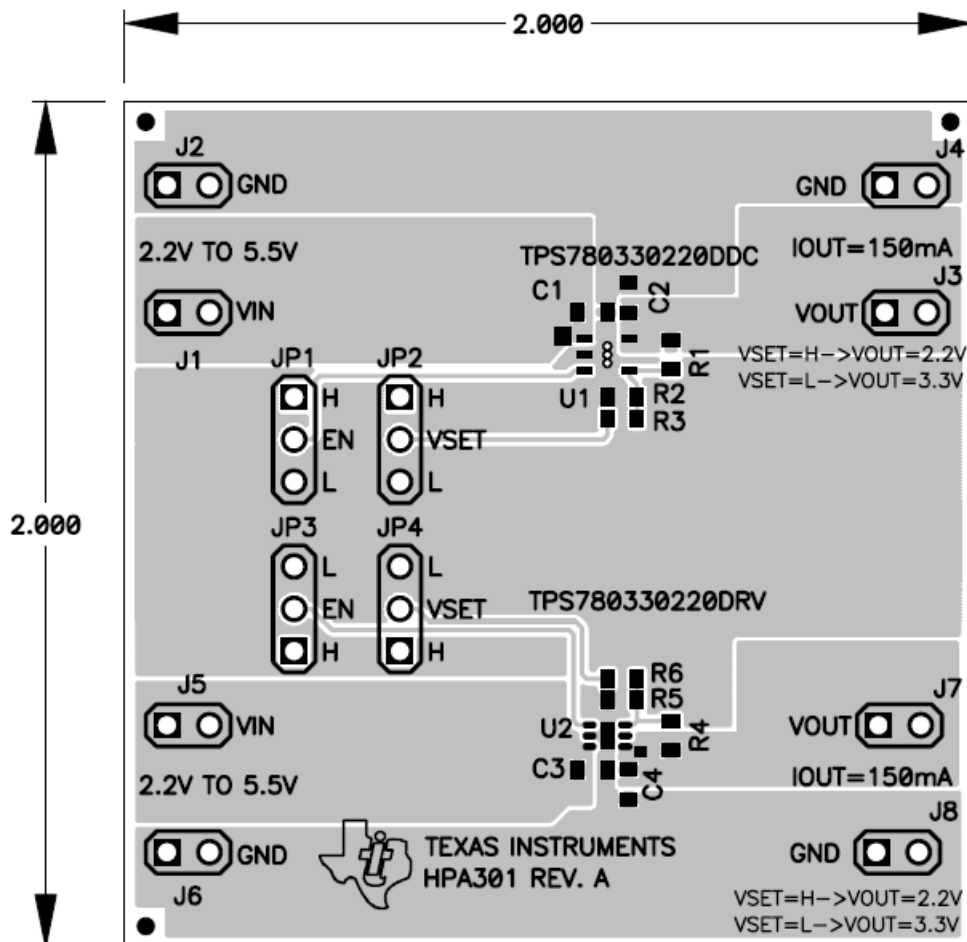
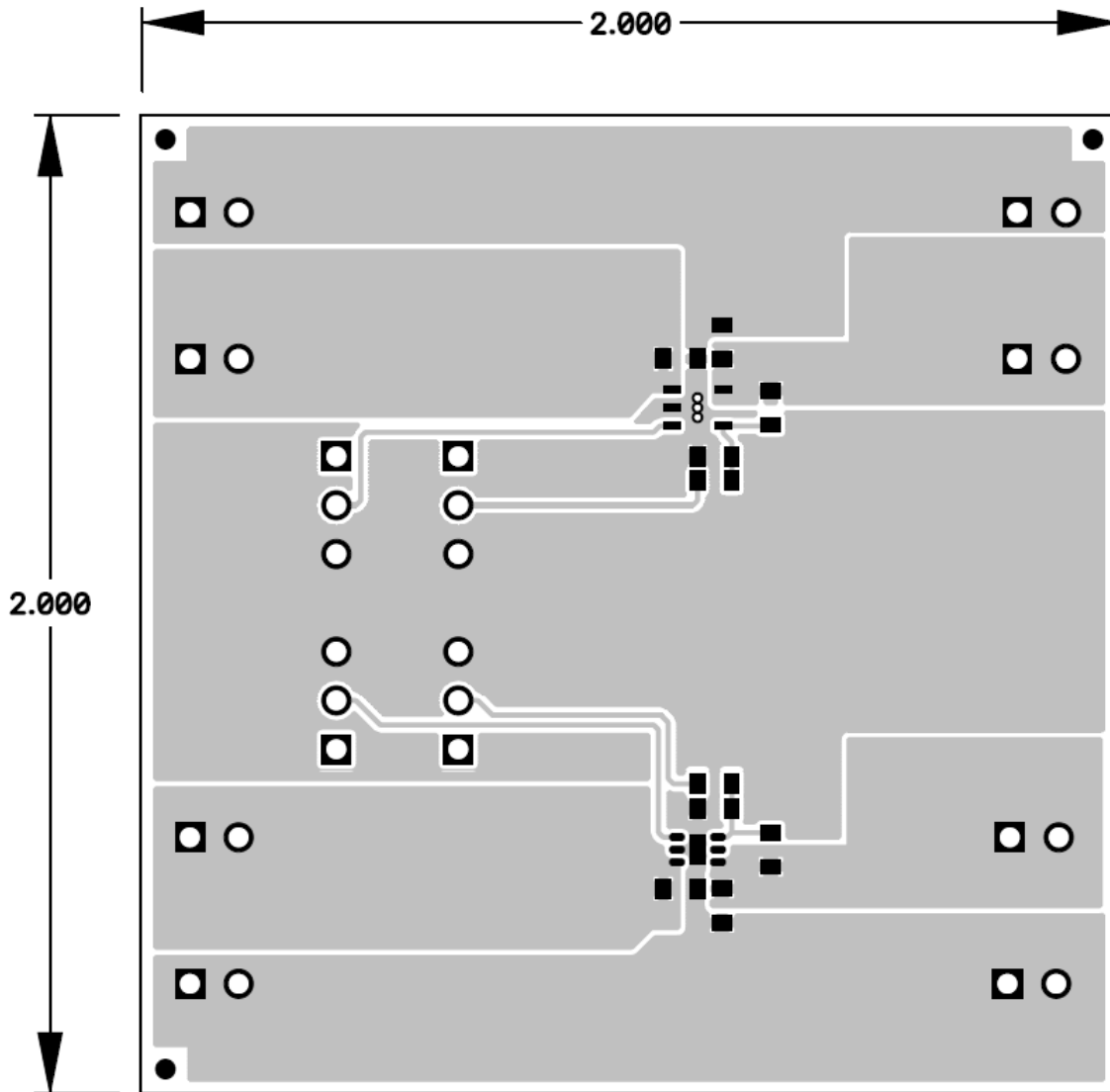
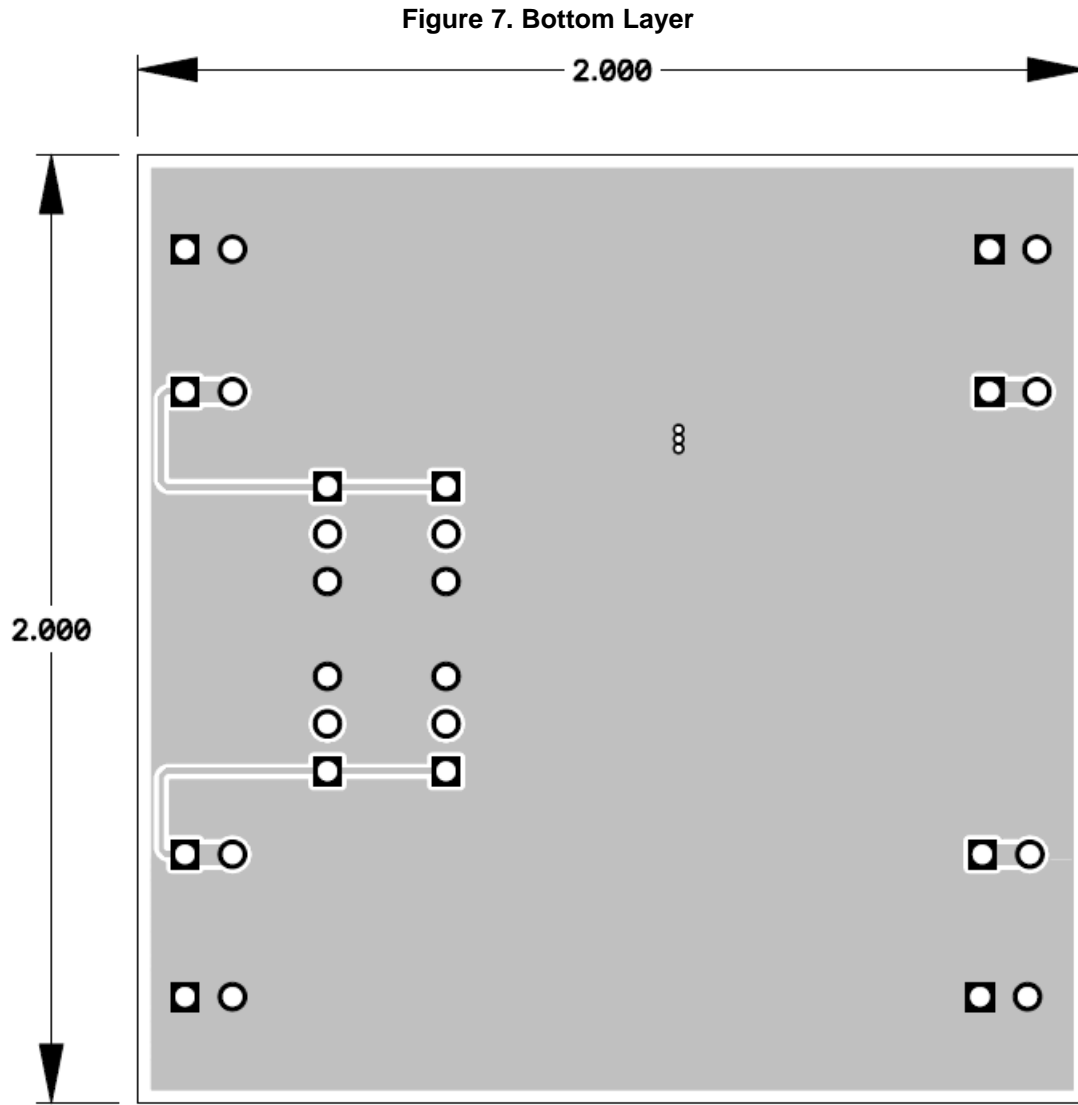

Figure 6. Top Layer





## 5.2 Schematic

Figure 8. TPS780xxEVM-301 Schematic

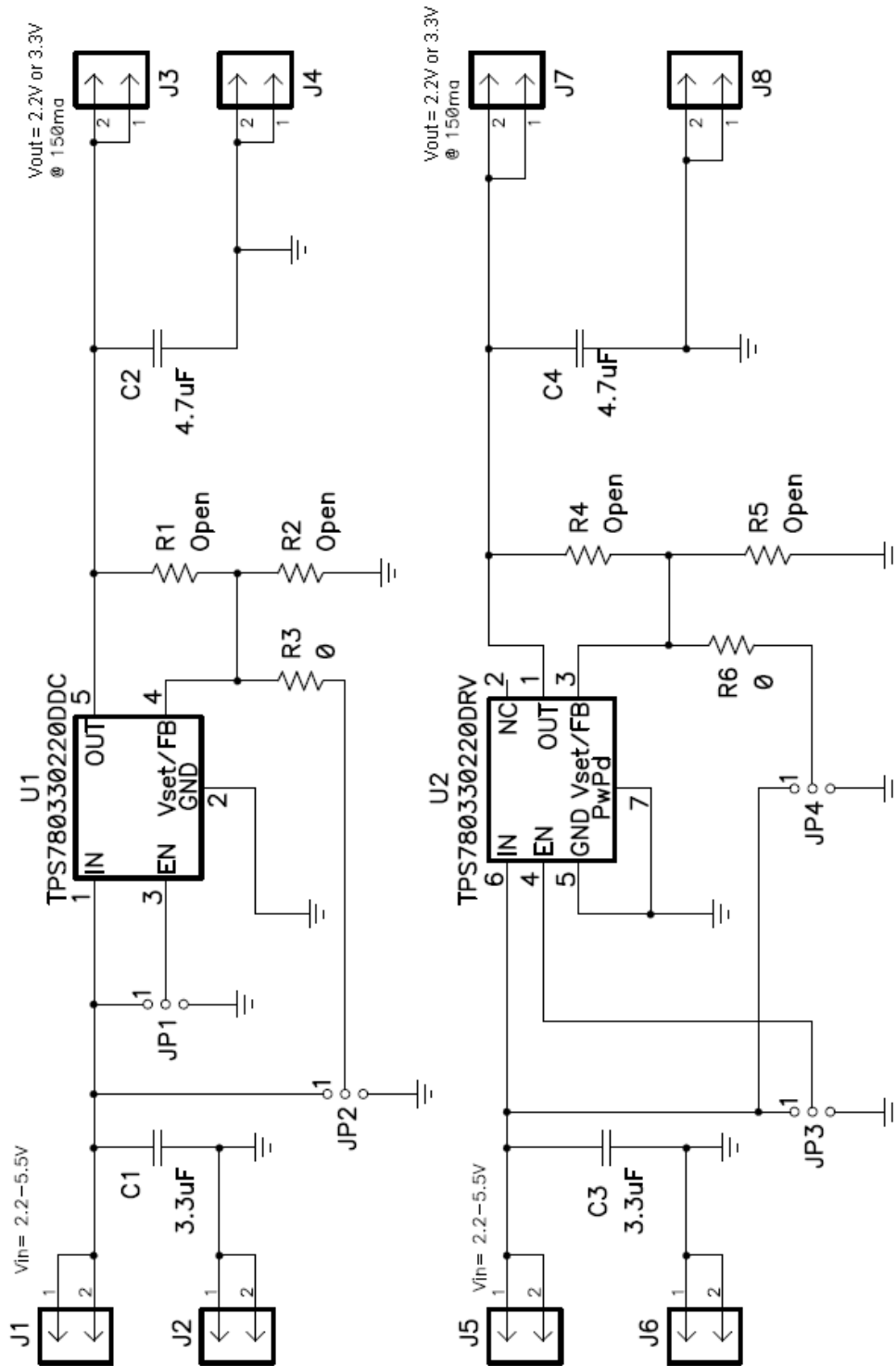



### 5.3 Bill of Materials

**Table 2. TPS780xxEVM-301 Bill of Materials**

Count	RefDes	Value	Description	Size	Part Number	Manufacturer
2	C1, C3	3.3 $\mu$ F	Capacitor, Ceramic, 10 V, X5R, 10%	0603	GRM188R61A335KE15B	muRata
2	C2, C4	4.7 $\mu$ F	Capacitor, Ceramic, 6.3 V, X5R, 10%	0603	GRM188R60J475KE19B	muRata
8	J1, J2, J3, J4, J5, J6, J7, J8	PTC36SAAN	Header, Male 2-pin, 100 mil spacing, (36-pin strip)	0.100 inch x 2	PTC36SAAN	Sullins
4	JP1, JP2, JP3, JP4		Header, 3-pin, 100mil spacing, (36-pin strip)	0.100 inch x 3	PTC36SAAN	Sullins
0	R1, R2	Open	Resistor, Chip, 1/16W	0603	Std	Std
2	R3, R6	0	Resistor, Chip, 1/16W, 1%	0603	CRCW0603-0000-Z	Vishay
0	R4, R5	Open	Resistor, Chip, 1/16W, 1%	0603	N/A	Vishay
4	–		Shunt, 100 mil, Black	0.1	929950-00	3M
1	U1	TPS780330220DDC	IC, Dual OutPut LDO Linear Regulator Iq 500 nA With Pin-Selectable	TSOT23-5	TPS780330220DDC	TI
1	U2	TPS780330220DRV	IC, Dual OutPut LDO Linear Regulator Iq 500 nA With Pin-Selectable	TSOT23-5	TPS780330220DRV	TI
1	–		PCB, 2 In x 2 In x 0.0062 In		HPA301	Any

## EVALUATION BOARD/KIT IMPORTANT NOTICE

Texas Instruments (TI) provides the enclosed product(s) under the following conditions:

This evaluation board/kit is intended for use for **ENGINEERING DEVELOPMENT, DEMONSTRATION, OR EVALUATION PURPOSES ONLY** and is not considered by TI to be a finished end-product fit for general consumer use. Persons handling the product(s) must have electronics training and observe good engineering practice standards. As such, the goods being provided are not intended to be complete in terms of required design-, marketing-, and/or manufacturing-related protective considerations, including product safety and environmental measures typically found in end products that incorporate such semiconductor components or circuit boards. This evaluation board/kit does not fall within the scope of the European Union directives regarding electromagnetic compatibility, restricted substances (RoHS), recycling (WEEE), FCC, CE or UL, and therefore may not meet the technical requirements of these directives or other related directives.

Should this evaluation board/kit not meet the specifications indicated in the User's Guide, the board/kit may be returned within 30 days from the date of delivery for a full refund. **THE FOREGOING WARRANTY IS THE EXCLUSIVE WARRANTY MADE BY SELLER TO BUYER AND IS IN LIEU OF ALL OTHER WARRANTIES, EXPRESSED, IMPLIED, OR STATUTORY, INCLUDING ANY WARRANTY OF MERCHANTABILITY OR FITNESS FOR ANY PARTICULAR PURPOSE.**

The user assumes all responsibility and liability for proper and safe handling of the goods. Further, the user indemnifies TI from all claims arising from the handling or use of the goods. Due to the open construction of the product, it is the user's responsibility to take any and all appropriate precautions with regard to electrostatic discharge.

**EXCEPT TO THE EXTENT OF THE INDEMNITY SET FORTH ABOVE, NEITHER PARTY SHALL BE LIABLE TO THE OTHER FOR ANY INDIRECT, SPECIAL, INCIDENTAL, OR CONSEQUENTIAL DAMAGES.**

TI currently deals with a variety of customers for products, and therefore our arrangement with the user **is not exclusive.**

TI assumes **no liability for applications assistance, customer product design, software performance, or infringement of patents or services described herein.**

Please read the User's Guide and, specifically, the Warnings and Restrictions notice in the User's Guide prior to handling the product. This notice contains important safety information about temperatures and voltages. For additional information on TI's environmental and/or safety programs, please contact the TI application engineer or visit [www.ti.com/esh](http://www.ti.com/esh).

No license is granted under any patent right or other intellectual property right of TI covering or relating to any machine, process, or combination in which such TI products or services might be or are used.

### FCC Warning

This evaluation board/kit is intended for use for **ENGINEERING DEVELOPMENT, DEMONSTRATION, OR EVALUATION PURPOSES ONLY** and is not considered by TI to be a finished end-product fit for general consumer use. It generates, uses, and can radiate radio frequency energy and has not been tested for compliance with the limits of computing devices pursuant to part 15 of FCC rules, which are designed to provide reasonable protection against radio frequency interference. Operation of this equipment in other environments may cause interference with radio communications, in which case the user at his own expense will be required to take whatever measures may be required to correct this interference.

Mailing Address: Texas Instruments, Post Office Box 655303, Dallas, Texas 75265  
Copyright © 2008, Texas Instruments Incorporated

### EVM WARNINGS AND RESTRICTIONS

It is important to operate this EVM within the input voltage range of 2.2 V to 5.5 V and the output voltage range of 0.8 V to 5.5 V.

Exceeding the specified input range may cause unexpected operation and/or irreversible damage to the EVM. If there are questions concerning the input range, please contact a TI field representative prior to connecting the input power.

Applying loads outside of the specified output range may result in unintended operation and/or possible permanent damage to the EVM. Please consult the EVM User's Guide prior to connecting any load to the EVM output. If there is uncertainty as to the load specification, please contact a TI field representative.

During normal operation, some circuit components may have case temperatures greater than 85°C. The EVM is designed to operate properly with certain components above 85°C as long as the input and output ranges are maintained. These components include but are not limited to linear regulators, switching transistors, pass transistors, and current sense resistors. These types of devices can be identified using the EVM schematic located in the EVM User's Guide. When placing measurement probes near these devices during operation, please be aware that these devices may be very warm to the touch.

Mailing Address: Texas Instruments, Post Office Box 655303, Dallas, Texas 75265  
Copyright © 2008, Texas Instruments Incorporated

## IMPORTANT NOTICE

Texas Instruments Incorporated and its subsidiaries (TI) reserve the right to make corrections, modifications, enhancements, improvements, and other changes to its products and services at any time and to discontinue any product or service without notice. Customers should obtain the latest relevant information before placing orders and should verify that such information is current and complete. All products are sold subject to TI's terms and conditions of sale supplied at the time of order acknowledgment.

TI warrants performance of its hardware products to the specifications applicable at the time of sale in accordance with TI's standard warranty. Testing and other quality control techniques are used to the extent TI deems necessary to support this warranty. Except where mandated by government requirements, testing of all parameters of each product is not necessarily performed.

TI assumes no liability for applications assistance or customer product design. Customers are responsible for their products and applications using TI components. To minimize the risks associated with customer products and applications, customers should provide adequate design and operating safeguards.

TI does not warrant or represent that any license, either express or implied, is granted under any TI patent right, copyright, mask work right, or other TI intellectual property right relating to any combination, machine, or process in which TI products or services are used. Information published by TI regarding third-party products or services does not constitute a license from TI to use such products or services or a warranty or endorsement thereof. Use of such information may require a license from a third party under the patents or other intellectual property of the third party, or a license from TI under the patents or other intellectual property of TI.

Reproduction of TI information in TI data books or data sheets is permissible only if reproduction is without alteration and is accompanied by all associated warranties, conditions, limitations, and notices. Reproduction of this information with alteration is an unfair and deceptive business practice. TI is not responsible or liable for such altered documentation. Information of third parties may be subject to additional restrictions.

Resale of TI products or services with statements different from or beyond the parameters stated by TI for that product or service voids all express and any implied warranties for the associated TI product or service and is an unfair and deceptive business practice. TI is not responsible or liable for any such statements.

TI products are not authorized for use in safety-critical applications (such as life support) where a failure of the TI product would reasonably be expected to cause severe personal injury or death, unless officers of the parties have executed an agreement specifically governing such use. Buyers represent that they have all necessary expertise in the safety and regulatory ramifications of their applications, and acknowledge and agree that they are solely responsible for all legal, regulatory and safety-related requirements concerning their products and any use of TI products in such safety-critical applications, notwithstanding any applications-related information or support that may be provided by TI. Further, Buyers must fully indemnify TI and its representatives against any damages arising out of the use of TI products in such safety-critical applications.

TI products are neither designed nor intended for use in military/aerospace applications or environments unless the TI products are specifically designated by TI as military-grade or "enhanced plastic." Only products designated by TI as military-grade meet military specifications. Buyers acknowledge and agree that any such use of TI products which TI has not designated as military-grade is solely at the Buyer's risk, and that they are solely responsible for compliance with all legal and regulatory requirements in connection with such use.

TI products are neither designed nor intended for use in automotive applications or environments unless the specific TI products are designated by TI as compliant with ISO/TS 16949 requirements. Buyers acknowledge and agree that, if they use any non-designated products in automotive applications, TI will not be responsible for any failure to meet such requirements.

Following are URLs where you can obtain information on other Texas Instruments products and application solutions:

### Products

Amplifiers	<a href="http://amplifier.ti.com">amplifier.ti.com</a>
Data Converters	<a href="http://dataconverter.ti.com">dataconverter.ti.com</a>
DSP	<a href="http://dsp.ti.com">dsp.ti.com</a>
Clocks and Timers	<a href="http://www.ti.com/clocks">www.ti.com/clocks</a>
Interface	<a href="http://interface.ti.com">interface.ti.com</a>
Logic	<a href="http://logic.ti.com">logic.ti.com</a>
Power Mgmt	<a href="http://power.ti.com">power.ti.com</a>
Microcontrollers	<a href="http://microcontroller.ti.com">microcontroller.ti.com</a>
RFID	<a href="http://www.ti-rfid.com">www.ti-rfid.com</a>
RF/IF and ZigBee® Solutions	<a href="http://www.ti.com/lprf">www.ti.com/lprf</a>

### Applications

Audio	<a href="http://www.ti.com/audio">www.ti.com/audio</a>
Automotive	<a href="http://www.ti.com/automotive">www.ti.com/automotive</a>
Broadband	<a href="http://www.ti.com/broadband">www.ti.com/broadband</a>
Digital Control	<a href="http://www.ti.com/digitalcontrol">www.ti.com/digitalcontrol</a>
Medical	<a href="http://www.ti.com/medical">www.ti.com/medical</a>
Military	<a href="http://www.ti.com/military">www.ti.com/military</a>
Optical Networking	<a href="http://www.ti.com/opticalnetwork">www.ti.com/opticalnetwork</a>
Security	<a href="http://www.ti.com/security">www.ti.com/security</a>
Telephony	<a href="http://www.ti.com/telephony">www.ti.com/telephony</a>
Video & Imaging	<a href="http://www.ti.com/video">www.ti.com/video</a>
Wireless	<a href="http://www.ti.com/wireless">www.ti.com/wireless</a>

Mailing Address: Texas Instruments, Post Office Box 655303, Dallas, Texas 75265  
Copyright © 2008, Texas Instruments Incorporated