

# Converter - Brake - Inverter Module XPT IGBT

Three Phase Rectifier	Brake Chopper	Three Phase Inverter
$V_{RRM} = 1600 \text{ V}$	$V_{CES} = 1200 \text{ V}$	$V_{CES} = 1200 \text{ V}$
$I_{DAVM25} = 100 \text{ A}$	$I_{C25} = 28 \text{ A}$	$I_{C25} = 28 \text{ A}$
$I_{FSM} = 270 \text{ A}$	$V_{CE(sat)} = 1.8 \text{ V}$	$V_{CE(sat)} = 1.8 \text{ V}$

**Part name** (Marking on product)

MIXA20WB1200TMH

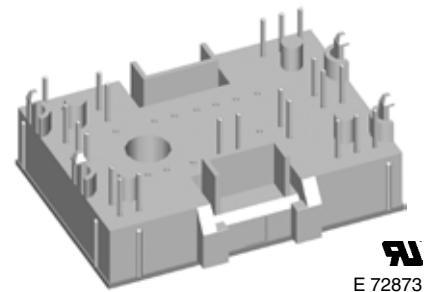
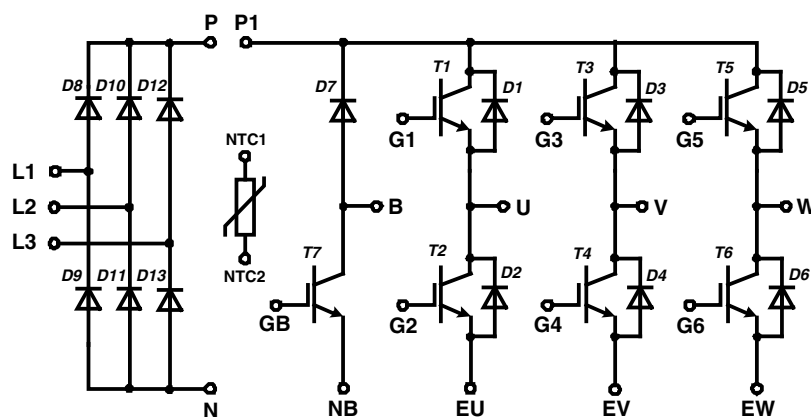

E 72873

Pin configuration see outlines.

### Features:

- High level of integration - only one power semiconductor module required for the whole drive
- Rugged XPT design (Xtreme light Punch Through) results in:
  - short circuit rated for 10  $\mu\text{sec}$ .
  - very low gate charge
  - square RBSOA @  $3 \times I_c$
  - low EMI
- Thin wafer technology combined with the XPT design results in a competitive low  $V_{CE(sat)}$
- Temperature sense included
- SONIC™ diode
  - fast and soft reverse recovery
  - low operating forward voltage

### Application:

- AC motor drives
- Pumps, Fans
- Washing machines
- Air-conditioning system
- Inverter and power supplies

### Package:

- "Mini" package
- Assembly height is 17 mm
- Insulated base plate
- Pins suitable for wave soldering and PCB mounting
- Assembly clips available
  - IXKU 5-505 screw clamp
  - IXRB 5-506 click clamp
- UL registered E72873

**Output Inverter T1 - T6**

Symbol	Definitions	Conditions	Ratings			Unit	
			min.	typ.	max.		
$V_{CES}$	collector emitter voltage		$T_{VJ} = 25^{\circ}\text{C}$		1200	V	
$V_{GES}$	max. DC gate voltage	continuous			$\pm 20$	V	
$V_{GEM}$	max. transient collector gate voltage	transient			$\pm 30$	V	
$I_{C25}$	collector current		$T_C = 25^{\circ}\text{C}$		28	A	
$I_{C80}$			$T_C = 80^{\circ}\text{C}$		20	A	
$P_{tot}$	total power dissipation		$T_C = 25^{\circ}\text{C}$		100	W	
$V_{CE(sat)}$	collector emitter saturation voltage	$I_C = 16\text{ A}; V_{GE} = 15\text{ V}$	$T_{VJ} = 25^{\circ}\text{C}$ $T_{VJ} = 125^{\circ}\text{C}$	1.8 2.1	2.1	V V	
$V_{GE(th)}$	gate emitter threshold voltage	$I_C = 0.6\text{ mA}; V_{GE} = V_{CE}$	$T_{VJ} = 25^{\circ}\text{C}$	5	5.5	6.5	V
$I_{CES}$	collector emitter leakage current	$V_{CE} = V_{CES}; V_{GE} = 0\text{ V}$	$T_{VJ} = 25^{\circ}\text{C}$ $T_{VJ} = 125^{\circ}\text{C}$		0.1	0.1	mA mA
$I_{GES}$	gate emitter leakage current	$V_{GE} = \pm 20\text{ V}$			500	nA	
$Q_{G(on)}$	total gate charge	$V_{CE} = 600\text{ V}; V_{GE} = 15\text{ V}; I_C = 15\text{ A}$			48	nC	
$t_{d(on)}$	turn-on delay time	inductive load $V_{CE} = 600\text{ V}; I_C = 15\text{ A}$ $V_{GE} = \pm 15\text{ V}; R_G = 56\ \Omega$	$T_{VJ} = 125^{\circ}\text{C}$		70	ns	
$t_r$	current rise time				40	ns	
$t_{d(off)}$	turn-off delay time				250	ns	
$t_f$	current fall time				100	ns	
$E_{on}$	turn-on energy per pulse				1.55	mJ	
$E_{off}$	turn-off energy per pulse				1.7	mJ	
<b>RBSOA</b>	reverse bias safe operating area	$V_{GE} = \pm 15\text{ V}; R_G = 56\ \Omega; V_{CEK} = 1200\text{ V}$	$T_{VJ} = 125^{\circ}\text{C}$		45	A	
<b><math>I_{SC}</math> (SCSOA)</b>	short circuit safe operating area	$V_{CE} = 900\text{ V}; V_{GE} = \pm 15\text{ V};$ $R_G = 56\ \Omega; t_p = 10\ \mu\text{s};$ non-repetitive	$T_{VJ} = 125^{\circ}\text{C}$		60	A	
$R_{thJC}$	thermal resistance junction to case	(per IGBT)			1.26	K/W	
$R_{thCH}$	thermal resistance case to heatsink			0.42		K/W	

**Output Inverter D1 - D6**

Symbol	Definitions	Conditions	Ratings			Unit
			min.	typ.	max.	
$V_{RRM}$	max. repetitive reverse voltage		$T_{VJ} = 25^{\circ}\text{C}$		1200	V
$I_{F25}$	forward current		$T_C = 25^{\circ}\text{C}$		33	A
$I_{F80}$			$T_C = 80^{\circ}\text{C}$		22	A
$V_F$	forward voltage	$I_F = 20\text{ A}; V_{GE} = 0\text{ V}$	$T_{VJ} = 25^{\circ}\text{C}$ $T_{VJ} = 125^{\circ}\text{C}$	1.95 1.95	2.2	V V
$Q_{rr}$	reverse recovery charge	$V_R = 600\text{ V}$ $di_F/dt = -400\text{ A}/\mu\text{s}$ $I_F = 20\text{ A}; V_{GE} = 0\text{ V}$	$T_{VJ} = 125^{\circ}\text{C}$		3	$\mu\text{C}$
$I_{RM}$	max. reverse recovery current				20	A
$t_{rr}$	reverse recovery time				350	ns
$E_{rec}$	reverse recovery energy				0.7	mJ
$R_{thJC}$	thermal resistance junction to case	(per diode)			1.5	K/W
$R_{thCH}$	thermal resistance case to heatsink			0.5		K/W

**Brake T7**

Symbol	Definitions	Conditions	Ratings			Unit
			min.	typ.	max.	
$V_{CES}$	collector emitter voltage	$T_{VJ} = 25^{\circ}\text{C}$			1200	V
$V_{GES}$	max. DC gate voltage	continuous			$\pm 20$	V
$V_{GEM}$	max. transient collector gate voltage	transient			$\pm 30$	V
$I_{C25}$	collector current	$T_C = 25^{\circ}\text{C}$			28	A
$I_{C80}$		$T_C = 80^{\circ}\text{C}$			20	A
$P_{tot}$	total power dissipation	$T_C = 25^{\circ}\text{C}$			100	W
$V_{CE(sat)}$	collector emitter saturation voltage	$I_C = 16\text{ A}; V_{GE} = 15\text{ V}$			1.8 2.1	V V
$V_{GE(th)}$	gate emitter threshold voltage	$I_C = 0.6\text{ mA}; V_{GE} = V_{CE}$	5	5.5	6.5	V
$I_{CES}$	collector emitter leakage current	$V_{CE} = V_{CES}; V_{GE} = 0\text{ V}$			0.01 0.1	mA mA
$I_{GES}$	gate emitter leakage current	$V_{GE} = \pm 20\text{ V}$			500	nA
$Q_{G(on)}$	total gate charge	$V_{CE} = 600\text{ V}; V_{GE} = 15\text{ V}; I_C = 15\text{ A}$		48		nC
$t_{d(on)}$	turn-on delay time	inductive load $V_{CE} = 600\text{ V}; I_C = 15\text{ A}$ $V_{GE} = \pm 15\text{ V}; R_G = 56\ \Omega$	$T_{VJ} = 125^{\circ}\text{C}$		70	ns
$t_r$	current rise time				40	ns
$t_{d(off)}$	turn-off delay time				250	ns
$t_f$	current fall time				100	ns
$E_{on}$	turn-on energy per pulse				1.55	mJ
$E_{off}$	turn-off energy per pulse				1.7	mJ
<b>RBSOA</b>	reverse bias safe operating area	$V_{GE} = \pm 15\text{ V}; R_G = 56\ \Omega; V_{CEK} = 1200\text{ V}$			45	A
		$T_{VJ} = 125^{\circ}\text{C}$				
<b><math>I_{SC}</math> (SCSOA)</b>	short circuit safe operating area	$V_{CE} = 900\text{ V}; V_{GE} = \pm 15\text{ V};$ $R_G = 56\ \Omega; t_p = 10\ \mu\text{s};$ non-repetitive		60		A
$R_{thJC}$	thermal resistance junction to case	(per IGBT)			1.26	K/W
$R_{thCH}$	thermal resistance case to heatsink		0.42			K/W

**Brake Chopper D7**

Symbol	Definitions	Conditions	Ratings			Unit
			min.	typ.	max.	
$V_{RRM}$	max. repetitive reverse voltage	$T_{VJ} = 150^{\circ}\text{C}$			1200	V
$I_{F25}$	forward current	$T_C = 25^{\circ}\text{C}$			12	A
$I_{F80}$		$T_C = 80^{\circ}\text{C}$			8	A
$V_F$	forward voltage	$I_F = 5\text{ A}; V_{GE} = 0\text{ V}$			1.95 1.95	V V
$I_R$	reverse current	$V_R = V_{RRM}$			0.01 0.1	mA mA
$Q_{rr}$	reverse recovery charge	$V_R = 600\text{ V}$ $di_F/dt = 200\text{ A}/\mu\text{s}$ $I_F = 5\text{ A}; V_{GE} = 0\text{ V}$	$T_{VJ} = 125^{\circ}\text{C}$		0.6	$\mu\text{C}$
$I_{RM}$	max. reverse recovery current				6	A
$t_{rr}$	reverse recovery time				350	ns
$E_{rec}$	reverse recovery energy				0.15	mJ
$R_{thJC}$	thermal resistance junction to case	(per diode)			3.4	K/W
$R_{thCH}$	thermal resistance case to heatsink		1.1			K/W

**Input Rectifier Bridge D8 - D11**

Symbol	Definitions	Conditions	Ratings			Unit
			min.	typ.	max.	
$V_{RRM}$	max. repetitive reverse voltage		$T_{VJ} = 25^{\circ}\text{C}$		1600	V
$I_{FAV}$	average forward current	sine $180^{\circ}$	$T_C = 80^{\circ}\text{C}$		24	A
$I_{DAVM}$	max. average DC output current	rect.; $d = 1/3$	$T_C = 80^{\circ}\text{C}$		69	A
$I_{FSM}$	max. forward surge current	$t = 10$ ms; sine 50 Hz	$T_{VJ} = 25^{\circ}\text{C}$ $T_{VJ} = 125^{\circ}\text{C}$		270 240	A A
$I^2t$	$I^2t$ value for fusing	$t = 10$ ms; sine 50 Hz	$T_{VJ} = 25^{\circ}\text{C}$ $T_{VJ} = 125^{\circ}\text{C}$		360 290	$\text{A}^2\text{s}$ $\text{A}^2\text{s}$
$P_{tot}$	total power dissipation		$T_C = 25^{\circ}\text{C}$		69	W
$V_F$	forward voltage	$I_F = 30$ A	$T_{VJ} = 25^{\circ}\text{C}$ $T_{VJ} = 125^{\circ}\text{C}$	1.27 1.24	1.6	V V
$I_R$	reverse current	$V_R = V_{RRM}$	$T_{VJ} = 25^{\circ}\text{C}$ $T_{VJ} = 125^{\circ}\text{C}$	0.3	0.01	mA mA
$R_{thJC}$	thermal resistance junction to case	(per diode)			1.8	K/W
$R_{thCH}$	thermal resistance case to heatsink	(per diode)		0.6		K/W

**Temperature Sensor NTC**

Symbol	Definitions	Conditions	Ratings			Unit	
			min.	typ.	max.		
$R_{25}$	resistance		$T_C = 25^{\circ}\text{C}$	4.75	5.0	5.25	$\text{k}\Omega$
$B_{25/50}$					3375		K

**Module**

Symbol	Definitions	Conditions	Ratings			Unit
			min.	typ.	max.	
$T_{VJ}$	operating temperature		-40		125	$^{\circ}\text{C}$
$T_{VJM}$	max. virtual junction temperature				150	$^{\circ}\text{C}$
$T_{stg}$	storage temperature		-40		125	$^{\circ}\text{C}$
$V_{ISOL}$	isolation voltage	$I_{ISOL} \leq 1$ mA; 50/60 Hz			2500	V~
CTI	comparative tracking index				-	
$F_C$	mounting force		40		80	N
$d_S$	creep distance on surface		12.7			mm
$d_A$	strike distance through air		12			mm
Weight				35		g

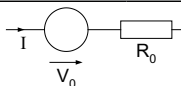
**Equivalent Circuits for Simulation**

Symbol	Definitions	Conditions	Ratings			Unit
			min.	typ.	max.	
$V_0$	rectifier diode	D8 - D13	$T_{VJ} = 150^{\circ}\text{C}$		0.86	V
$R_0$					12.3	$\text{m}\Omega$
$V_0$	IGBT	T1 - T6	$T_{VJ} = 150^{\circ}\text{C}$		1.1	V
$R_0$					86.3	$\text{m}\Omega$
$V_0$	free wheeling diode	D1 - D6	$T_{VJ} = 150^{\circ}\text{C}$		1.19	V
$R_0$					40.0	$\text{m}\Omega$
$V_0$	IGBT	T7	$T_{VJ} = 150^{\circ}\text{C}$		1.1	V
$R_0$					86.3	$\text{m}\Omega$
$V_0$	free wheeling diode	D7	$T_{VJ} = 150^{\circ}\text{C}$		1.15	V
$R_0$					171	$\text{m}\Omega$

IXYS reserves the right to change limits, test conditions and dimensions.

 $T_C = 25^{\circ}\text{C}$  unless otherwise stated

20101103b

### Circuit Diagram

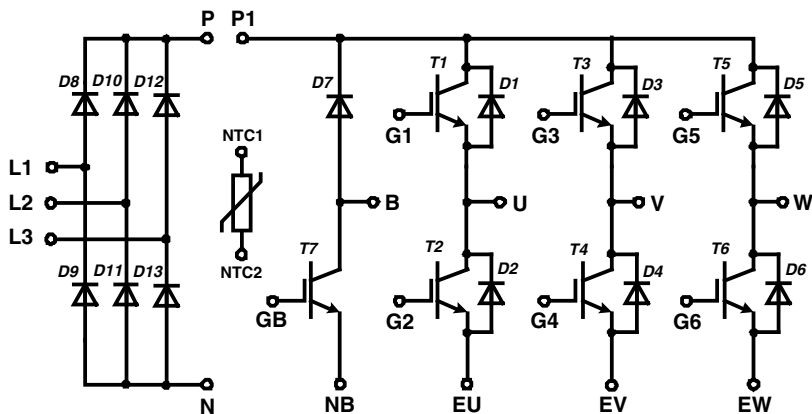

### Outline Drawing

Dimensions in mm (1 mm = 0.0394")

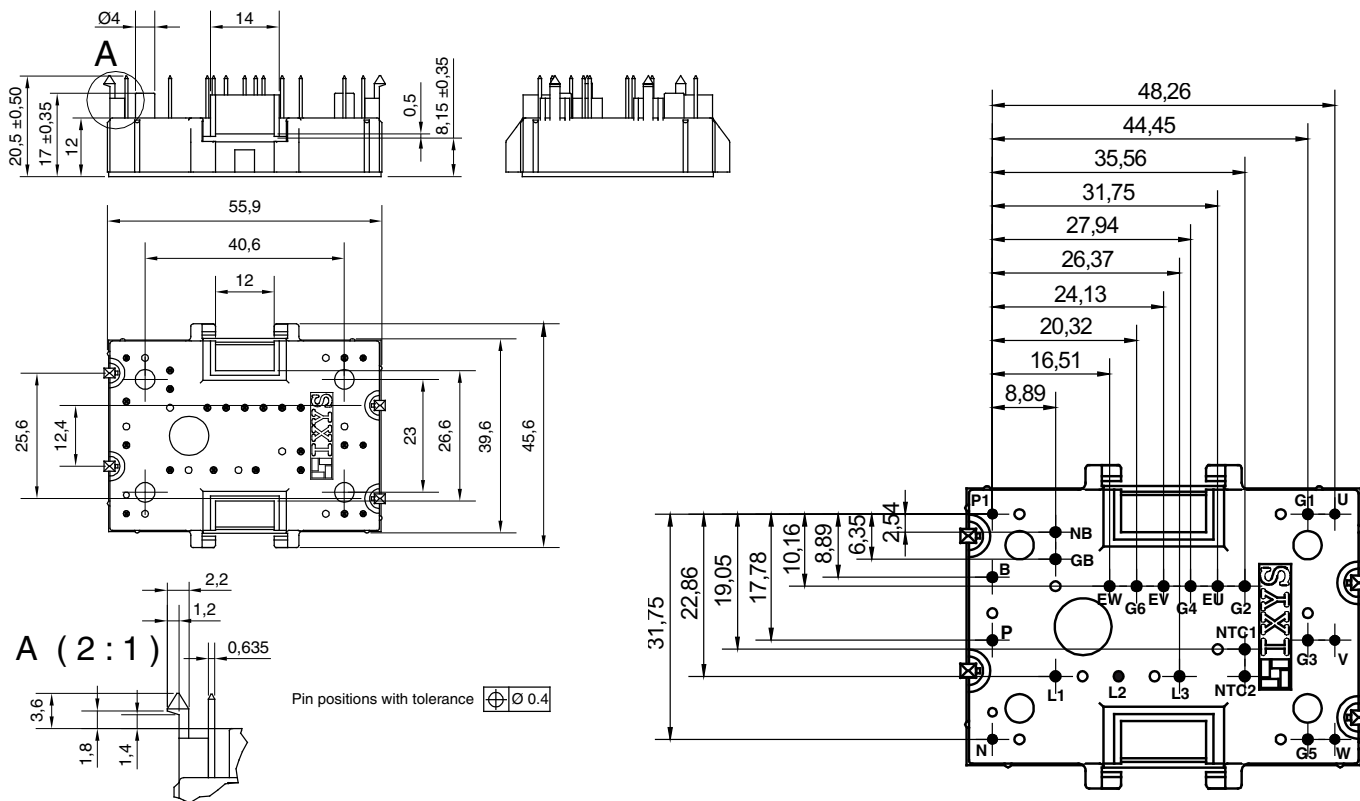

### Product Marking

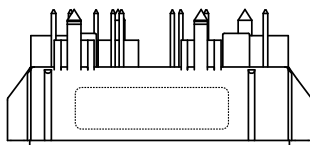

#### Part number

- M = Module
- I = IGBT
- X = XPT
- A = standard
- 20 = Current Rating [A]
- WB = 6-Pack + 3~ Rectifier Bridge & Brake Unit
- 1200 = Reverse Voltage [V]
- T = NTC
- MH = MiniPack2

Ordering	Part Name	Marking on Product	Delivering Mode	Base Qty	Ordering Code
Standard	MIXA 20 WB 1200 TMH	MIXA20WB1200TMH	Box	20	508616

## IGBT T1 - T6

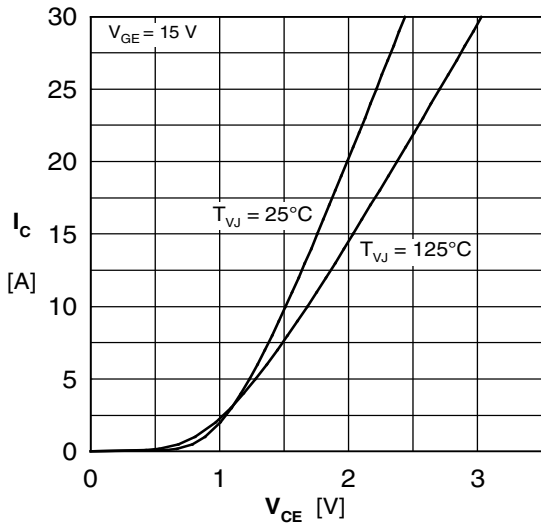

Fig. 1 Typ. output characteristics

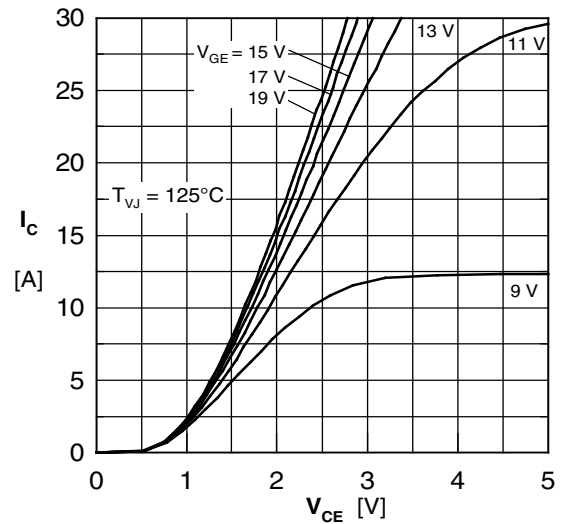

Fig. 2 Typ. output characteristics

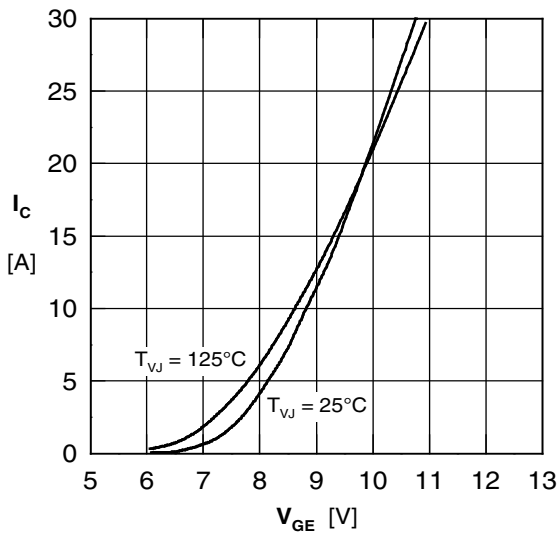

Fig. 3 Typ. transfer characteristics

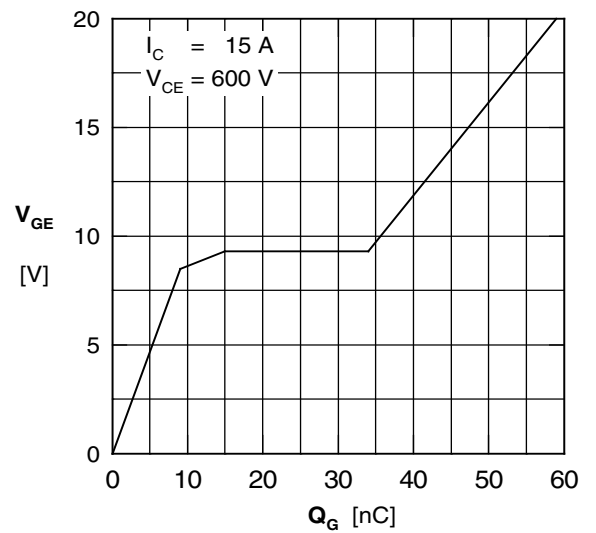

Fig. 4 Typ. turn-on gate charge

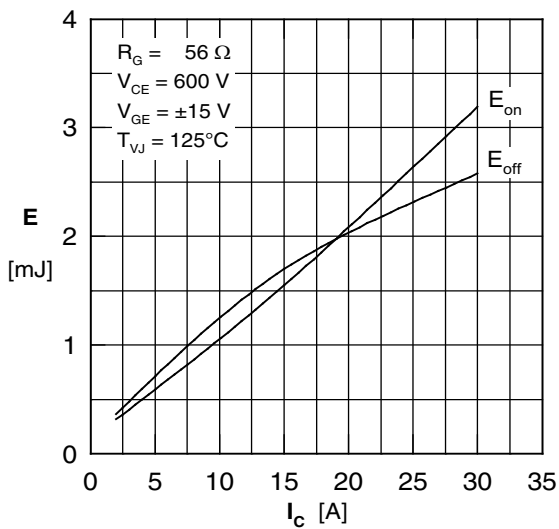

Fig. 5 Typ. switching energy vs. collector current

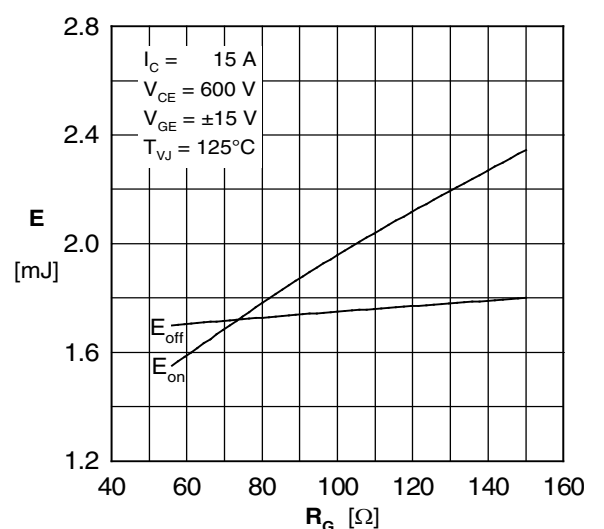

Fig. 6 Typ. switching energy vs. gate resistance

## Diode D1 - D6

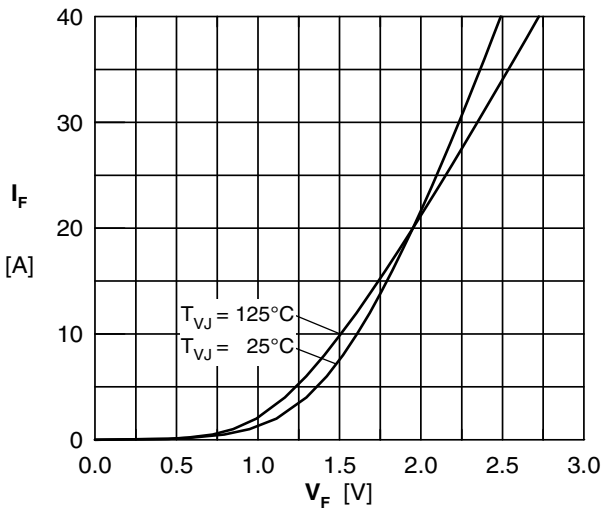

Fig. 7 Typ. Forward current versus  $V_F$

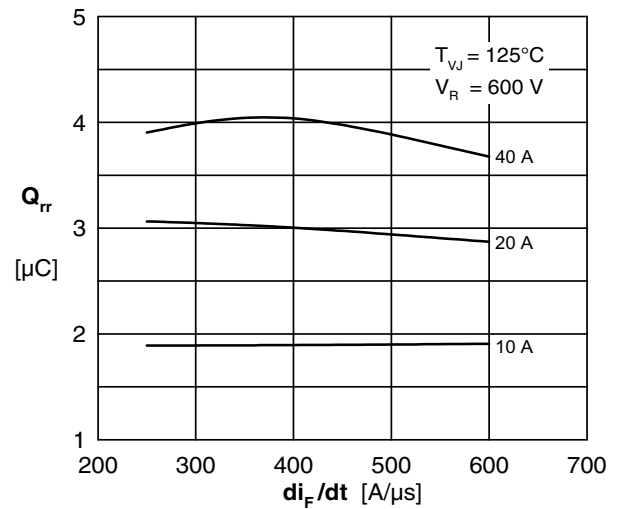

Fig. 8 Typ. reverse recov. charge  $Q_{rr}$  vs.  $di/dt$

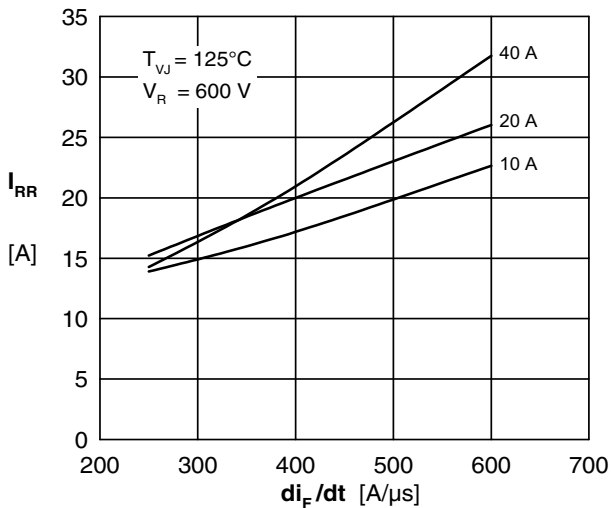

Fig. 9 Typ. peak reverse current  $I_{RRM}$  vs.  $di/dt$

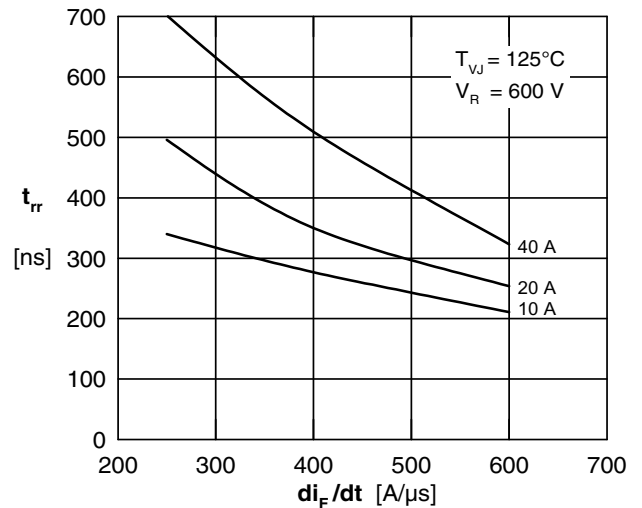

Fig. 10 Typ. recovery time  $t_{rr}$  versus  $di/dt$

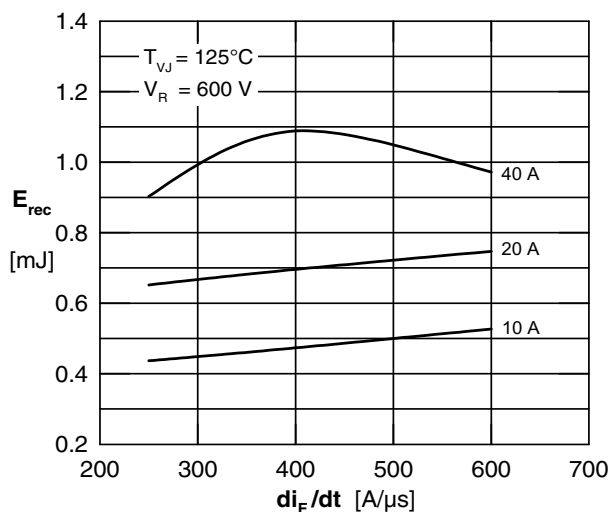

Fig. 11 Typ. recovery energy  $E_{rec}$  versus  $di/dt$

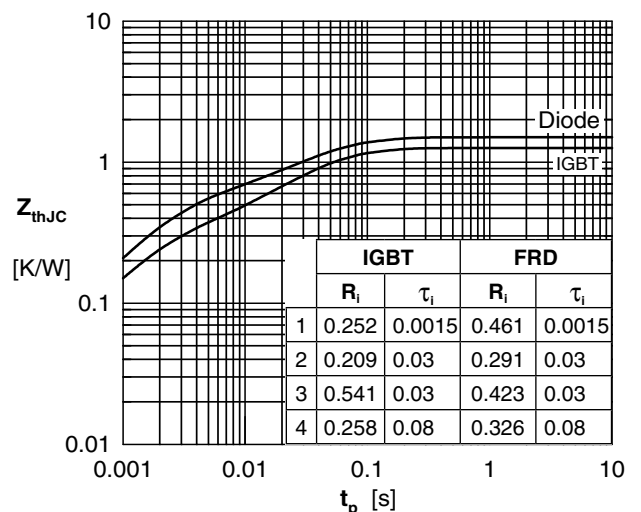

Fig. 12 Typ. transient thermal impedance

## NTC

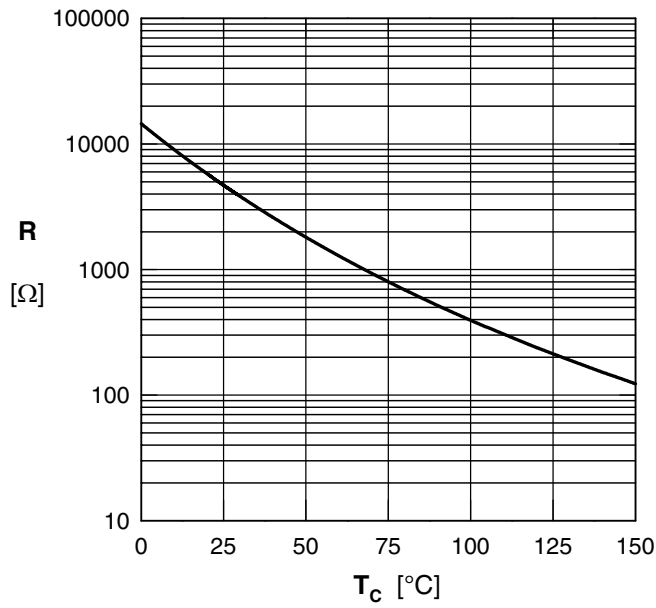

Fig. 13 Typ. thermistor resistance vs. temperature