



MIC2103/04 Evaluation Board

75V, Synchronous Buck Controllers
featuring Adaptive On-Time Control

Hyper Speed Control™ Family

General Description

The Micrel MIC2103/04 are constant-frequency, synchronous buck controllers featuring a unique adaptive on-time control architecture. The MIC2103/04 operates over an input supply range of 4.5V to 75V and can be used to supply up to 15A of output current. The output voltage is adjustable down to 0.8V with a guaranteed accuracy of $\pm 1\%$. The device operates with programmable switching frequency from 200kHz to 600kHz.

The MIC2103 has Hyper Light Load® architecture, so it can operate in pulse skipping mode at light load. However, from medium load to heavy load, it operates in fixed frequency CCM mode. The MIC2104 has Hyper Speed Control architecture which operates in fixed frequency CCM mode under all load conditions.

The basic parameters of the evaluation board are:

1. Input: 12V to 75V
2. Output: 0.8V to 5V at 10A ⁽¹⁾
3. 200kHz Switching Frequency (Adjustable 200kHz to 600kHz)

Note:

1. Refer to temperature curves shown in Typical Characteristics section.

Datasheets and support documentation can be found on Micrel's web site at: www.micrel.com.

Requirements

The MIC2103 and MIC2104 evaluation board requires only a single power supply with at least 10A current capability. The MIC2103/04 has internal VDD LDO so no external linear regulator is required to power the internal biasing of the IC. In the applications with $V_{IN} < +5.5V$, VDD should be tied to VIN to by-pass the internal linear regulator. The output load can either be a passive or an active load.

Precautions

The MIC2103/04 evaluation board does not have reverse polarity protection. Applying a negative voltage to the VIN and GND terminals may damage

the device. The maximum VIN of the board is rated at 75V. Exceeding 75V on the VIN could damage the device.

Getting Started

1. VIN Supply

Connect a supply to the VIN and GND terminals, paying careful attention to the polarity and the supply range ($12V < V_{IN} < 75V$). Monitor I_{IN} with a current meter and input voltage at VIN and GND terminals with voltmeter. Do not apply power until step 4.

2. Connect Load and Monitor Output

Connect a load to the VOUT and GND terminals. The load can be either a passive (resistive) or an active (as in an electronic load) type. A current meter may be placed between the VOUT terminal and load to monitor the output current. Ensure the output voltage is monitored at the VOUT terminal.

3. Enable Input

The EN pin has an on board 100k pull-up resistor (R22) to VIN, which allows the output to be turned on when VDD exceeds its UVLO threshold. An EN connector is provided on the evaluation board for users to easily access the enable feature. Applying an external logic signal on the EN pin to pull it low or using a jumper to short the EN pin to GND will shut off the output of the MIC2103/04 evaluation board.

4. Turn on the Power

Turn on the VIN supply and verify that the output voltage is regulated to 5.0V.

Ordering Information

Part Number	Description
MIC2103YML 10A EV	MIC2103 Evaluation Board up to 5V Output
MIC2104YML 10A EV	MIC2104 Evaluation Board up to 5V Output

Hyper Speed Control is a trademark of Micrel, Inc

Micrel Inc. • 2180 Fortune Drive • San Jose, CA 95131 • USA • tel +1 (408) 944-0800 • fax + 1 (408) 474-1000 • <http://www.micrel.com>

Features

Feedback Resistors

The output voltage on the MIC2103/04 evaluation board, which is preset to 5.0V, is determined by the feedback divider:

$$V_{OUT} = V_{REF} \times \left(1 + \frac{R1}{R_{BOTTOM}} \right) \quad (\text{Eq. 1})$$

where $V_{REF} = 0.8V$, and R_{BOTTOM} is one of R4, R5, R6, R7, R8, R9, R10, R11 which corresponds to 0.9V, 1.0V, 1.2V, 1.5V, 1.8V, 2.5V, 3.3V, or 5V. Leaving the R_{BOTTOM} open gives a 0.8V output voltage. All other voltages not listed above can be set by modifying R_{BOTTOM} value according to:

$$R_{BOTTOM} = \frac{R1 \times V_{REF}}{V_{OUT} - V_{REF}} \quad (\text{Eq. 2})$$

Note that the output voltage should not be set to exceed 5V due to the 6.3V voltage rating on the output capacitors.

SW Node

Test point J1 (VSW) is placed for monitoring the switching waveform, which is one of the most critical waveforms for the converter.

Current Limit

The MIC2103/04 uses the $R_{DS(ON)}$ and external resistor connected from ILIM pin to SW node to decide the current limit.

In each switching cycle of the MIC2103/04 converter, the inductor current is sensed by monitoring the low-side MOSFET in the OFF period. The sensed voltage $V(ILIM)$ is compared with the power ground (PGND) after a blanking time of 150ns. In this way the drop voltage over the resistor R17 (V_{CL}) is compared with the drop over the bottom FET generating the short current limit. The small capacitor (C18) connected from ILIM pin to PGND filters the switching node ringing during the off time to allow a better short limit measurement. The time constant created by R17 and C18 should be much less than the minimum off time.

The V_{CL} drop allows programming of short limit

through the value of the resistor (R17). If the absolute value of the voltage drop on the bottom FET is greater than V_{CL} , the $V(ILIM)$ is lower than PGND and a short circuit event is triggered. A hiccup cycle to treat the short event is generated. The hiccup sequence, including the soft start, reduces the stress on the switching FETs and protects the load and supply for severe short conditions.

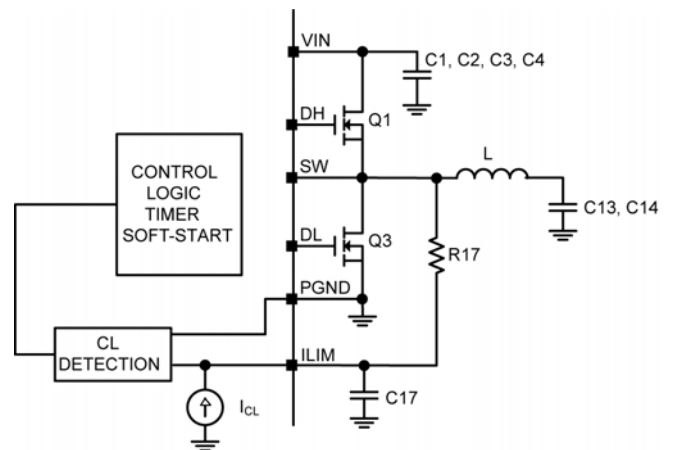

Figure 1. MIC2103/04 Current Limiting Circuit

The short circuit current limit can be programmed by using the following formula.

$$R17 = \frac{(I_{CLIM} - \Delta_{PP} \times 0.5) \times R_{DS(ON)} + V_{CL}}{I_{CL}} \quad (\text{Eq. 3})$$

Where I_{CLIM} = Desired Current limit

Δ_{PP} = Inductor current peak to peak

$R_{DS(ON)}$ = On resistance of low-side power MOSFET

V_{CL} = Current limit threshold, the typical value is 14mV in EC table

I_{CL} = Current Limit source current, the typical value is 80µA in EC table.

In case of a hard short, the short limit is folded down to allow an indefinite hard short on the output without any destructive effect. It is mandatory to make sure that the inductor current used to charge the output capacitance during soft start is under the folded short limit. Otherwise, the supply will go in hiccup mode and may not be finishing the soft start successfully.

The MOSFET $R_{DS(ON)}$ varies 30% to 40% with temperature; therefore, it is recommended to add a 50% margin to I_{CL} in the above equation to avoid false current limiting due to increased MOSFET junction temperature rise. It is also recommended to connect SW pin directly to the drain of the low-side MOSFET to accurately sense the MOSFET's $R_{DS(ON)}$.

Loop Gain Measurement

The resistor, R14, is placed in series with the regulator feedback path. The control loop gain can be measured by connecting an impedance analyzer across the resistor and selecting the resistor value in between 20Ω to 50Ω.

Setting the Switching Frequency

The MIC2103/04 are adjustable-frequency, synchronous buck controllers featuring a unique adaptive on-time control architecture. The switching frequency can be adjusted between 200kHz and 600kHz by changing the resistor divider network consisting of R19 and R20.

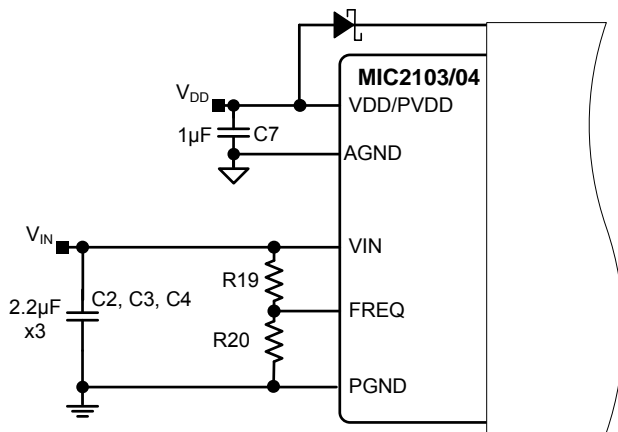

Figure 2. Switching Frequency Adjustment

The following formula gives the estimated switching frequency:

$$f_{SW_ADJ} = f_o \times \frac{R20}{R19 + R20} \quad (\text{Eq. 4})$$

Where f_o = Switching Frequency when R19 is 100k and R20 being open, f_o is typically 600kHz at 12V input voltage. For more precise setting, it is recommended to use the following graph:

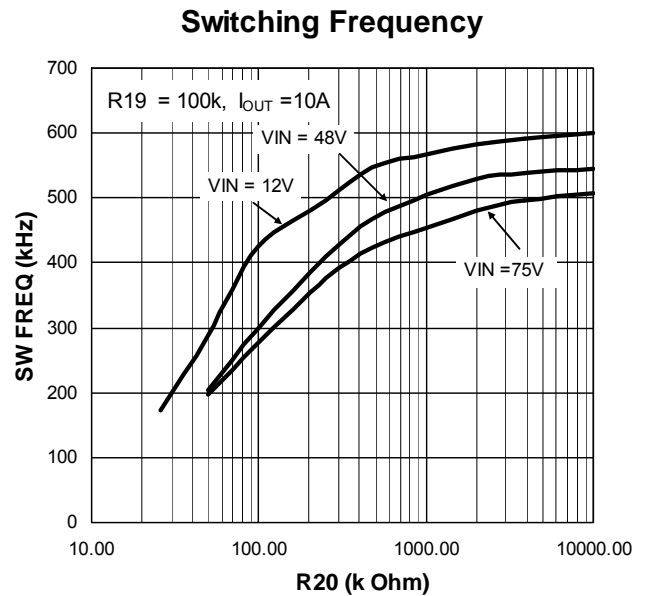
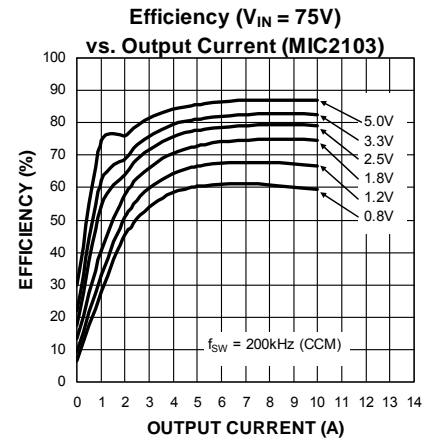
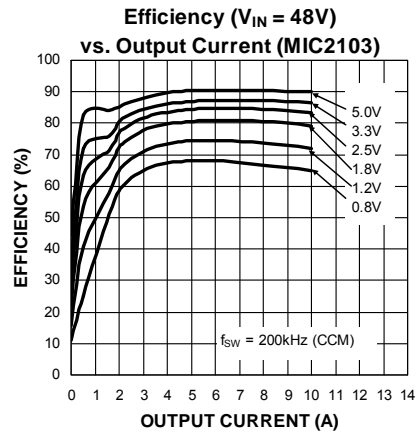
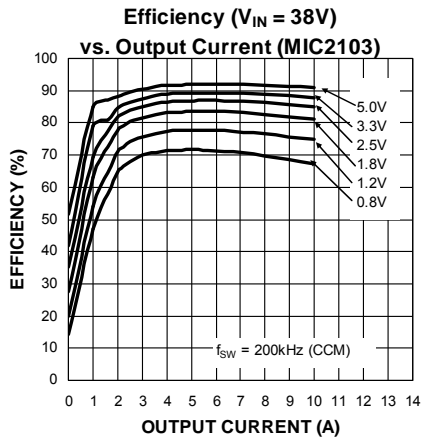
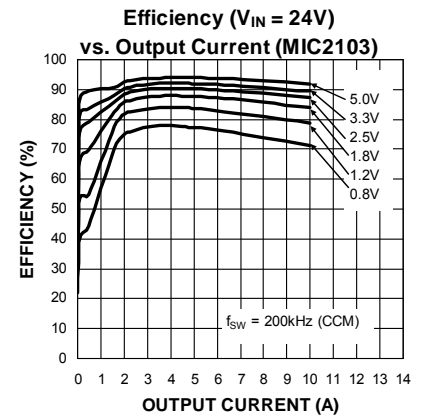
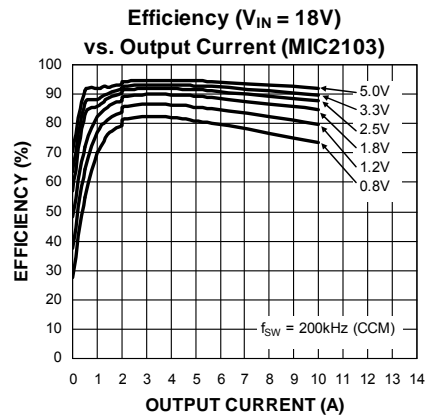
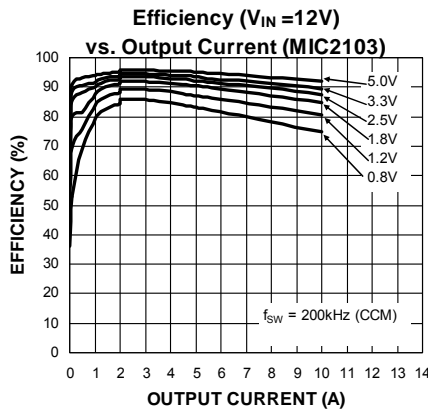
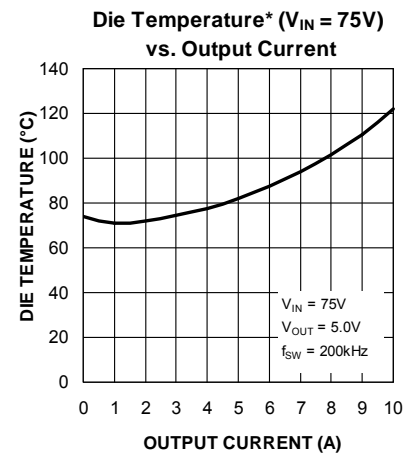
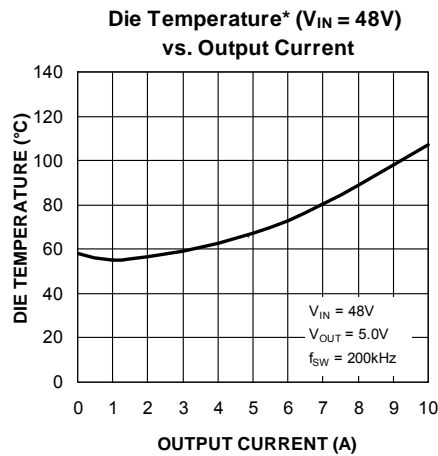
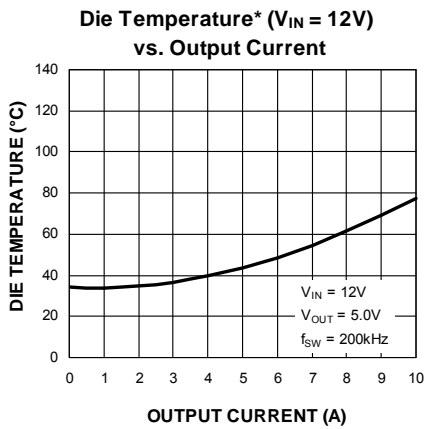
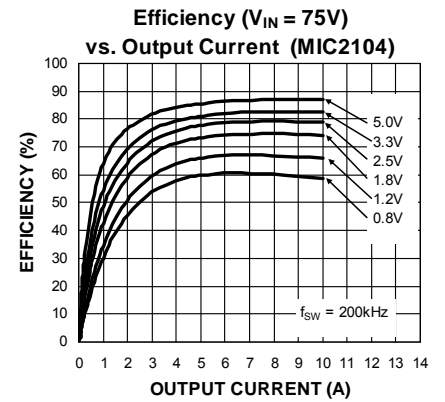
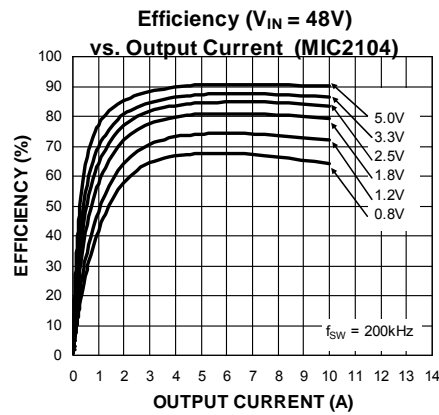
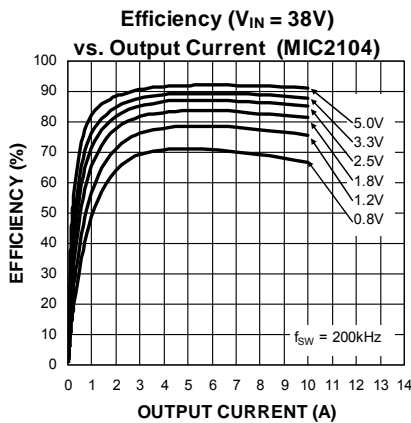
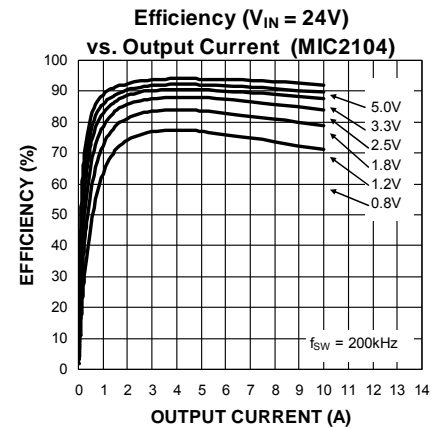
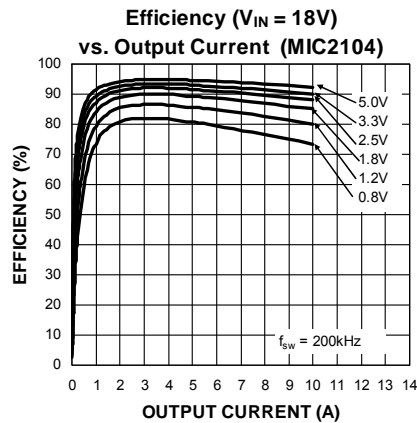
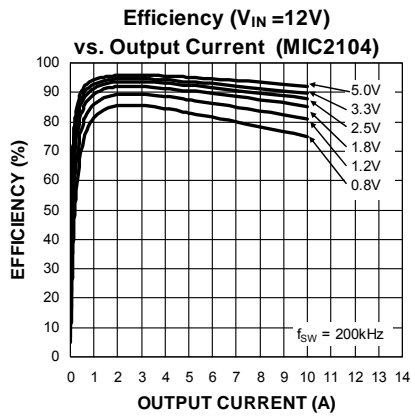

Figure 3. Switching Frequency vs. R20

MIC2103/04 0.8V to 5V/10A Evaluation Board Typical Characteristics



MIC2103/04 0.8V to 5V/10A Evaluation Board Typical Characteristics (Continued)



Die Temperature* : The temperature measurement was taken at the hottest point on the MIC2103/04 case mounted on a 5 square inch 4 layer, 0.62", FR-4 PCB with 2oz. finish copper weight per layer, see Thermal Measurement section. Actual results will depend upon the size of the PCB, ambient temperature and proximity to other heat emitting components.

MIC2103/04 0.8V to 5V/10A Output Evaluation Board Schematic

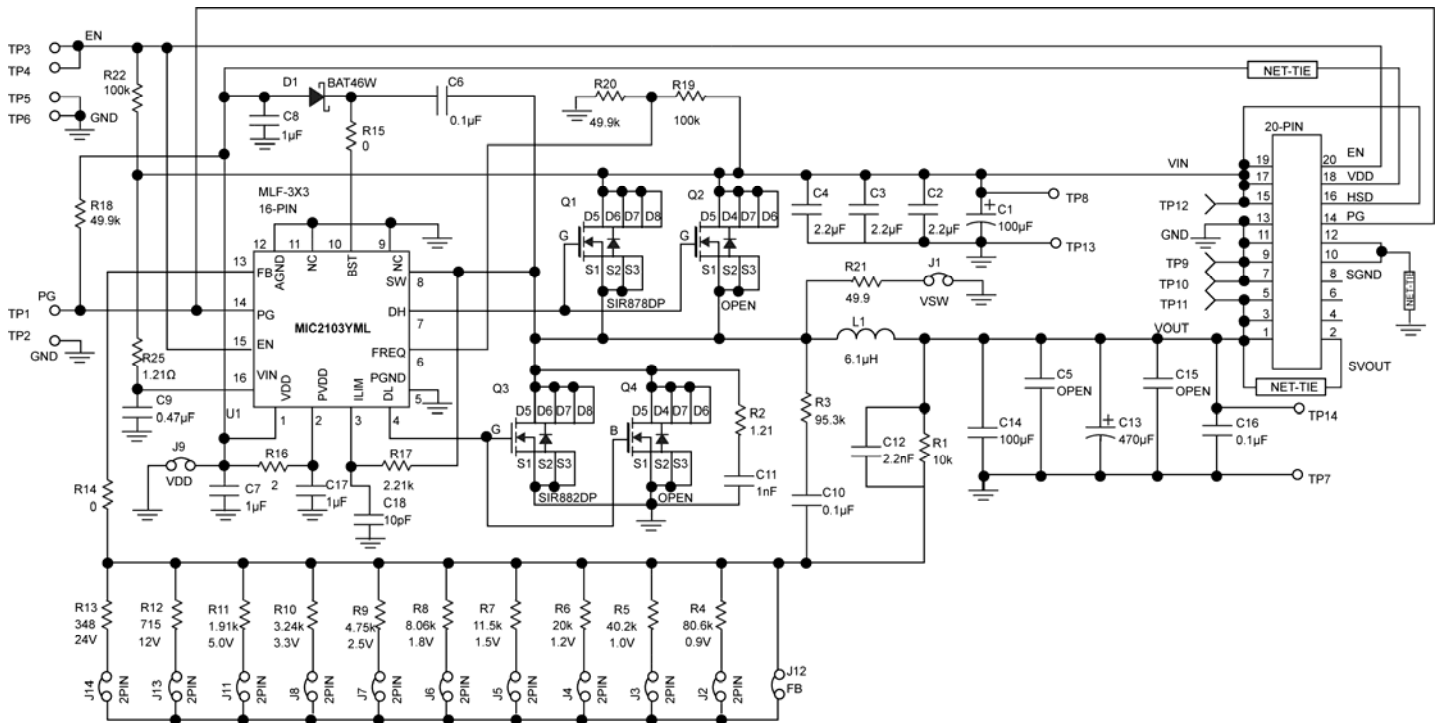

Figure 1. MIC2103/04 Evaluation Board for 0.8V to 5V/10A Output

Bill of Materials 0.8V to 5V/10A Output

Item	Part Number	Manufacturer	Description	Qty
C1	EEU-FC2A101	Panasonic ⁽¹⁾	100µF Aluminum Capacitor, 100V	1
C2, C3, C4	GRM32ER72A225K	Murata ⁽²⁾	2.2µF/100V Ceramic Capacitor, X7R, Size 1210	3
	C3225X7R2A225K	TDK ⁽³⁾		
	12101C225KAT2A	AVX ⁽⁴⁾		
C14	GRM32ER60J107ME20L	Murata	100µF/6.3V Ceramic Capacitor, X5R, Size 1210	1
	12106D107MAT2A	AVX		
	C3225X5ROJ107M	TDK		
C6, C16	GRM188R71H104KA93D	Murata	0.1µF/50V Ceramic Capacitor, X7R, Size 0603	2
	06035C104KAT2A	AVX		
	C1608X7R1H104K	TDK		
C7, C8, C17	GRM188R70J105KA01D	Murata	1µF/6.3V Ceramic Capacitor, X7R, Size 0603	3
	06036C105KAT2A	AVX		
	C1608X5R0J105K	TDK		
C9	GRM21BR72A474KA73	Murata	0.47µF/100V Ceramic Capacitor, X7R, Size 0805	1
	08051C474KAT2A	AVX		
C10	GRM188R72A104KA35D	Murata	0.1µF/100V Ceramic Capacitor, X7R, Size 0603	1
	C1608X7S2A104K	TDK	0.1µF/100V, X7S, 0603	
C11	GRM188R72A102KA01D	Murata	1nF/100V Cermeic Capacitor, X7R, Size 0603	1
	06031C102KAT2A	AVX		
	C1608X7R2A102K	TDK		
C12	GRM188R72A222KA01D	Murata	2.2nF/100V Cermeic Capacitor, X7R, Size 0603	1
	06031C222KAT2A	AVX		
	C1608X7R2A222K	TDK		
C13	6SEPC470MX	Sanyo ⁽⁵⁾	470µF/6.3V, 7m-ohms, OSCON	1
	6SEPC470M	Sanyo	470µF/6.3V, 7m-ohms, OSCON	
C15 (OPEN)	6TPB470M	Sanyo	470µF/6.3V, POSCAP	
C5 (OPEN)	GRM32ER60J107ME20L	Murata	100µF/6.3V Ceramic Capacitor, X7R, Size 1210	
C18	GCM1885C2A100JA16D	Murata	10pF, 100V, 0603, NPO	1
	06031A100JAT2A	AVX		
D1	BAT46W-TP	MCC ⁽⁶⁾	100V Small Signal Schottky Diode, SOD123	1
L1	CDEP147NP-6R1MC-95	Sumida ⁽⁷⁾	6.1µH Inductor, 14.8A RMS Current	1

Notes:

1. Panasonic: www.panasonic.com.
2. Murata: www.murata.com.
3. TDK: www.tdk.com.
4. AVX: www.avx.com
5. Sanyo: www.sanyo.com.
6. MCC.: www.mccsemi.com.
7. Sumida: www.sumida.com.

Bill of Materials 0.8V to 5V/10A Output (Continued)

Item	Part Number	Manufacturer	Description	Qty
Q1	SIR878DP	Vishay ⁽⁸⁾	MOSFET, N-CH, Power SO-8	1
Q3	SIR882DP	Vishay	MOSFET, N-CH, Power SO-8	1
Q2, Q4 (OPEN)				
R1	CRCW060310K0FKEA	Vishay Dale	10k Ω Resistor, Size 0603, 1%	1
R2, R23	CRCW08051R21FKEA	Vishay Dale	1.21 Ω Resistor, Size 0805, 5%	2
R3	CRCW060395K30FKEA	Vishay Dale	95.3k Ω Resistor, Size 0603, 1%	1
R4	CRCW060380K6FKEA	Vishay Dale	80.6k Ω Resistor, Size 0603, 1%	1
R5	CRCW060340K2FKEA	Vishay Dale	40.2k Ω Resistor, Size 0603, 1%	1
R6	CRCW060320K0FKEA	Vishay Dale	20k Ω Resistor, Size 0603, 1%	1
R7	CRCW060311K5FKEA	Vishay Dale	11.5k Ω Resistor, Size 0603, 1%	1
R8	CRCW06038K06FKEA	Vishay Dale	8.06k Ω Resistor, Size 0603, 1%	1
R9	CRCW06034K75FKEA	Vishay Dale	4.75k Ω Resistor, Size 0603, 1%	1
R10	CRCW06033K24FKEA	Vishay Dale	3.24k Ω Resistor, Size 0603, 1%	1
R11	CRCW06031K91FKEA	Vishay Dale	1.91k Ω Resistor, Size 0603, 1%	1
R12 (OPEN)	CRCW0603715R0FKEA	Vishay Dale	715 Ω Resistor, Size 0603, 1%	
R13 (OPEN)	CRCW0603348R0FKEA	Vishay Dale	348 Ω Resistor, Size 0603, 1%	
R14, R15	CRCW06030000FKEA	Vishay Dale	0 Ω Resistor, Size 0603, 5%	2
R16	CRCW08052R0FKEA	Vishay Dale	2 Ω Resistor, Size 0805, 5%	1
R17	CRCW06032K21FKEA	Vishay Dale	2.21k Ω Resistor, Size 0603, 1%	1
R18, R20	CRCW060349K9FKEA	Vishay Dale	49.9k Ω Resistor, Size 0603, 1%	2
R19, R22	CRCW0603100K0FKEA	Vishay Dale	100k Ω Resistor, Size 0603, 1%	2
R21	CRCW060349R9FKEA	Vishay Dale	49.9 Ω Resistor, Size 0603, 1%	1
U1	MIC2103YML MIC2104YML	Micrel, Inc.⁽⁹⁾	75V Synchronous Buck DC-DC Controller	1

Notes:8. Vishay: www.vishay.com.9. Micrel, Inc.: www.micrel.com.

Evaluation Board PCB Layout

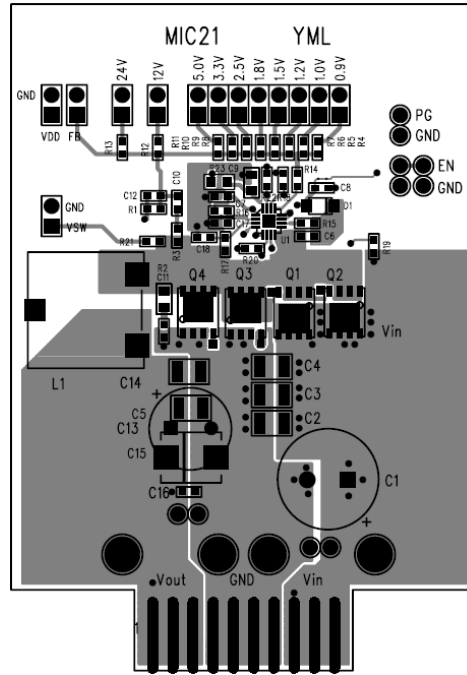

MIC2103/04 Evaluation Board – Copper Layer 1 (Top)

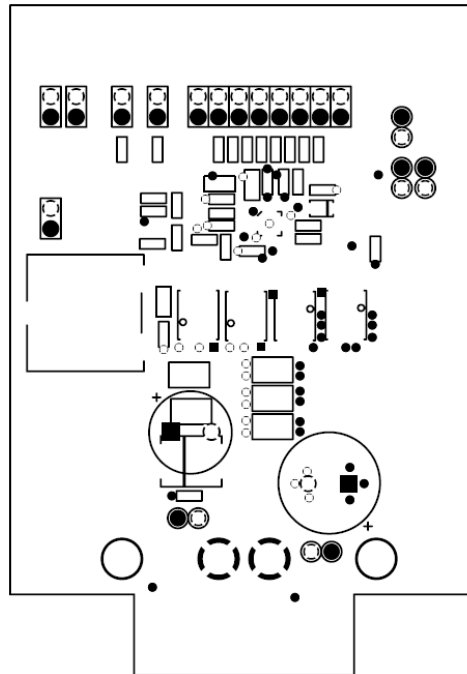

MIC2103/04 Evaluation Board – Copper Layer 2 (Mid-Layer 1)

Evaluation Board PCB Layout (Continued)

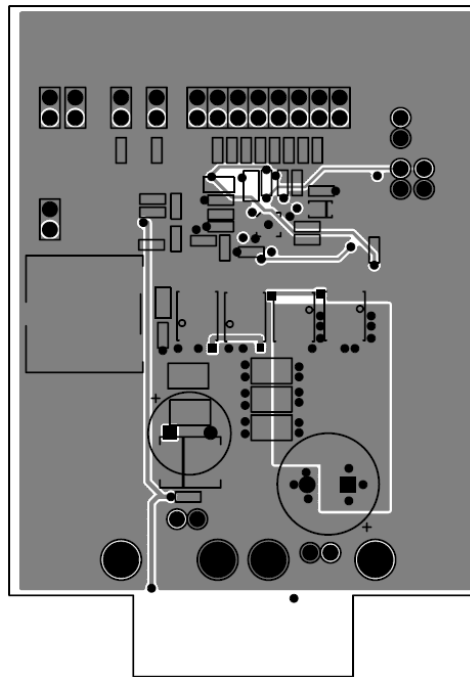

MIC2103/04 Evaluation Board – Copper Layer 3 (Mid-Layer 2)

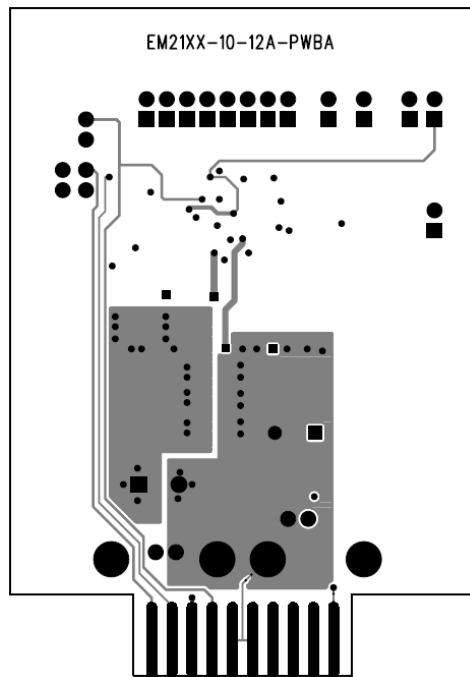

MIC2103/04 Evaluation Board – Copper Layer 4 (Bottom)

MICREL, INC. 2180 FORTUNE DRIVE SAN JOSE, CA 95131 USA
TEL +1 (408) 944-0800 FAX +1 (408) 474-1000 WEB <http://www.micrel.com>

Micrel makes no representations or warranties with respect to the accuracy or completeness of the information furnished in this data sheet. This information is not intended as a warranty and Micrel does not assume responsibility for its use. Micrel reserves the right to change circuitry, specifications and descriptions at any time without notice. No license, whether express, implied, arising by estoppel or otherwise, to any intellectual property rights is granted by this document. Except as provided in Micrel's terms and conditions of sale for such products, Micrel assumes no liability whatsoever, and Micrel disclaims any express or implied warranty relating to the sale and/or use of Micrel products including liability or warranties relating to fitness for a particular purpose, merchantability, or infringement of any patent, copyright or other intellectual property right.

Micrel Products are not designed or authorized for use as components in life support appliances, devices or systems where malfunction of a product can reasonably be expected to result in personal injury. Life support devices or systems are devices or systems that (a) are intended for surgical implant into the body or (b) support or sustain life, and whose failure to perform can be reasonably expected to result in a significant injury to the user. A Purchaser's use or sale of Micrel Products for use in life support appliances, devices or systems is a Purchaser's own risk and Purchaser agrees to fully indemnify Micrel for any damages resulting from such use or sale.