

## High efficiency rectifier

Datasheet - production data

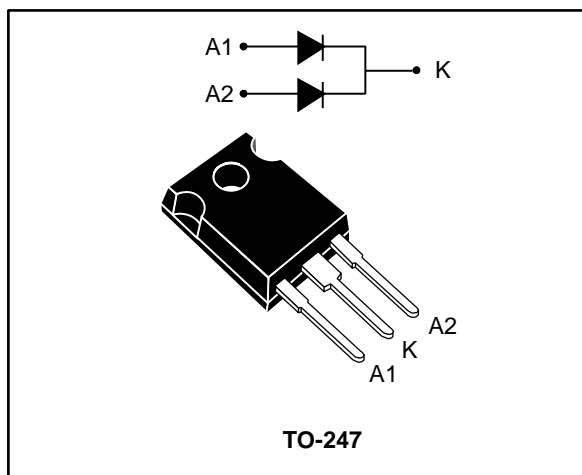

### Description

The STTH60W03C uses ST 300 V technology. It is especially suited to be used for DC/DC and DC/AC converters in secondary stage of MIG/MMA/TIG welding machine. Housed in ST's TO-247, this device offers high power integration for all welding machines and industrial applications.

**Table 1: Device summary**

Symbol	Value
$I_{F(AV)}$	2 x 30 A
$V_{RRM}$	300 V
$T_j$	175 °C
$V_F$ (typ.)	0.94 V
$t_{rr}$ (typ.)	25 ns

### Features

- Ultrafast switching
- Low reverse current
- Low thermal resistance
- Reduced switching losses
- ECOPACK<sup>®</sup>2 compliant component

# 1 Characteristics

**Table 2: Absolute ratings (limiting values, per diode, limiting values at 25°C, unless otherwise specified)**

Symbol	Parameter			Value	Unit
V <sub>RRM</sub>	Repetitive peak reverse voltage			300	V
I <sub>F(RMS)</sub>	Forward rms current			50	A
I <sub>F(AV)</sub>	Average forward current $\delta = 0.5$ , square wave	T <sub>c</sub> = 110 °C	Per diode	30	A
		T <sub>c</sub> = 95 °C	Per device	60	A
I <sub>FSM</sub>	Surge non repetitive forward current	t <sub>p</sub> = 10 ms sinusoidal		280	A
T <sub>stg</sub>	Storage temperature range			-65 to +175	°C
T <sub>j</sub>	Maximum operating junction temperature range			+175	°C

**Table 3: Thermal parameters**

Symbol	Parameter		Max. value	Unit
R <sub>th(j-c)</sub>	Junction to case	Per diode	1.5	°C/W
		Total	0.9	°C/W
R <sub>th(c)</sub>	Coupling		0.3	°C/W

When the diodes 1 and 2 are used simultaneously:

$$\Delta T_j (\text{diode1}) = P_{(\text{diode1})} \times R_{th(j-c)} (\text{per diode}) + P_{(\text{diode2})} \times R_{th(c)}$$

**Table 4: Static electrical characteristics (per diode)**

Symbol	Parameter	Test conditions		Min.	Typ.	Max.	Unit
I <sub>R</sub> <sup>(1)</sup>	Reverse leakage current	T <sub>j</sub> = 25 °C	V <sub>R</sub> = V <sub>RRM</sub>	-		20	μA
		T <sub>j</sub> = 125 °C		-	20	200	
V <sub>F</sub> <sup>(2)</sup>	Forward voltage drop	T <sub>j</sub> = 25 °C	I <sub>F</sub> = 30 A	-		1.45	V
		T <sub>j</sub> = 150 °C		-	0.94	1.15	
		T <sub>j</sub> = 25 °C	I <sub>F</sub> = 60 A	-		1.7	
		T <sub>j</sub> = 150 °C		-	1.18	1.45	

**Notes:**

(1)Pulse test: t<sub>p</sub> = 5 ms,  $\delta < 2\%$

(2)Pulse test: t<sub>p</sub> = 380 μs,  $\delta < 2\%$

To evaluate the conduction losses, use the following equation:

$$P = 0.85 \times I_{F(AV)} + 0.010 \times I_{F(RMS)}^2$$

Table 5: Dynamic electrical characteristics (per diode)

Symbol	Parameters	Test conditions		Min.	Typ.	Max.	Unit
$I_{RM}$	Reverse recovery current	$T_j = 125\text{ °C}$	$I_F = 30\text{ A}$ , $V_R = 200\text{ V}$ , $di_F/dt = -200\text{ A}/\mu\text{s}$	-	7	9	A
$Q_{RR}$	Reverse recovery charge	$T_j = 125\text{ °C}$	$I_F = 30\text{ A}$ , $V_R = 200\text{ V}$ , $di_F/dt = -200\text{ A}/\mu\text{s}$	-	180		nC
$S_{factor}$	Softness factor	$T_j = 125\text{ °C}$	$I_F = 30\text{ A}$ , $V_R = 200\text{ V}$ , $di_F/dt = -200\text{ A}/\mu\text{s}$	-	0.3		
$t_{rr}$	Reverse recovery time	$T_j = 25\text{ °C}$	$I_F = 1\text{ A}$ , $di_F/dt = -100\text{ A}/\mu\text{s}$ , $V_R = 30\text{ V}$	-	25	35	ns
$t_{fr}$	Forward recovery time	$T_j = 25\text{ °C}$	$I_F = 30\text{ A}$ , $di_F/dt = 200\text{ A}/\mu\text{s}$ , $V_{FR} = 1.5\text{ V}$	-		180	ns
$V_{FP}$	Forward recovery voltage			-	2.0	3.0	V

# 1.1 Characteristics (curves)

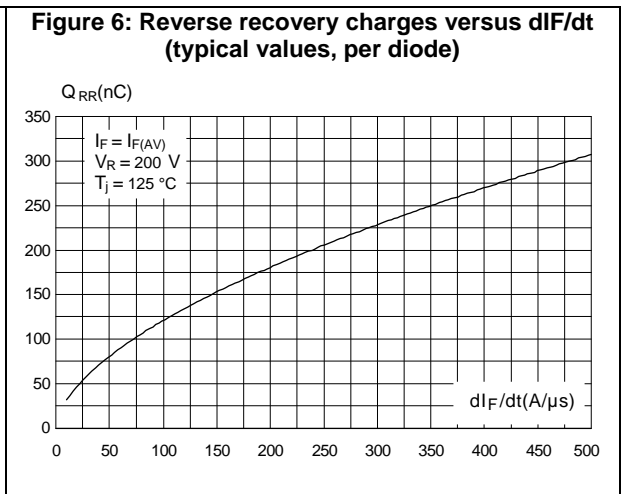
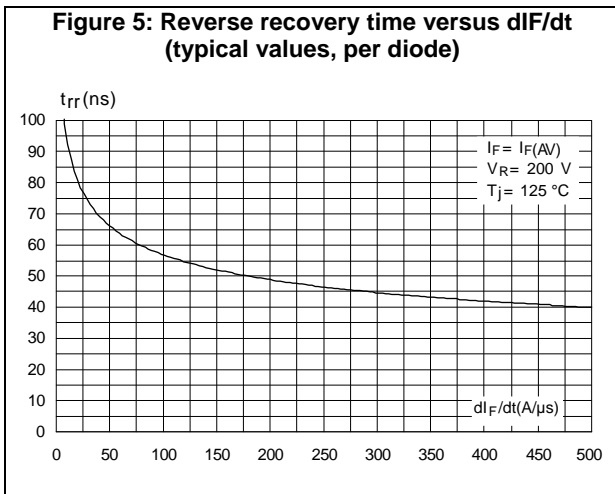
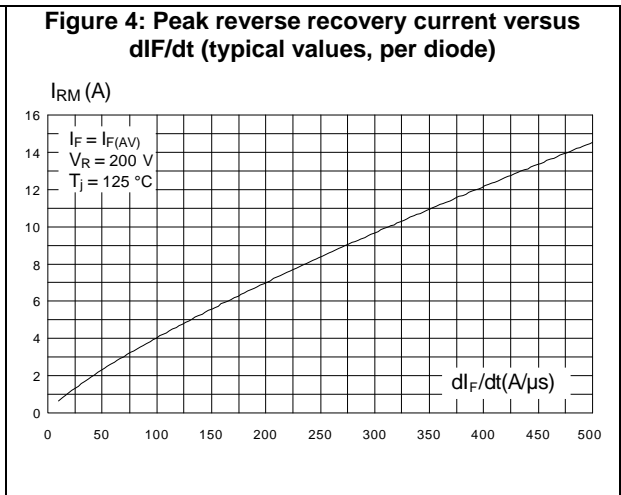
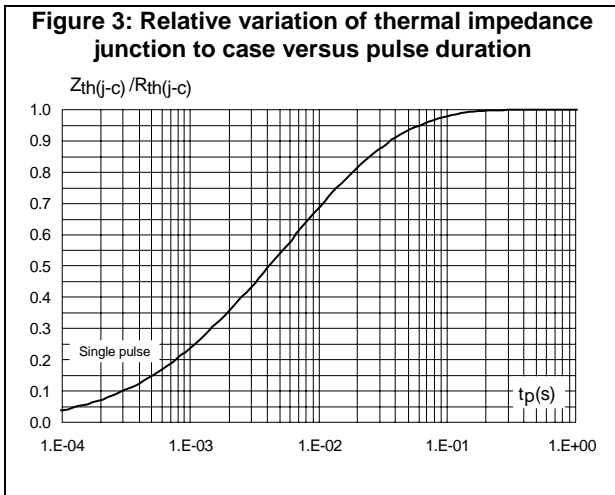
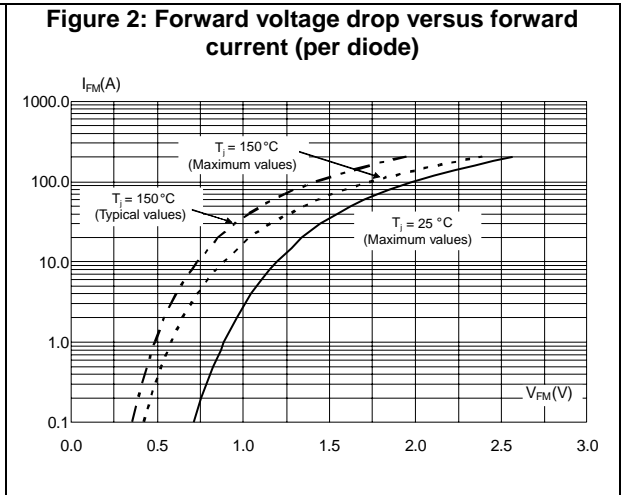
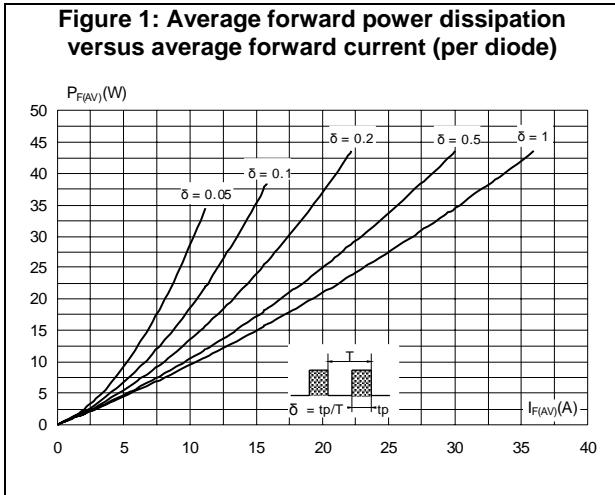

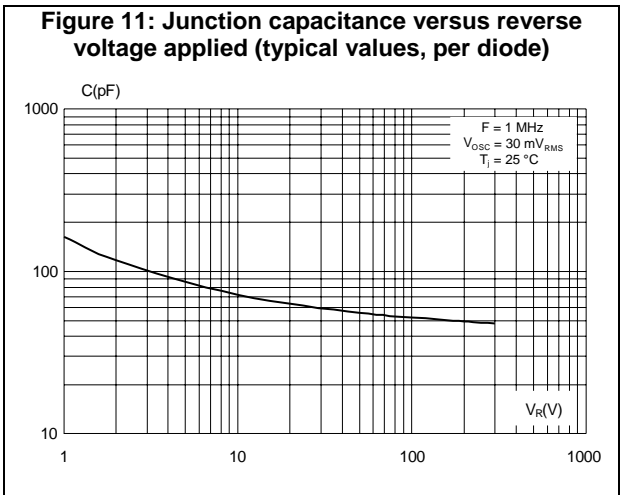
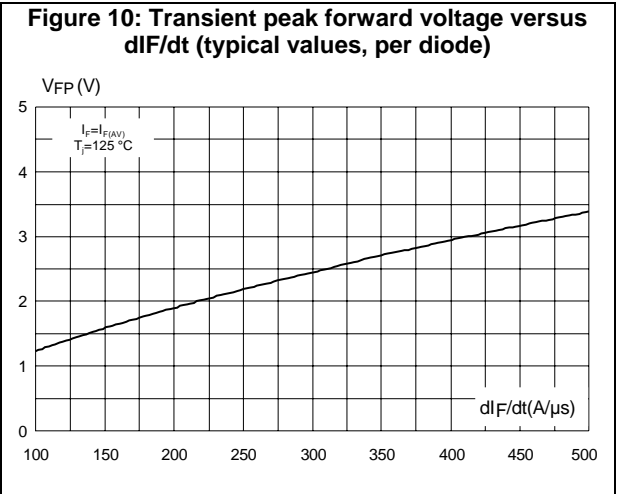
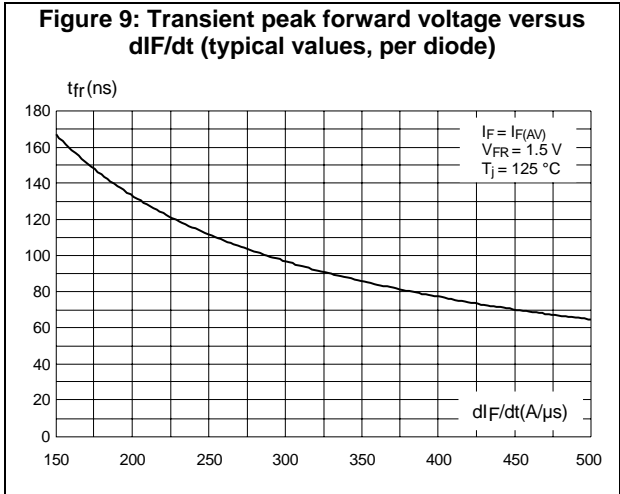
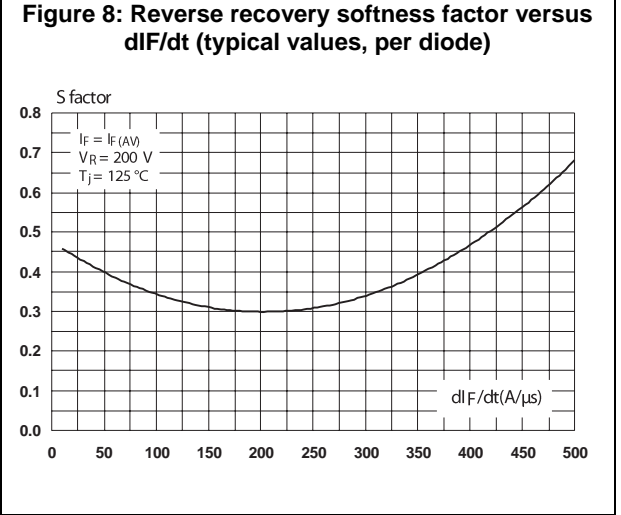
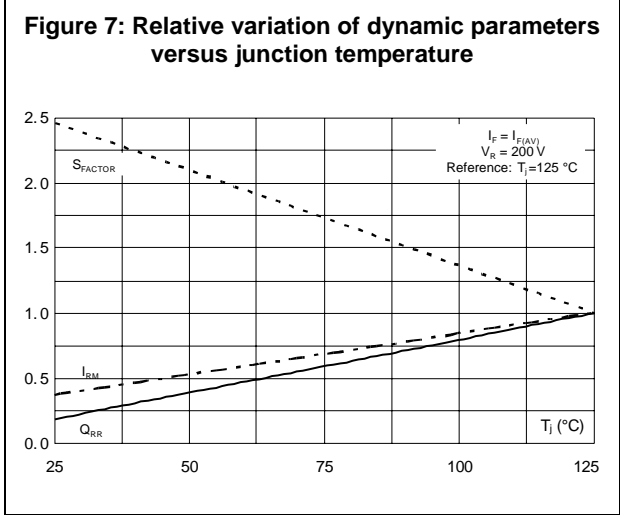

## 2 Package information

In order to meet environmental requirements, ST offers these devices in different grades of ECOPACK® packages, depending on their level of environmental compliance. ECOPACK® specifications, grade definitions and product status are available at: [www.st.com](http://www.st.com). ECOPACK® is an ST trademark.

- Epoxy meets UL94, V0
- Cooling method: by conduction (C)
- Recommended torque value: 0.8 N·m (TO-247)
- Maximum torque value: 1.0 N·m (TO-247)

### 2.1 TO-247 with Inches package information

Figure 12: TO-247 package outline

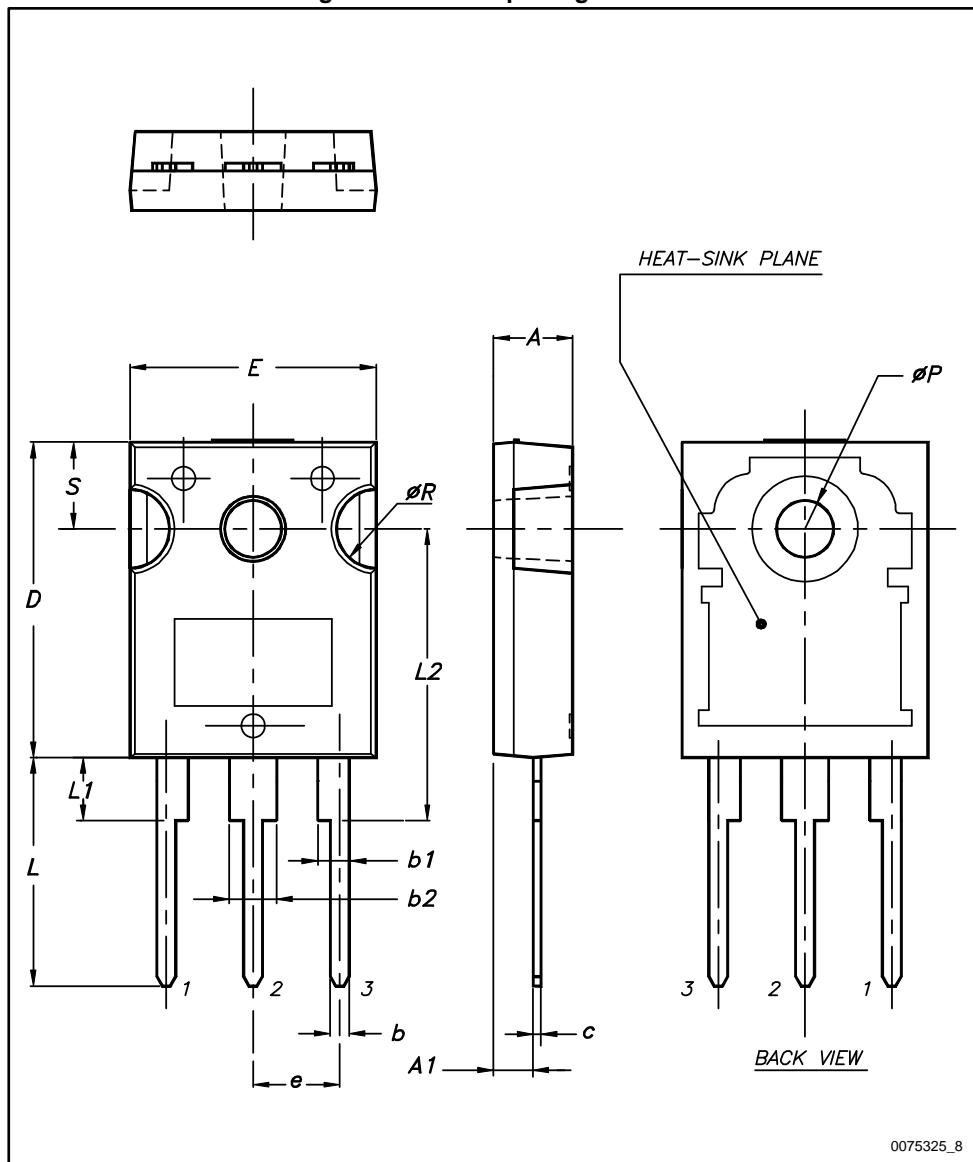

Table 6: TO-247 package mechanical data

Ref.	Dimensions					
	Millimeters			Inches		
	Min.	Typ.	Max.	Min.	Typ.	Max.
A	4.85		5.15	0.191		0.203
A1	2.20		2.60	0.086		0.102
b	1.00		1.40	0.039		0.055
b1	2.00		2.40	0.078		0.094
b2	3.00		3.40	0.118		0.133
c	0.40		0.80	0.015		0.031
D <sup>(1)</sup>	19.85		20.15	0.781		0.793
E	15.45		15.75	0.608		0.620
e	5.30	5.45	5.60	0.209	0.215	0.220
L	14.20		14.80	0.559		0.582
L1	3.70		4.30	0.145		0.169
L2		18.50			0.728	
ØP <sup>(2)</sup>	3.55		3.65	0.139		0.143
ØR	4.50		5.50	0.177		0.217
S	5.30	5.50	5.70	0.209	0.216	0.224

**Notes:**

<sup>(1)</sup>Dimension D plus gate protusion does not exceed 20.5 mm

<sup>(2)</sup>Resin thickness around the mounting hole is not less than 0.9 mm.

### 3 Ordering information

Table 7: Ordering information

Order code	Marking	Package	Weight	Base qty.	Delivery mode
STTH60W03CW	STTH60W03CW	TO-247	4.43 g	50	Tube

### 4 Revision history

Table 8: Document revision history

Date	Revision	Changes
07-Sep-2004	1	First issue.
08-Feb-2018	2	Updated Description and package information.



**IMPORTANT NOTICE – PLEASE READ CAREFULLY**

STMicroelectronics NV and its subsidiaries (“ST”) reserve the right to make changes, corrections, enhancements, modifications, and improvements to ST products and/or to this document at any time without notice. Purchasers should obtain the latest relevant information on ST products before placing orders. ST products are sold pursuant to ST’s terms and conditions of sale in place at the time of order acknowledgement.

Purchasers are solely responsible for the choice, selection, and use of ST products and ST assumes no liability for application assistance or the design of Purchasers’ products.

No license, express or implied, to any intellectual property right is granted by ST herein.

Resale of ST products with provisions different from the information set forth herein shall void any warranty granted by ST for such product.

ST and the ST logo are trademarks of ST. All other product or service names are the property of their respective owners.

Information in this document supersedes and replaces information previously supplied in any prior versions of this document.

© 2018 STMicroelectronics – All rights reserved