

# BC846ALT1 Series

BC846, BC847 and BC848 are Preferred Devices

## General Purpose Transistors

### NPN Silicon

#### Features

- Pb-Free Packages are Available
- Moisture Sensitivity Level: 1
- ESD Rating – Human Body Model: >4000 V  
– Machine Model: >400 V

#### MAXIMUM RATINGS

Rating	Symbol	Value	Unit
Collector-Emitter Voltage BC846 BC847, BC850 BC848, BC849	$V_{CE0}$	65 45 30	Vdc
Collector-Base Voltage BC846 BC847, BC850 BC848, BC849	$V_{CBO}$	80 50 30	Vdc
Emitter-Base Voltage BC846 BC847, BC850 BC848, BC849	$V_{EBO}$	6.0 6.0 5.0	Vdc
Collector Current – Continuous	$I_C$	100	mAdc

Maximum ratings are those values beyond which device damage can occur. Maximum ratings applied to the device are individual stress limit values (not normal operating conditions) and are not valid simultaneously. If these limits are exceeded, device functional operation is not implied, damage may occur and reliability may be affected.

#### THERMAL CHARACTERISTICS

Characteristic	Symbol	Max	Unit
Total Device Dissipation FR-5 Board, (Note 1) $T_A = 25^\circ\text{C}$ Derate above $25^\circ\text{C}$	$P_D$	225 1.8	mW mW/°C
Thermal Resistance, Junction-to-Ambient (Note 1)	$R_{\theta JA}$	556	°C/W
Total Device Dissipation Alumina Substrate (Note 2) $T_A = 25^\circ\text{C}$ Derate above $25^\circ\text{C}$	$P_D$	300 2.4	mW mW/°C
Thermal Resistance, Junction-to-Ambient (Note 2)	$R_{\theta JA}$	417	°C/W
Junction and Storage Temperature Range	$T_J, T_{stg}$	-55 to +150	°C

1. FR-5 =  $1.0 \times 0.75 \times 0.062$  in.
2. Alumina =  $0.4 \times 0.3 \times 0.024$  in 99.5% alumina.



ON Semiconductor®

<http://onsemi.com>

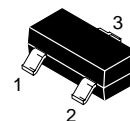
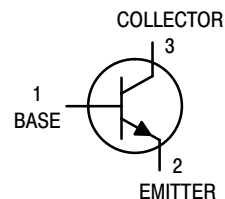

SOT-23  
CASE 318  
STYLE 6

#### MARKING DIAGRAM

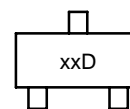

xx = Specific Device Code  
D = Date Code

#### ORDERING INFORMATION

See detailed ordering and shipping information in the package dimensions section on page 5 of this data sheet.

Preferred devices are recommended choices for future use and best overall value.

## BC846ALT1 Series

### ELECTRICAL CHARACTERISTICS ( $T_A = 25^\circ\text{C}$ unless otherwise noted)

Characteristic	Symbol	Min	Typ	Max	Unit	
<b>OFF CHARACTERISTICS</b>						
Collector–Emitter Breakdown Voltage ( $I_C = 10\text{ mA}$ )	BC846A,B BC847A,B,C, BC850B,C BC848A,B,C, BC849B,C	$V_{(BR)CEO}$	65 45 30	– – –	– – –	V
Collector–Emitter Breakdown Voltage ( $I_C = 10\text{ }\mu\text{A}$ , $V_{EB} = 0$ )	BC846A,B BC847A,B,C BC850B,C BC848A,B,C, BC849B,C	$V_{(BR)CES}$	80 50 30	– – –	– – –	V
Collector–Base Breakdown Voltage ( $I_C = 10\text{ }\mu\text{A}$ )	BC846A,B BC847A,B,C, BC850B,C BC848A,B,C, BC849B,C	$V_{(BR)CBO}$	80 50 30	– – –	– – –	V
Emitter–Base Breakdown Voltage ( $I_E = 1.0\text{ }\mu\text{A}$ )	BC846A,B BC847A,B,C, BC850B,C BC848A,B,C, BC849B,C	$V_{(BR)EBO}$	6.0 6.0 5.0	– – –	– – –	V
Collector Cutoff Current ( $V_{CB} = 30\text{ V}$ ) ( $V_{CB} = 30\text{ V}$ , $T_A = 150^\circ\text{C}$ )		$I_{CBO}$	– –	– –	15 5.0	nA $\mu\text{A}$
<b>ON CHARACTERISTICS</b>						
DC Current Gain ( $I_C = 10\text{ }\mu\text{A}$ , $V_{CE} = 5.0\text{ V}$ )	BC846A, BC847A, BC848A BC846B, BC847B, BC848B BC847C, BC848C	$h_{FE}$	– – –	90 150 270	– – –	–
( $I_C = 2.0\text{ mA}$ , $V_{CE} = 5.0\text{ V}$ )	BC846A, BC847A, BC848A BC846B, BC847B, BC848B, BC849B, BC850B BC847C, BC848C, BC849C, BC850C		110 200 420	180 290 520	220 450 800	
Collector–Emitter Saturation Voltage ( $I_C = 10\text{ mA}$ , $I_B = 0.5\text{ mA}$ ) ( $I_C = 100\text{ mA}$ , $I_B = 5.0\text{ mA}$ )		$V_{CE(sat)}$	– –	– –	0.25 0.6	V
Base–Emitter Saturation Voltage ( $I_C = 10\text{ mA}$ , $I_B = 0.5\text{ mA}$ ) ( $I_C = 100\text{ mA}$ , $I_B = 5.0\text{ mA}$ )		$V_{BE(sat)}$	– –	0.7 0.9	– –	V
Base–Emitter Voltage ( $I_C = 2.0\text{ mA}$ , $V_{CE} = 5.0\text{ V}$ ) ( $I_C = 10\text{ mA}$ , $V_{CE} = 5.0\text{ V}$ )		$V_{BE(on)}$	580 –	660 –	700 770	mV
<b>SMALL–SIGNAL CHARACTERISTICS</b>						
Current–Gain – Bandwidth Product ( $I_C = 10\text{ mA}$ , $V_{CE} = 5.0\text{ Vdc}$ , $f = 100\text{ MHz}$ )		$f_T$	100	–	–	MHz
Output Capacitance ( $V_{CB} = 10\text{ V}$ , $f = 1.0\text{ MHz}$ )		$C_{obo}$	–	–	4.5	pF
Noise Figure ( $I_C = 0.2\text{ mA}$ , $V_{CE} = 5.0\text{ Vdc}$ , $R_S = 2.0\text{ k}\Omega$ , $f = 1.0\text{ kHz}$ , $BW = 200\text{ Hz}$ )	BC846A,B, BC847A,B,C, BC848A,B,C BC849B,C, BC850B,C	NF	– –	– –	10 4.0	dB

# BC846ALT1 Series

## BC847, BC848, BC849, BC850

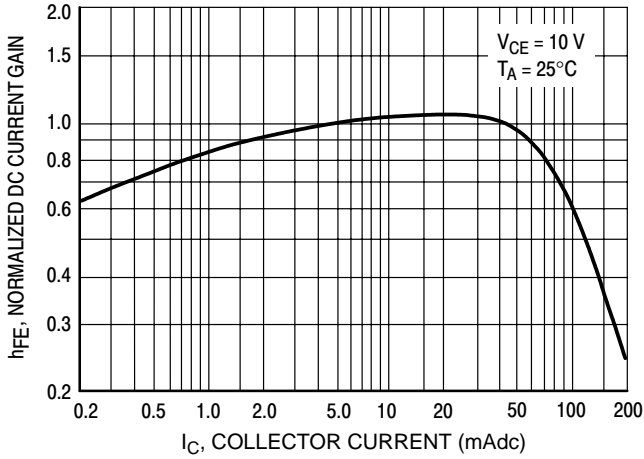

Figure 1. Normalized DC Current Gain

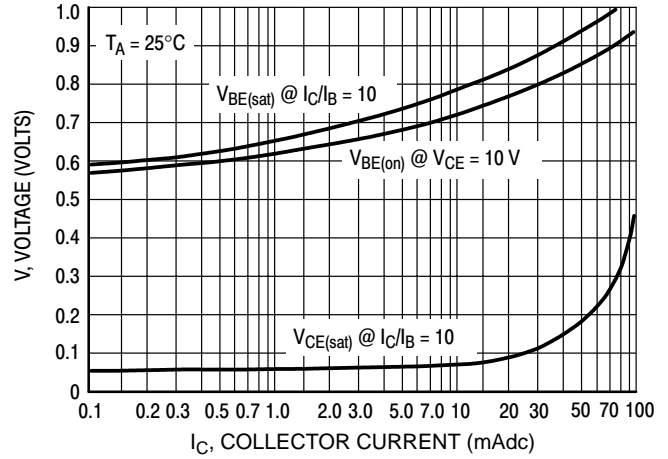

Figure 2. "Saturation" and "On" Voltages

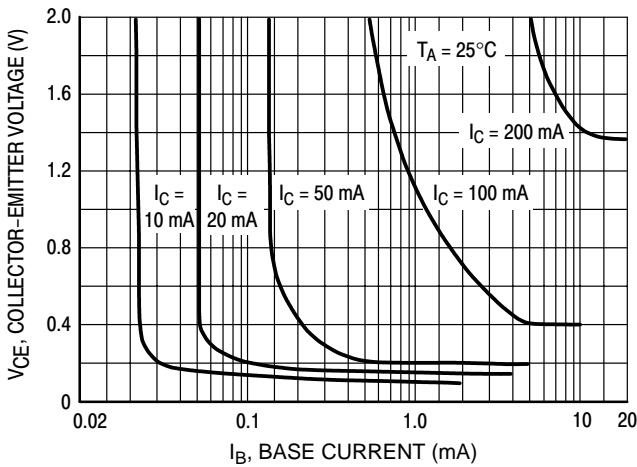

Figure 3. Collector Saturation Region

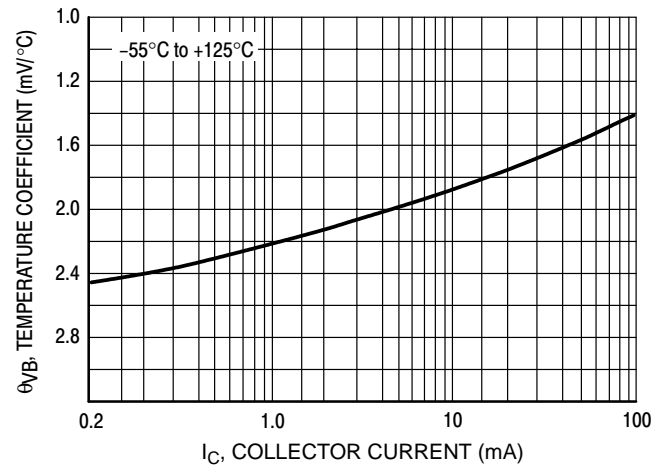

Figure 4. Base-Emitter Temperature Coefficient

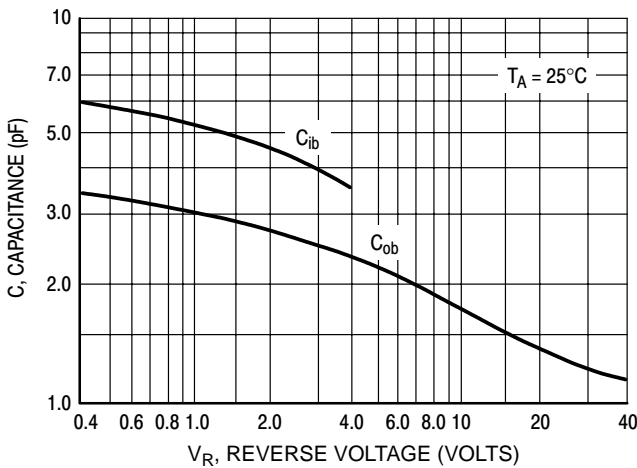

Figure 5. Capacitances

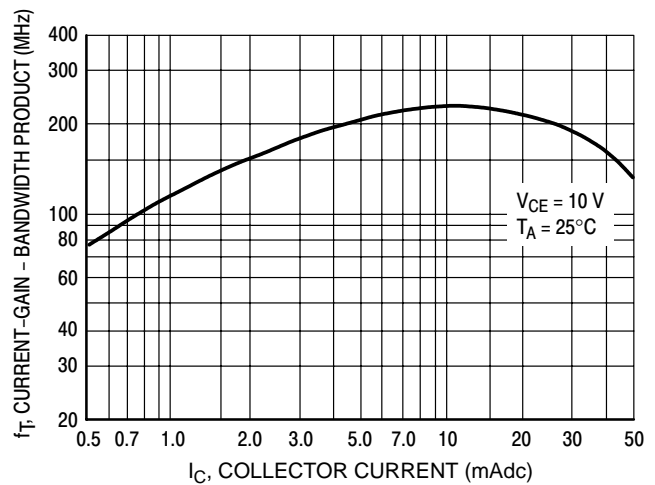

Figure 6. Current-Gain - Bandwidth Product

# BC846ALT1 Series

## BC846

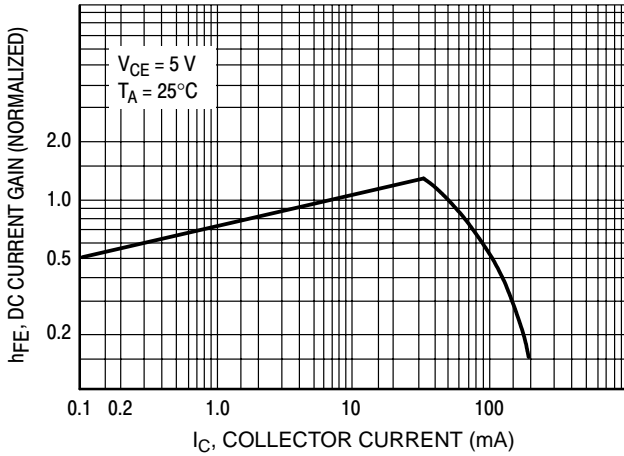

Figure 7. DC Current Gain

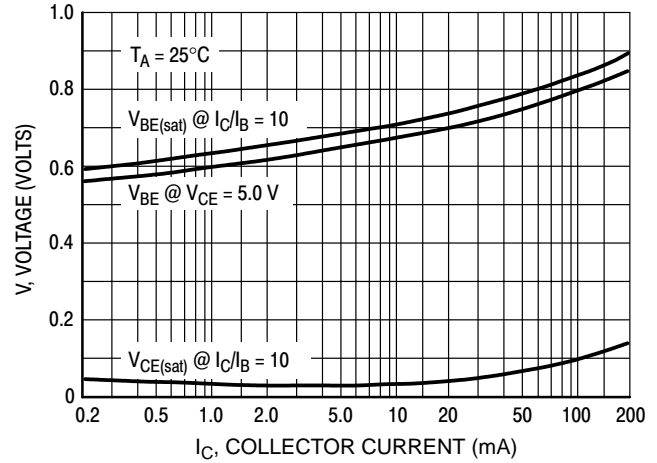

Figure 8. "On" Voltage

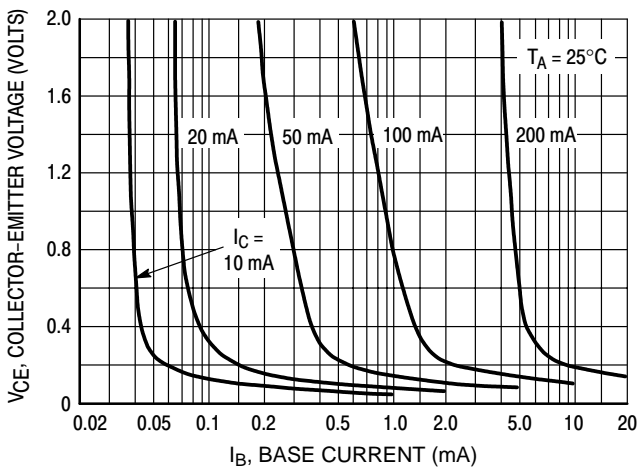

Figure 9. Collector Saturation Region

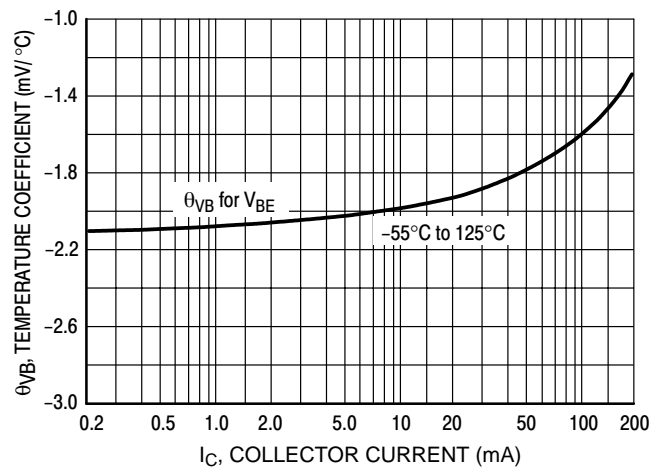

Figure 10. Base-Emitter Temperature Coefficient

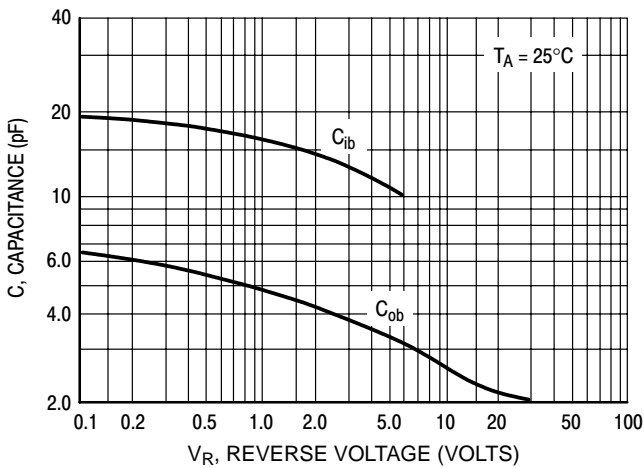

Figure 11. Capacitance

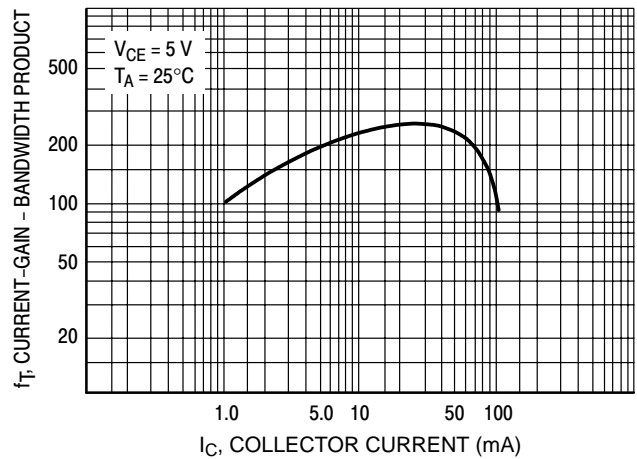

Figure 12. Current-Gain - Bandwidth Product

## BC846ALT1 Series

### ORDERING INFORMATION

Device	Marking	Package	Shipping†
BC846ALT1	1A	SOT-23	3,000 / Tape & Reel
BC846ALT3	1A	SOT-23	10,000 / Tape & Reel
BC846BLT1	1B	SOT-23	3,000 / Tape & Reel
BC846BLT3	1B	SOT-23	10,000 / Tape & Reel
BC847ALT1	1E	SOT-23	3,000 / Tape & Reel
BC847ALT1G	1E	SOT-23 (Pb-Free)	
BC847BLT1	1F	SOT-23	3,000 / Tape & Reel
BC847CLT1	1G	SOT-23	3,000 / Tape & Reel
BC847CLT1G	1G	SOT-23 (Pb-Free)	
BC847CLT3	1G	SOT-23	10,000 / Tape & Reel
BC847CLT3G	1G	SOT-23 (Pb-Free)	
BC848ALT1	1J	SOT-23	3,000 / Tape & Reel
BC848ALT1G	1J	SOT-23 (Pb-Free)	3,000 / Tape & Reel
BC848BLT1	1K	SOT-23	3,000 / Tape & Reel
BC848BLT3	1K	SOT-23	10,000 / Tape & Reel
BC848CLT1	1L	SOT-23	3,000 / Tape & Reel
BC848CLT1G	1L	SOT-23 (Pb-Free)	
BC849BLT1	2B	SOT-23	3,000 / Tape & Reel
BC849BLT3	2B	SOT-23	10,000 / Tape & Reel
BC849CLT1	2C	SOT-23	3,000 / Tape & Reel
BC849CLT1G	2C	SOT-23 (Pb-Free)	3,000 / Tape & Reel
BC850BLT1	2F	SOT-23	3,000 / Tape & Reel
BC850CLT1	2G	SOT-23	3,000 / Tape & Reel
BC850CLT1G	2G	SOT-23 (Pb-Free)	

†For information on tape and reel specifications, including part orientation and tape sizes, please refer to our Tape and Reel Packaging Specifications Brochure, BRD8011/D.

# BC846ALT1 Series

## PACKAGE DIMENSIONS

SOT-23 (TO-236)  
CASE 318-09  
ISSUE AI

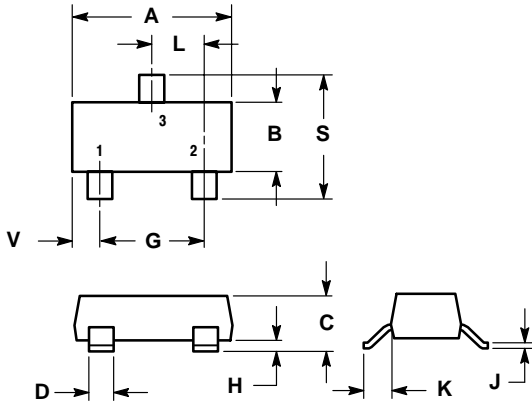

NOTES:

1. DIMENSIONING AND TOLERANCING PER ANSI Y14.5M, 1982.
2. CONTROLLING DIMENSION: INCH.
3. MAXIMUM LEAD THICKNESS INCLUDES LEAD FINISH THICKNESS. MINIMUM LEAD THICKNESS IS THE MINIMUM THICKNESS OF BASE MATERIAL.
4. 318-01, -02, AND -06 OBSOLETE, NEW STANDARD 318-09.

DIM	INCHES		MILLIMETERS	
	MIN	MAX	MIN	MAX
A	0.1102	0.1197	2.80	3.04
B	0.0472	0.0551	1.20	1.40
C	0.0385	0.0498	0.99	1.26
D	0.0140	0.0200	0.36	0.50
G	0.0670	0.0826	1.70	2.10
H	0.0040	0.0098	0.10	0.25
J	0.0034	0.0070	0.085	0.177
K	0.0180	0.0236	0.45	0.60
L	0.0350	0.0401	0.89	1.02
S	0.0830	0.0984	2.10	2.50
V	0.0177	0.0236	0.45	0.60

STYLE 6:

1. BASE
2. EMITTER
3. COLLECTOR

### SOLDERING FOOTPRINT\*

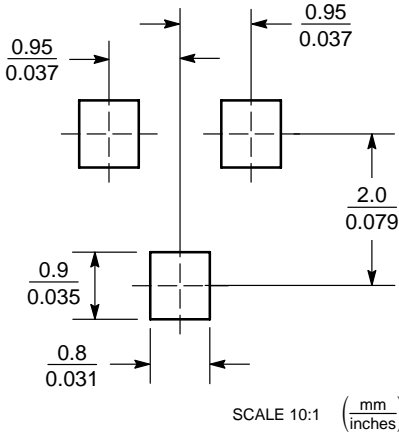

\*For additional information on our Pb-Free strategy and soldering details, please download the ON Semiconductor Soldering and Mounting Techniques Reference Manual, SOLDERRM/D.

ON Semiconductor and  are registered trademarks of Semiconductor Components Industries, LLC (SCILLC). SCILLC reserves the right to make changes without further notice to any products herein. SCILLC makes no warranty, representation or guarantee regarding the suitability of its products for any particular purpose, nor does SCILLC assume any liability arising out of the application or use of any product or circuit, and specifically disclaims any and all liability, including without limitation special, consequential or incidental damages. "Typical" parameters which may be provided in SCILLC data sheets and/or specifications can and do vary in different applications and actual performance may vary over time. All operating parameters, including "Typicals" must be validated for each customer application by customer's technical experts. SCILLC does not convey any license under its patent rights nor the rights of others. SCILLC products are not designed, intended, or authorized for use as components in systems intended for surgical implant into the body, or other applications intended to support or sustain life, or for any other application in which the failure of the SCILLC product could create a situation where personal injury or death may occur. Should Buyer purchase or use SCILLC products for any such unintended or unauthorized application, Buyer shall indemnify and hold SCILLC and its officers, employees, subsidiaries, affiliates, and distributors harmless against all claims, costs, damages, and expenses, and reasonable attorney fees arising out of, directly or indirectly, any claim of personal injury or death associated with such unintended or unauthorized use, even if such claim alleges that SCILLC was negligent regarding the design or manufacture of the part. SCILLC is an Equal Opportunity/Affirmative Action Employer. This literature is subject to all applicable copyright laws and is not for resale in any manner.

### PUBLICATION ORDERING INFORMATION

**LITERATURE FULFILLMENT:**  
Literature Distribution Center for ON Semiconductor  
P.O. Box 61312, Phoenix, Arizona 85082-1312 USA  
**Phone:** 480-829-7710 or 800-344-3860 Toll Free USA/Canada  
**Fax:** 480-829-7709 or 800-344-3867 Toll Free USA/Canada  
**Email:** orderlit@onsemi.com

**N. American Technical Support:** 800-282-9855 Toll Free USA/Canada

**Japan:** ON Semiconductor, Japan Customer Focus Center  
2-9-1 Kamimeguro, Meguro-ku, Tokyo, Japan 153-0051  
**Phone:** 81-3-5773-3850

**ON Semiconductor Website:** <http://onsemi.com>

**Order Literature:** <http://www.onsemi.com/litorder>

For additional information, please contact your local Sales Representative.