

## Product Summary

BV <sub>SSS</sub>	R <sub>SS(ON)</sub> Typ	I <sub>S</sub> Max T <sub>A</sub> = +25°C
12V	2.5mΩ @ V <sub>GS</sub> = 3.8V	23.6A

## Description

This new generation MOSFET is designed to minimize the on-state resistance (R<sub>SS(ON)</sub>) and yet maintain superior switching performance, making it ideal for high efficiency power management applications.

## Applications

- Battery Management
- Load Switch
- Battery Protection

## Features

- CSP with Footprint 3.54mm × 1.77mm
- Height = 0.21mm for Low Profile
- ESD Protection of Gate
- Totally Lead-Free & Fully RoHS Compliant (Notes 1 & 2)**
- Halogen and Antimony Free. "Green" Device (Note 3)**
- For automotive applications requiring specific change control (i.e. parts qualified to AEC-Q100/101/200, PPAP capable, and manufactured in IATF 16949 certified facilities), please [contact us](mailto:contact@diodes.com) or your local Diodes representative. <https://www.diodes.com/quality/product-definitions/>**

## Mechanical Data

- Case: X3-DSN3518-6
- Terminal Connections: See Diagram Below
- Moisture Sensitivity: Level 1 per J-STD-020
- Terminals: Finish — NiPdAu. Solderable per MIL-STD-202, Method 208 (e4)
- Weight: 0.0026 grams (Approximate)



X3-DSN3518-6 (Type B)

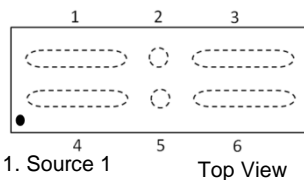

- Source 1
- Gate 1
- Source 1
- Source 2
- Gate 2
- Source 2

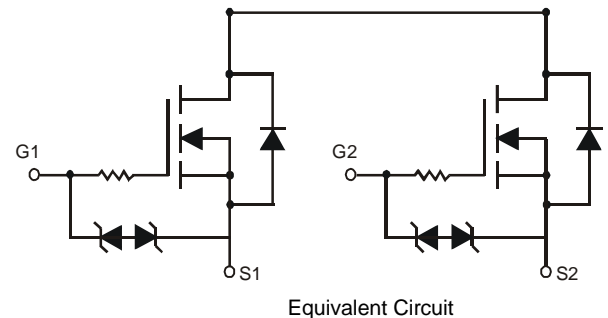

## Ordering Information (Note 4)

Part Number	Case	Packaging
DMN13M9UCA6-7	X3-DSN3518-6 (Type B)	3000/Tape & Reel

- Notes:
- No purposely added lead. Fully EU Directive 2002/95/EC (RoHS), 2011/65/EU (RoHS 2) & 2015/863/EU (RoHS 3) compliant.
  - See <https://www.diodes.com/quality/lead-free/> for more information about Diodes Incorporated's definitions of Halogen- and Antimony-free, "Green" and Lead-free.
  - Halogen- and Antimony-free "Green" products are defined as those which contain <900ppm bromine, <900ppm chlorine (<1500ppm total Br + Cl) and <1000ppm antimony compounds.
  - For packaging details, go to our website at <https://www.diodes.com/design/support/packaging/diodes-packaging/>.

## Marking Information

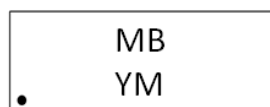

MB= Product Type Marking Code  
 YM = Date Code Marking  
 Y or  $\bar{Y}$  = Year (ex: G = 2019)  
 M or  $\bar{M}$  = Month (ex: 9 = September)

### Date Code Key

Year	2015	2016	2017	2018	2019	2020	2021
Code	C	D	E	F	G	H	I

Month	Jan	Feb	Mar	Apr	May	Jun	Jul	Aug	Sep	Oct	Nov	Dec
Code	1	2	3	4	5	6	7	8	9	O	N	D

**Maximum Ratings** (@T<sub>A</sub> = +25°C, unless otherwise specified.)

Characteristic			Symbol	Value	Unit
Source-Source Voltage			V <sub>SSS</sub>	12	V
Gate-Source Voltage			V <sub>GSS</sub>	±8	V
Continuous Source Current (Note 5) V <sub>GS</sub> = 4.5V	Steady State	T <sub>A</sub> = +25°C	I <sub>S</sub>	23.6	A
		T <sub>A</sub> = +70°C		18.9	
Continuous Source Current (Note 5) V <sub>GS</sub> = 2.5V	Steady State	T <sub>A</sub> = +25°C	I <sub>S</sub>	16.8	A
		T <sub>A</sub> = +70°C		13.4	
Pulsed Source Current (Note 6)			I <sub>SM</sub>	100	A

**Thermal Characteristics**

Characteristic	Symbol	Value	Unit
Power Dissipation (Note 7)	P <sub>D</sub>	1.05	W
Thermal Resistance, Junction to Ambient @T <sub>A</sub> = +25°C (Note 7)	R <sub>θJA</sub>	120.7	°C/W
Power Dissipation (Note 5)	P <sub>D</sub>	2.67	W
Thermal Resistance, Junction to Ambient @T <sub>A</sub> = +25°C (Note 5)	R <sub>θJA</sub>	46.8	°C/W
Operating and Storage Temperature Range	T <sub>J</sub> , T <sub>STG</sub>	-55 to +150	°C

**Electrical Characteristics** (@T<sub>A</sub> = +25°C, unless otherwise specified.)

Characteristic	Symbol	Min	Typ	Max	Unit	Test Condition
<b>OFF CHARACTERISTICS (Note 8)</b>						
Source-Source Breakdown Voltage	BV <sub>SSS</sub>	12	—	—	V	V <sub>GS</sub> = 0V, I <sub>S</sub> = 1mA
Zero Gate Voltage Source Current T <sub>J</sub> = +25°C	I <sub>SSS</sub>	—	—	1	μA	V <sub>SS</sub> = 10V, V <sub>GS</sub> = 0V
Gate-Source Leakage	I <sub>GSS</sub>	—	—	±10	μA	V <sub>GS</sub> = ±8V, V <sub>SS</sub> = 0V
<b>ON CHARACTERISTICS (Note 8)</b>						
Gate Threshold Voltage	V <sub>GS(TH)</sub>	0.5	—	1.3	V	V <sub>SS</sub> = 6V, I <sub>S</sub> = 1mA
Static Source-Source On-Resistance	R <sub>SS(ON)</sub>	1.2	2.3	3.2	mΩ	V <sub>GS</sub> = 4.5V, I <sub>S</sub> = 5A
		1.2	2.4	3.2		V <sub>GS</sub> = 4.0V, I <sub>S</sub> = 5A
		1.3	2.5	3.4		V <sub>GS</sub> = 3.8V, I <sub>S</sub> = 5A
		1.3	2.7	4.6		V <sub>GS</sub> = 3.1V, I <sub>S</sub> = 5A
		1.4	3.0	6.5		V <sub>GS</sub> = 2.5V, I <sub>S</sub> = 5A
Diode Forward Voltage	V <sub>SS</sub>	—	0.7	1.2	V	V <sub>GS</sub> = 0V, I <sub>S</sub> = 3A
<b>DYNAMIC CHARACTERISTICS (Note 9)</b>						
Input Capacitance	C <sub>ISS</sub>	—	3315	—	pF	V <sub>SS</sub> = 6V, V <sub>GS</sub> = 0V, f = 1.0MHz
Output Capacitance	C <sub>OSS</sub>	—	850	—		
Reverse Transfer Capacitance	C <sub>RSS</sub>	—	248	—		
Total Gate Charge	Q <sub>g</sub>	—	56.5	—	nC	V <sub>SS</sub> = 6V, V <sub>GS</sub> = 4.5V, I <sub>S</sub> = 27A
Gate-Source Charge	Q <sub>gs</sub>	—	8.8	—		
Gate-Drain Charge	Q <sub>gd</sub>	—	13.3	—		
Gate Charge at V <sub>TH</sub>	Q <sub>g(TH)</sub>	—	6.9	—		
Turn-On Delay Time	t <sub>D(ON)</sub>	—	603	—	ns	V <sub>SS</sub> = 6V, V <sub>GS</sub> = 4.5V, I <sub>S</sub> = 3A
Turn-On Rise Time	t <sub>R</sub>	—	1694	—		
Turn-Off Delay Time	t <sub>D(OFF)</sub>	—	4749	—		
Turn-Off Fall Time	t <sub>F</sub>	—	6208	—		

- Notes:
- Device mounted on FR-4 material with 1-inch<sup>2</sup> (6.45-cm<sup>2</sup>), 2-oz. (0.071-mm thick) Cu.
  - Repetitive rating, pulse width limited by junction temperature.
  - Device mounted on FR-4 PCB with minimum recommended pad layout, single sided.
  - Short duration pulse test used to minimize self-heating effect.
  - Guaranteed by design. Not subject to production testing.

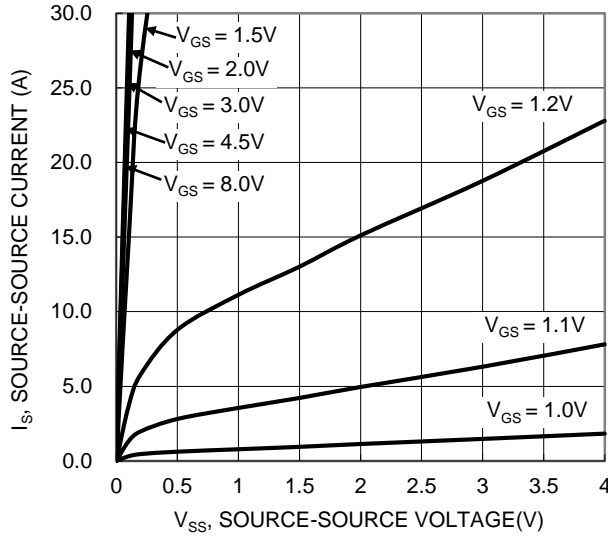

Figure 1. Typical Output Characteristic

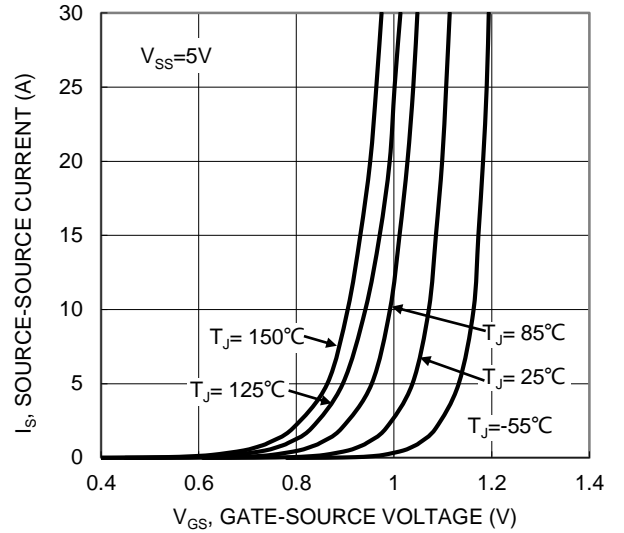

Figure 2. Typical Transfer Characteristic

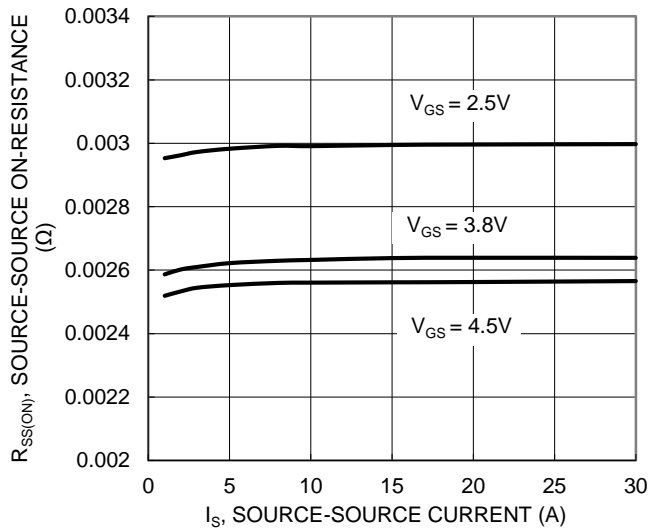

Figure 3. Typical On-Resistance vs. Source Current and Gate Voltage

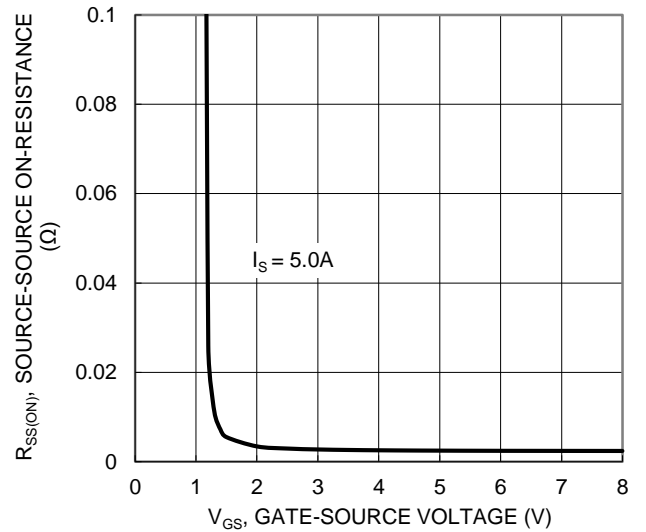

Figure 4. Typical Transfer Characteristic

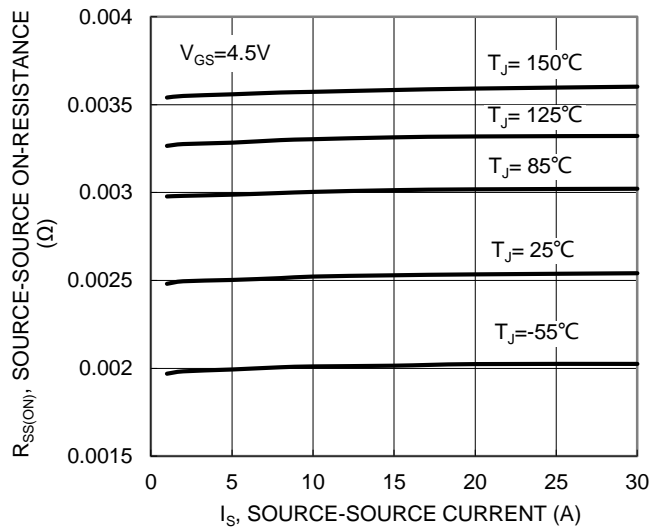

Figure 5. Typical On-Resistance vs. Source Current and Junction Temperature

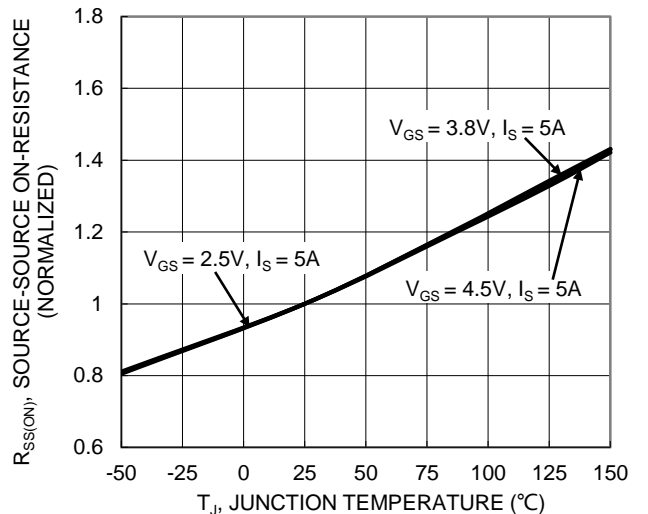
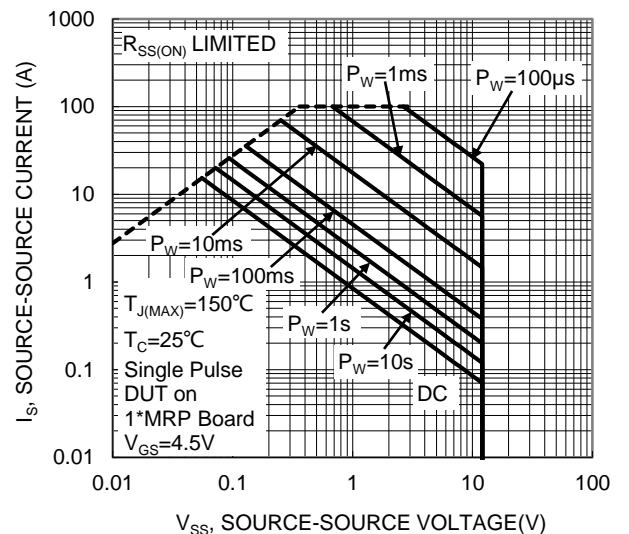
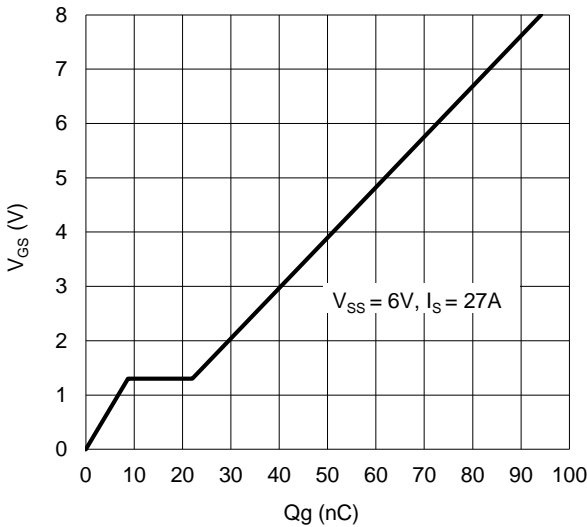
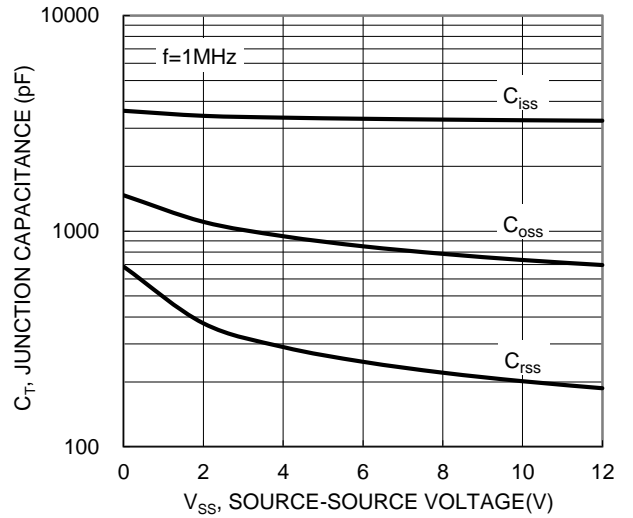
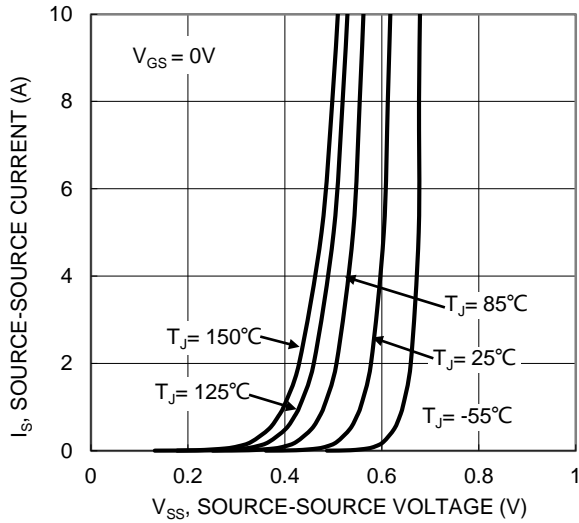
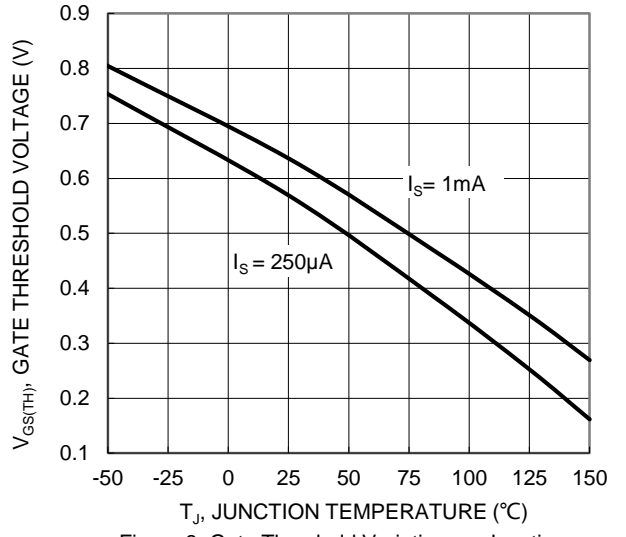
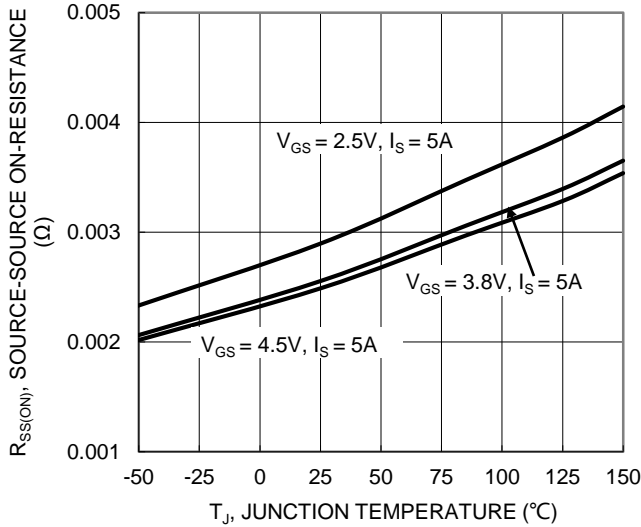

Figure 6. On-Resistance Variation with Junction Temperature



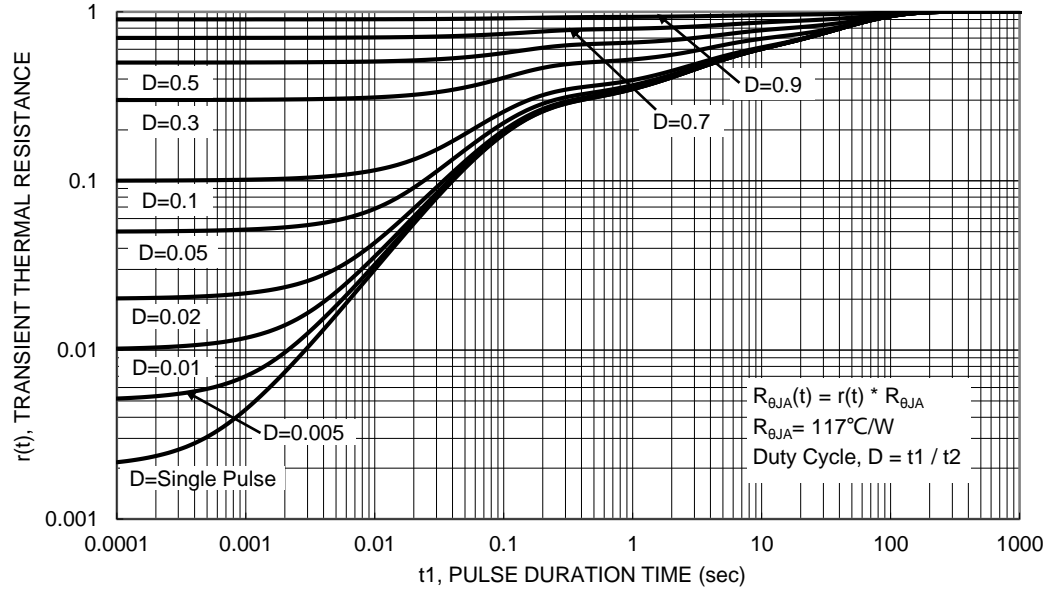
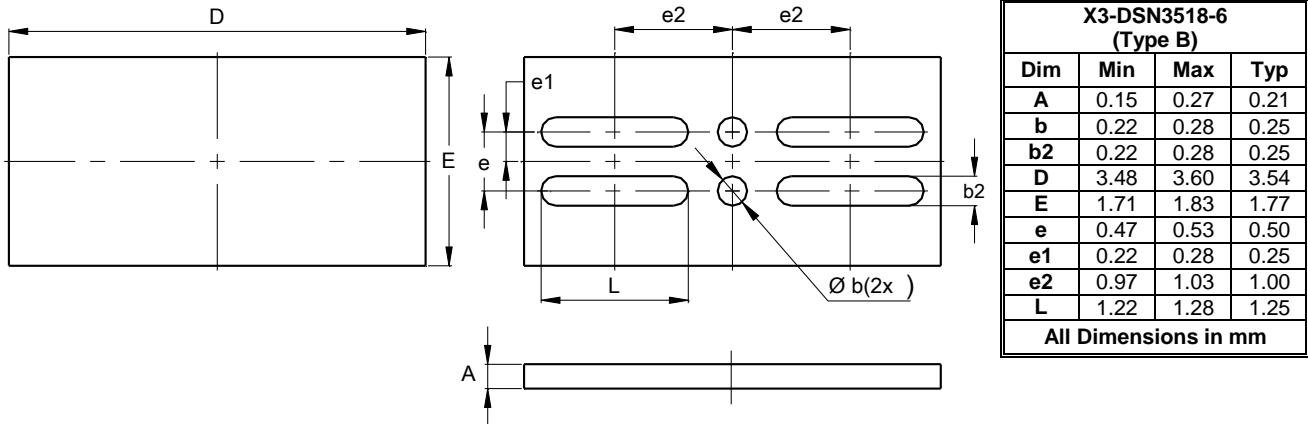

Figure 13. Transient Thermal Resistance

**Package Outline Dimensions**

Please see <http://www.diodes.com/package-outlines.html> for the latest version.

**X3-DSN3518-6 (Type B)**



**Suggested Pad Layout**

Please see <http://www.diodes.com/package-outlines.html> for the latest version.

**X3-DSN3518-6 (Type B)**

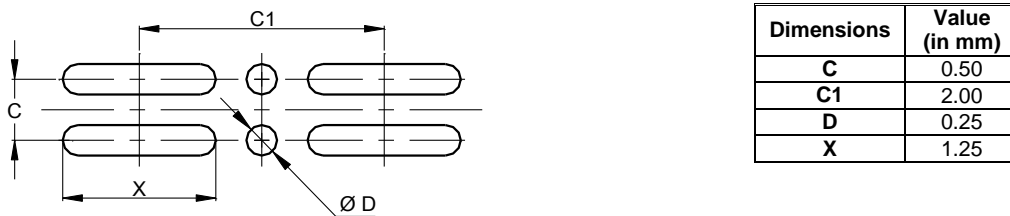

**IMPORTANT NOTICE**

DIODES INCORPORATED MAKES NO WARRANTY OF ANY KIND, EXPRESS OR IMPLIED, WITH REGARDS TO THIS DOCUMENT, INCLUDING, BUT NOT LIMITED TO, THE IMPLIED WARRANTIES OF MERCHANTABILITY AND FITNESS FOR A PARTICULAR PURPOSE (AND THEIR EQUIVALENTS UNDER THE LAWS OF ANY JURISDICTION).

Diodes Incorporated and its subsidiaries reserve the right to make modifications, enhancements, improvements, corrections or other changes without further notice to this document and any product described herein. Diodes Incorporated does not assume any liability arising out of the application or use of this document or any product described herein; neither does Diodes Incorporated convey any license under its patent or trademark rights, nor the rights of others. Any Customer or user of this document or products described herein in such applications shall assume all risks of such use and will agree to hold Diodes Incorporated and all the companies whose products are represented on Diodes Incorporated website, harmless against all damages.

Diodes Incorporated does not warrant or accept any liability whatsoever in respect of any products purchased through unauthorized sales channel. Should Customers purchase or use Diodes Incorporated products for any unintended or unauthorized application, Customers shall indemnify and hold Diodes Incorporated and its representatives harmless against all claims, damages, expenses, and attorney fees arising out of, directly or indirectly, any claim of personal injury or death associated with such unintended or unauthorized application.

Products described herein may be covered by one or more United States, international or foreign patents pending. Product names and markings noted herein may also be covered by one or more United States, international or foreign trademarks.

This document is written in English but may be translated into multiple languages for reference. Only the English version of this document is the final and determinative format released by Diodes Incorporated.

**LIFE SUPPORT**

Diodes Incorporated products are specifically not authorized for use as critical components in life support devices or systems without the express written approval of the Chief Executive Officer of Diodes Incorporated. As used herein:

A. Life support devices or systems are devices or systems which:

1. are intended to implant into the body, or
2. support or sustain life and whose failure to perform when properly used in accordance with instructions for use provided in the labeling can be reasonably expected to result in significant injury to the user.

B. A critical component is any component in a life support device or system whose failure to perform can be reasonably expected to cause the failure of the life support device or to affect its safety or effectiveness.

Customers represent that they have all necessary expertise in the safety and regulatory ramifications of their life support devices or systems, and acknowledge and agree that they are solely responsible for all legal, regulatory and safety-related requirements concerning their products and any use of Diodes Incorporated products in such safety-critical, life support devices or systems, notwithstanding any devices- or systems-related information or support that may be provided by Diodes Incorporated. Further, Customers must fully indemnify Diodes Incorporated and its representatives against any damages arising out of the use of Diodes Incorporated products in such safety-critical, life support devices or systems.

Copyright © 2019, Diodes Incorporated

[www.diodes.com](http://www.diodes.com)