

EVALUATION KIT
AVAILABLE**MAXIM**

5GHz to 6GHz Low-Noise Amplifier in 6-Pin UCSP

MAX2648

General Description

The MAX2648 high-linearity, silicon-germanium (SiGe) low-noise amplifier (LNA) is designed for 5GHz wireless LAN systems based on IEEE 802.11a and HiperLAN2 standards. The LNA provides high gain, low noise, and high linearity performance, allowing it to be used as a first-stage LNA, an LO buffer, or a transmitter driver amplifier. This highly versatile amplifier provides 17dB gain, 1.8dB noise figure, and 0dBm input third-order intercept point (IIP3) while consuming only 12mA.

The MAX2648 is designed on a low-noise, advanced SiGe process optimized for high-frequency applications. It operates over a +2.7V to +3.6V supply range. The device is packaged in a tiny 2x3 chipscale package (UCSP™) with six solder bumps, measuring 1.0mm x 1.5mm.

Features

- ◆ 5GHz to 6GHz Wideband Operation
- ◆ Low Noise Figure: 1.8dB at 5.25GHz
- ◆ High Gain: 17dB
- ◆ High IIP3: 0dBm
- ◆ +2.7V to +3.6V Single-Supply Operation
- ◆ Chip-Scale Package (UCSP) Measuring 1.0mm × 1.5mm

Ordering Information

PART	TEMP RANGE	PIN-PACKAGE
MAX2648EBT-T	-40°C to +85°C	2 × 3 UCSP

Pin Configuration

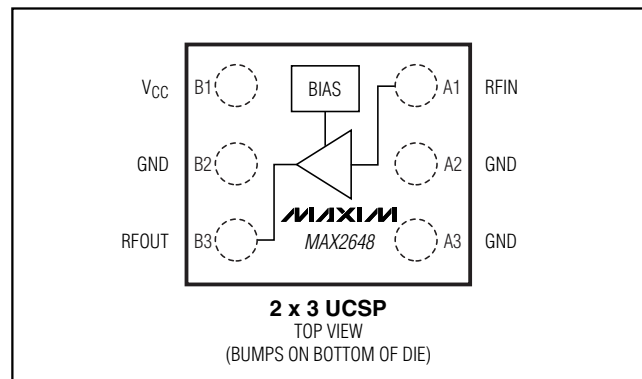

Applications

IEEE 802.11a Wireless LAN
ETSI HiperLAN/2
5GHz ISM
Microwave Radios

UCSP is a trademark of Maxim Integrated Products, Inc.

Typical Application Circuit

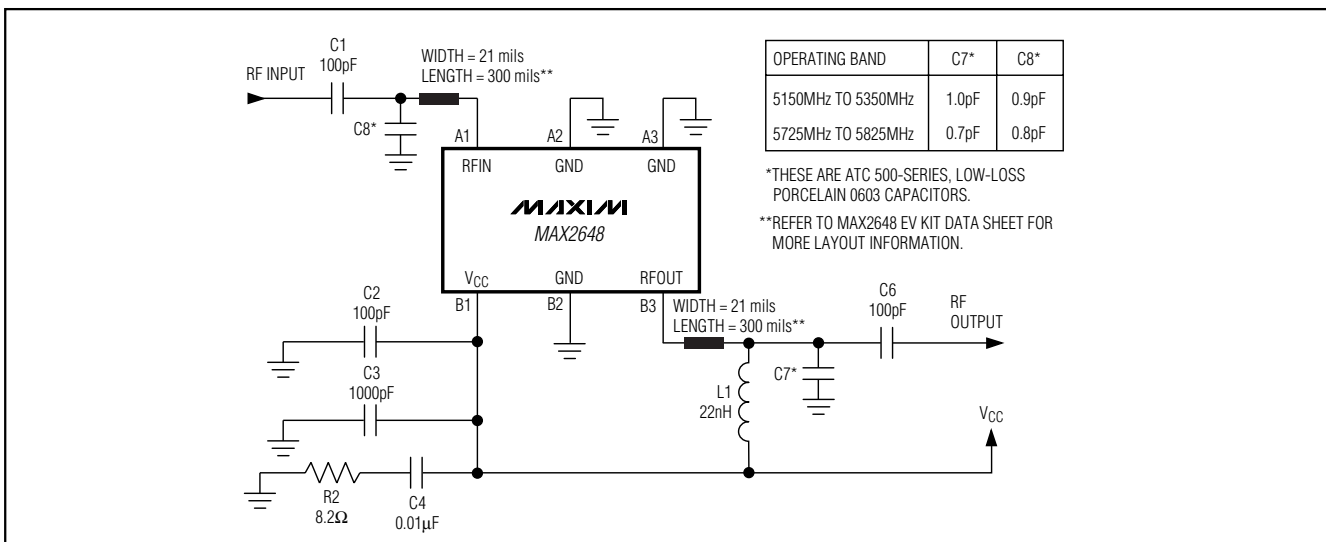
**MAXIM**

Maxim Integrated Products 1

For pricing, delivery, and ordering information, please contact Maxim/Dallas Direct! at 1-888-629-4642, or visit Maxim's website at www.maxim-ic.com.

5GHz to 6GHz Low-Noise Amplifier in 6-Pin UCSP

ABSOLUTE MAXIMUM RATINGS

V _{CC} to GND	-0.3V to +6.0V	Operating Temperature Range	-40°C to +85°C
RFOUT to GND	-0.3V to +6.0V	Junction Temperature	+150°C
RFIN	-0.3V to +0.8V	Storage Temperature Range	-55°C to +150°C
RFIN Power (50Ω source)	+15dBm		
Continuous Power Dissipation 2 × 3-Bump UCSP (derate 24mW/°C above +70°C)	500mW		

Stresses beyond those listed under "Absolute Maximum Ratings" may cause permanent damage to the device. These are stress ratings only, and functional operation of the device at these or any other conditions beyond those indicated in the operational sections of the specifications is not implied. Exposure to absolute maximum rating conditions for extended periods may affect device reliability.

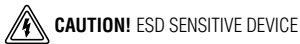

DC ELECTRICAL CHARACTERISTICS

(V_{CC} = +2.7V to +3.6V, no RF signals applied, RFIN and RFOUT terminated in 50Ω through a DC-blocking capacitor, RFOUT connected to V_{CC}. Typical values for V_{CC} = +3.0V, T_A = +25°C, unless otherwise noted.)

PARAMETER	SYMBOL	CONDITIONS	MIN	TYP	MAX	UNITS
Supply Voltage Range	V _{CC}		2.7		3.6	V
Supply Current	I _{CC}	T _A = +25°C		12.3	15	mA
		T _A = -40°C to +85°C (Note 1)			18	

Note 1: Limits are guaranteed by design and characterization, and are not production tested.

AC ELECTRICAL CHARACTERISTICS

(MAX2648 evaluation kit, V_{CC} = +3.0V, f_{IN} = 5250MHz, P_{IN} = -30dBm, 50Ω system, T_A = +25°C. Typical values for V_{CC} = +3.0V, T_A = +25°C, unless otherwise noted. All limits are guaranteed by design and characterization and are not production tested.)

PARAMETER	SYMBOL	CONDITIONS	MIN	TYP	MAX	UNITS
Frequency Range	f _{IN}	(Note 2)		5250		MHz
Power Gain	S ₂₁	(Note 3)	16	17.4		dB
Maximum Gain Variation over Temperature		T _A = -40°C to +85°C		0.2	1.0	dB
Input Third Order Intercept	IIP3	Two tones at 5250MHz and 5251MHz, -30dBm per tone (Note 4)	-4.0	0		dBm
Noise Figure	NF	(Note 4)		1.8	2.3	dB
Input Return Loss	S ₁₁			-14		dB
Output Return Loss	S ₂₂			-14		dB
Reverse Isolation	S ₁₂			-31		dB

Note 2: The recommended operating range is 5100MHz to 5850MHz. Operation outside this frequency range is possible but has not been characterized. The device is matched, characterized, and tested at 5250MHz. For optimum performance at a given frequency, the input and output ports must be properly matched. See *Applications Information* section for more information on matching.

Note 3: Specifications are corrected for board losses (0.4dB at input, 0.4dB at output)

Note 4: Specification is corrected for board losses (0.4dB at input)

5GHz to 6GHz Low-Noise Amplifier in 6-Pin UCSP

MAX2648

Typical Operating Characteristics

(MAX2648 evaluation kit tuned for 5150MHz to 5350MHz, $V_{CC} = +3.0V$, $f_{IN} = 5250MHz$, $P_{IN} = -30dBm$, 50Ω system, $T_A = +25^\circ C$, unless otherwise noted.)

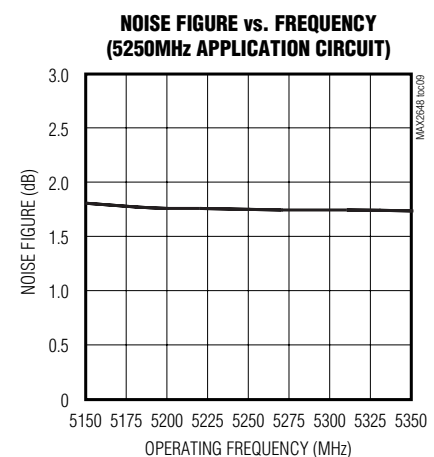
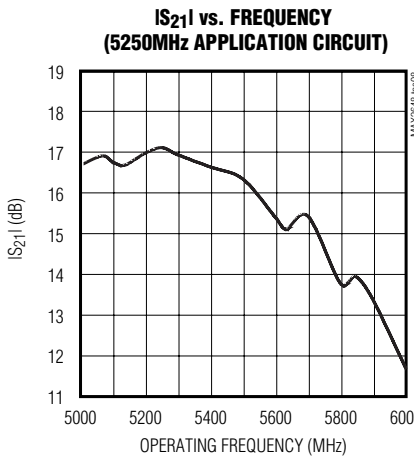
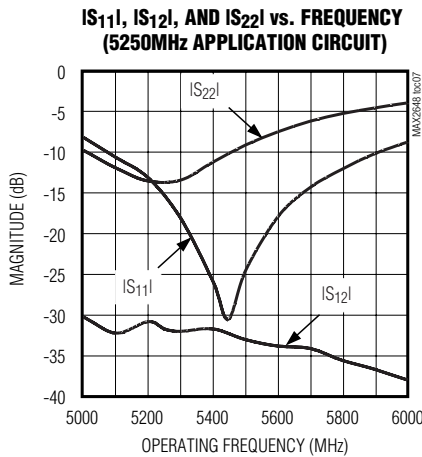
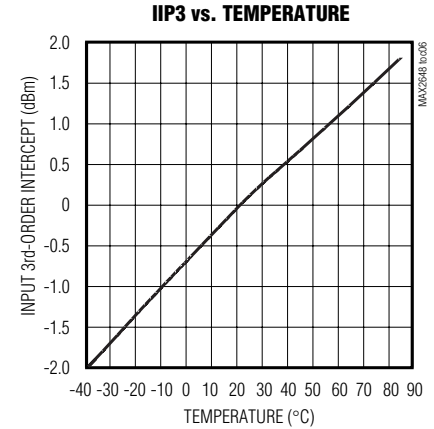
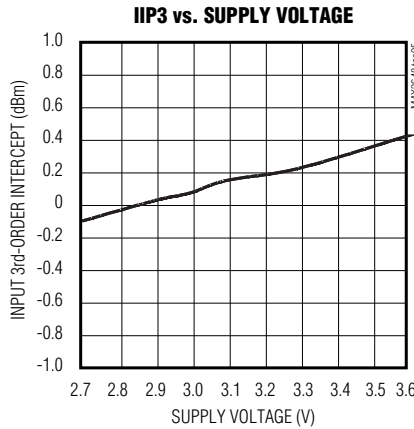
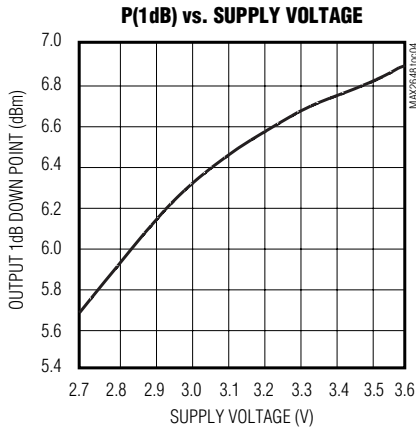
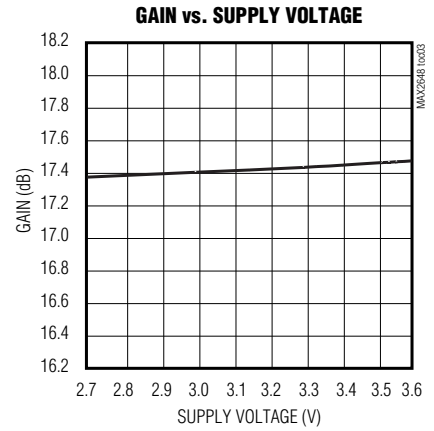
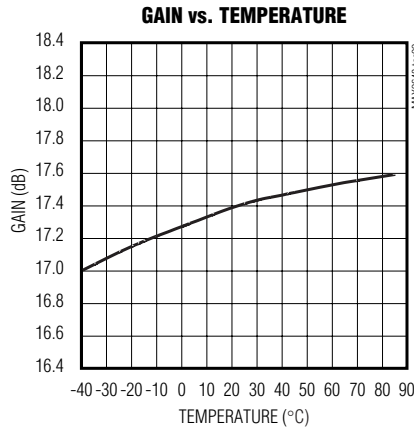
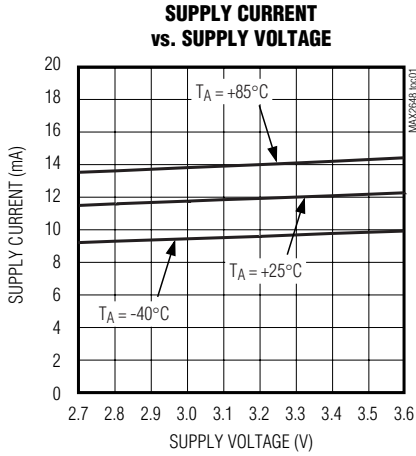

5GHz to 6GHz Low-Noise Amplifier in 6-Pin UCSP

Typical Operating Characteristics (continued)

(MAX2648 evaluation kit tuned for 5150MHz to 5350MHz, $V_{CC} = +3.0V$, $f_{IN} = 5250MHz$, $P_{IN} = -30dBm$, 50Ω system, $T_A = +25^\circ C$, unless otherwise noted.)

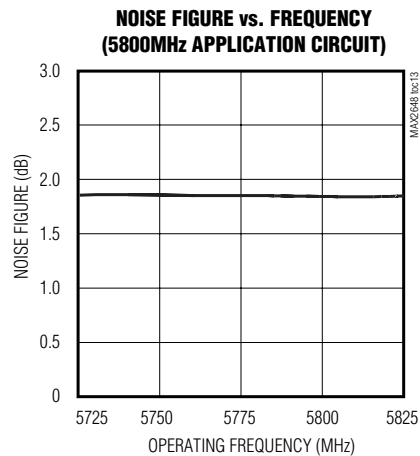
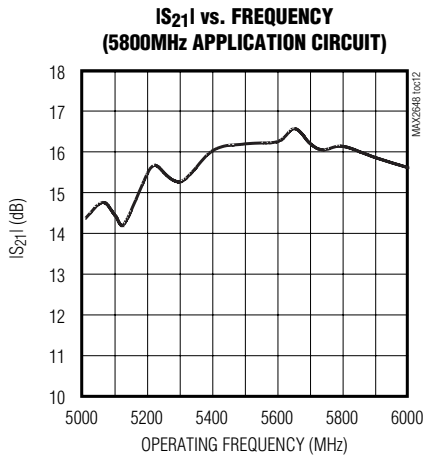
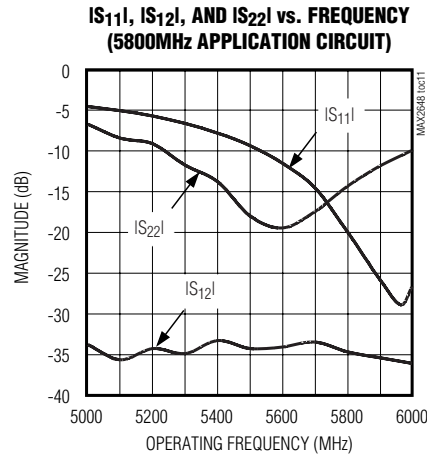
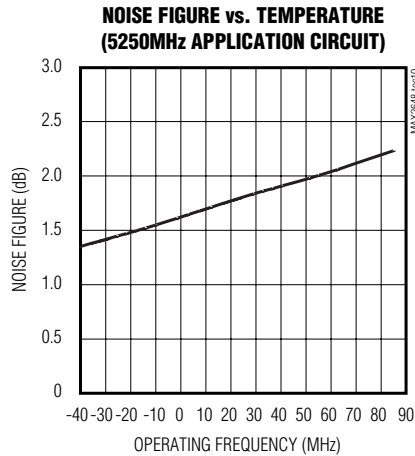

Pin Description

PIN	NAME	FUNCTION
A1	RFIN	Amplifier Input. AC-couple to this pin with a DC-blocking capacitor. External matching network is required for optimum performance.
A2, A3, B2	GND	Ground. Provide a low-inductance connection to the ground plane.
B3	RFOUT	Amplifier Output. Provide DC bias to V_{CC} through an RF choke or a quarter-wave transmission line (see evaluation kit layout). External matching network is required for optimum performance.
B1	V_{CC}	Power-Supply Input. Bypass directly to ground plane at this bump. Additional bypassing may be necessary for long V_{CC} lines.

5GHz to 6GHz Low-Noise Amplifier in 6-Pin UCSP

MAX2648

Detailed Description

The MAX2648 low-noise amplifier offers high gain, high linearity, and low-noise performance from 5GHz to 6GHz. This LNA also functions as a PA predriver or an LO buffer. The device has been fully characterized and tested in the 5.2GHz and 5.8GHz bands.

Applications Information

Optimal gain and noise figure performance requires input and output matching circuits tuned for the band of interest. All electrical specifications and typical operating characteristics are measured on the MAX2648 evaluation kit (EV kit), which is tuned for operation in the 5.2GHz band. Referencing the application circuit, PC board layout, and components specified in the MAX2648 EV kit data sheet will reduce evaluation and design time for 5.2GHz ISM-band system designs. For applications in other bands, refer to the MAX2648 [S]-parameters (Table 1), noise parameters (Table 2), and comments below to aid design.

Input Matching

The input stage is internally biased, so no external bias circuitry is required at RFIN. Be sure to AC-couple to the input.

Since the noise figure of the LNA design is severely degraded by low-Q matching components, always design with high-Q wire-wound inductors and low-loss capacitors. Remember that package parasitics must be taken into consideration; always use components with self-resonant frequencies higher than the intended frequency of operation.

Output Matching

The output of the MAX2648 is an open-collector transistor; the DC bias and RF matching network are off-chip as illustrated in the *Typical Application Circuit*. Bias the output stage with VCC through an RF choke, leaving as little pad exposed as possible—any exposed pad here will act like a small tuning stub and contribute a small, low-Q, shunt capacitor to the matching network.

If area allows, a better way to supply a bias for narrow-band operation is to design in a quarter-wave transmission line. The far side of this high-Z₀ transmission line is AC-shortened to ground with a radial stub; low-frequency decoupling is handled by a 1000pF shunt capacitor to ground nearby. Bias this point through an RF choke, and decouple the supply with a few μF at the VCC connection.

Power-Supply Bypassing

Proper power-supply bypassing is essential for high-frequency circuit stability. Place a small value capacitor as close to the IC as possible to decouple high-frequency noise. Place a larger value capacitor near the supply to decouple low-frequency noise. Whenever possible, place the ground-connected side of bypass capacitors within a few millimeters of the IC's ground connections.

Layout Considerations

A properly designed PC board is an essential part of any RF/microwave circuit. Keep RF signal lines as short as possible to reduce losses, EMI, and stray inductance. Use multiple separate low-inductance-plated vias to the ground plane for each ground bump.

The chip-scale package (UCSP) has a bump pitch of 0.5mm (19.7mil) and a bump diameter of 0.3mm (12mil). Therefore, lay out the solder pad spacing on 0.5mm (19.7mil) centers, and use a pad size of 0.25mm (10mil) and a solder mask opening of 0.33mm (13mil). Round or square pads are permissible. Refer to the Maxim application note, *Wafer Level Ultra-Chip-Scale Packaging*, for additional detailed information on UCSP layout and handling.

Chip Information

TRANSISTOR COUNT: 85

5GHz to 6GHz Low-Noise Amplifier in 6-Pin UCSP

Table 1. MAX2648 Typical Device [S] Parameters

 (T_A = +25°C, V_{CC} = +3.0V, Z_S = Z_L = 50Ω, input and output matching network not included).

FREQUENCY (MHZ)	S ₁₁		S ₂₁			S ₁₂		S ₂₂	
	S ₁₁	∠ S ₁₁	dB	S ₂₁	∠ S ₂₁	S ₁₂	∠ S ₁₂	S ₂₂	∠ S ₂₂
100	0.830	-12.7	27.1	22.89	171.3	0.004	72.6	0.984	-6.3
500	0.797	-63.4	25.5	18.88	138.8	0.016	46.6	0.837	-27.0
1000	0.774	-101.4	23.0	14.21	113.6	0.023	28.5	0.706	-40.7
1500	0.774	-126.2	20.6	10.76	94.2	0.025	14.3	0.636	-50.9
2000	0.774	-142.5	18.5	8.483	79.9	0.026	0.2	0.599	-59.5
2500	0.779	-153.2	16.7	6.893	67.6	0.023	-5.9	0.578	-69.9
3000	0.788	-162.4	14.9	5.573	57.8	0.025	-7.8	0.528	-78.8
3500	0.794	-170.0	13.7	4.859	49.8	0.023	-11.8	0.516	-83.0
4000	0.798	-176.3	12.6	4.306	40.7	0.024	-16.5	0.535	-88.0
4500	0.800	178.0	11.6	3.810	32.0	0.024	-27.5	0.553	-95.1
4600	0.803	176.6	11.4	3.733	30.2	0.019	-32.5	0.564	-96.5
4700	0.809	175.5	11.1	3.616	27.6	0.018	-29.4	0.565	-97.8
4800	0.802	174.8	11.0	3.550	26.0	0.022	-39.1	0.575	-99.1
4900	0.803	173.7	10.8	3.481	24.5	0.018	-30.3	0.571	-100.1
5000	0.803	172.9	10.6	3.426	22.4	0.019	-35.8	0.580	-102.4
5100	0.806	172.1	10.5	3.361	21.1	0.018	-34.5	0.587	-103.2
5200	0.801	171.0	10.4	3.324	19.8	0.022	-35.9	0.591	-104.9
5300	0.803	170.6	10.1	3.223	17.1	0.017	-42.7	0.603	-106.6
5400	0.804	169.7	10.0	3.174	15.5	0.017	-29.1	0.600	-107.4
5500	0.809	168.4	9.81	3.094	14.1	0.012	-40.4	0.604	-109.4
5600	0.807	167.7	9.69	3.054	12.2	0.014	-34.7	0.612	-110.8
5700	0.813	167.0	9.46	2.974	10.6	0.014	-44.2	0.622	-112.2
5800	0.818	165.9	9.35	2.937	9.1	0.013	-46.2	0.621	-113.6
5900	0.817	165.7	9.11	2.854	6.5	0.011	-46.4	0.630	-115.6
6000	0.813	164.6	8.97	2.811	5.4	0.010	-44.1	0.637	-117.1

5GHz to 6GHz Low-Noise Amplifier in 6-Pin UCSP

MAX2648

Table 2. MAX2648 Typical Noise Parameters

(T_A = +25°C, V_{CC} = +3.0V, data from design simulation.)

FREQUENCY (MHZ)	F _{MIN} (dB)	Γ _{OPT}	∠ Γ _{OPT}	R _N (Ω)
5000	1.502	0.683	151.8	50.7
5100	1.528	0.687	159.0	52.2
5200	1.554	0.690	159.8	53.7
5300	1.581	0.692	160.6	55.2
5400	1.613	0.694	161.4	56.8
5500	1.647	0.696	162.2	58.5
5600	1.662	0.700	163.0	59.7
5700	1.672	0.702	163.8	60.8
5800	1.695	0.705	164.6	62.3
5900	1.722	0.707	165.3	63.8
6000	1.750	0.708	166.1	65.3

5GHz to 6GHz Low-Noise Amplifier in 6-Pin UCSP

Package Information

(The package drawing(s) in this data sheet may not reflect the most current specifications. For the latest package outline information go to www.maxim-ic.com/packages.)

6L UCSP/EPS

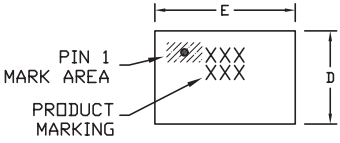

TOP VIEW

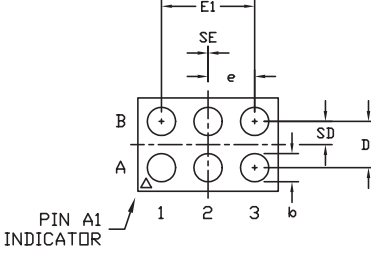

BOTTOM VIEW

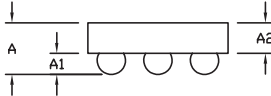

SIDE VIEW

COMMON DIMENSIONS		VARIABLE DIMENSIONS		DEPOPULATED SOLDER BALLS	
		D	E		
A	0.62±0.05-0.08	B6-1	1.00±0.05	1.52±0.05	NONE
A1	0.29±0.02	B6-2	1.00±0.05	1.52±0.05	B2
A2	0.33 REF.	B6-3	1.05±0.05	1.57±0.05	NONE
b	∅0.35±0.03	B6-4	1.05±0.05	1.57±0.05	B2
D1	0.50 BASIC	B6-5	0.97±0.05	1.46±0.05	NONE
e	0.50 BASIC	B6-6	1.16±0.05	1.57±0.05	NONE
SD	0.25 BASIC				
SE	0.00 BASIC				

NOTES:
 1. ALL DIMENSIONS ARE IN MILLIMETERS.
 2. PRODUCT MARKING: NUMBER OF CHARACTERS AND LINES VARY PER PRODUCT.

DALLAS SEMICONDUCTOR **MAXIM**

PROPRIETARY INFORMATION

TITLE:
PACKAGE OUTLINE, 3x2 UCSP

APPROVAL	DOCUMENT CONTROL NO. 21-0097	REV. G 1/1
----------	---------------------------------	------------

Maxim cannot assume responsibility for use of any circuitry other than circuitry entirely embodied in a Maxim product. No circuit patent licenses are implied. Maxim reserves the right to change the circuitry and specifications without notice at any time.

Maxim Integrated Products, 120 San Gabriel Drive, Sunnyvale, CA 94086 408-737-7600 _____ **8**