



# UC2842B/3B/4B/5B UC3842B/3B/4B/5B

## HIGH PERFORMANCE CURRENT MODE PWM CONTROLLER

- TRIMMED OSCILLATOR FOR PRECISE FREQUENCY CONTROL
- OSCILLATOR FREQUENCY GUARANTEED AT 250kHz
- CURRENT MODE OPERATION TO 500kHz
- AUTOMATIC FEED FORWARD COMPENSATION
- LATCHING PWM FOR CYCLE-BY-CYCLE CURRENT LIMITING
- INTERNALLY TRIMMED REFERENCE WITH UNDERVOLTAGE LOCKOUT
- HIGH CURRENT TOTEM POLE OUTPUT
- UNDERVOLTAGE LOCKOUT WITH HYSTERESIS
- LOW START-UP AND OPERATING CURRENT



comparator which also provides current limit control, and a totem pole output stage designed to source or sink high peak current. The output stage, suitable for driving N-Channel MOSFETs, is low in the off-state.

### DESCRIPTION

The UC384xB family of control ICs provides the necessary features to implement off-line or DC to DC fixed frequency current mode control schemes with a minimal external parts count. Internally implemented circuits include a trimmed oscillator for precise DUTY CYCLE CONTROL under voltage lockout featuring start-up current less than 0.5mA, a precision reference trimmed for accuracy at the error amp input, logic to insure latched operation, a PWM

Differences between members of this family are the under-voltage lockout thresholds and maximum duty cycle ranges. The UC3842B and UC3844B have UVLO thresholds of 16V (on) and 10V (off), ideally suited off-line applications. The corresponding thresholds for the UC3843B and UC3845B are 8.5V and 7.9V. The UC3842B and UC3843B can operate to duty cycles approaching 100%. A range of the zero to < 50% is obtained by the UC3844B and UC3845B by the addition of an internal toggle flip flop which blanks the output off every other clock cycle.

### BLOCK DIAGRAM (toggle flip flop used only in UC3844B and UC3845B)



## UC2842B/3B/4B/5B - UC3842B/3B/4B/5B

### ABSOLUTE MAXIMUM RATINGS

Symbol	Parameter	Value	Unit
$V_i$	Supply Voltage (low impedance source)	30	V
$V_i$	Supply Voltage ( $I_i < 30\text{mA}$ )	Self Limiting	
$I_o$	Output Current	$\pm 1$	A
$E_o$	Output Energy (capacitive load)	5	$\mu\text{J}$
	Analog Inputs (pins 2, 3)	-0.3 to 5.5	V
	Error Amplifier Output Sink Current	10	mA
$P_{\text{tot}}$	Power Dissipation at $T_{\text{amb}} \leq 25^\circ\text{C}$ (Minidip)	1.25	W
$P_{\text{tot}}$	Power Dissipation at $T_{\text{amb}} \leq 25^\circ\text{C}$ (SO8)	800	mW
$T_{\text{stg}}$	Storage Temperature Range	-65 to 150	$^\circ\text{C}$
$T_J$	Junction Operating Temperature	-40 to 150	$^\circ\text{C}$
$T_L$	Lead Temperature (soldering 10s)	300	$^\circ\text{C}$

\* All voltages are with respect to pin 5, all currents are positive into the specified terminal.

### PIN CONNECTION (top view)



### PIN FUNCTIONS

No	Function	Description
1	COMP	This pin is the Error Amplifier output and is made available for loop compensation.
2	$V_{\text{FB}}$	This is the inverting input of the Error Amplifier. It is normally connected to the switching power supply output through a resistor divider.
3	$I_{\text{SENSE}}$	A voltage proportional to inductor current is connected to this input. The PWM uses this information to terminate the output switch conduction.
4	$R_T/C_T$	The oscillator frequency and maximum Output duty cycle are programmed by connecting resistor $R_T$ to $V_{\text{ref}}$ and capacitor $C_T$ to ground. Operation to 500kHz is possible.
5	GROUND	This pin is the combined control circuitry and power ground.
6	OUTPUT	This output directly drives the gate of a power MOSFET. Peak currents up to 1A are sourced and sunk by this pin.
7	$V_{\text{CC}}$	This pin is the positive supply of the control IC.
8	$V_{\text{ref}}$	This is the reference output. It provides charging current for capacitor $C_T$ through resistor $R_T$ .

### ORDERING NUMBERS

SO8	Minidip
UC2842BD1; UC3842BD1	UC2842BN; UC3842BN
UC2843BD1; UC3843BD1	UC2843BN; UC3843BN
UC2844BD1; UC3844BD1	UC2844BN; UC3844BN
UC2845BD1; UC3845BD1	UC2845BN; UC3845BN

**THERMAL DATA**

Symbol	Description	Minidip	SO8	Unit
$R_{th\ j-amb}$	Thermal Resistance Junction-ambient.	max. 100	150	°C/W

**ELECTRICAL CHARACTERISTICS** ( [note 1] Unless otherwise stated, these specifications apply for  $-25 \leq T_{amb} \leq 85^{\circ}C$  for UC284XB;  $0 \leq T_{amb} \leq 70^{\circ}C$  for UC384XB;  $V_i = 15V$  (note 5);  $R_T = 10K$ ;  $C_T = 3.3nF$ )

Symbol	Parameter	Test Conditions	UC284XB			UC384XB			Unit
			Min.	Typ.	Max.	Min.	Typ.	Max.	
<b>REFERENCE SECTION</b>									
$V_{REF}$	Output Voltage	$T_j = 25^{\circ}C$ $I_o = 1mA$	4.95	5.00	5.05	4.90	5.00	5.10	V
$\Delta V_{REF}$	Line Regulation	$12V \leq V_i \leq 25V$		2	20		2	20	mV
$\Delta V_{REF}$	Load Regulation	$1 \leq I_o \leq 20mA$		3	25		3	25	mV
$\Delta V_{REF}/\Delta T$	Temperature Stability	(Note 2)		0.2			0.2		mV/°C
	Total Output Variation	Line, Load, Temperature	4.9		5.1	4.82		5.18	V
$e_N$	Output Noise Voltage	$10Hz \leq f \leq 10KHz$ $T_j = 25^{\circ}C$ (note 2)		50			50		$\mu V$
	Long Term Stability	$T_{amb} = 125^{\circ}C$ , 1000Hrs (note 2)		5	25		5	25	mV
$I_{SC}$	Output Short Circuit		-30	-100	-180	-30	-100	-180	mA
<b>OSCILLATOR SECTION</b>									
$f_{OSC}$	Frequency	$T_j = 25^{\circ}C$	49	52	55	49	52	55	KHz
		$T_A = T_{low}$ to $T_{high}$	48	-	56	48	-	56	KHz
		$T_j = 25^{\circ}C$ ( $R_T = 6.2k$ , $C_T = 1nF$ )	225	250	275	225	250	275	KHz
$\Delta f_{OSC}/\Delta V$	Frequency Change with Volt.	$V_{CC} = 12V$ to $25V$	-	0.2	1	-	0.2	1	%
$\Delta f_{OSC}/\Delta T$	Frequency Change with Temp.	$T_A = T_{low}$ to $T_{high}$	-	1	-	-	0.5	-	%
$V_{OSC}$	Oscillator Voltage Swing	(peak to peak)	-	1.6	-	-	1.6	-	V
$I_{dischg}$	Discharge Current ( $V_{OSC} = 2V$ )	$T_j = 25^{\circ}C$	7.8	8.3	8.8	7.8	8.3	8.8	mA
		$T_A = T_{low}$ to $T_{high}$	7.5	-	8.8	7.6	-	8.8	mA
<b>ERROR AMP SECTION</b>									
$V_2$	Input Voltage	$V_{PIN1} = 2.5V$	2.45	2.50	2.55	2.42	2.50	2.58	V
$I_b$	Input Bias Current	$V_{FB} = 5V$		-0.1	-1		-0.1	-2	$\mu A$
	$A_{VOL}$	$2V \leq V_o \leq 4V$	65	90		65	90		dB
BW	Unity Gain Bandwidth	$T_j = 25^{\circ}C$	0.7	1		0.7	1		MHz
PSRR	Power Supply Rejec. Ratio	$12V \leq V_i \leq 25V$	60	70		60	70		dB
$I_o$	Output Sink Current	$V_{PIN2} = 2.7V$ $V_{PIN1} = 1.1V$	2	12		2	12		mA
$I_o$	Output Source Current	$V_{PIN2} = 2.3V$ $V_{PIN1} = 5V$	-0.5	-1		-0.5	-1		mA
	$V_{OUT}$ High	$V_{PIN2} = 2.3V$ ; $R_L = 15K\Omega$ to Ground	5	6.2		5	6.2		V
	$V_{OUT}$ Low	$V_{PIN2} = 2.7V$ ; $R_L = 15K\Omega$ to Pin 8		0.8	1.1		0.8	1.1	V
<b>CURRENT SENSE SECTION</b>									
$G_V$	Gain	(note 3 & 4)	2.85	3	3.15	2.85	3	3.15	V/V
$V_3$	Maximum Input Signal	$V_{PIN1} = 5V$ (note 3)	0.9	1	1.1	0.9	1	1.1	V
SVR	Supply Voltage Rejection	$12 \leq V_i \leq 25V$ (note 3)		70			70		dB
$I_b$	Input Bias Current			-2	-10		-2	-10	$\mu A$
	Delay to Output			150	300		150	300	ns

## UC2842B/3B/4B/5B - UC3842B/3B/4B/5B

### ELECTRICAL CHARACTERISTICS (continued)

Symbol	Parameter	Test Conditions	UC284XB			UC384XB			Unit
			Min.	Typ.	Max.	Min.	Typ.	Max.	
<b>OUTPUT SECTION</b>									
V <sub>OL</sub>	Output Low Level	I <sub>SINK</sub> = 20mA		0.1	0.4		0.1	0.4	V
		I <sub>SINK</sub> = 200mA		1.6	2.2		1.6	2.2	V
V <sub>OH</sub>	Output High Level	I <sub>SOURCE</sub> = 20mA	13	13.5		13	13.5		V
		I <sub>SOURCE</sub> = 200mA	12	13.5		12	13.5		V
V <sub>OLS</sub>	UVLO Saturation	V <sub>CC</sub> = 6V; I <sub>SINK</sub> = 1mA		0.1	1.1		0.1	1.1	V
t <sub>r</sub>	Rise Time	T <sub>j</sub> = 25°C C <sub>L</sub> = 1nF (2)		50	150		50	150	ns
t <sub>f</sub>	Fall Time	T <sub>j</sub> = 25°C C <sub>L</sub> = 1nF (2)		50	150		50	150	ns
<b>UNDER-VOLTAGE LOCKOUT SECTION</b>									
	Start Threshold	X842B/4B	15	16	17	14.5	16	17.5	V
		X843B/5B	7.8	8.4	9.0	7.8	8.4	9.0	V
	Min Operating Voltage After Turn-on	X842B/4B	9	10	11	8.5	10	11.5	V
		X843B/5B	7.0	7.6	8.2	7.0	7.6	8.2	V
<b>PWM SECTION</b>									
	Maximum Duty Cycle	X842B/3B	94	96	100	94	96	100	%
		X844B/5B	47	48	50	47	48	50	%
	Minimum Duty Cycle			0			0	%	
<b>TOTAL STANDBY CURRENT</b>									
I <sub>st</sub>	Start-up Current	V <sub>i</sub> = 6.5V for UCX843B/45B		0.3	0.5		0.3	0.5	mA
		V <sub>i</sub> = 14V for UCX842B/44B		0.3	0.5		0.3	0.5	mA
I <sub>i</sub>	Operating Supply Current	V <sub>PIN2</sub> = V <sub>PIN3</sub> = 0V		12	17		12	17	mA
V <sub>iz</sub>	Zener Voltage	I <sub>i</sub> = 25mA	30	36		30	36	V	

- Notes :**
1. Max package power dissipation limits must be respected; low duty cycle pulse techniques are used during test maintain T<sub>j</sub> as close to T<sub>amb</sub> as possible.
  2. These parameters, although guaranteed, are not 100% tested in production.
  3. Parameter measured at trip point of latch with V<sub>PIN2</sub> = 0.
  4. Gain defined as :  

$$A = \frac{\Delta V_{PIN1}}{\Delta V_{PIN3}} ; 0 \leq V_{PIN3} \leq 0.8 \text{ V}$$
  5. Adjust V<sub>i</sub> above the start threshold before setting at 15 V.

Figure 1: Open Loop Test Circuit.

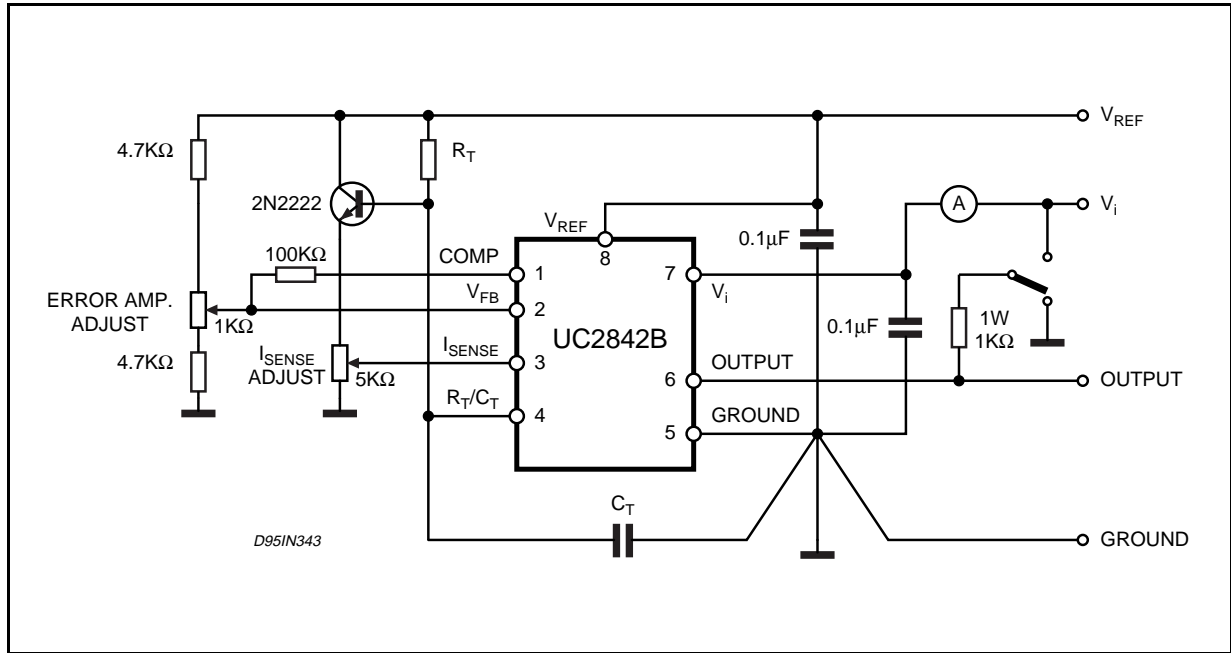

High peak currents associated with capacitive loads necessitate careful grounding techniques. Timing and bypass capacitors should be connected close

to pin 5 in a single point ground. The transistor and 5 KΩ potentiometer are used to sample the oscillator waveform and apply an adjustable ramp to pin 3.

Figure 2: Timing Resistor vs. Oscillator Frequency



Figure 3: Output Dead-Time vs. Oscillator Frequency



**Figure 4:** Oscillator Discharge Current vs. Temperature.

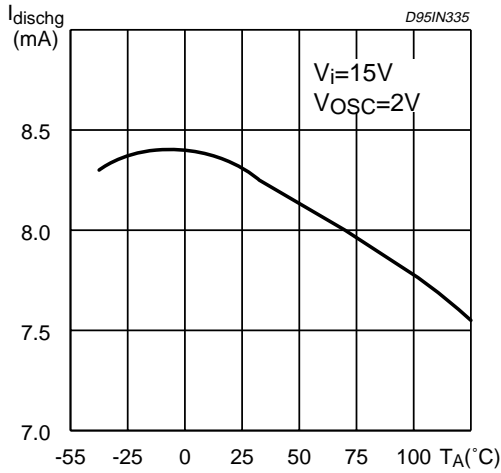

**Figure 5:** Maximum Output Duty Cycle vs. Timing Resistor.

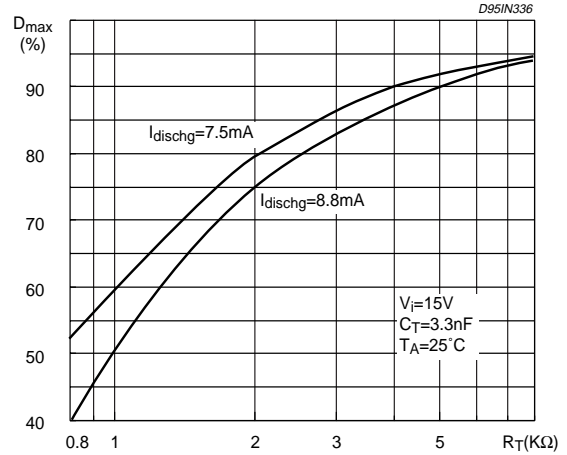

**Figure 6:** Error Amp Open-Loop Gain and Phase vs. Frequency.

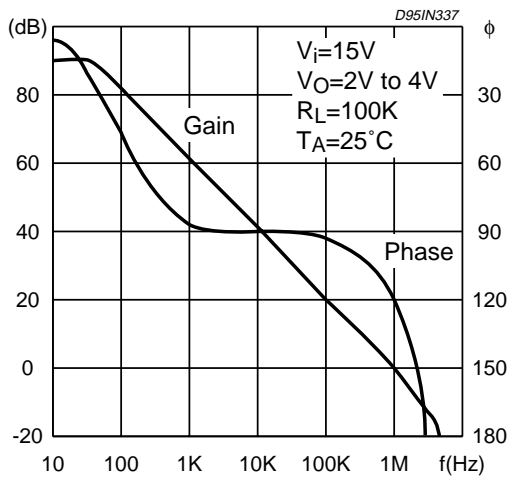

**Figure 7:** Current Sense Input Threshold vs. Error Amp Output Voltage.

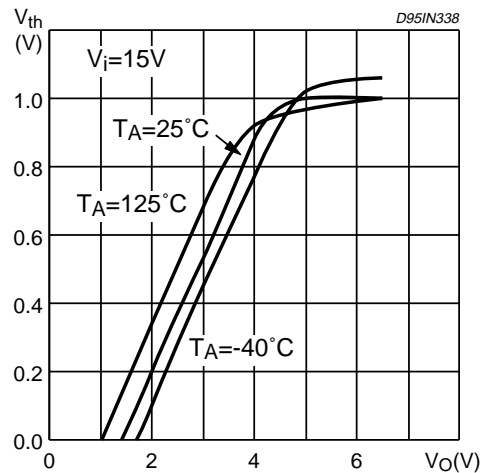

**Figure 8:** Reference Voltage Change vs. Source Current.

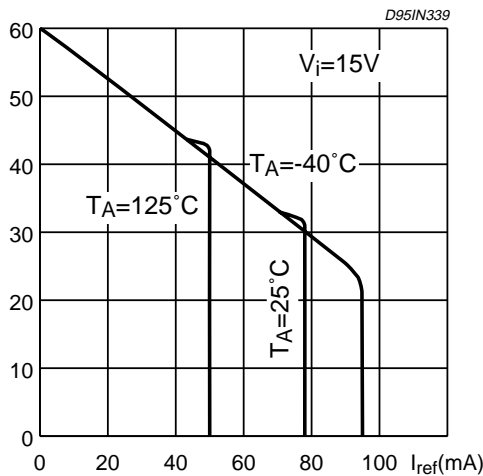

**Figure 9:** Reference Short Circuit Current vs. Temperature.

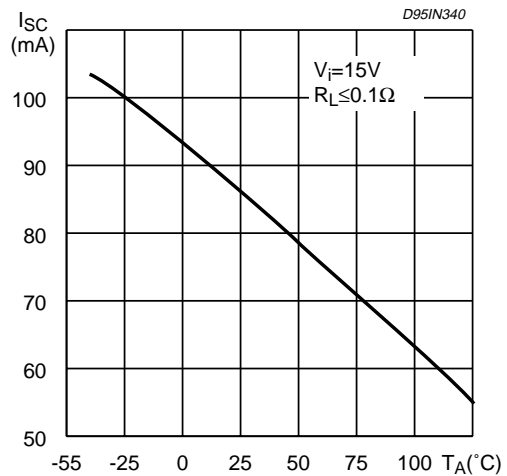

Figure 10: Output Saturation Voltages vs. Load Current.



Figure 12: Output Waveform.



Figure 14: Oscillator and Output Waveforms.



Figure 11: Supply Current vs. Supply Voltage.



Figure 13: Output Cross Conduction



Figure 15 : Error Amp Configuration.

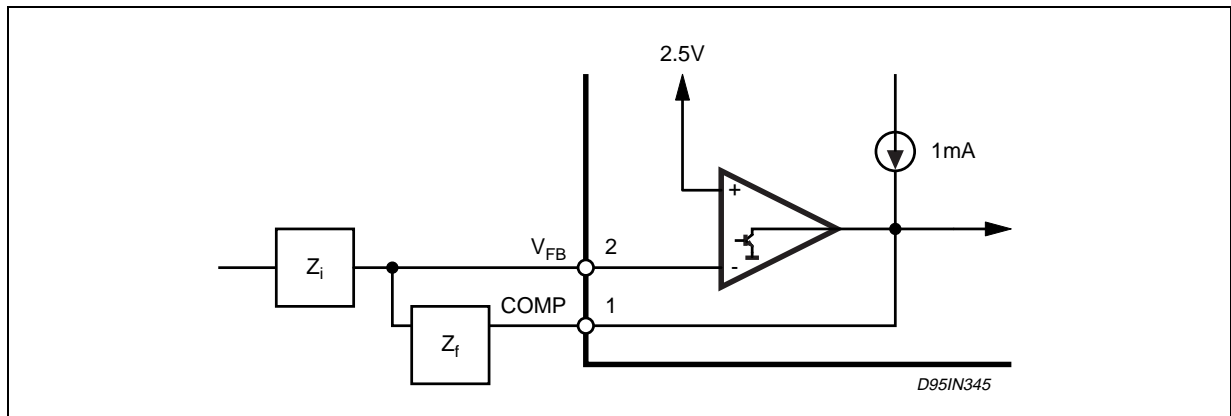

Figure 16 : Under Voltage Lockout.

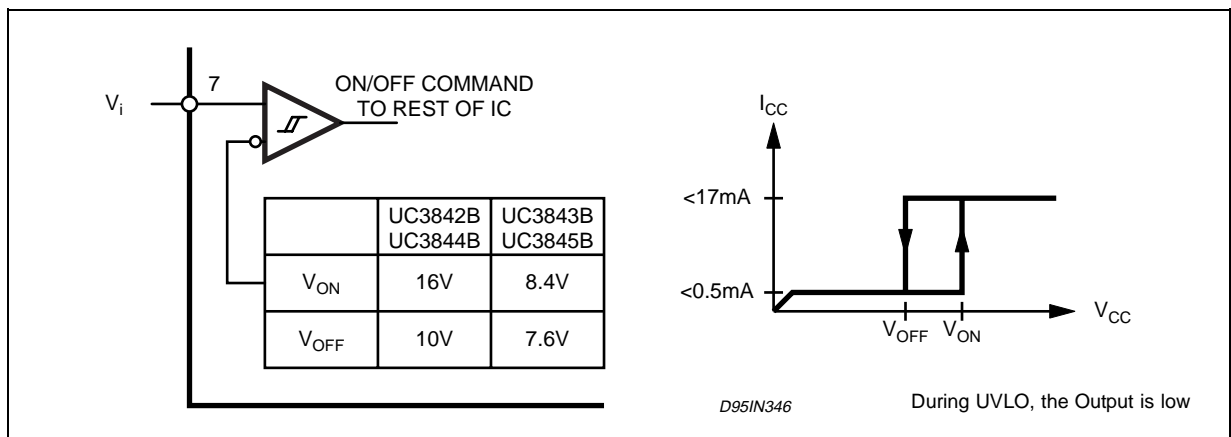

Figure 17 : Current Sense Circuit .



Peak current ( $i_s$ ) is determined by the formula

$$I_{s \max} \approx \frac{1.0 \text{ V}}{R_s}$$

A small RC filter may be required to suppress switch transients.





Figure 20 : Latched Shutdown.



Figure 21: Error Amplifier Compensation



Figure 22: External Clock Synchronization.



Figure 23: External Duty Cycle Clamp and Multi Unit Synchronization.





DIM.	mm			inch		
	MIN.	TYP.	MAX.	MIN.	TYP.	MAX.
A			1.75			0.069
a1	0.1		0.25	0.004		0.010
a2			1.65			0.065
a3	0.65		0.85	0.026		0.033
b	0.35		0.48	0.014		0.019
b1	0.19		0.25	0.007		0.010
C	0.25		0.5	0.010		0.020
c1	45° (typ.)					
D (1)	4.8		5.0	0.189		0.197
E	5.8		6.2	0.228		0.244
e		1.27			0.050	
e3		3.81			0.150	
F (1)	3.8		4.0	0.15		0.157
L	0.4		1.27	0.016		0.050
M			0.6			0.024
S	8° (max.)					

**OUTLINE AND MECHANICAL DATA**



**SO8**

(1) D and F do not include mold flash or protrusions. Mold flash or protrusions shall not exceed 0.15mm (.006inch).



UC2842B/3B/4B/5B - UC3842B/3B/4B/5B

DIM.	mm			inch		
	MIN.	TYP.	MAX.	MIN.	TYP.	MAX.
A		3.32			0.131	
a1	0.51			0.020		
B	1.15		1.65	0.045		0.065
b	0.356		0.55	0.014		0.022
b1	0.204		0.304	0.008		0.012
D			10.92			0.430
E	7.95		9.75	0.313		0.384
e		2.54			0.100	
e3		7.62			0.300	
e4		7.62			0.300	
F			6.6			0.260
I			5.08			0.200
L	3.18		3.81	0.125		0.150
Z			1.52			0.060

OUTLINE AND MECHANICAL DATA



Minidip



Information furnished is believed to be accurate and reliable. However, STMicroelectronics assumes no responsibility for the consequences of use of such information nor for any infringement of patents or other rights of third parties which may result from its use. No license is granted by implication or otherwise under any patent or patent rights of STMicroelectronics. Specification mentioned in this publication are subject to change without notice. This publication supersedes and replaces all information previously supplied. STMicroelectronics products are not authorized for use as critical components in life support devices or systems without express written approval of STMicroelectronics.

The ST logo is a registered trademark of STMicroelectronics  
© 1999 STMicroelectronics – Printed in Italy – All Rights Reserved  
STMicroelectronics GROUP OF COMPANIES

Australia - Brazil - Canada - China - France - Germany - Italy - Japan - Korea - Malaysia - Malta - Mexico - Morocco - The Netherlands -  
Singapore - Spain - Sweden - Switzerland - Taiwan - Thailand - United Kingdom - U.S.A.

<http://www.st.com>