



General Description

The AO4423/AO4423L uses advanced trench technology to provide excellent $R_{DS(ON)}$, and ultra-low low gate charge with a 25V gate rating. This device is suitable for use as a load switch or in PWM applications.

* RoHS and Halogen-Free Compliant

Product Summary

V_{DS} (V) = -30V
 I_D = -17A (V_{GS} = -20V)
 $R_{DS(ON)} < 6.2m\Omega$ (V_{GS} = -20V)
 $R_{DS(ON)} < 7.2m\Omega$ (V_{GS} = -10V)

ESD Protected
 100% UIS tested
 100% Rg tested (note *)

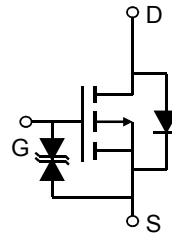
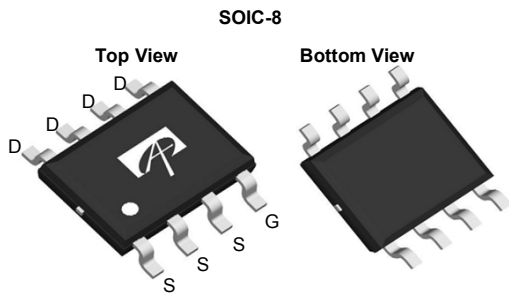

Absolute Maximum Ratings $T_A=25^\circ\text{C}$ unless otherwise noted

Parameter	Symbol	Maximum	Units
Drain-Source Voltage	V_{DS}	-30	V
Gate-Source Voltage	V_{GS}	± 25	V
Continuous Drain Current ^{AF}	I_D	$T_A=25^\circ\text{C}$	-17
		$T_A=70^\circ\text{C}$	-14
Pulsed Drain Current ^B	I_{DM}	-182	A
Power Dissipation ^A	P_D	$T_A=25^\circ\text{C}$	3.1
		$T_A=70^\circ\text{C}$	2
Junction and Storage Temperature Range	T_J, T_{STG}	-55 to 150	$^\circ\text{C}$

Thermal Characteristics

Parameter	Symbol	Typ	Max	Units
Maximum Junction-to-Ambient ^{AF}	$R_{\theta JA}$	$t \leq 10s$	26	$^\circ\text{C/W}$
Maximum Junction-to-Ambient ^A		Steady-State	50	$^\circ\text{C/W}$
Maximum Junction-to-Lead ^C	$R_{\theta JL}$	14	24	$^\circ\text{C/W}$

Electrical Characteristics (T_J=25°C unless otherwise noted)

Symbol	Parameter	Conditions	Min	Typ	Max	Units
STATIC PARAMETERS						
BV _{DSS}	Drain-Source Breakdown Voltage	I _D =-250μA, V _{GS} =0V	-30			V
I _{DSS}	Zero Gate Voltage Drain Current	V _{DS} =-30V, V _{GS} =0V T _J =55°C			-1 -5	μA
I _{GSS}	Gate-Body leakage current	V _{DS} =0V, V _{GS} =±20V			±1	μA
		V _{DS} =0V, V _{GS} =±25V			±10	μA
V _{GS(th)}	Gate Threshold Voltage	V _{DS} =V _{GS} I _D =-250μA	-1.5	-2.1	-2.6	V
I _{D(ON)}	On state drain current	V _{GS} =-10V, V _{DS} =-5V	-182			A
R _{DS(ON)}	Static Drain-Source On-Resistance	V _{GS} =-20V, I _D =-15A T _J =125°C		5.1 7.4	6.2 9	mΩ
		V _{GS} =-10V, I _D =-15A		5.9	7.2	mΩ
		V _{GS} =-6V, I _D =-10A		7.5	9.5	mΩ
g _{FS}	Forward Transconductance	V _{DS} =-5V, I _D =-15A		48		S
V _{SD}	Diode Forward Voltage	I _S =-1A, V _{GS} =0V		-0.71	-1	V
I _S	Maximum Body-Diode Continuous Current				-4.2	A
DYNAMIC PARAMETERS						
C _{iss}	Input Capacitance	V _{GS} =0V, V _{DS} =-15V, f=1MHz		2527	3033	pF
C _{oss}	Output Capacitance			583		pF
C _{rss}	Reverse Transfer Capacitance			397	556	pF
R _g	Gate resistance	V _{GS} =0V, V _{DS} =0V, f=1MHz	2.1	4.3	6.4	Ω
SWITCHING PARAMETERS						
Q _g	Total Gate Charge	V _{GS} =-10V, V _{DS} =-15V, I _D =-15A		47	57	nC
Q _{gs}	Gate Source Charge			8		nC
Q _{gd}	Gate Drain Charge			14		nC
t _{D(on)}	Turn-On DelayTime	V _{GS} =-10V, V _{DS} =-15V, R _L =1.0Ω, R _{GEN} =3Ω		12		ns
t _r	Turn-On Rise Time			8		ns
t _{D(off)}	Turn-Off DelayTime			54		ns
t _f	Turn-Off Fall Time			87		ns
t _{rr}	Body Diode Reverse Recovery Time	I _F =-15A, dI/dt=100A/μs		26.1	32	ns
Q _{rr}	Body Diode Reverse Recovery Charge	I _F =-15A, dI/dt=100A/μs		12.3		nC

A: The value of R_{θJA} is measured with the device mounted on 1in 2 FR-4 board with 2oz. Copper, in a still air environment with T_A=25° C. The value in any given application depends on the user's specific board design.

B: Repetitive rating, pulse width limited by junction temperature.

C: The R_{θJA} is the sum of the thermal impedance from junction to lead R_{θJL} and lead to ambient.

D: The static characteristics in Figures 1 to 6 are obtained using <300 μs pulses, duty cycle 0.5% max.

E: These tests are performed with the device mounted on 1 in 2 FR-4 board with 2oz. Copper, in a still air environment with T_A=25° C. The SOA curve provides a single pulse rating.

F: The current rating is based on the t ≤ 10s junction to ambient thermal resistance rating.

Note *: This device is guaranteed RG 100% tested after date code 8V11 (Jan 1st 2008)

APPLICATIONS OR USE AS CRITICAL COMPONENTS IN LIFE SUPPORT DEVICES OR SYSTEMS ARE NOT AUTHORIZED. AOS DOES NOT ASSUME ANY LIABILITY ARISING OUT OF SUCH APPLICATIONS OR USES OF ITS PRODUCTS. AOS RESERVES THE RIGHT TO IMPROVE PRODUCT DESIGN,FUNCTIONS AND RELIABILITY WITHOUT NOTICE.

TYPICAL ELECTRICAL AND THERMAL CHARACTERISTICS

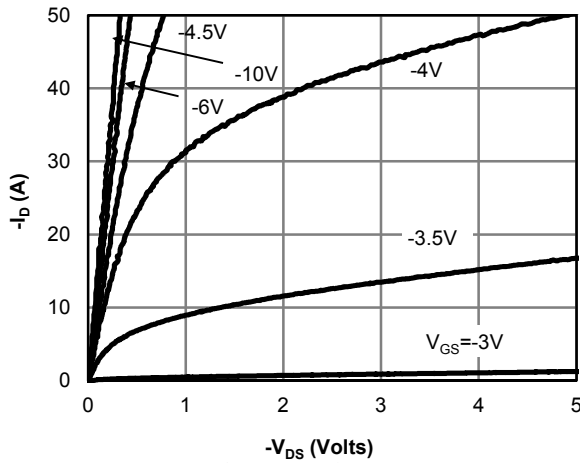

Fig 1: On-Region Characteristics

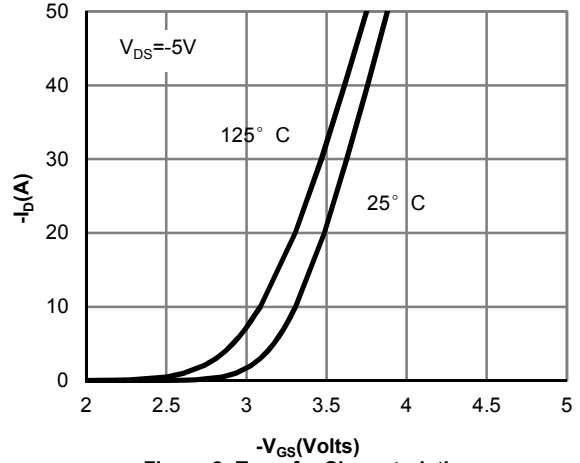

Figure 2: Transfer Characteristics

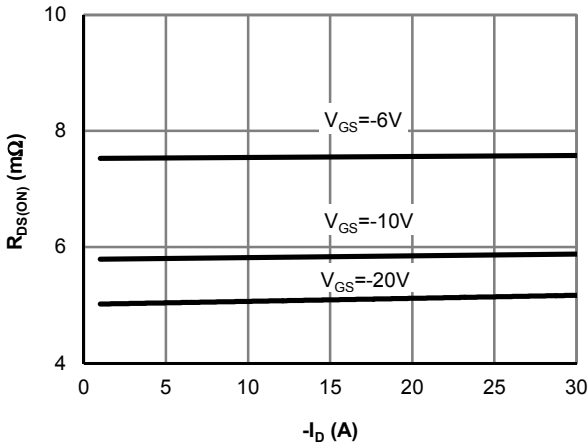

Figure 3: On-Resistance vs. Drain Current and Gate Voltage

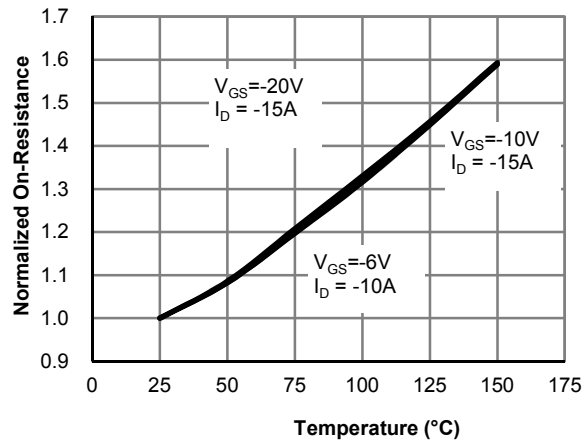

Figure 4: On-Resistance vs. Junction Temperature

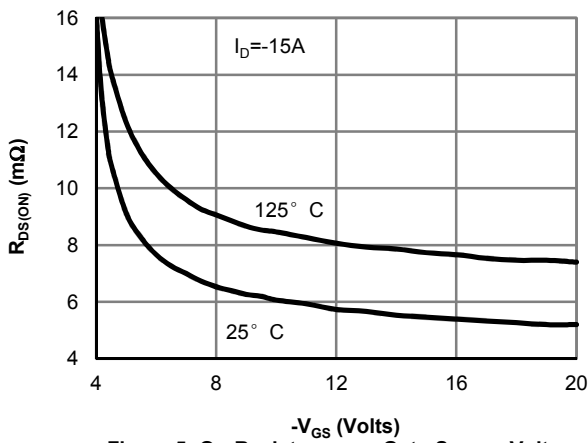

Figure 5: On-Resistance vs. Gate-Source Voltage

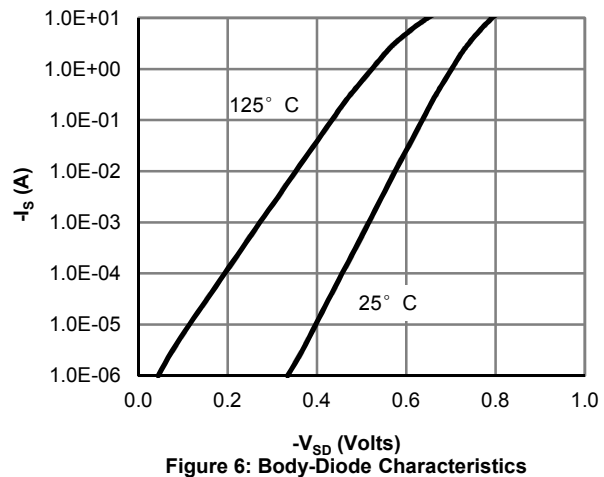

Figure 6: Body-Diode Characteristics

TYPICAL ELECTRICAL AND THERMAL CHARACTERISTICS

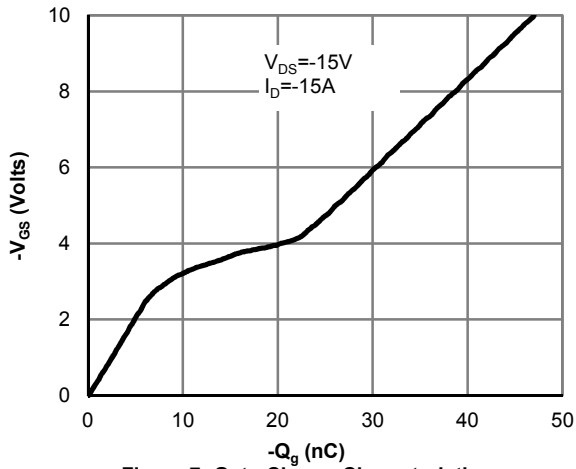

Figure 7: Gate-Charge Characteristics

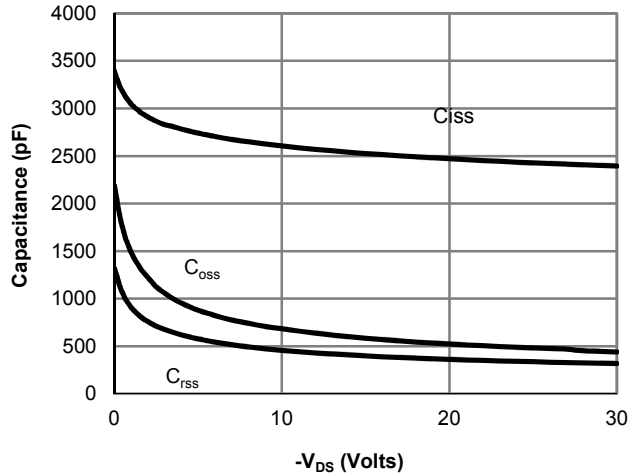

Figure 8: Capacitance Characteristics

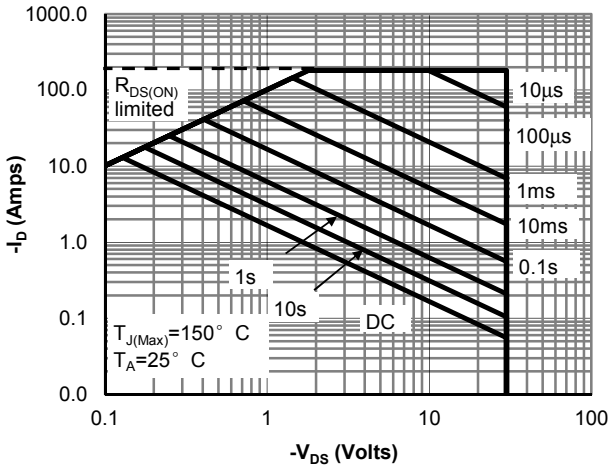

Figure 9: Maximum Forward Biased Safe

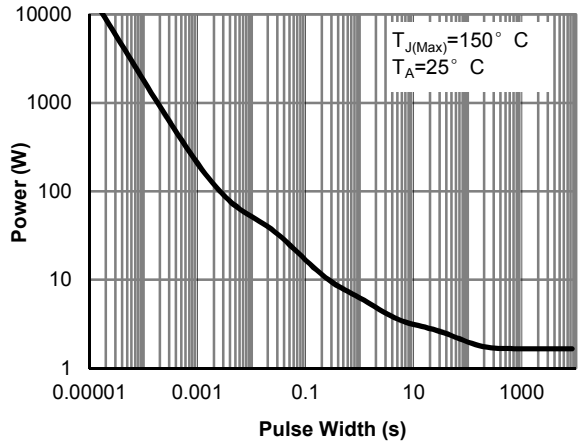

Figure 10: Single Pulse Power Rating Junction-to-Ambient (Note E)

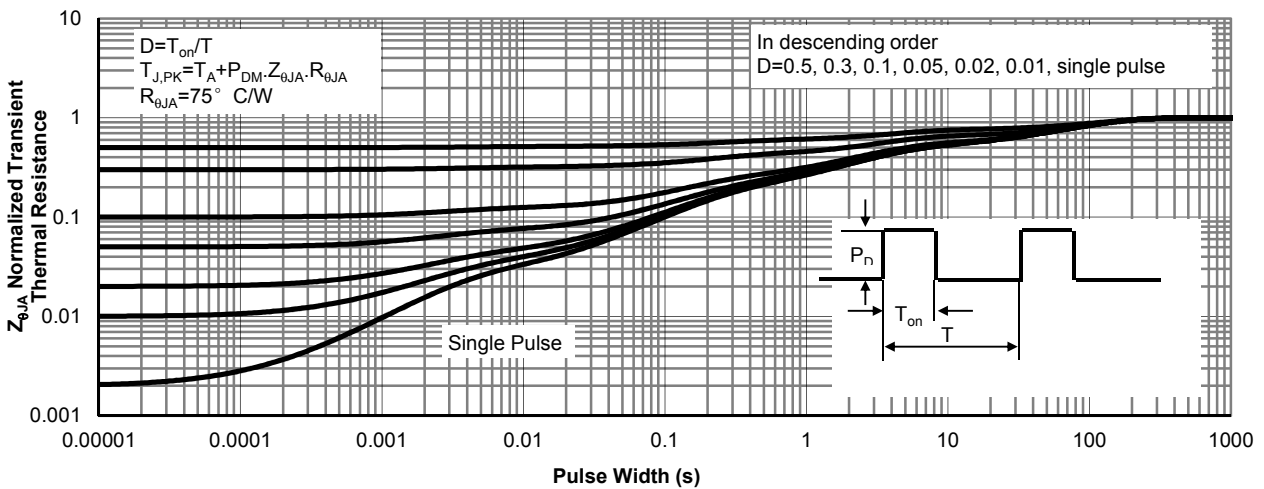
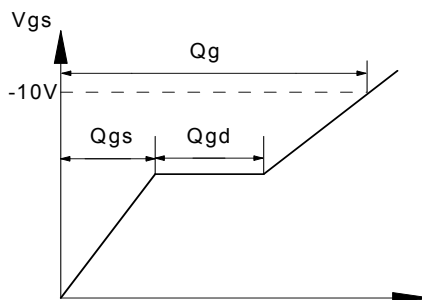
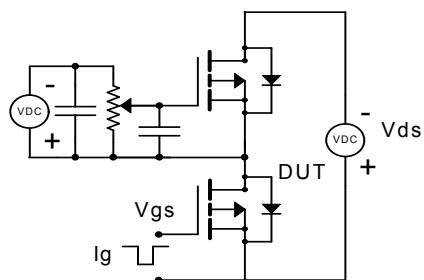
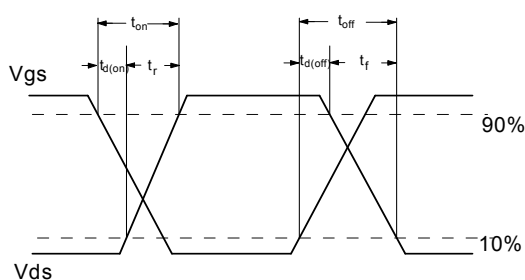
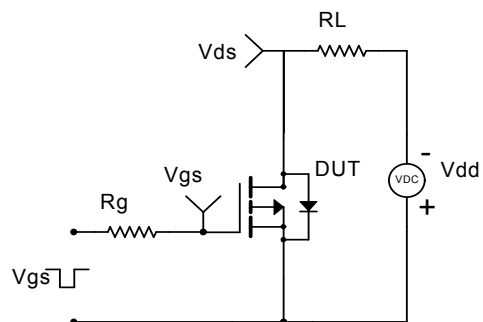

Figure 11: Normalized Maximum Transient Thermal Impedance

Gate Charge Test Circuit & Waveform



Resistive Switching Test Circuit & Waveforms



Unclamped Inductive Switching (UIS) Test Circuit & Waveforms

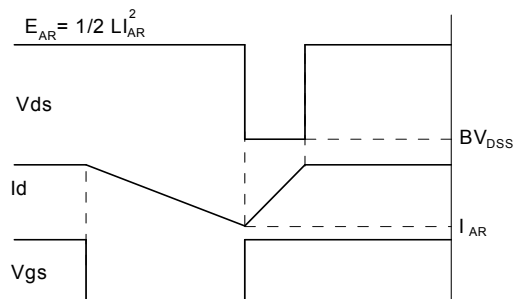
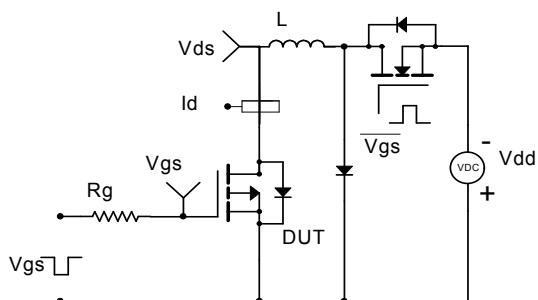

Diode Recovery Test Circuit & Waveforms

