



Typical Applications

The HMC199MS8 / 199MS8E is ideal for:

- Cellular
- ISM Basestations
- PCS

Features

- RoHS-Compliant Product
- Integrated Dual SPDTs
- Low Insertion Loss: <0.5 dB @ 2 GHz
- Positive Control: 0/+5V
- Ultra Small MSOP8 Package: 14.8 mm²

Functional Diagram

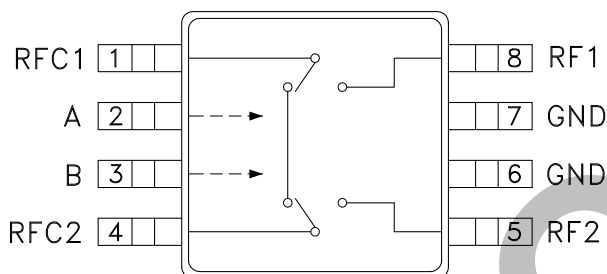

General Description

The HMC199MS8 & HMC199MS8E are low-cost general purpose dual SPDT GaAs “bypass” switches in 8-lead MSOP packages covering DC to 2.5 GHz. These four-RF- port components integrate two SPDT switches and a through line onto a single IC. The designs provide low insertion loss of less than 0.5 dB while switching passive or active external circuit components in and out of the signal path. Port to port isolations are typically 25 to 30 dB. On-chip circuitry enables positive voltage control operation at very low DC currents with control inputs compatible with CMOS and most TTL logic families. Applications include LNA or filter bypass switching and single bit attenuator switching. The HMC199MS8E is a RoHS-compliant product.

Electrical Specifications, $T_A = +25^\circ\text{C}$, $V_{ctl} = 0/+5\text{Vdc}$, 50 Ohm System

Parameter	Frequency	Min.	Typ.	Max.	Units
Insertion Loss	DC - 1.0 GHz		0.3	0.6	dB
	DC - 2.0 GHz		0.5	0.8	dB
	DC - 2.5 GHz		0.7	1.0	dB
Isolation	DC - 2.0 GHz	22	25		dB
	DC - 2.5 GHz	17	21		dB
Return Loss (On State, Any Port)	DC - 2.0 GHz	17	20		dB
	DC - 2.5 GHz	12	15		dB
Input Power for 1 dB Compression	0.5 - 2.0 GHz	19	23		dBm
Input Third Order Intercept (Two-tone Input Power = 0 dBm Each Tone)	0.5 - 2.0 GHz	32	36		dBm
Switching Characteristics	DC - 2.5 GHz				
		tRISE, tFALL (10/90% RF)		20	ns
		tON, tOFF (50% CTL to 10/90% RF)		40	ns



Insertion Loss

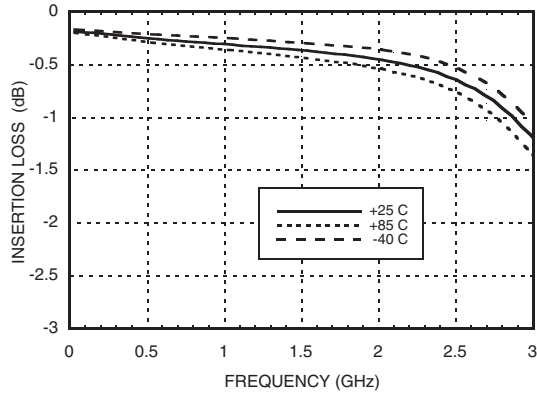

Isolation

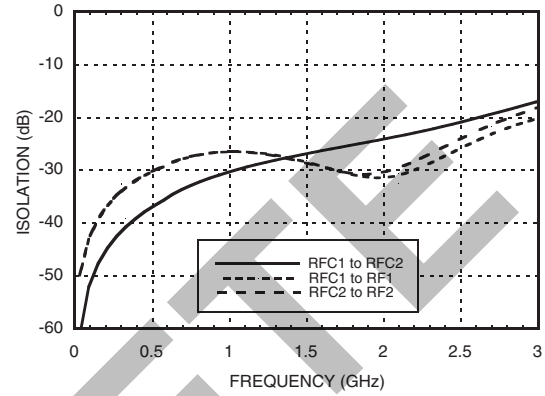

Return Loss

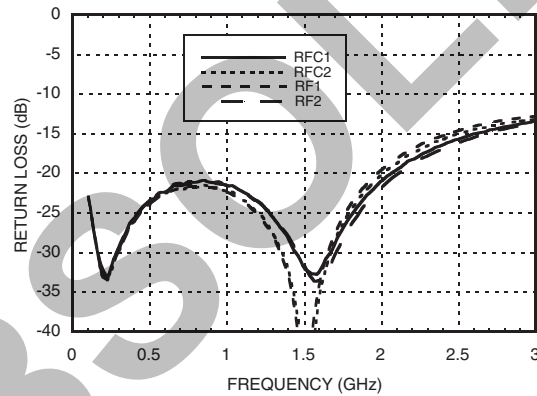

Note:

Isolation between RF1 - RF2 (when RFC1 - RFC2 is in insertion loss state) is 25 dB @ 1 GHz and 17 dB @ 2 GHz.

Information furnished by Analog Devices is believed to be accurate and reliable. However, no responsibility is assumed by Analog Devices for its use, nor for any infringements of patents or other rights of third parties that may result from its use. Specifications subject to change without notice. No license is granted by implication or otherwise under any patent or patent rights of Analog Devices. Trademarks and registered trademarks are the property of their respective owners.

For price, delivery, and to place orders: Analog Devices, Inc., One Technology Way, P.O. Box 9106, Norwood, MA 02062-9106 Phone: 781-329-4700 • Order online at www.analog.com Application Support: Phone: 1-800-ANALOG-D



Compression vs. Frequency

CTL Input	Carrier at 900MHz		Carrier at 1900MHz	
	Input Power for 0.1 dB Compression	Input Power for 1.0 dB Compression	Input Power for 0.1 dB Compression	Input Power for 1.0 dB Compression
	(Vdc)	(dBm)	(dBm)	(dBm)
+5	20	23.5	19	22

Caution: Do not operate continuously at RF power input greater than 1 dB compression and do not "hot switch" power levels greater than +13 dBm (Control = 0/+5Vdc).

Distortion vs. Frequency

Control Input (Vdc)	Input Third Order Intercept (dBm) 0 dBm Each Tone	
	900 MHz	1900 MHz
+5	34.5	37.5

Truth Table

*Control Input Tolerances are +/- 0.5 Vdc

Control Input*		Control Current (Typical)		Signal Path		
A (Vdc)	B (Vdc)	Ia (uA)	Ib (uA)	RFC1 to RFC2	RFC1 to RF1	RFC2 to RF2
0	+5	-65	65	ON	OFF	OFF
+5	0	65	-65	OFF	ON	ON

DC blocking capacitors are required at ports RFC1, RFC2, RF1, RF2. Choose value for lowest frequency of operation.



Absolute Maximum Ratings

RF Input Power $V_{CTL} = 0/+5V$	+24 dBm
Control Voltage Range (A & B)	-0.5 to +7.5 Vdc
Channel Temperature	150 °C
Thermal Resistance	172 °C/W
Storage Temperature	-65 to +150 °C
Operating Temperature	-40 to +85 °C
ESD Sensitivity (HBM)	Class 1A



Outline Drawing

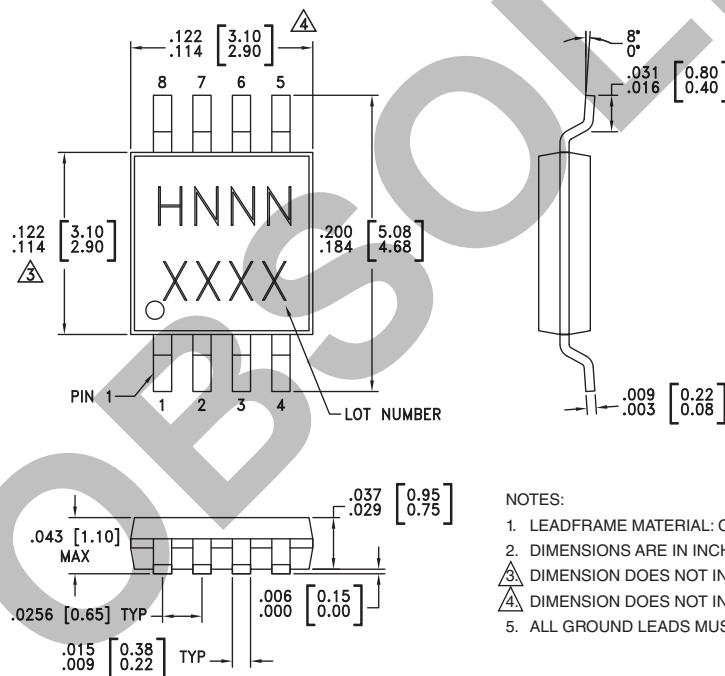

NOTES:

- LEADFRAME MATERIAL: COPPER ALLOY
- DIMENSIONS ARE IN INCHES [MILLIMETERS].
- DIMENSION DOES NOT INCLUDE MOLDFLASH OF 0.15mm PER SIDE.
- DIMENSION DOES NOT INCLUDE MOLDFLASH OF 0.25mm PER SIDE.
- ALL GROUND LEADS MUST BE SOLDERED TO PCB RF GROUND.

Package Information

Part Number	Package Body Material	Lead Finish	MSL Rating	Package Marking ^[3]
HMC199MS8	Low Stress Injection Molded Plastic	Sn/Pb Solder	MSL1 ^[1]	H199 XXXX
HMC199MS8E	RoHS-compliant Low Stress Injection Molded Plastic	100% matte Sn	MSL1 ^[2]	H199 XXXX

[1] Max peak reflow temperature of 235 °C

[2] Max peak reflow temperature of 260 °C

[3] 4-Digit lot number XXXX



Typical Application Circuit

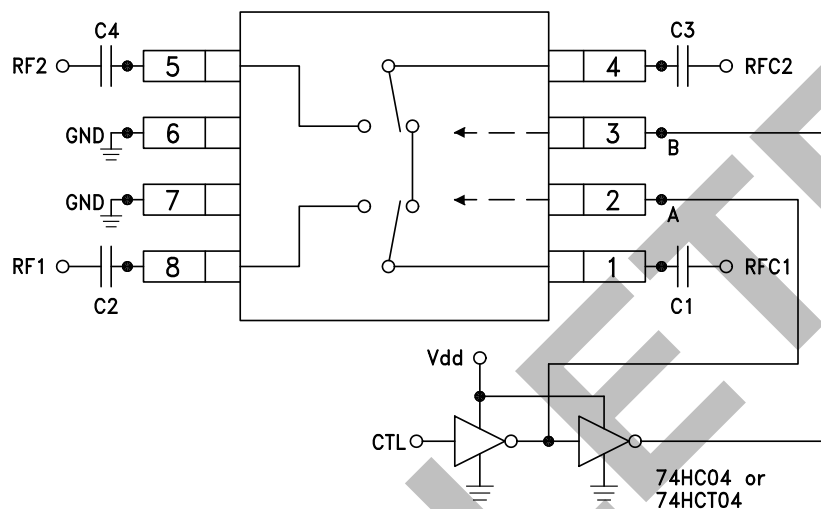

Notes:

1. Set A/B control to 0/+5V, Vdd = +5V and use HCT series logic to provide a TTL driver interface.
2. Control inputs A/B can be driven directly with CMOS logic (HC) with Vdd = 5 to 7 Volts applied to the CMOS logic gates.
3. DC Blocking capacitors are required for each RF port as shown. Capacitor value determines lowest frequency of operation.
4. Highest RF signal power capability is achieved with Vdd = +7V and A/B set to 0/+7V.
5. For further information refer to "Using the HMC199MS8 as a Low-Cost 1-Bit Attenuator" product note.



Eval Board Layout (Top View)

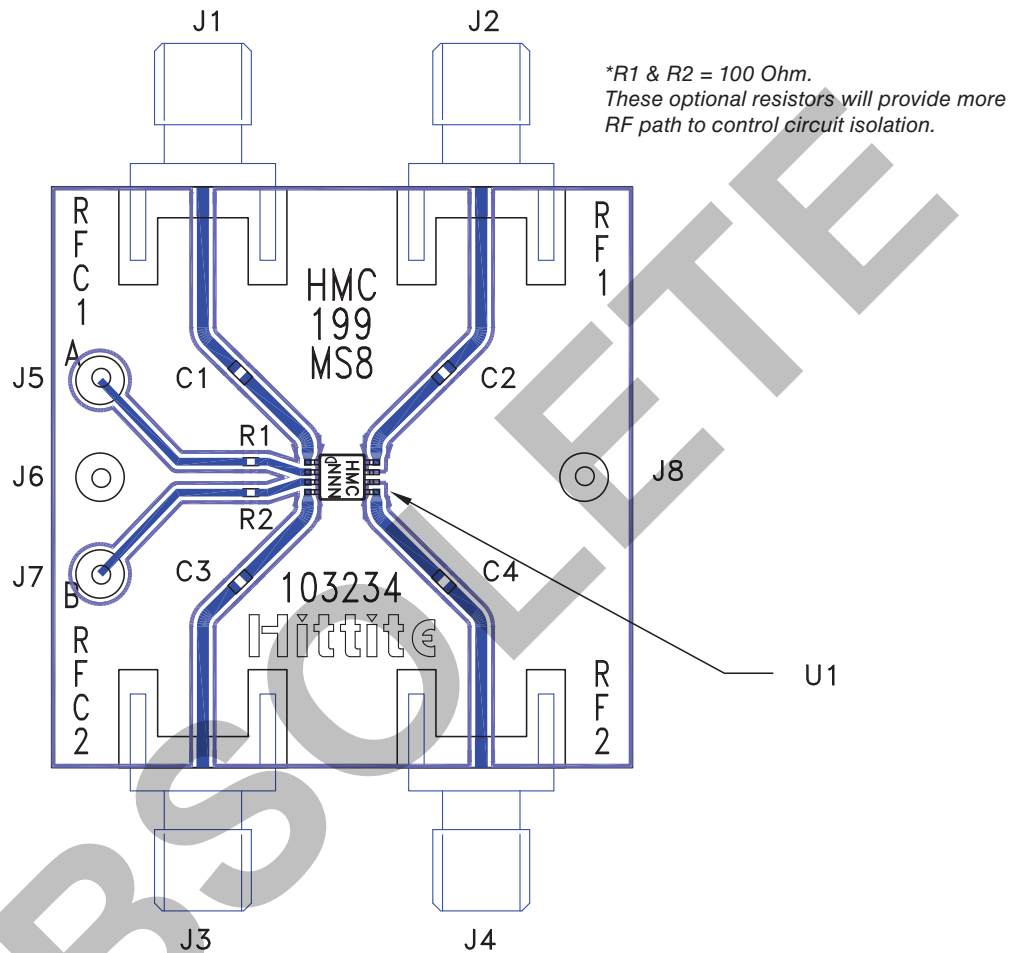

List of Materials for Evaluation PCB 103236 [1]

Item	Description
J1 - J4	PCB Mount SMA RF Connector
J5 - J8	DC Pin
C1 - C4	Chip Capacitor, 0402 Pkg. Choose value for lowest frequency of operation. 330 pF is provided on PCB.
R1 - R2	100 Ohm Resistor, 0402 Pkg.
U1	HMC199MS8 / HMC199MS8E Bypass Switch
PCB [2]	103234 Evaluation PCB 1.5" x 1.5"

[1] Reference this number when ordering complete evaluation PCB

[2] Circuit Board Material: Rogers 4350

The circuit board used in the final application should be generated with proper RF circuit design techniques. Signal lines at the RF ports should have 50 ohm impedance. The evaluation circuit board shown above is available from Hittite Microwave Corporation upon request.