



Typical Applications

The HMC182S14 / HMC182S14E is ideal for:

- 800 - 1000 MHz Basestation

Features

- Low Insertion Loss: 0.8dB
- Integrated 2:4 Decoder
- 14 Lead SOIC Package

Functional Diagram

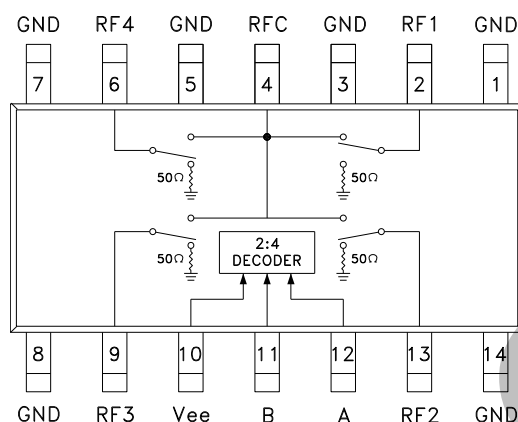

General Description

The HMC182S14 & HMC182S14E are low-cost terminated SP4T switches in 14-lead SOIC packages for use in antenna diversity, switched filter banks, gain/attenuation selection, and general channel multiplexing applications. The switch can control signals up to 2 GHz. A 2:4 decoder is integrated on the switch, requiring only 2 control lines and a negative bias to select each RF path. The 2:4 decoder replaces 4 to 8 control lines normally required by GaAs SP4T switches. The HMC182S14(E) are drop-in replacements for the HMC165S14 in applications requiring low "off state" VSWR. See positive bias / TTL SP4T HMC241QS16.

Electrical Specifications,

$T_A = +25^\circ\text{C}$, For 0/-5V Control and Vee = -5V in a 50 Ohm System

Parameter	Frequency	Min.	Typ.	Max.	Units
Insertion Loss	DC - 1.0 GHz		0.7	1.1	dB
	DC - 2.0 GHz		0.8	1.2	dB
Isolation	DC - 0.5 GHz	41	45		dB
	DC - 1.0 GHz	36	40		dB
	DC - 2.0 GHz	28	32		dB
Return Loss	"On State" DC - 1.0 GHz	21	25		dB
	"On State" DC - 2.0 GHz	16	20		dB
	"Off State" DC - 1.0 GHz	17	21		dB
	"Off State" DC - 2.0 GHz	13	17		dB
Input Power for 1 dB Compression	50 MHz		22		dBm
	0.5 - 2.0 GHz		24		dBm
Input Third Order Intercept (Two-Tone Input Power = 7 dBm Each Tone).	50 MHz	25	30		dBm
	0.5 - 1.0 GHz	41	45		dBm
	0.5 - 2.0 GHz	37	41		dBm
Switching Characteristics	DC - 2.0 GHz	tRISE, tFALL (10/90% RF)	25		ns
		tON, tOFF (50% CTL to 10/90% RF)	50		ns

Information furnished by Analog Devices is believed to be accurate and reliable. However, no responsibility is assumed by Analog Devices for its use, nor for any infringements of patents or other rights of third parties that may result from its use. Specifications subject to change without notice. No license is granted by implication or otherwise under any patent or patent rights of Analog Devices. Trademarks and registered trademarks are the property of their respective owners.

For price, delivery, and to place orders: Analog Devices, Inc., One Technology Way, P.O. Box 9106, Norwood, MA 02062-9106 Phone: 781-329-4700 • Order online at www.analog.com Application Support: Phone: 1-800-ANALOG-D



Insertion Loss

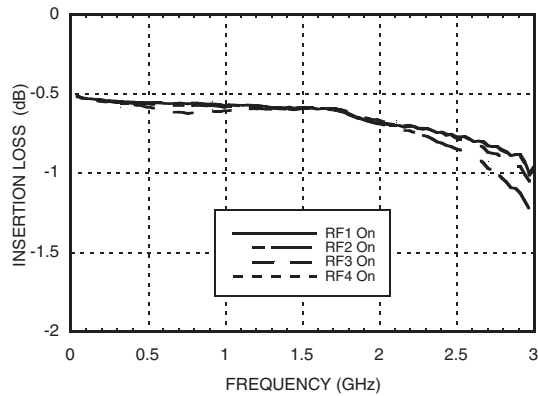

Isolation

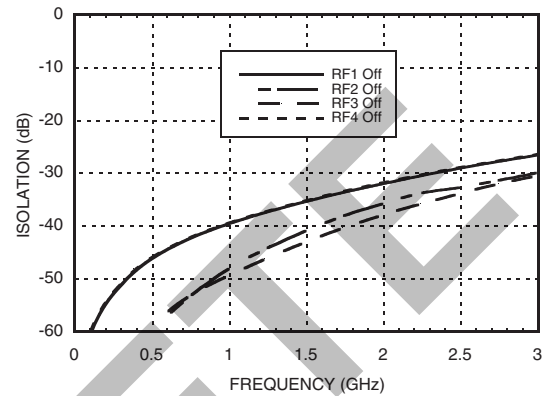

Return Loss

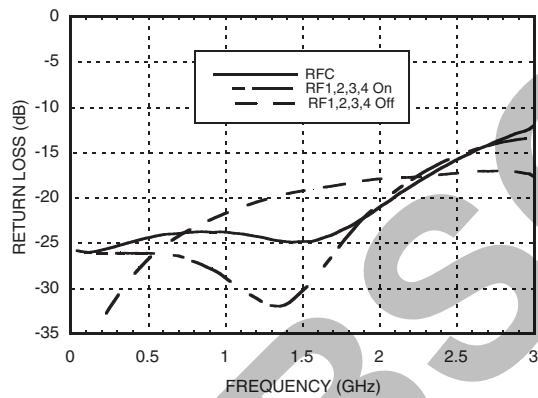

Isolation Between Several RF I/Os

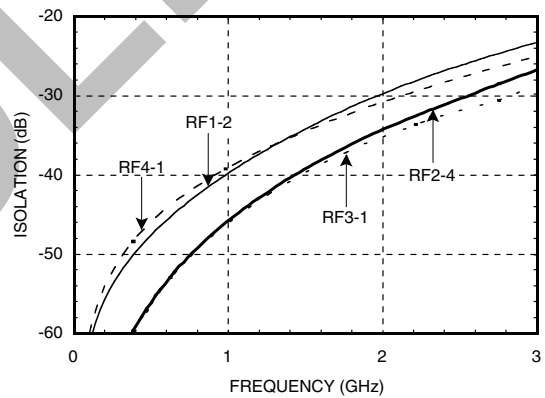

Bias Voltage & Current

Vee Range = -5.0 Vdc ± 10%		
Vee (Vdc)	Iee (Typ.) (mA)	Iee (Max.) (mA)
-5.0	4.0	7.0

Truth Table

Control Input		Signal Path State
A	B	RFCOM to:
High	High	RF1
Low	High	RF2
High	Low	RF3
Low	Low	RF4

Control Voltages

State	Bias Condition
Low	0 to -3 VDC @ 70 uA Typ.
High	-5 to -4.2 VDC @ 5 uA Typ.

Information furnished by Analog Devices is believed to be accurate and reliable. However, no responsibility is assumed by Analog Devices for its use, nor for any infringements of patents or other rights of third parties that may result from its use. Specifications subject to change without notice. No license is granted by implication or otherwise under any patent or patent rights of Analog Devices. Trademarks and registered trademarks are the property of their respective owners.

For price, delivery, and to place orders: Analog Devices, Inc., One Technology Way, P.O. Box 9106, Norwood, MA 02062-9106 Phone: 781-329-4700 • Order online at www.analog.com Application Support: Phone: 1-800-ANALOG-D



Absolute Maximum Ratings

Bias Voltage Range (Port Vee)	-7 Vdc
Control Voltage Range (A & B)	Vee -0.5V to +1.0 Vdc
Channel Temperature	150 °C
Thermal Resistance (Insertion Loss Path)	123 °C/W
Thermal Resistance (Terminated Path)	260 °C/W
Storage Temperature	-65 to +150 °C
Operating Temperature	-40 to +85 °C
Maximum Input Power	+27 dBm (<500 MHz) +30 dBm (>500 MHz)



ELECTROSTATIC SENSITIVE DEVICE
OBSERVE HANDLING PRECAUTIONS

10

SWITCHES - SMT

Outline Drawing

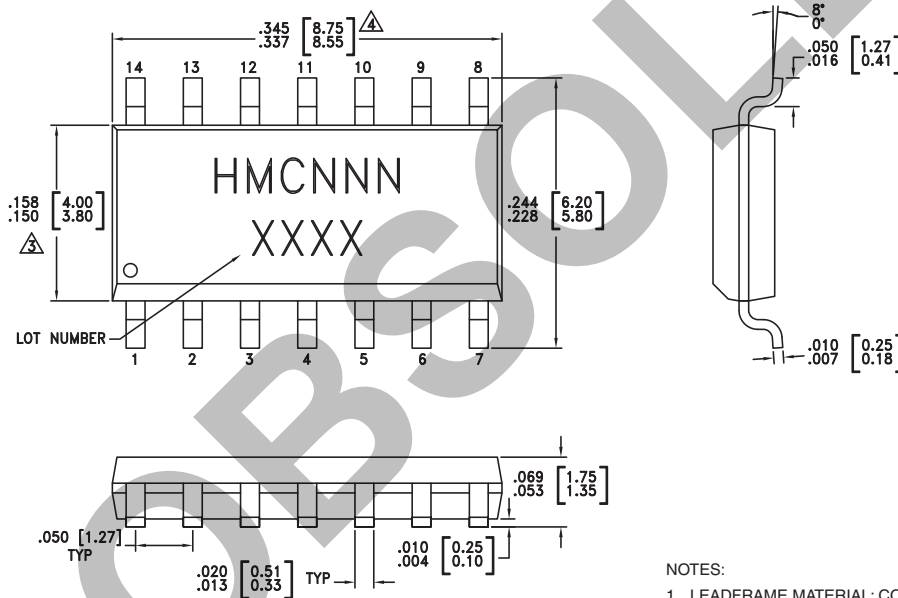

NOTES:

- LEADFRAME MATERIAL: COPPER ALLOY
- DIMENSIONS ARE IN INCHES [MILLIMETERS].
- \triangle DIMENSION DOES NOT INCLUDE MOLDFLASH OF 0.15mm PER SIDE.
- \triangle DIMENSION DOES NOT INCLUDE MOLDFLASH OF 0.25mm PER SIDE.
- ALL GROUND LEADS MUST BE SOLDERED TO PCB RF GROUND.

Package Information

Part Number	Package Body Material	Leadframe Plating	MSL Rating	Package Marking ^[3]
HMC182S14	Low Stress Injection Molding Plastic Silica and Silicon Impregnated	Sn/Pb Solder	MSL1 ^[1]	HMC182 XXXX
HMC182S14E	RoHS-compliant Low Stress Injection Molding Plastic Silica and Silicon Impregnated	100% Matte Tin	MSL1 ^[2]	HMC182 XXXX

[1] Max peak reflow temperature of 235 °C

[2] Max peak reflow temperature of 260 °C

[3] 4-Digit lot number XXXX

TTL Interface Circuit

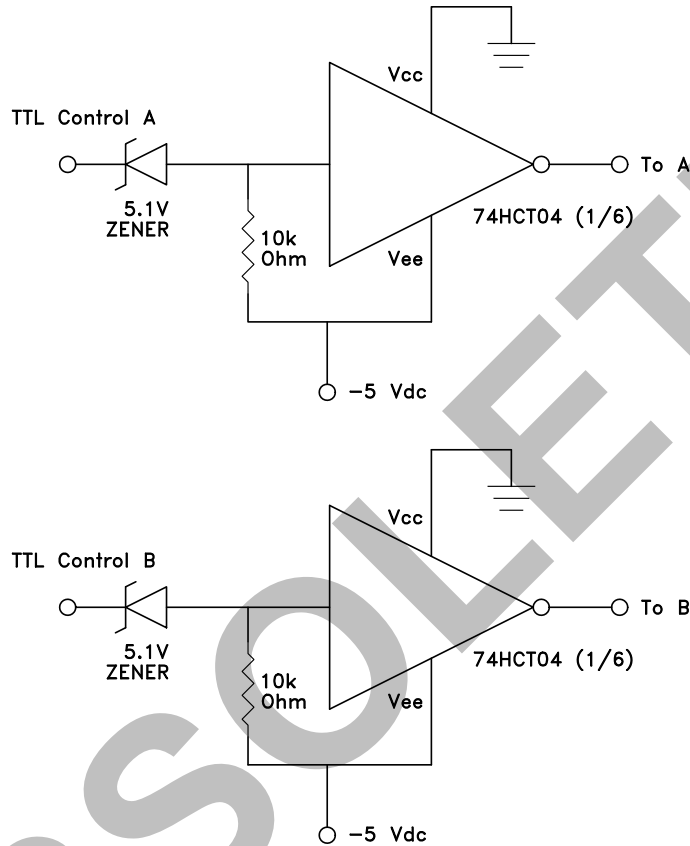

Note:
Control inputs A and B can be driven directly with TTL logic with -5 Volts applied to the HCT logic gate Vee pin and to Vee (pin 10) of the RF switch.

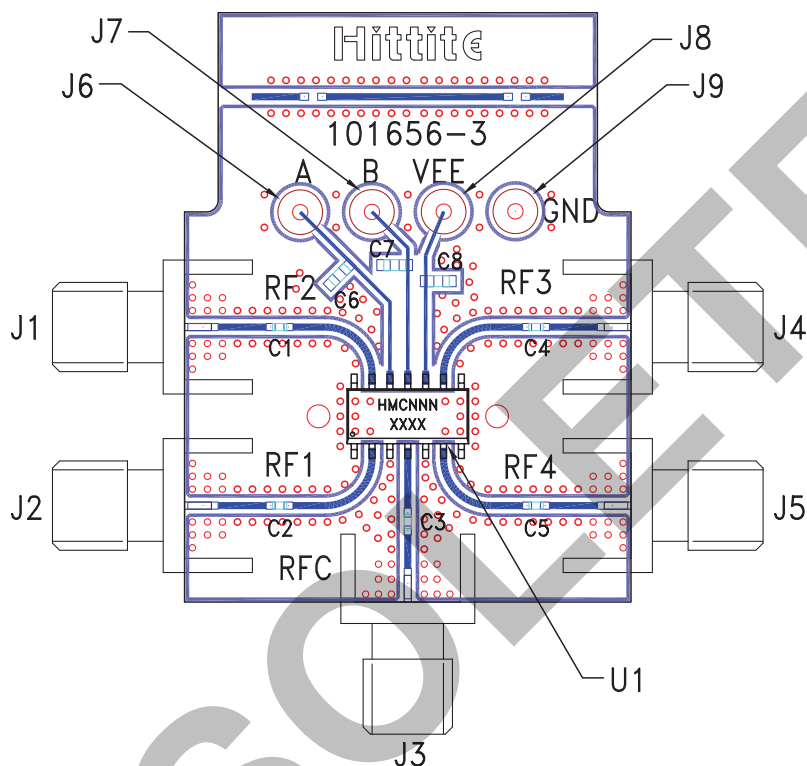
Evaluation PCB

List of Materials for Evaluation PCB 101672 [1]

Item	Description
J1 - J5	PCB Mount SMA RF Connector
J6 - J9	DC Pin
C1 - C5	330 pF capacitor, 0402 Pkg.
C6 - C8	10,000 pF capacitor, 0603 Pkg.
U1	HMC182S14 / HMC182S14E SP4T Switch
PCB [2]	101656 Evaluation PCB

[1] Reference this number when ordering complete evaluation PCB

[2] Circuit Board Material: Rogers 4350

The circuit board used in the final application should be generated with proper RF circuit design techniques. Signal lines at the RF port should have 50 ohm impedance and the package ground leads should be connected directly to the ground plane similar to that shown above. The evaluation circuit board shown above is available from Hittite Microwave Corporation upon request.



HMC182S14 / 182S14E

v03.0805

**GaAs MMIC SP4T NON-REFLECTIVE
SWITCH, DC - 2 GHz**



Notes:

OBSOLETE

10

SWITCHES - SMT