

# Surface Mount Ultrafast Power Rectifiers

**MURS320T3G, SURS8320T3G,  
SURS8320T3G-VF01,  
MURS340T3G, SURS8340T3G,  
MURS360T3G, SURS8360T3G,  
SURS8360T3G-VF01**

**ULTRAFAST  
RECTIFIERS  
3.0 AMPERES  
200–600 VOLTS**



SMC 2-LEAD  
CASE 403AC

## MARKING DIAGRAM

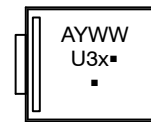

U3 = Specific Device Code  
x = D (320T3)  
= G (340T3)  
= J (360T3)  
A = Assembly Location\*\*  
Y = Year  
WW = Work Week

\*\*The Assembly Location code (A) is front side optional. In cases where the Assembly Location is stamped in the package, the front side assembly code may be blank.

This series employs the state-of-the-art epitaxial construction with oxide passivation and metal overlay contact. Ideally suited for high voltage, high frequency rectification, or as free wheeling and protection diodes, in surface mount applications where compact size and weight are critical to the system.

### Features

- Small Compact Surface Mountable Package with J-Bend Leads
- Rectangular Package for Automated Handling
- High Temperature Glass Passivated Junction
- Low Forward Voltage Drop  
(0.71 to 1.05 Volts Max @ 3.0 A, T<sub>J</sub> = 150°C)
- SURS8 Prefix for Automotive and Other Applications Requiring Unique Site and Control Change Requirements; AEC-Q101 Qualified and PPAP Capable\*
- These Devices are Pb-Free, Halogen Free/BFR Free and are RoHS Compliant

### Mechanical Characteristics

- Case: Epoxy, Molded
- Epoxy Meets UL 94 V-0 @ 0.125 in
- Weight: 217 mg (approximately)
- Finish: All External Surfaces Corrosion Resistant and Terminal Leads are Readily Solderable
- Lead and Mounting Surface Temperature for Soldering Purposes: 260°C Max. for 10 Seconds
- Shipped in 16 mm Tape and Reel, 2500 units per reel
- Polarity: Polarity Band on Plastic Body Indicates Cathode Lead
- Device Meets MSL1 Requirements
- ESD Ratings:
  - ◆ Human Body Model, 3B (> 8 kV)
  - ◆ Charged Device Model, > 1000 V (Class C5)

## ORDERING INFORMATION

Device	Package	Shipping†
MURS320T3G	SMC (Pb-Free)	2,500 / Tape & Reel
MURS340T3G	SMC (Pb-Free)	2,500 / Tape & Reel
MURS360T3G	SMC (Pb-Free)	2,500 / Tape & Reel
SURS8320T3G*, SURS8320T3G-VF01*	SMC (Pb-Free)	2,500 / Tape & Reel
SURS8340T3G*	SMC (Pb-Free)	2,500 / Tape & Reel
SURS8360T3G, SURS8360T3G-VF01*	SMC (Pb-Free)	2,500 / Tape & Reel

†For information on tape and reel specifications, including part orientation and tape sizes, please refer to our Tape and Reel Packaging Specifications Brochure, BRD8011/D.

**MURS320T3G, SURS8320T3G, SURS8320T3G-VF01, MURS340T3G, SURS8340T3G,  
MURS360T3G, SURS8360T3G, SURS8360T3G-VF01**

**MAXIMUM RATINGS**

Rating	Symbol	MURS320T3G/ SURS8320T3G/ SURS8320T3G-VF01	MURS340T3G/ SURS8340T3G	MURS360T3G/ SURS8360T3G/ SURS8360T3G-VF01	Unit
Peak Repetitive Reverse Voltage Working Peak Reverse Voltage DC Blocking Voltage	$V_{RRM}$ $V_{RWM}$ $V_R$	200	400	600	V
Average Rectified Forward Current	$I_{F(AV)}$	3.0 @ $T_L = 140^\circ\text{C}$ 4.0 @ $T_L = 130^\circ\text{C}$	3.0 @ $T_L = 130^\circ\text{C}$ 4.0 @ $T_L = 115^\circ\text{C}$	3.0 @ $T_L = 130^\circ\text{C}$ 4.0 @ $T_L = 115^\circ\text{C}$	A
Non-Repetitive Peak Surge Current (Surge applied at rated load conditions halfwave, single phase, 60 Hz)	$I_{FSM}$	100			A
Operating Junction Temperature	$T_J$	- 65 to +175			$^\circ\text{C}$

Stresses exceeding those listed in the Maximum Ratings table may damage the device. If any of these limits are exceeded, device functionality should not be assumed, damage may occur and reliability may be affected.

**THERMAL CHARACTERISTICS**

Thermal Resistance, Junction-to-Lead	$R_{\theta JL}$	11	$^\circ\text{C}/\text{W}$
--------------------------------------	-----------------	----	---------------------------

**ELECTRICAL CHARACTERISTICS**

Maximum Instantaneous Forward Voltage (Note 1) ( $i_F = 3.0\text{ A}$ , $T_J = 25^\circ\text{C}$ ) ( $i_F = 4.0\text{ A}$ , $T_J = 25^\circ\text{C}$ ) ( $i_F = 3.0\text{ A}$ , $T_J = 150^\circ\text{C}$ )	$V_F$	0.875 0.89 0.71	1.25 1.28 1.05	1.25 1.28 1.05	V
Maximum Instantaneous Reverse Current (Note 1) (Rated dc Voltage, $T_J = 25^\circ\text{C}$ ) (Rated dc Voltage, $T_J = 150^\circ\text{C}$ )	$i_R$	5.0 150	10 250	10 250	$\mu\text{A}$
Maximum Reverse Recovery Time ( $i_F = 1.0\text{ A}$ , $di/dt = 50\text{ A}/\mu\text{s}$ ) ( $i_F = 0.5\text{ A}$ , $i_R = 1.0\text{ A}$ , $I_{REC}$ to 0.25 A)	$t_{rr}$	35 25	75 50	75 50	ns
Maximum Forward Recovery Time ( $i_F = 1.0\text{ A}$ , $di/dt = 100\text{ A}/\mu\text{s}$ , Recovery to 1.0 V)	$t_{fr}$	25	50	50	ns
Typical Peak Reverse Recovery Current ( $i_F = 1.0\text{ A}$ , $di/dt = 50\text{ A}/\mu\text{s}$ )	$I_{RM}$	0.8			A

Product parametric performance is indicated in the Electrical Characteristics for the listed test conditions, unless otherwise noted. Product performance may not be indicated by the Electrical Characteristics if operated under different conditions.

1. Pulse Test: Pulse Width = 300  $\mu\text{s}$ , Duty Cycle  $\leq 2.0\%$ .

MURS320T3G, SURS8320T3G, SURS8320T3G-VF01, MURS340T3G, SURS8340T3G, MURS360T3G, SURS8360T3G, SURS8360T3G-VF01

MURS320T3G/SURS8320T3G/SURS8320T3G-VF01

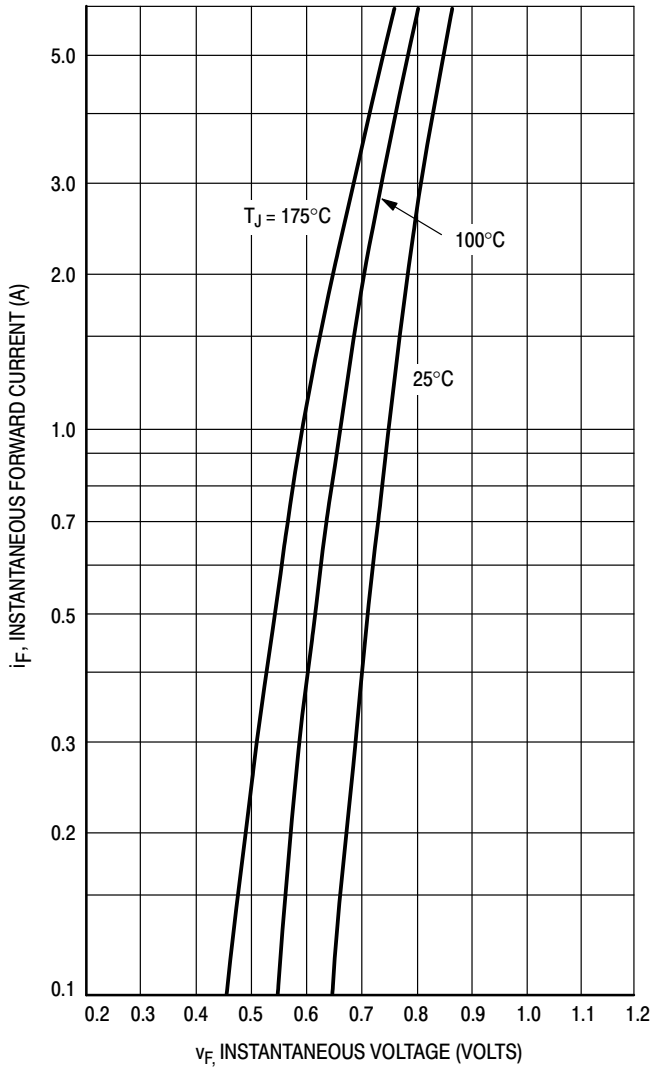

Figure 1. Typical Forward Voltage

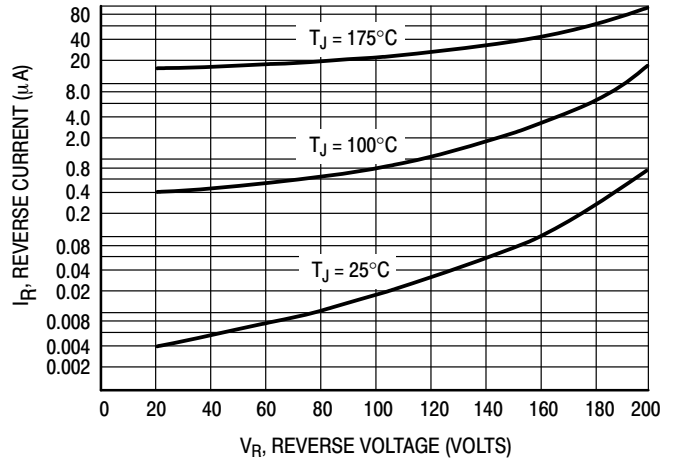

Figure 2. Typical Reverse Current\*

\* The curves shown are typical for the highest voltage device in the voltage grouping. Typical reverse current for lower voltage selections can be estimated from these same curves if  $V_R$  is sufficiently below rated  $V_R$ .

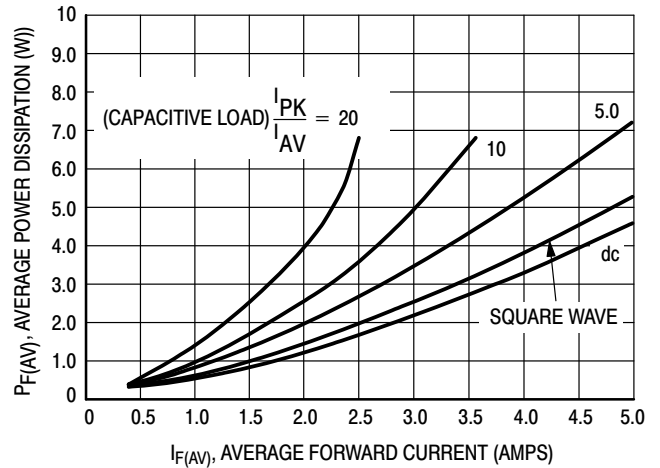

Figure 3. Power Dissipation

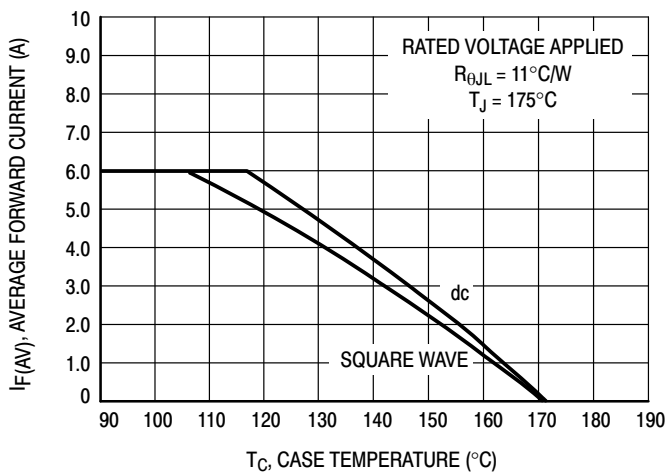

Figure 4. Current Derating, Case

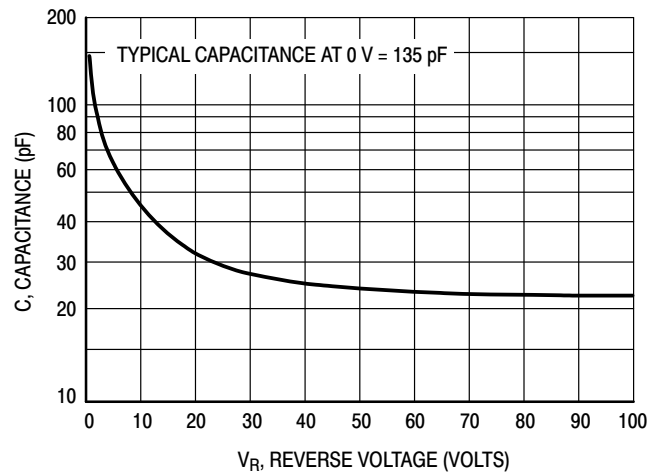

Figure 5. Typical Capacitance

MURS320T3G, SURS8320T3G, SURS8320T3G-VF01, MURS340T3G, SURS8340T3G, MURS360T3G, SURS8360T3G, SURS8360T3G-VF01

TYPICAL CHARACTERISTICS

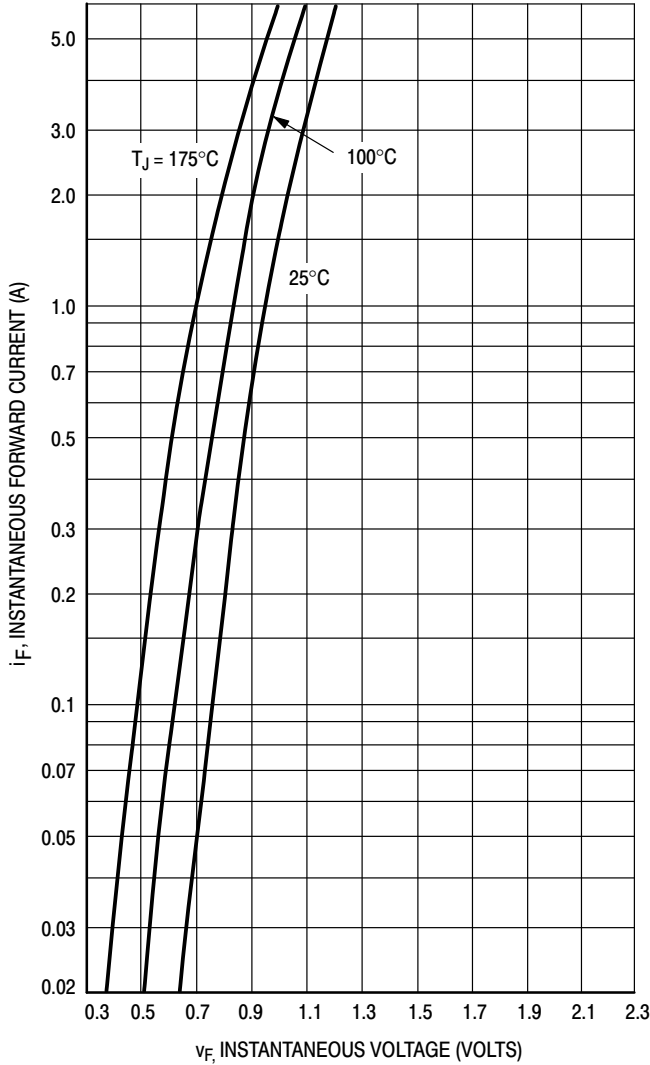

Figure 6. Typical Forward Voltage

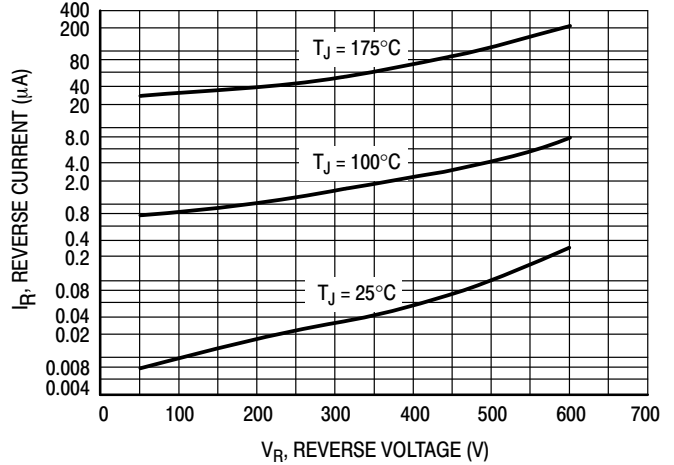

Figure 7. Typical Reverse Current\*

\* The curves shown are typical for the highest voltage device in the voltage grouping. Typical reverse current for lower voltage selections can be estimated from these same curves if  $V_R$  is sufficiently below rated  $V_R$ .

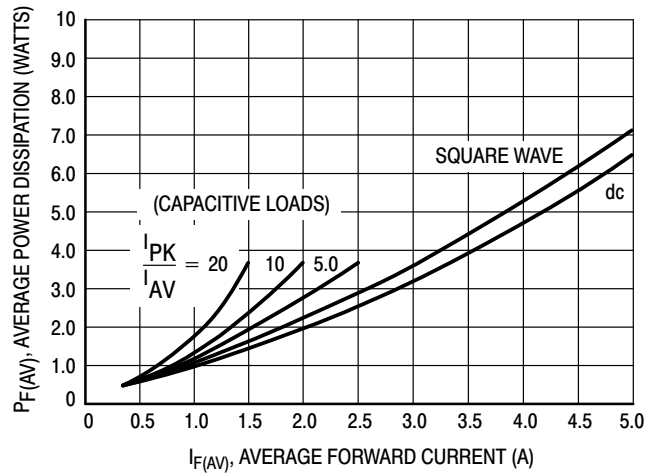

Figure 8. Power Dissipation

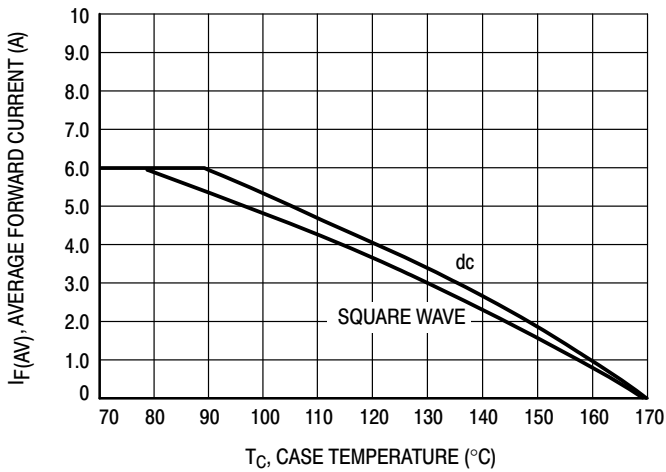

Figure 9. Current Derating, Case

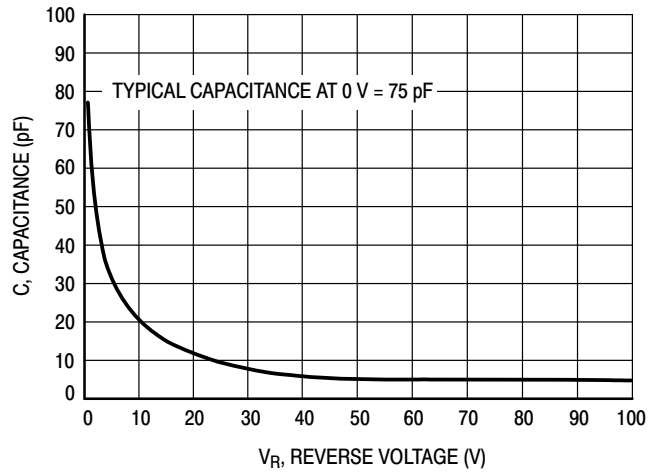
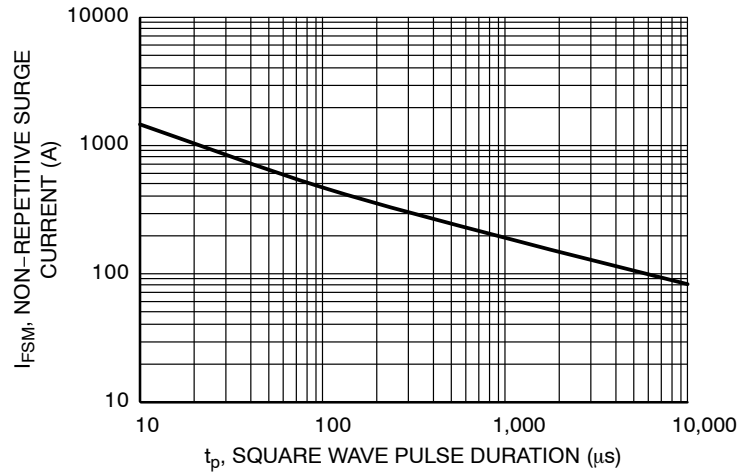

Figure 10. Typical Capacitance

MURS320T3G, SURS8320T3G, SURS8320T3G-VF01, MURS340T3G, SURS8340T3G,  
MURS360T3G, SURS8360T3G, SURS8360T3G-VF01

MURS320T3G, SURS8320T3G, SURS8320T3G-VF01, MURS340T3G, SURS8340T3G, MURS360T3G,  
SURS8360T3G, SURS8360T3G-VF01



**Figure 11. Typical Non-Repetitive Surge Current**

\*Typical performance based on a limited sample size. **onsemi** does not guarantee ratings not listed in the Maximum Ratings table.

# MECHANICAL CASE OUTLINE

## PACKAGE DIMENSIONS

ON Semiconductor®



SCALE 1:1

### SMC 2-LEAD CASE 403AC ISSUE B

DATE 27 JUL 2017

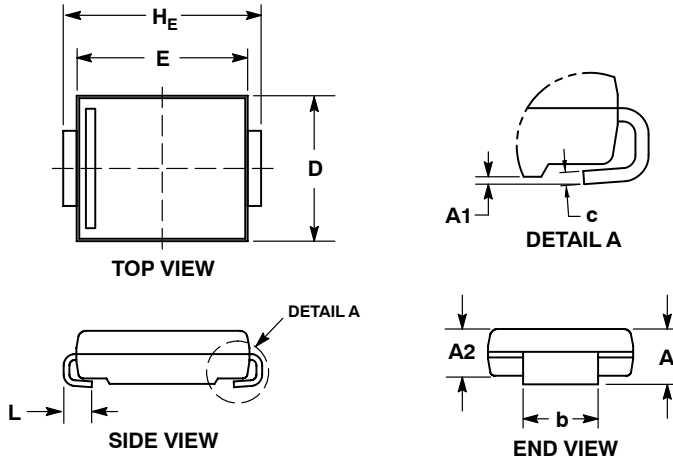

NOTES:

1. DIMENSIONING AND TOLERANCING PER ANME Y14.5M, 1994.
2. CONTROLLING DIMENSION: INCHES.
3. DIMENSIONS D AND E DO NOT INCLUDE MOLD FLASH. MOLD FLASH SHALL NOT EXCEED 0.254mm PER SIDE.
4. DIMENSIONS D AND E TO BE DETERMINED AT DATUM H.
5. DIMENSION b SHALL BE MEASURED WITHIN THE AREA DETERMINED BY DIMENSION L.

DIM	MILLIMETERS		INCHES	
	MIN	MAX	MIN	MAX
A	1.95	2.61	0.077	0.103
A1	0.05	0.20	0.002	0.008
A2	1.90	2.41	0.075	0.095
b	2.90	3.20	0.114	0.126
c	0.15	0.41	0.006	0.016
D	5.55	6.25	0.219	0.246
E	6.60	7.15	0.260	0.281
HE	7.75	8.15	0.305	0.321
L	0.75	1.60	0.030	0.063

### GENERIC MARKING DIAGRAM\*



- XXXX = Specific Device Code
- A = Assembly Location
- Y = Year
- WW = Work Week
- = Pb-Free Package

(Note: Microdot may be in either location)

\*This information is generic. Please refer to device data sheet for actual part marking. Pb-Free indicator, "G" or microdot "■", may or may not be present.

### RECOMMENDED SOLDERING FOOTPRINT\*

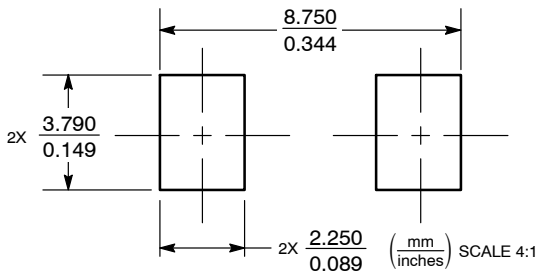

\*For additional information on our Pb-Free strategy and soldering details, please download the ON Semiconductor Soldering and Mounting Techniques Reference Manual, SOLDERRM/D.

<b>DOCUMENT NUMBER:</b>	<b>98AON97675F</b>	Electronic versions are uncontrolled except when accessed directly from the Document Repository. Printed versions are uncontrolled except when stamped "CONTROLLED COPY" in red.
<b>DESCRIPTION:</b>	<b>SMC 2-LEAD</b>	<b>PAGE 1 OF 1</b>

ON Semiconductor and are trademarks of Semiconductor Components Industries, LLC dba ON Semiconductor or its subsidiaries in the United States and/or other countries. ON Semiconductor reserves the right to make changes without further notice to any products herein. ON Semiconductor makes no warranty, representation or guarantee regarding the suitability of its products for any particular purpose, nor does ON Semiconductor assume any liability arising out of the application or use of any product or circuit, and specifically disclaims any and all liability, including without limitation special, consequential or incidental damages. ON Semiconductor does not convey any license under its patent rights nor the rights of others.

**onsemi**, **Onsemi**, and other names, marks, and brands are registered and/or common law trademarks of Semiconductor Components Industries, LLC dba "**onsemi**" or its affiliates and/or subsidiaries in the United States and/or other countries. **onsemi** owns the rights to a number of patents, trademarks, copyrights, trade secrets, and other intellectual property. A listing of **onsemi**'s product/patent coverage may be accessed at [www.onsemi.com/site/pdf/Patent-Marking.pdf](http://www.onsemi.com/site/pdf/Patent-Marking.pdf). **onsemi** reserves the right to make changes at any time to any products or information herein, without notice. The information herein is provided "as-is" and **onsemi** makes no warranty, representation or guarantee regarding the accuracy of the information, product features, availability, functionality, or suitability of its products for any particular purpose, nor does **onsemi** assume any liability arising out of the application or use of any product or circuit, and specifically disclaims any and all liability, including without limitation special, consequential or incidental damages. Buyer is responsible for its products and applications using **onsemi** products, including compliance with all laws, regulations and safety requirements or standards, regardless of any support or applications information provided by **onsemi**. "Typical" parameters which may be provided in **onsemi** data sheets and/or specifications can and do vary in different applications and actual performance may vary over time. All operating parameters, including "Typicals" must be validated for each customer application by customer's technical experts. **onsemi** does not convey any license under any of its intellectual property rights nor the rights of others. **onsemi** products are not designed, intended, or authorized for use as a critical component in life support systems or any FDA Class 3 medical devices or medical devices with a same or similar classification in a foreign jurisdiction or any devices intended for implantation in the human body. Should Buyer purchase or use **onsemi** products for any such unintended or unauthorized application, Buyer shall indemnify and hold **onsemi** and its officers, employees, subsidiaries, affiliates, and distributors harmless against all claims, costs, damages, and expenses, and reasonable attorney fees arising out of, directly or indirectly, any claim of personal injury or death associated with such unintended or unauthorized use, even if such claim alleges that **onsemi** was negligent regarding the design or manufacture of the part. **onsemi** is an Equal Opportunity/Affirmative Action Employer. This literature is subject to all applicable copyright laws and is not for resale in any manner.

## PUBLICATION ORDERING INFORMATION

### LITERATURE FULFILLMENT:

Email Requests to: [orderlit@onsemi.com](mailto:orderlit@onsemi.com)

**onsemi Website:** [www.onsemi.com](http://www.onsemi.com)

### TECHNICAL SUPPORT

**North American Technical Support:**  
Voice Mail: 1 800-282-9855 Toll Free USA/Canada  
Phone: 011 421 33 790 2910

**Europe, Middle East and Africa Technical Support:**

Phone: 00421 33 790 2910

For additional information, please contact your local Sales Representative