

FEATURES

Amplitude settling time: 200 ns typical
Wideband rejection: ≥ 30 dB
Single chip implementation
40-lead, 6 mm \times 6 mm, RoHS compliant LFCSP

APPLICATIONS

Test and measurement equipment
Military radar and electronic warfare (EW) systems
Video satellite (VSAT) communications

GENERAL DESCRIPTION

The ADMV8432 is a monolithic microwave integrated circuit (MMIC), tunable band-pass filter that features a user selectable pass-band frequency. The 3 dB filter bandwidth is $>17\%$ of the center frequency (f_{CENTER}). Additionally, f_{CENTER} can be varied between 16.6 GHz to 30.1 GHz by applying an analog tuning voltage between 0 V to 15 V. The usable pass band corner

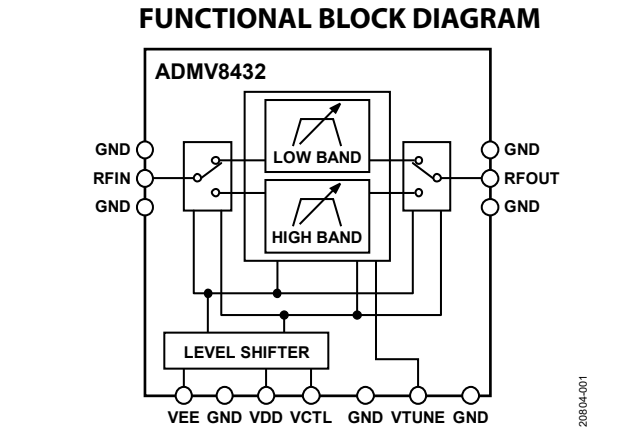

Figure 1.

frequencies (f_{CORNER}) span from 15.1 GHz to 32 GHz. This tunable filter can be used as a much smaller alternative to physically large switched filter banks and cavity tuned filters. This tunable filter has excellent microphonics due to the monolithic design and provides a dynamically adjustable solution in advanced communications applications.

TABLE OF CONTENTS

| | | | |
|--|---|---|----|
| Features | 1 | Interface Schematics | 7 |
| Applications..... | 1 | Typical Performance Characteristics | 8 |
| Functional Block Diagram | 1 | High Band | 8 |
| General Description | 1 | Low Band..... | 11 |
| Revision History | 2 | High Band and Low Band | 14 |
| Specifications..... | 3 | Theory of Operation | 15 |
| High Band Specifications | 3 | Applications Information | 16 |
| Low Band Specifications..... | 3 | Typical Application Circuit..... | 16 |
| DC Characteristics | 4 | Power Supply Sequence | 16 |
| Absolute Maximum Ratings..... | 5 | Outline Dimensions | 17 |
| ESD Caution..... | 5 | Ordering Guide | 17 |
| Pin Configuration and Function Descriptions..... | 6 | | |

REVISION HISTORY

3/2021—Rev. 0 to Rev. A

| | |
|--|----|
| Changes to Product Title and General Description..... | 1 |
| Changes to f_{CENTER} Parameter, Table 1 and 3 dB f_{CORNER} Parameter, Table 1..... | 3 |
| Changes to f_{CENTER} Parameter, Table 1 and 3 dB f_{CORNER} Parameter, Table 2..... | 3 |
| Changes to Theory of Operation..... | 15 |

7/2019—Revision 0: Initial Version

SPECIFICATIONS

HIGH BAND SPECIFICATIONS

T_A = 25°C, VDD = 5 V, VEE = -5 V, and VCTL = 0 V, unless otherwise noted.

Table 1.

| Parameter | Min | Typ | Max | Unit | Test Conditions/Comments |
|--|------|----------------------------|------|--------|---|
| FREQUENCY RANGE | | | | | |
| f _{CENTER} | 25.7 | | 30.1 | GHz | |
| 3 dB f _{CORNER} | 23.7 | | 32 | GHz | |
| 3 dB Filter Bandwidth | | 17 | | % | |
| REJECTION | | | | | |
| Low-Side | | 0.75 × f _{CENTER} | | GHz | ≥30 dB |
| High-Side | | 1.25 × f _{CENTER} | | GHz | ≥30 dB |
| Re-Entry | | >40 | | GHz | ≤30 dB |
| LOSS | | | | | |
| Insertion Loss | | 9 | | dB | |
| Return Loss | | 15 | | dB | |
| DYNAMIC PERFORMANCE | | | | | |
| Input Third-Order Intercept (IP3) | | 37 | | dBm | |
| Input Power at 5° Shift in Insertion Phase | | 19 | | dBm | VTUNE = 0 V |
| Group Delay Flatness | | 0.1 | | ns | VTUNE = 0 V |
| Phase Sensitivity | | 0.6 | | Rad/V | |
| Amplitude Settling | | 200 | | ns | Time to settle to minimum insertion loss, within ≤0.5 dB of static insertion loss |
| Drift Rate | | -2.7 | | MHz/°C | |
| Tuning Sensitivity | | 580 | | MHz/V | |
| RESIDUAL PHASE NOISE | | | | | |
| 1 MHz Offset | | -162 | | dBc/Hz | |

LOW BAND SPECIFICATIONS

T_A = 25°C, VDD = 5 V, VEE = -5 V, and VCTL = 2.5 V, unless otherwise noted.

Table 2.

| Parameter | Min | Typ | Max | Unit | Test Conditions/Comments |
|--------------------------|------|----------------------------|------|------|--------------------------|
| FREQUENCY RANGE | | | | | |
| f _{CENTER} | 16.6 | | 22.5 | GHz | |
| 3 dB f _{CORNER} | 15.1 | | 24.5 | GHz | |
| 3 dB Filter Bandwidth | | 18 | | % | |
| REJECTION | | | | | |
| Low-Side | | 0.72 × f _{CENTER} | | GHz | ≥30 dB |
| High-Side | | 1.21 × f _{CENTER} | | GHz | ≥30 dB |
| Re-Entry | | >40 | | GHz | ≤30 dB |
| LOSS | | | | | |
| Insertion Loss | | 8 | | dB | |
| Return Loss | | 10 | | dB | |

| Parameter | Min | Typ | Max | Unit | Test Conditions/Comments |
|--|-----|------|-----|--------|---|
| DYNAMIC PERFORMANCE | | | | | |
| Input IP3 | | 34 | | dBm | |
| Input Power at 5° Shift in Insertion Phase | | 20 | | dBm | VTUNE = 0 V |
| Group Delay Flatness | | 0.15 | | ns | VTUNE = 0 V |
| Phase Sensitivity | | 0.8 | | Rad/V | |
| Amplitude Settling | | 200 | | ns | Time to settle to minimum insertion loss, within ≤0.5 dB of static insertion loss |
| Drift Rate | | -1.4 | | MHz/°C | |
| Tuning Sensitivity | | 530 | | MHz/V | |
| RESIDUAL PHASE NOISE | | | | | |
| 1 MHz Offset | | -163 | | dBc/Hz | |

DC CHARACTERISTICS

Table 3.

| Parameter | Min | Typ | Max | Unit | Test Conditions/Comments |
|------------------------------------|------|-----|-----|------|---------------------------|
| f_{CENTER} TUNING | | | | | |
| Voltage (VTUNE) | 0 | | 15 | V | |
| Current (ITUNE) | | | ±1 | μA | |
| BAND CONTROL VOLTAGE (VCTL) | | | | | |
| Input Voltage | | | | | |
| Low | 0 | | 0.8 | V | 0 V for high band select |
| High | 2 | 2.5 | 3 | V | 2.5 V for low band select |
| Current | | | 1 | μA | |
| SUPPLY VOLTAGES | | | | | |
| Negative (VEE) | -5.5 | -5 | | V | |
| Positive (VDD) | | 5 | 5.5 | V | |
| SUPPLY CURRENTS | | | | | |
| Negative (I _{EE}) | | 0.7 | | mA | |
| Positive (I _{DD}) | | | 1 | mA | |

ABSOLUTE MAXIMUM RATINGS

Table 4.

| Parameter | Rating |
|---|-----------------------|
| Tuning | |
| VTUNE | -0.5 V to +15.5 V |
| ITUNE | ±1 µA |
| Supply Voltages | |
| VEE | -0.5 V |
| VDD | 5.6 V |
| VCTL | -0.5 V to VDD + 0.5 V |
| RF Input Power | |
| 2 GHz to 50 GHz | 27 dBm |
| 0.5 GHz to 2 GHz | 19 dBm |
| 0.1 GHz to 0.5 GHz | 6 dBm |
| Hot Switch Input Power | |
| 2 GHz to 50 GHz | 24 dBm |
| 0.5 GHz to 2 GHz | 16 dBm |
| 0.1 GHz to 0.5 GHz | 3 dBm |
| Temperature | |
| Operating | -40°C to +85°C |
| Storage Temperature | -65°C to +150°C |
| Junction for 1 Million Mean Times Between Failures (MTTF) | 150°C |
| Nominal Junction ($T_{\text{PADDLE}} = 85^{\circ}\text{C}$, Input Power ($P_{\text{IN}} = 23 \text{ dBm}$) | 150°C |
| Electrostatic Discharge (ESD) Rating | |
| Human Body Model (HBM) | 250 V |
| Field Induced Charged Device Model (FICDM) | 1250 V |
| Moisture Sensitivity Level (MSL) Rating | MSL3 |

Stresses at or above those listed under Absolute Maximum Ratings may cause permanent damage to the product. This is a stress rating only; functional operation of the product at these or any other conditions above those indicated in the operational section of this specification is not implied. Operation beyond the maximum operating conditions for extended periods may affect product reliability.

ESD CAUTION



ESD (electrostatic discharge) sensitive device. Charged devices and circuit boards can discharge without detection. Although this product features patented or proprietary protection circuitry, damage may occur on devices subjected to high energy ESD. Therefore, proper ESD precautions should be taken to avoid performance degradation or loss of functionality.

PIN CONFIGURATION AND FUNCTION DESCRIPTIONS

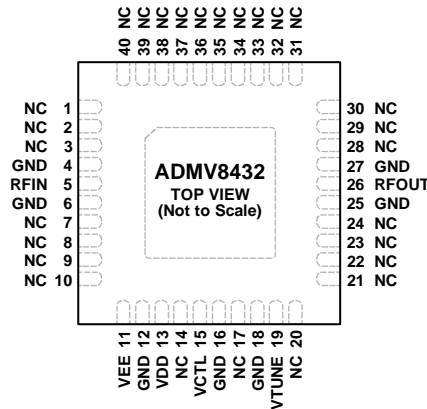

- NOTES**
1. NC = NO CONNECT. THESE PINS ARE NOT CONNECTED INTERNALLY. ALL DATA SHOWN WITHIN WAS MEASURED WITH THESE PINS CONNECTED TO RF AND DC GROUND EXTERNALLY.
 2. THE EXPOSED PAD IS INTERNALLY CONNECTED TO GROUND. SOLDER THE EXPOSED PAD TO A LOW IMPEDANCE GROUND PLANE.

208804-002

Figure 2. Pin Configuration

Table 5. Pin Function Descriptions

| Pin No. | Mnemonic | Description |
|---|----------|---|
| 1 to 3, 7 to 10, 14, 17, 20 to 24, 28 to 40 | NC | No Connect. These pins are not connected internally. All data shown within was measured with these pins connected to RF and dc ground externally. |
| 4, 6, 12, 16, 18, 25, 27 | GND | Ground. These pins must be connected to RF and dc ground. |
| 5 | RFIN | RF Input. This pin is dc-coupled and matched to 50 Ω. Blocking capacitors are required if the RF line potential is not equal to 0 V. |
| 11 | VEE | Negative Supply Voltage. VEE is -5 V. |
| 13 | VDD | Positive Supply Voltage. VDD is 5 V. |
| 15 | VCTL | Control Voltage for Band Selection. The device is in the high band when the voltage is 0 V and in the low band when the voltage is 2.5 V. |
| 19 | VTUNE | Center Frequency Control Voltage of the Band-Pass Filter. VTUNE can be varied from 0 V to 15 V. |
| 26 | RFOUT | RF Output. This pin is dc-coupled and matched to 50 Ω. Blocking capacitors are required if the RF line potential is not equal to 0 V. |
| | EPAD | Exposed Pad. The exposed pad is internally connected to ground. Solder the exposed pad to a low impedance ground plane. |

INTERFACE SCHEMATICS

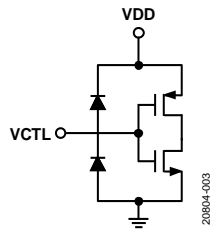

Figure 3. VCTL and VDD Interface Schematic

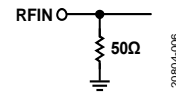

Figure 6. RFIN Interface Schematic

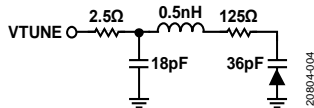

Figure 4. VTUNE Interface Schematic

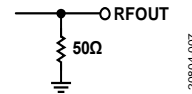

Figure 7. RFOUT Interface Schematic

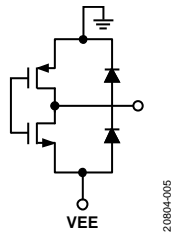

Figure 5. VEE Interface Schematic



Figure 8. GND Interface Schematic

TYPICAL PERFORMANCE CHARACTERISTICS

HIGH BAND

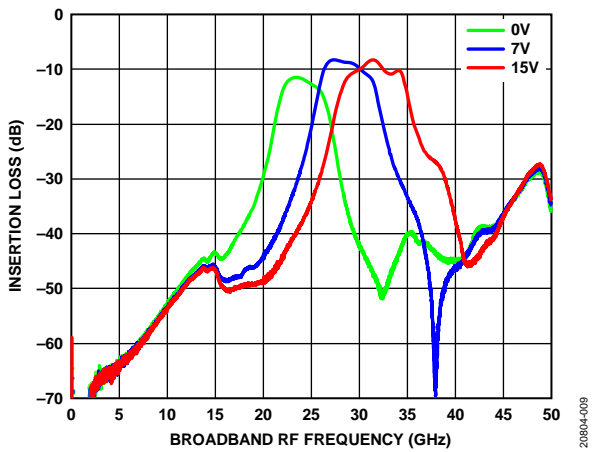

Figure 9. Insertion Loss vs. Broadband RF Frequency at Various VTUNE Voltages

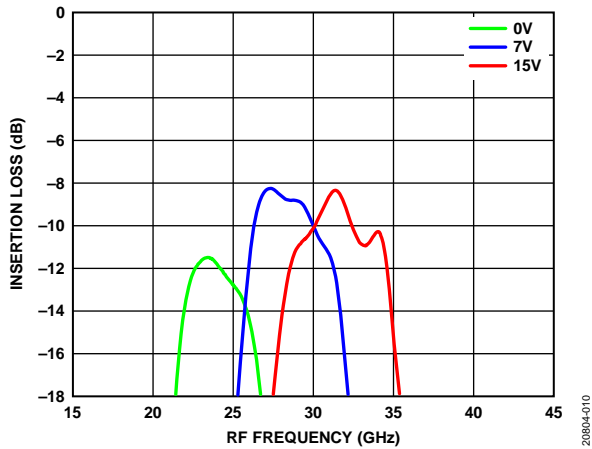

Figure 10. Insertion Loss vs. RF Frequency at Various Voltages

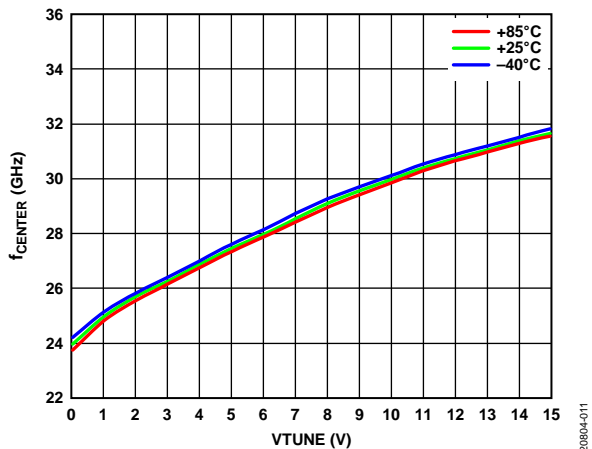

Figure 11. f_{CENTER} vs. VTUNE at Various Temperatures

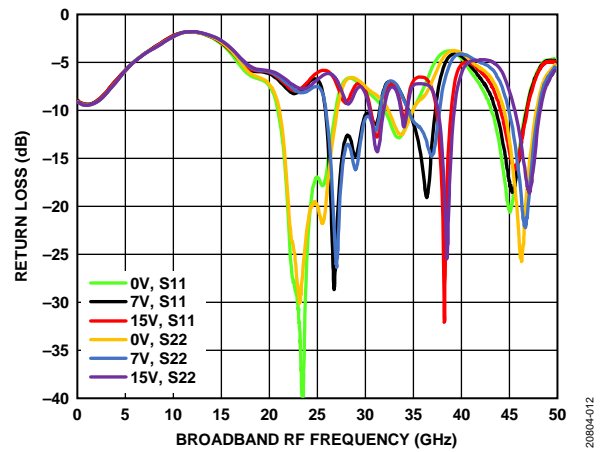

Figure 12. Return Loss vs. Broadband RF Frequency at Various Voltages

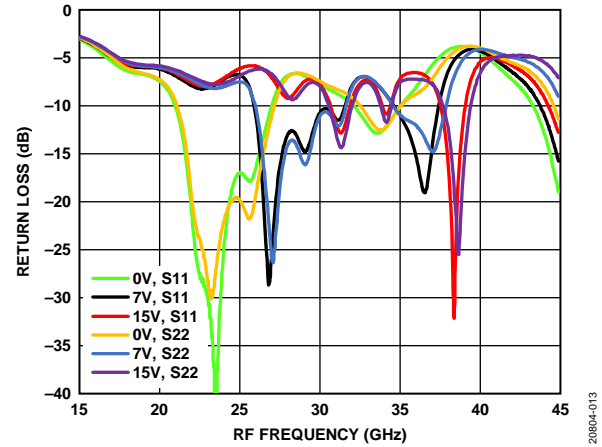

Figure 13. Return Loss vs. RF Frequency at Various Voltages

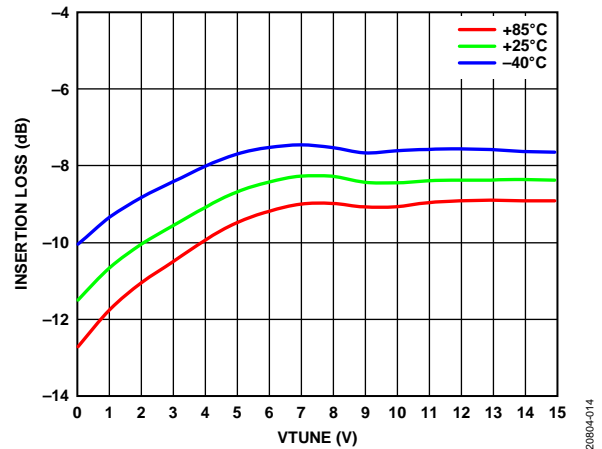

Figure 14. Insertion Loss vs. VTUNE at Various Temperatures

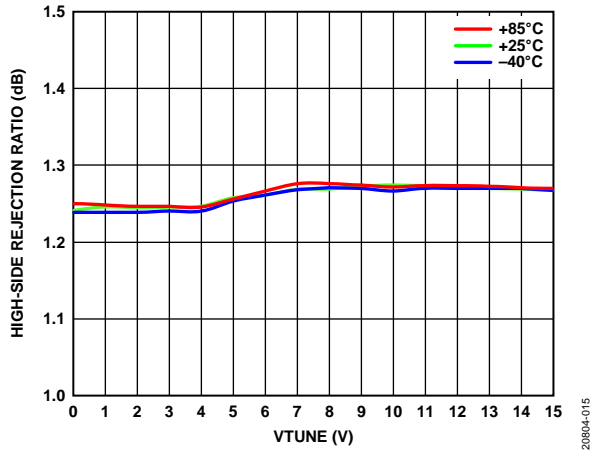

Figure 15. High-Side Rejection vs. VTUNE at Various Temperatures

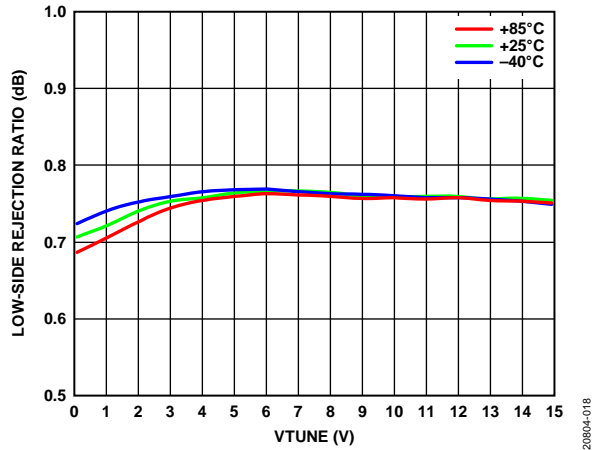

Figure 18. Low-Side Rejection vs. VTUNE at Various Temperatures

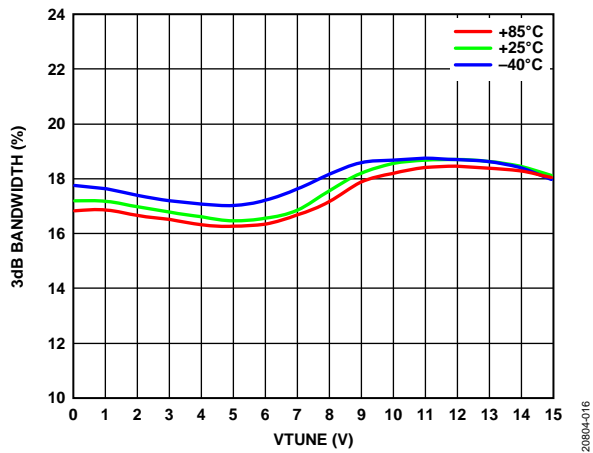

Figure 16. 3 dB Bandwidth vs. VTUNE at Various Temperatures

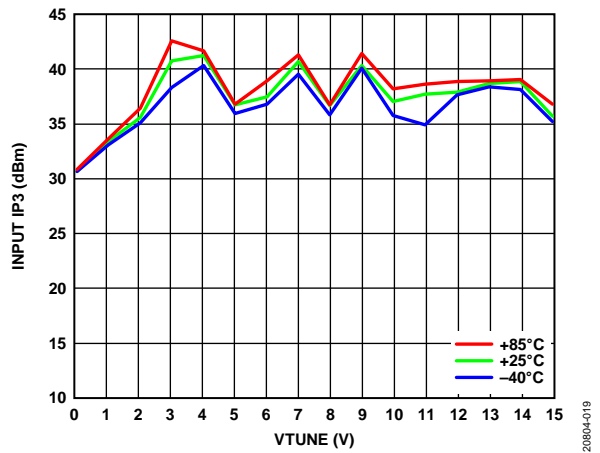

Figure 19. Input IP3 vs. VTUNE at Various Temperatures

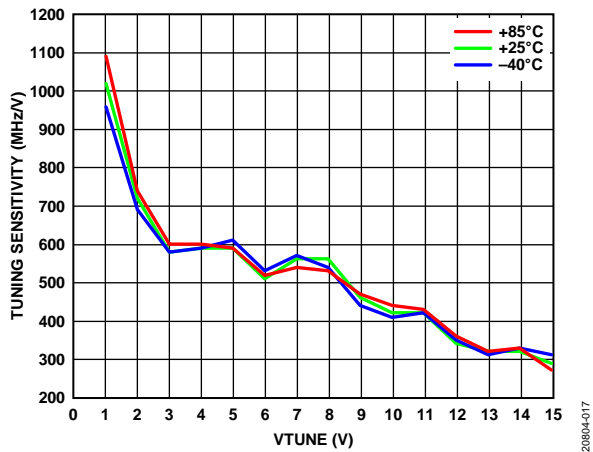

Figure 17. Tuning Sensitivity vs. VTUNE at Various Temperatures

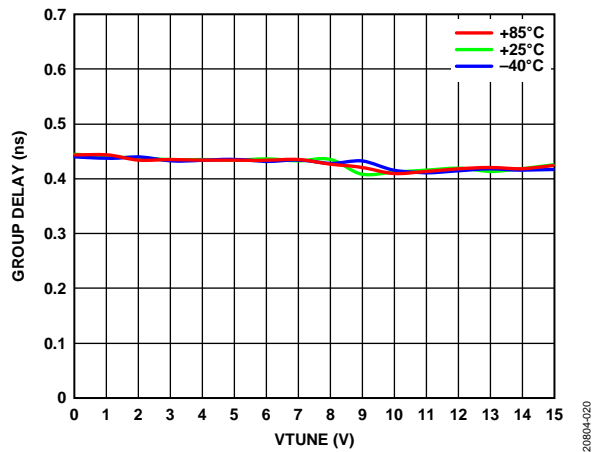

Figure 20. Group Delay vs. VTUNE at Various Temperatures

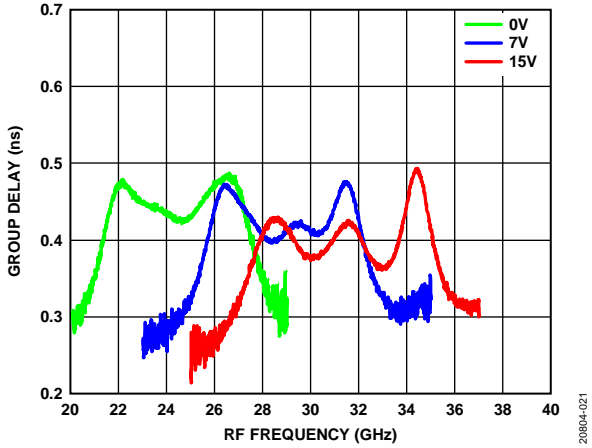

Figure 21. Group Delay vs. RF Frequency at Various VTUNE Voltages

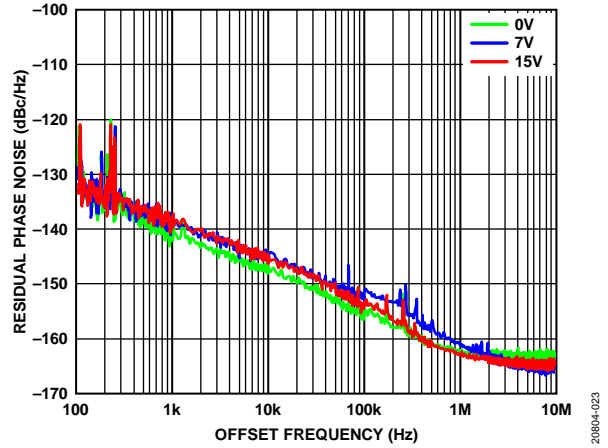

Figure 23. Residual Phase Noise vs. Offset Frequency at Various VTUNE Voltages

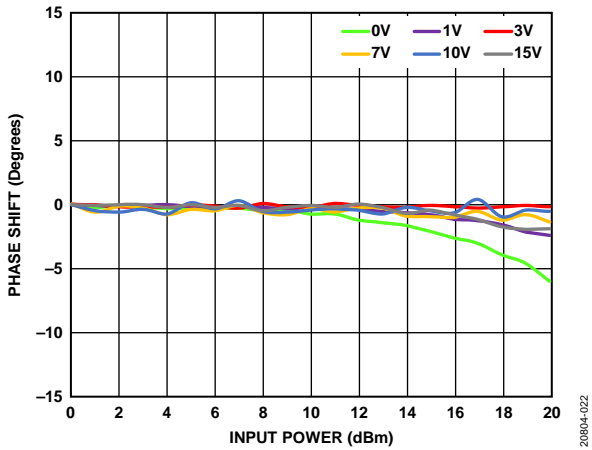

Figure 22. Phase Shift vs. Input Power at Various VTUNE Voltages

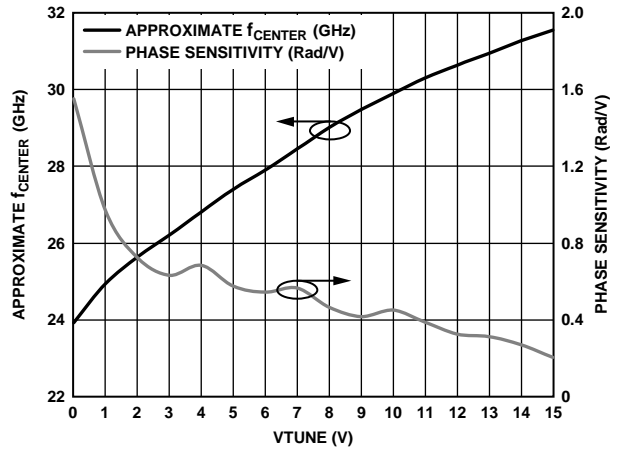

Figure 24. Approximate f_{CENTER} and Phase Sensitivity vs. VTUNE

LOW BAND

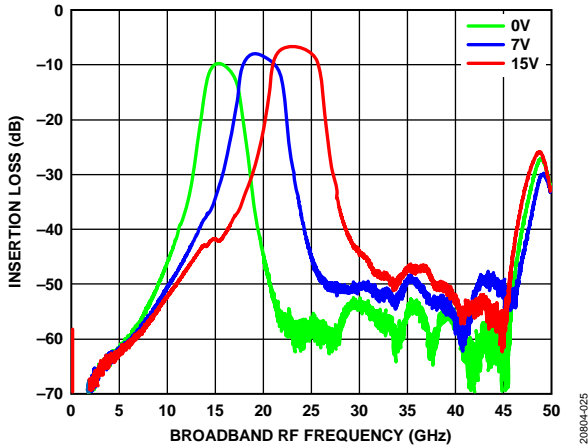

Figure 25. Insertion Loss vs. Broadband RF Frequency for Various VTUNE Voltages

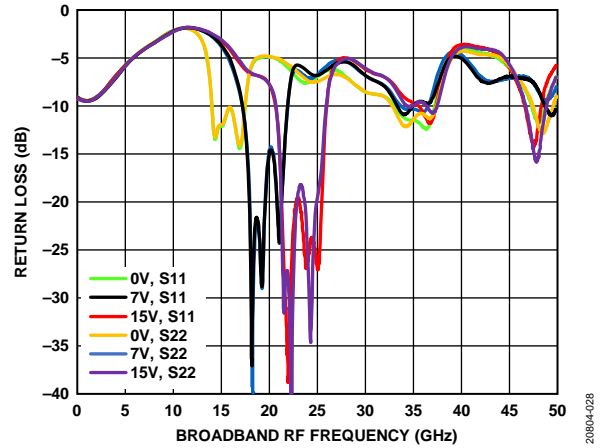

Figure 28. Return Loss vs. Broadband RF Frequency for Various VTUNE Voltages

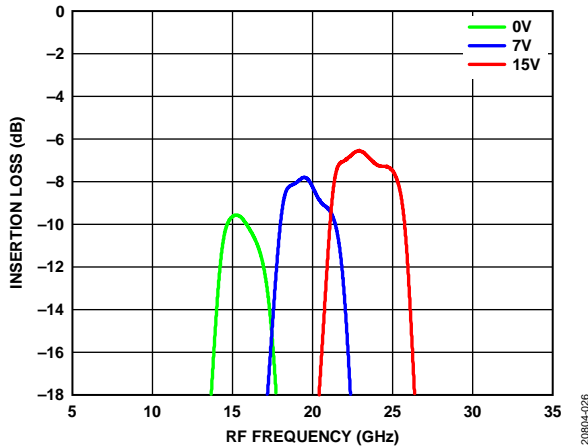

Figure 26. Insertion Loss vs. RF Frequency for Various VTUNE Voltages

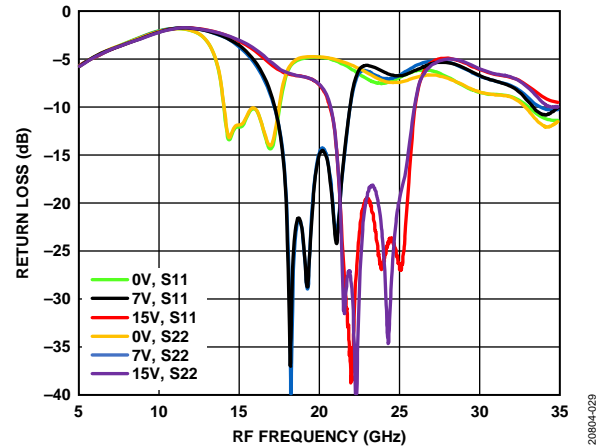

Figure 29. Return Loss vs. RF Frequency for Various VTUNE Voltages

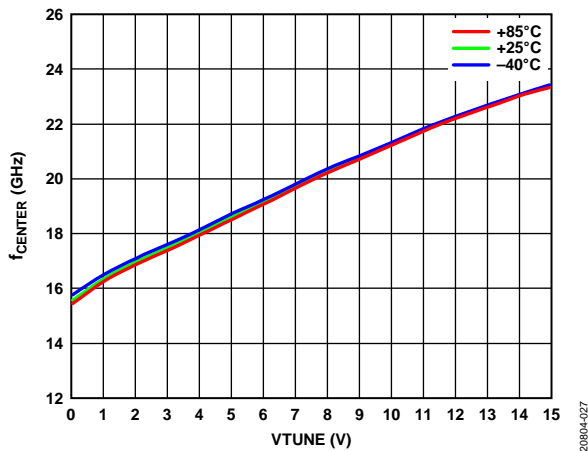

Figure 27. f_{CENTER} vs. VTUNE at Various Temperatures

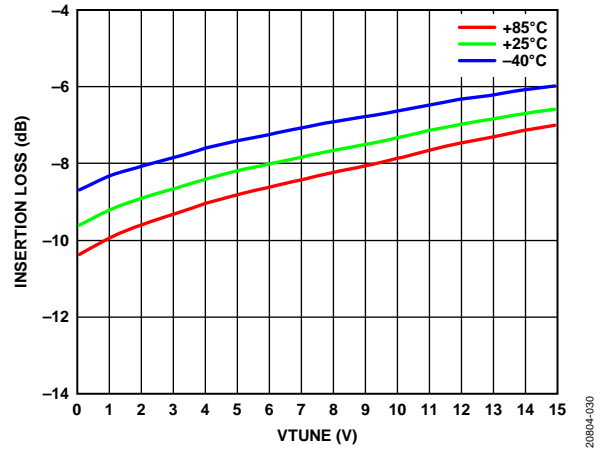

Figure 30. Insertion Loss vs. VTUNE at Various Temperatures

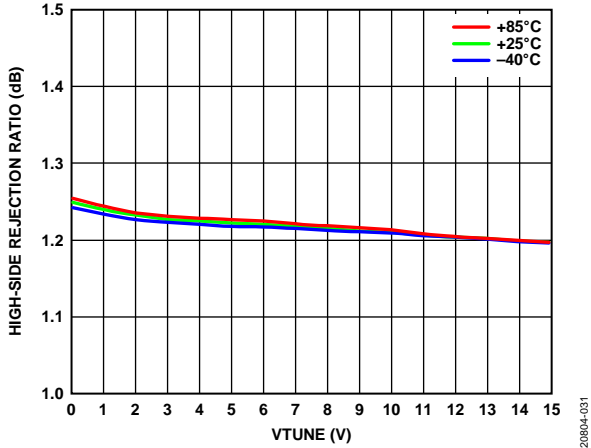

Figure 31. High-Side Rejection vs. VTUNE at Various Temperatures

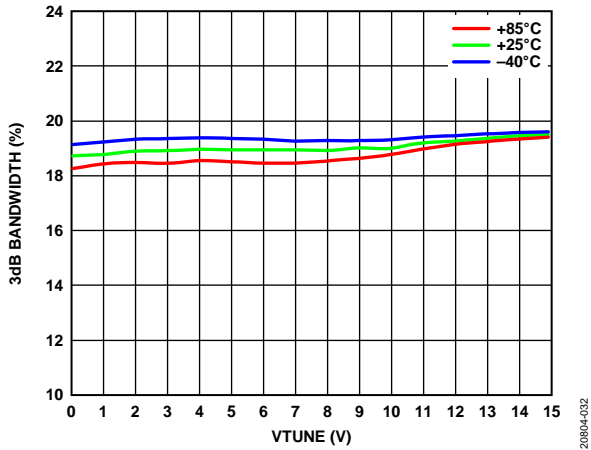

Figure 32. 3 dB Bandwidth vs. VTUNE at Various Temperatures

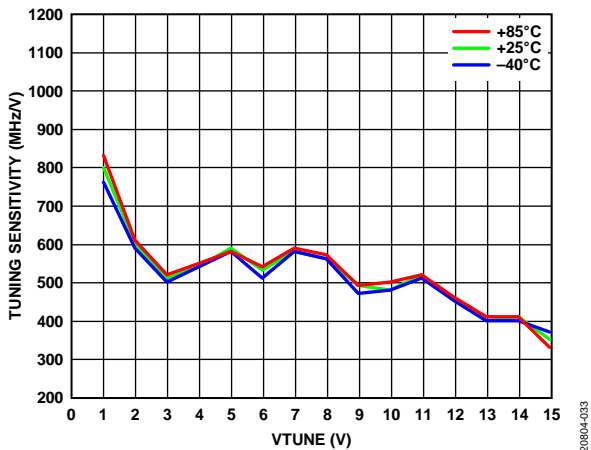

Figure 33. Tuning Sensitivity vs. VTUNE at Various Temperatures

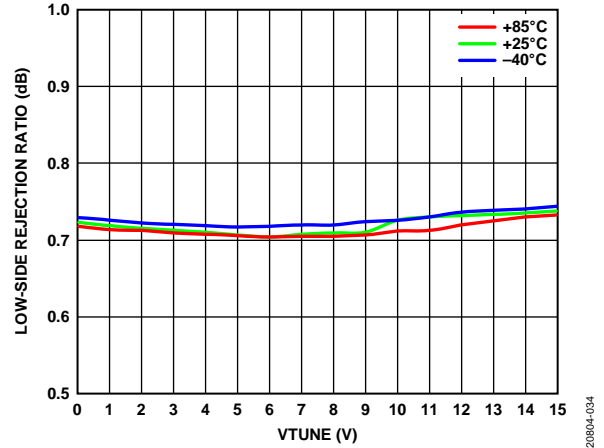

Figure 34. Low-Side Rejection vs. VTUNE at Various Temperatures

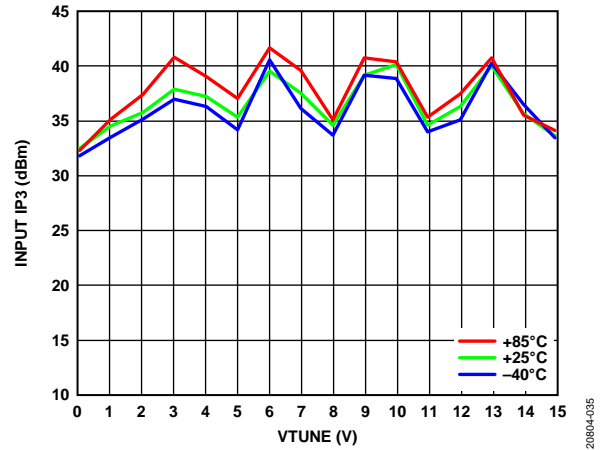

Figure 35. Input IP3 vs. VTUNE at Various Temperatures

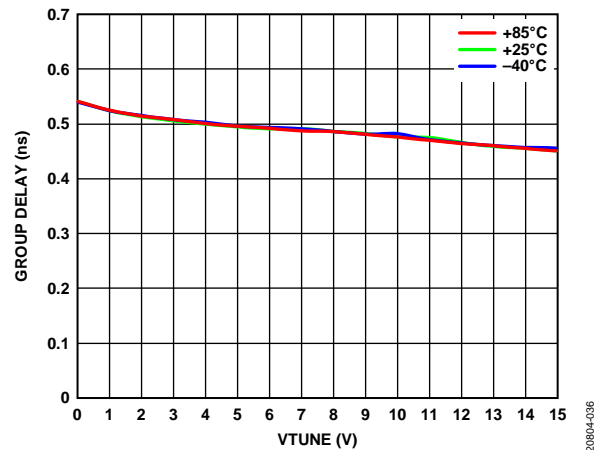

Figure 36. Group Delay vs. VTUNE at Various Temperatures

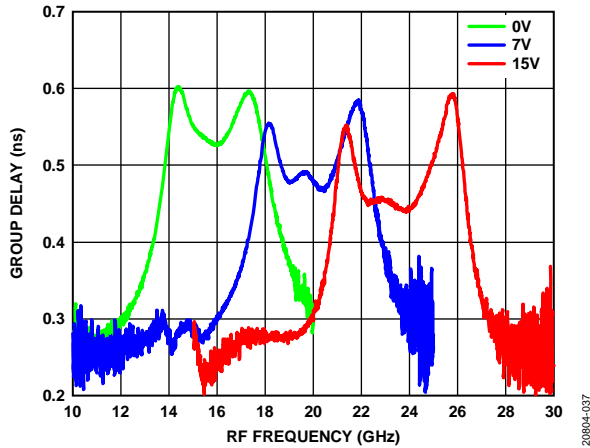

Figure 37. Group Delay vs. RF Frequency at Various VTUNE Voltages

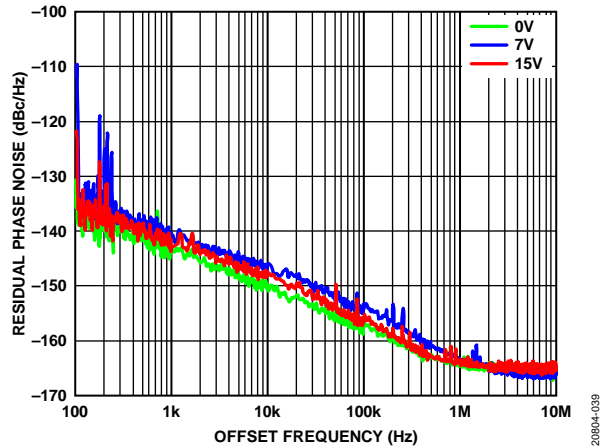

Figure 39. Residual Phase Noise vs. Offset Frequency at Various VTUNE Voltages

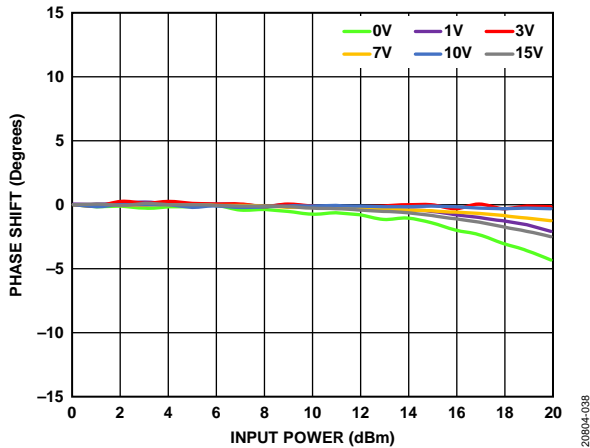

Figure 38. Phase Shift vs. Input Power at Various VTUNE Voltages

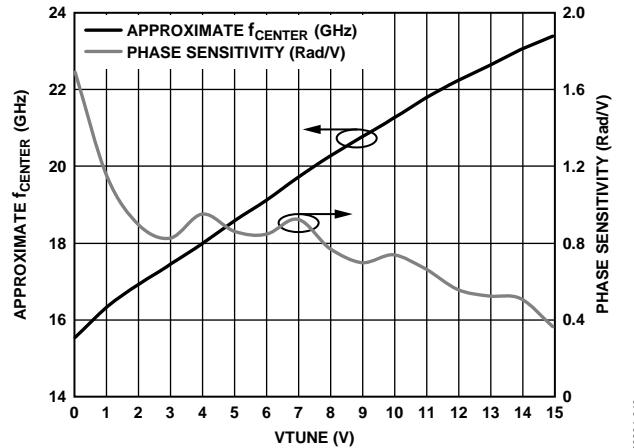

Figure 40. Approximate f_{CENTER} and Phase Sensitivity vs. VTUNE

HIGH BAND AND LOW BAND

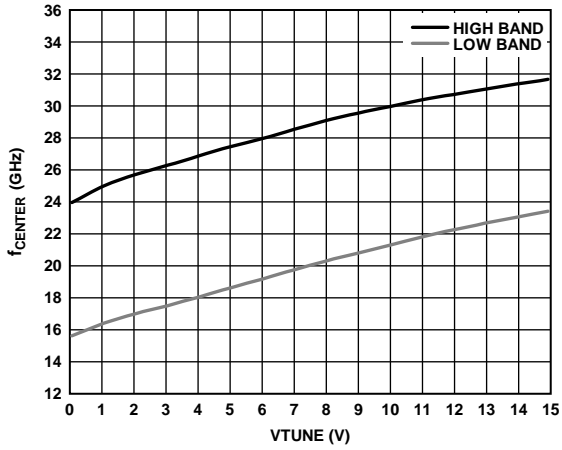

Figure 41. f_{CENTER} vs. VTUNE

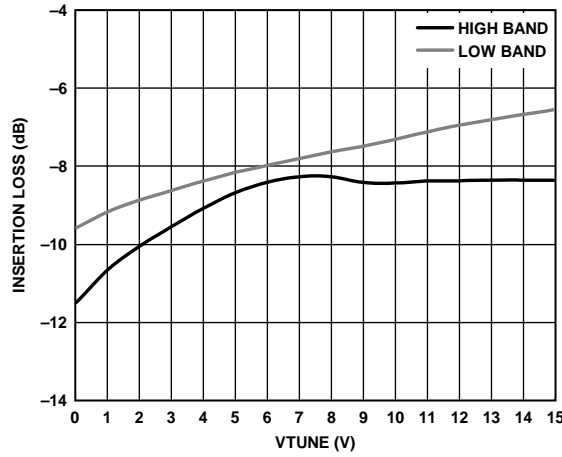

Figure 43. Insertion Loss vs. VTUNE

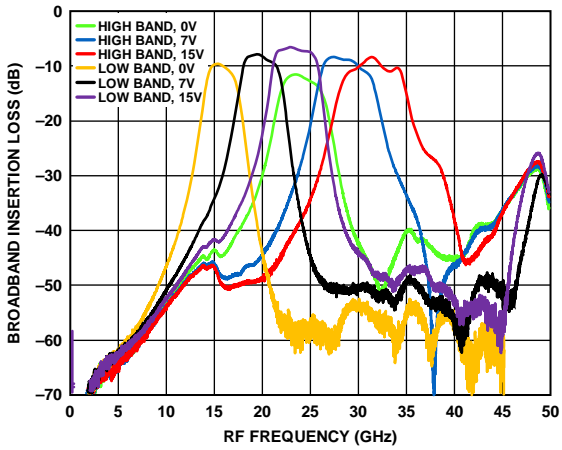

Figure 42. Broadband Insertion Loss vs. RF Frequency

20804-041

20804-043

20804-042

THEORY OF OPERATION

The ADMV8432 is a MMIC, band-pass filter that features a user selectable pass-band frequency. To select the high band, apply 0 V at VCTL, and to select the low band, apply 2.5 V at VCTL. Varying the applied analog tuning voltage between 0 V

and 15 V at VTUNE varies the f_{CENTER} from 16.6 GHz to 22.5 GHz for the low band and from 25.7 GHz to 30.1 GHz for the high band.

APPLICATIONS INFORMATION

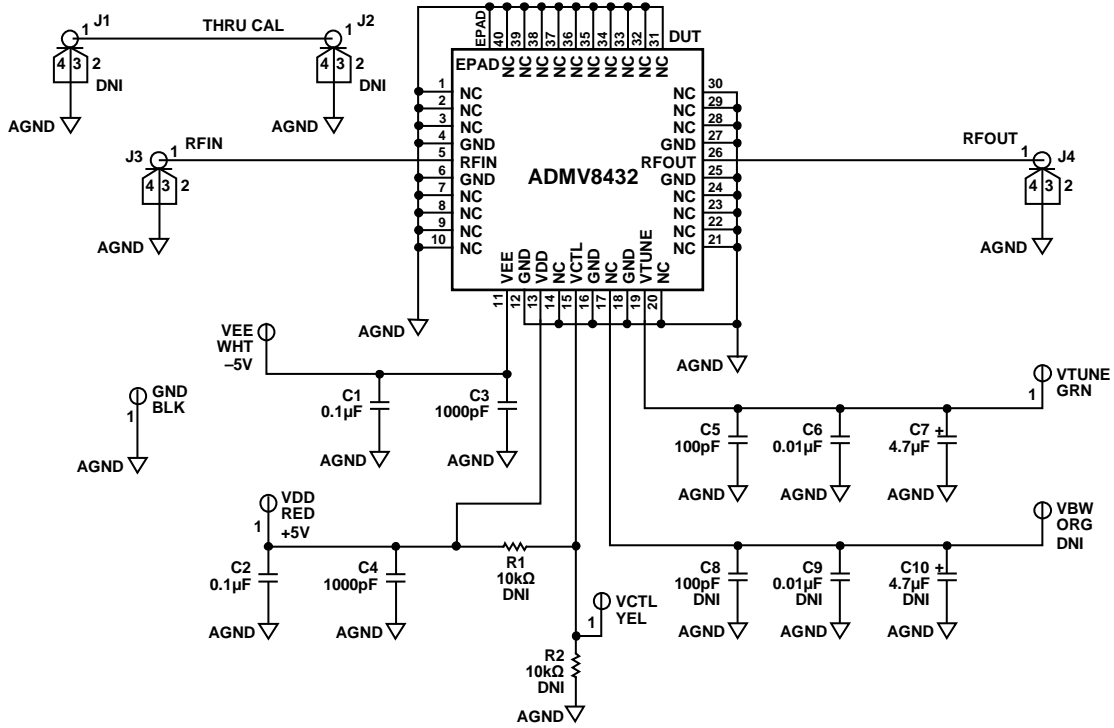

Figure 44. Typical Application Circuit

20804-044

TYPICAL APPLICATION CIRCUIT

Figure 44 shows the typical application circuit for the ADMV8432.

POWER SUPPLY SEQUENCE

The required power-up sequence is GND, VDD, VEE, VCTL, and VTUNE. Deviations from this sequence may forward bias the ESD protection structures and damage them.

OUTLINE DIMENSIONS

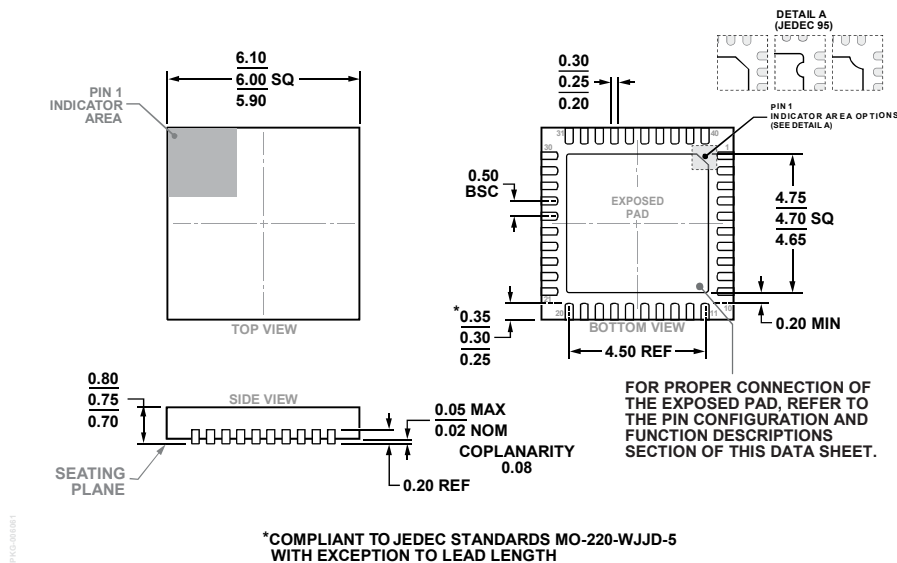

Figure 45. 40-Lead Lead Frame Chip Scale Package [LFCSP]
6 mm × 6 mm Body and 0.75 mm Package Height
(CP-40-27)
Dimensions shown in millimeters

ORDERING GUIDE

| Model ¹ | Temperature Range | Package Description | Package Option |
|--------------------|-------------------|---|----------------|
| ADMV8432ACPZ | -40°C to +85°C | 40-Lead Lead Frame Chip Scale Package [LFCSP] | CP-40-27 |
| ADMV8432ACPZ-R5 | -40°C to +85°C | 40-Lead Lead Frame Chip Scale Package [LFCSP] | CP-40-27 |
| ADMV8432-EVALZ | | Evaluation Board | |

¹ Z = RoHS Compliant Part.