

XLamp® XP-E LEDs

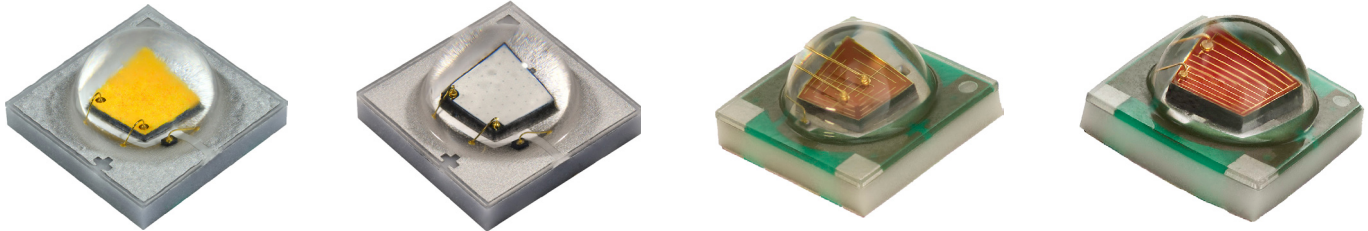

PRODUCT DESCRIPTION

The XLamp® XP-E LED combines the proven lighting-class performance and reliability of the XLamp XR-E LED in a package with 80% smaller footprint. The XLamp XP-E LED continues Cree LED's history of innovation in LEDs for lighting applications with wide viewing angle, symmetrical package, unlimited floor life and electrically neutral thermal path.

XLamp LEDs bring high performance and quality of light to a wide range of lighting applications, including color-changing, portable and personal, outdoor, indoor-directional, transportation, stage and studio, commercial, horticulture and emergency-vehicle lighting.

FEATURES

- Available in white, blue, green, amber, red-orange, red, & High Efficiency (HE) photo red
- Maximum drive current: 1 A
- Low thermal resistance: as low as 5.7 °C/W
- Maximum junction temperature: 150 °C
- Wide viewing angle: 115°-130°
- Unlimited floor life at ≤ 30 °C/85% RH
- Reflow solderable - JEDEC J-STD-020C compatible
- Electrically neutral thermal path
- RoHS and REACH compliant
- UL® recognized component (E349212)



Cree LED / 4400 Silicon Drive / Durham, NC 27703 USA / +1.919.313.5330 / www.cree-led.com

TABLE OF CONTENTS

| | |
|---|----|
| Characteristics | 3 |
| Order Codes Suggested for New Designs - White | 4 |
| Order Codes Suggested for New Designs - Color | 9 |
| Relative Spectral Power Distribution | 13 |
| Relative Flux vs. Junction Temperature..... | 14 |
| Electrical Characteristics..... | 15 |
| Relative Flux vs. Current | 16 |
| Relative Chromaticity vs. Current and Temperature | 18 |
| Typical Spatial Distribution..... | 19 |
| Thermal Design | 20 |
| Performance Groups - Luminous Flux | 21 |
| Performance Groups - Radiant Flux..... | 21 |
| Performance Groups - Chromaticity | 22 |
| Performance Groups - Dominant Wavelength | 26 |
| Performance Groups - Peak Wavelength..... | 26 |
| Performance Groups - Forward Voltage..... | 27 |
| Standard Cool White Kits Plotted on ANSI Standard Chromaticity Regions..... | 28 |
| Standard Warm and Neutral White Kits Plotted on ANSI Standard Chromaticity Regions..... | 29 |
| Standard Chromaticity Kits | 31 |
| Bin and Order Code Formats..... | 32 |
| Reflow Soldering Characteristics..... | 33 |
| Notes | 34 |
| Mechanical Dimensions | 36 |
| Tape and Reel..... | 38 |
| Packaging..... | 40 |
| Appendix - Order Codes Not For New Designs | 41 |

CHARACTERISTICS

| Characteristics | Unit | Minimum | Typical | Maximum |
|--|---------|---------|---------|---------|
| Thermal resistance, junction to solder point - white | °C/W | | 5.8 | |
| Thermal resistance, junction to solder point - blue | °C/W | | 5.7 | |
| Thermal resistance, junction to solder point - green | °C/W | | 9 | |
| Thermal resistance, junction to solder point - amber | °C/W | | 7.5 | |
| Thermal resistance, junction to solder point - red-orange, red, HE photo red | °C/W | | 6.5 | |
| Viewing angle (FWHM) - white | degrees | | 115 | |
| Viewing angle (FWHM) - blue, green, amber, red-orange, red, HE photo red | degrees | | 130 | |
| Temperature coefficient of voltage - white | mV/°C | | -1.5 | |
| Temperature coefficient of voltage - blue | mV/°C | | -1.9 | |
| Temperature coefficient of voltage - green | mV/°C | | -1.2 | |
| Temperature coefficient of voltage - amber | mV/°C | | -2.1 | |
| Temperature coefficient of voltage - red-orange, red | mV/°C | | -1.8 | |
| Temperature coefficient of voltage - HE photo red | mV/°C | | -1.6 | |
| ESD classification (HBM per Mil-Std-883D) | | | Class 2 | |
| DC forward current | mA | | | 1000 |
| Reverse voltage | V | | | 1 |
| Forward voltage (@ 350 mA) - white | V | | 2.93 | 3.4 |
| Forward voltage (@ 350 mA) - blue | V | | 2.95 | 3.4 |
| Forward voltage (@ 350 mA) - green | V | | 2.85 | 3.25 |
| Forward voltage (@ 350 mA) - amber, red-orange, red, HE photo red | V | | 2.1 | 2.5 |
| Forward voltage (@ 500 mA) - amber | V | | 2.3 | |
| Forward voltage (@ 700 mA) - white | V | | 3.1 | |
| Forward voltage (@ 700 mA) - red-orange, red, HE photo red | V | | 2.3 | |
| Forward voltage (@ 1000 mA) - white | V | | 3.23 | |
| Forward voltage (@ 1000 mA) - blue | V | | 3.27 | |
| Forward voltage (@ 1000 mA) - green | V | | 3.16 | |
| Forward voltage (@ 1000 mA) - HE photo red | V | | 2.5 | |
| LED junction temperature | °C | | | 150 |

Note

- Thermal resistance measurement was performed per the JEDEC JESD51-14 standard.

ORDER CODES SUGGESTED FOR NEW DESIGNS - WHITE ($T_j = 25\text{ }^\circ\text{C}$)

The following table provides order codes for XLamp XP-E white LEDs. For a complete description of the order code nomenclature, please see the Bin and Order Code Formats section (page 32).

| Minimum Luminous Flux (lm) @ 350 mA | | Chromaticity Regions | Order Codes |
|-------------------------------------|-----------|--|----------------------|
| Group | Flux (lm) | | |
| S2 | 148 | WA, WB, WC, WD, WE, WF, WG, WH, WJ, WK, WM, WN, WP | XPEWHT-L1-0000-00J01 |
| | | WC, WD, WF, WG | XPEWHT-L1-0000-00J02 |
| | | WC, WD, WF, WG, WH, WJ, WN, WP | XPEWHT-L1-0000-00J03 |
| S3 | 156 | WA, WB, WC, WD, WE, WF, WG, WH, WJ, WK, WM, WN, WP | XPEWHT-L1-0000-00K01 |
| | | WC, WD, WF, WG | XPEWHT-L1-0000-00K02 |
| | | WC, WD, WF, WG, WH, WJ, WN, WP | XPEWHT-L1-0000-00K03 |
| S4 | 164 | WA, WB, WC, WD, WE, WF, WG, WH, WJ, WK, WM, WN, WP | XPEWHT-L1-0000-00L01 |
| | | WC, WD, WF, WG | XPEWHT-L1-0000-00L02 |
| | | WC, WD, WF, WG, WH, WJ, WN, WP | XPEWHT-L1-0000-00L03 |

Notes:

- Cree LED maintains a tolerance of $\pm 7\%$ on flux and power measurements, ± 0.005 on chromaticity (CCx, CCy) measurements and a tolerance of ± 2 on CRI measurements. See the Measurements section (page 34).
- XLamp XP-E LED order codes specify only a minimum flux bin and not a maximum. Cree LED may ship reels in flux bins higher than the minimum specified by the order code without advance notice. Shipments will always adhere to the chromaticity bin restrictions specified by the order code.

ORDER CODES SUGGESTED FOR NEW DESIGNS - WHITE ($T_j = 25\text{ }^\circ\text{C}$) - CONTINUED

The following tables provide order codes for XLamp XP-E white LEDs. For a complete description of the order code nomenclature, please see the Bin and Order Code Formats section (page 32). For definitions of the chromaticity kits, please see the Standard Chromaticity Kits section (page 31).

| Chromaticity | | Minimum Luminous Flux (lm) @ 350 mA | | Order Codes |
|--------------|--------|-------------------------------------|-----------|----------------------|
| Kit | CCT | Code | Flux (lm) | 70 CRI Typical |
| 51 | 6200 K | S4 | 164 | XPEWHT-L1-0000-00L51 |
| | | S3 | 156 | XPEWHT-L1-0000-00K51 |
| | | S2 | 148 | XPEWHT-L1-0000-00J51 |
| 53 | 6000 K | S4 | 164 | XPEWHT-L1-0000-00L53 |
| | | S3 | 156 | XPEWHT-L1-0000-00K53 |
| | | S2 | 148 | XPEWHT-L1-0000-00J53 |
| 50 | 6200 K | S4 | 164 | XPEWHT-L1-0000-00L50 |
| | | S3 | 156 | XPEWHT-L1-0000-00K50 |
| | | S2 | 148 | XPEWHT-L1-0000-00J50 |
| E1 | 6500 K | S4 | 164 | XPEWHT-L1-0000-00LE1 |
| | | S3 | 156 | XPEWHT-L1-0000-00KE1 |
| | | S2 | 148 | XPEWHT-L1-0000-00JE1 |
| E2 | 5700 K | S4 | 164 | XPEWHT-L1-0000-00LE2 |
| | | S3 | 156 | XPEWHT-L1-0000-00KE2 |
| | | S2 | 148 | XPEWHT-L1-0000-00JE2 |

Notes:

- Cree LED maintains a tolerance of $\pm 7\%$ on flux and power measurements, ± 0.005 on chromaticity (CCx, CCy) measurements and a tolerance of ± 2 on CRI measurements. See the Measurements section (page 34).
- XLamp XP-E LED order codes specify only a minimum flux bin and not a maximum. Cree LED may ship reels in flux bins higher than the minimum specified by the order code without advance notice. Shipments will always adhere to the chromaticity bin restrictions specified by the order code.

ORDER CODES SUGGESTED FOR NEW DESIGNS - WHITE ($T_j = 25\text{ }^\circ\text{C}$) - CONTINUED

| Chromaticity | | Minimum Luminous Flux (lm) @ 350 mA | | Order Codes | |
|--------------|--------|-------------------------------------|-----------|----------------------|----------------------|
| Kit | CCT | Code | Flux (lm) | 75 CRI Typical | 80 CRI Minimum |
| E3 | 5000 K | S5 | 172 | XPEWHT-L1-0000-00ME3 | |
| | | S4 | 164 | XPEWHT-L1-0000-00LE3 | |
| | | S3 | 156 | XPEWHT-L1-0000-00KE3 | |
| F4 | 4750 K | S4 | 164 | XPEWHT-L1-0000-00LF4 | |
| | | S3 | 156 | XPEWHT-L1-0000-00KF4 | |
| | | S2 | 148 | XPEWHT-L1-0000-00JF4 | |
| E4 | 4500 K | S4 | 164 | XPEWHT-L1-0000-00LE4 | |
| | | S3 | 156 | XPEWHT-L1-0000-00KE4 | |
| | | S2 | 148 | XPEWHT-L1-0000-00JE4 | |
| F5 | 4250 K | S4 | 164 | XPEWHT-L1-0000-00LF5 | |
| | | S3 | 156 | XPEWHT-L1-0000-00KF5 | |
| | | S2 | 148 | XPEWHT-L1-0000-00JF5 | |
| E5 | 4000 K | S4 | 164 | XPEWHT-L1-0000-00LE5 | |
| | | S3 | 156 | XPEWHT-L1-0000-00KE5 | XPEWHT-H1-0000-00KE5 |
| | | S2 | 148 | XPEWHT-L1-0000-00JE5 | XPEWHT-H1-0000-00JE5 |
| Z5 | 4000 K | S3 | 156 | XPEWHT-L1-0000-00KZ5 | XPEWHT-H1-0000-00KZ5 |
| | | S2 | 148 | XPEWHT-L1-0000-00JZ5 | XPEWHT-H1-0000-00JZ5 |

Notes:

- Cree LED maintains a tolerance of $\pm 7\%$ on flux and power measurements, ± 0.005 on chromaticity (CCx, CCy) measurements and a tolerance of ± 2 on CRI measurements. See the Measurements section (page 34).
- XLamp XP-E LED order codes specify only a minimum flux bin and not a maximum. Cree LED may ship reels in flux bins higher than the minimum specified by the order code without advance notice. Shipments will always adhere to the chromaticity bin restrictions specified by the order code.

ORDER CODES SUGGESTED FOR NEW DESIGNS - WHITE (T_J = 25 °C) - CONTINUED

| Chromaticity | | Minimum Luminous Flux (lm) @ 350 mA | | Order Codes | | |
|--------------|--------|-------------------------------------|-----------|----------------------|----------------------|----------------------|
| Kit | CCT | Code | Flux (lm) | 80 CRI Typical | 80 CRI Minimum | 90 CRI Minimum |
| F6 | 3750 K | S2 | 148 | XPEWHT-L1-0000-00JF6 | XPEWHT-H1-0000-00JF6 | |
| | | R5 | 139 | XPEWHT-L1-0000-00HF6 | XPEWHT-H1-0000-00HF6 | |
| E6 | 3500 K | R5 | 139 | XPEWHT-L1-0000-00HE6 | XPEWHT-H1-0000-00HE6 | |
| | | R4 | 130 | XPEWHT-L1-0000-00GE6 | XPEWHT-H1-0000-00GE6 | |
| Z6 | 3500 K | R5 | 139 | XPEWHT-L1-0000-00HZ6 | XPEWHT-H1-0000-00ZE6 | |
| | | R4 | 130 | XPEWHT-L1-0000-00GZ6 | XPEWHT-H1-0000-00ZE6 | |
| F7 | 3250 K | R5 | 139 | XPEWHT-L1-0000-00HF7 | XPEWHT-H1-0000-00HF7 | |
| | | R4 | 130 | XPEWHT-L1-0000-00GF7 | XPEWHT-H1-0000-00GF7 | |
| E7 | 3000 K | R5 | 139 | XPEWHT-L1-0000-00HE7 | XPEWHT-H1-0000-00HE7 | |
| | | R4 | 130 | XPEWHT-L1-0000-00GE7 | XPEWHT-H1-0000-00GE7 | |
| | | R3 | 122 | | | |
| | | R2 | 114 | | | |
| | | Q5 | 107 | | | XPEWHT-U1-0000-00DE7 |
| | | Q4 | 100 | | | XPEWHT-U1-0000-00CE7 |
| Z7 | 3000 K | R5 | 139 | XPEWHT-L1-0000-00HE7 | XPEWHT-H1-0000-00HE7 | |
| | | R4 | 130 | XPEWHT-L1-0000-00GE7 | XPEWHT-H1-0000-00GE7 | |
| | | R3 | 122 | | | |
| | | R2 | 114 | | | |
| | | Q5 | 107 | | | XPEWHT-U1-0000-00DZ7 |
| | | Q4 | 100 | | | XPEWHT-U1-0000-00CZ7 |
| F8 | 2850 K | R5 | 139 | XPEWHT-L1-0000-00HF8 | XPEWHT-H1-0000-00HF8 | |
| | | R4 | 130 | XPEWHT-L1-0000-00GF8 | XPEWHT-H1-0000-00GF8 | |
| | | R3 | 122 | XPEWHT-L1-0000-00FF8 | XPEWHT-H1-0000-00FF8 | |
| | | R2 | 114 | | | |
| | | Q5 | 107 | | | XPEWHT-U1-0000-00DF8 |
| | | Q4 | 100 | | | XPEWHT-U1-0000-00CF8 |
| | | Q3 | 93.9 | | | XPEWHT-U1-0000-00BF8 |
| E8 | 2700 K | R5 | 139 | XPEWHT-L1-0000-00HE8 | XPEWHT-H1-0000-00HE8 | |
| | | R4 | 130 | XPEWHT-L1-0000-00GE8 | XPEWHT-H1-0000-00GE8 | |
| | | R3 | 122 | XPEWHT-L1-0000-00FE8 | XPEWHT-H1-0000-00FE8 | |
| | | R2 | 114 | | | |
| | | Q5 | 107 | | | XPEWHT-U1-0000-00DF8 |
| | | Q4 | 100 | | | XPEWHT-U1-0000-00CF8 |
| | | Q3 | 93.9 | | | XPEWHT-U1-0000-00BF8 |

Notes:

- Cree LED maintains a tolerance of ±7% on flux and power measurements, ±0.005 on chromaticity (CCx, CCy) measurements and a tolerance of ±2 on CRI measurements. See the Measurements section (page 34).
- XLamp XP-E LED order codes specify only a minimum flux bin and not a maximum. Cree LED may ship reels in flux bins higher than the minimum specified by the order code without advance notice. Shipments will always adhere to the chromaticity bin restrictions specified by the order code.

ORDER CODES SUGGESTED FOR NEW DESIGNS - WHITE ($T_j = 25\text{ }^\circ\text{C}$) - CONTINUED

| Chromaticity | | Minimum Luminous Flux (lm) @ 350 mA | | Order Codes | | |
|--------------|--------|-------------------------------------|-----------|----------------------|----------------------|----------------------|
| Kit | CCT | Code | Flux (lm) | 80 CRI Typical | 80 CRI Minimum | 90 CRI Minimum |
| Z8 | 2700 K | R5 | 139 | XPEWHT-L1-0000-00HZ8 | XPEWHT-H1-0000-00HZ8 | |
| | | R4 | 130 | XPEWHT-L1-0000-00GZ8 | XPEWHT-H1-0000-00GZ8 | |
| | | R3 | 122 | XPEWHT-L1-0000-00FZ8 | XPEWHT-H1-0000-00FZ8 | |
| | | R2 | 114 | | | |
| | | Q5 | 107 | | | |
| | | Q4 | 100 | | | XPEWHT-U1-0000-00CZ8 |
| | | Q3 | 93.9 | | | XPEWHT-U1-0000-00BZ8 |

Notes:

- Cree LED maintains a tolerance of $\pm 7\%$ on flux and power measurements, ± 0.005 on chromaticity (CCx, CCy) measurements and a tolerance of ± 2 on CRI measurements. See the Measurements section (page 34).
- XLamp XP-E LED order codes specify only a minimum flux bin and not a maximum. Cree LED may ship reels in flux bins higher than the minimum specified by the order code without advance notice. Shipments will always adhere to the chromaticity bin restrictions specified by the order code.

ORDER CODES SUGGESTED FOR NEW DESIGNS - COLOR ($T_j = 25\text{ }^\circ\text{C}$)

The following tables provide order codes for XLamp XP-E color LEDs. For a complete description of the order code nomenclature, please see the Bin and Order Code Formats section (page 32).

| Color | Minimum Luminous Flux (lm)@ 350 mA | | Dominant Wavelength (nm) | | | | Order Codes |
|-------|------------------------------------|-----------|--------------------------|----------|---------|----------|----------------------|
| | | | Minimum | | Maximum | | |
| | Group | Flux (lm) | Group | DWL (nm) | Group | DWL (nm) | |
| Blue | K2 | 30.6 | B3 | 465 | B6 | 485 | XPEBLU-L1-0000-00Y01 |
| | | | B3 | 465 | B5 | 480 | XPEBLU-L1-0000-00Y02 |
| | K3 | 35.2 | B3 | 465 | B6 | 485 | XPEBLU-L1-0000-00Z01 |
| | | | B3 | 465 | B5 | 480 | XPEBLU-L1-0000-00Z02 |
| | M2 | 39.8 | B3 | 465 | B6 | 485 | XPEBLU-L1-0000-00201 |
| | | | B3 | 465 | B5 | 480 | XPEBLU-L1-0000-00202 |
| | | | B4 | 470 | B5 | 480 | XPEBLU-L1-0000-00205 |
| | M3 | 45.7 | B3 | 465 | B6 | 485 | XPEBLU-L1-0000-00301 |
| | | | B3 | 465 | B5 | 480 | XPEBLU-L1-0000-00302 |
| | | | B4 | 470 | B5 | 480 | XPEBLU-L1-0000-00305 |
| | N2 | 51.7 | B3 | 465 | B6 | 485 | XPEBLU-L1-0000-00401 |
| | | | B3 | 465 | B5 | 480 | XPEBLU-L1-0000-00402 |
| | | | B4 | 470 | B5 | 480 | XPEBLU-L1-0000-00405 |
| | N3 | 56.8 | B3 | 465 | B6 | 485 | XPEBLU-L1-0000-00501 |
| | | | B3 | 465 | B5 | 480 | XPEBLU-L1-0000-00502 |
| | | | B4 | 470 | B5 | 480 | XPEBLU-L1-0000-00505 |
| | N4 | 62.0 | B3 | 465 | B6 | 485 | XPEBLU-L1-0000-00601 |

Notes:

- Cree LED maintains a tolerance of $\pm 7\%$ on flux and power measurements, and $\pm 1\text{ nm}$ on dominant wavelength measurements. See the Measurements section (page 34).
- XLamp XP-E LED order codes specify only a minimum flux bin and not a maximum. Cree LED may ship reels in flux bins higher than the minimum specified by the order code without advance notice. Shipments will always adhere to the chromaticity bin restrictions specified by the order code.
- Calculated Photosynthetic Photon Flux (PPF) values are for reference only.

ORDER CODES SUGGESTED FOR NEW DESIGNS - COLOR (T_J = 25 °C) - CONTINUED

| Color | Minimum Luminous Flux (lm)@ 350 mA | | Calculated Minimum PPF (μmol/s) | Dominant Wavelength (nm) | | | | Order Codes |
|-------|------------------------------------|-----------|---------------------------------|--------------------------|----------|---------|----------|----------------------|
| | | | | Minimum | | Maximum | | |
| | Group | Flux (lm) | | Group | DWL (nm) | Group | DWL (nm) | |
| Green | P4 | 80.6 | 0.74 | G2 | 520 | G4 | 535 | XPEGRN-L1-0000-00901 |
| | | | | G2 | 520 | G3 | 530 | XPEGRN-L1-0000-00902 |
| | | | | G3 | 525 | G4 | 535 | XPEGRN-L1-0000-00903 |
| | Q2 | 87.4 | 0.80 | G2 | 520 | G4 | 535 | XPEGRN-L1-0000-00A01 |
| | | | | G2 | 520 | G3 | 530 | XPEGRN-L1-0000-00A02 |
| | | | | G3 | 525 | G4 | 535 | XPEGRN-L1-0000-00A03 |
| | Q3 | 93.9 | 0.86 | G2 | 520 | G4 | 535 | XPEGRN-L1-0000-00B01 |
| | | | | G2 | 520 | G3 | 530 | XPEGRN-L1-0000-00B02 |
| | | | | G3 | 525 | G4 | 535 | XPEGRN-L1-0000-00B03 |
| | Q4 | 100 | 0.91 | G2 | 520 | G4 | 535 | XPEGRN-L1-0000-00C01 |
| | | | | G2 | 520 | G3 | 530 | XPEGRN-L1-0000-00C02 |
| | | | | G3 | 525 | G4 | 535 | XPEGRN-L1-0000-00C03 |
| | Q5 | 107 | 0.98 | G2 | 520 | G4 | 535 | XPEGRN-L1-0000-00D01 |
| | | | | G2 | 520 | G3 | 530 | XPEGRN-L1-0000-00D02 |
| | | | | G3 | 525 | G4 | 535 | XPEGRN-L1-0000-00D03 |
| | R2 | 114 | 1.04 | G2 | 520 | G4 | 535 | XPEGRN-L1-0000-00E01 |
| | | | | G2 | 520 | G3 | 530 | XPEGRN-L1-0000-00E02 |
| | | | | G3 | 525 | G4 | 535 | XPEGRN-L1-0000-00E03 |
| | R3 | 122 | 1.11 | G2 | 520 | G4 | 535 | XPEGRN-L1-0000-00F01 |
| | | | | G2 | 520 | G3 | 530 | XPEGRN-L1-0000-00F02 |

| Color | Minimum Luminous Flux (lm)@ 350 mA | | Dominant Wavelength (nm) | | | | Order Codes |
|-------|------------------------------------|-----------|--------------------------|----------|---------|----------|----------------------|
| | | | Minimum | | Maximum | | |
| | Group | Flux (lm) | Group | DWL (nm) | Group | DWL (nm) | |
| Amber | M3 | 45.7 | A2 | 585 | A3 | 595 | XPEAMB-L1-0000-00301 |
| | | | A3 | 590 | A3 | 595 | XPEAMB-L1-0000-00303 |
| | N2 | 51.7 | A2 | 585 | A3 | 595 | XPEAMB-L1-0000-00401 |
| | | | A3 | 590 | A3 | 595 | XPEAMB-L1-0000-00403 |
| | N3 | 56.8 | A2 | 585 | A3 | 595 | XPEAMB-L1-0000-00501 |
| | | | A3 | 590 | A3 | 595 | XPEAMB-L1-0000-00503 |
| | N4 | 62.0 | A2 | 585 | A3 | 595 | XPEAMB-L1-0000-00601 |
| | | | A3 | 590 | A3 | 595 | XPEAMB-L1-0000-00603 |
| | P2 | 67.2 | A2 | 585 | A3 | 595 | XPEAMB-L1-0000-00701 |
| | | | A3 | 590 | A3 | 595 | XPEAMB-L1-0000-00703 |

Notes:

- Cree LED maintains a tolerance of ±7% on flux and power measurements, ±0.005 on chromaticity (CCx, CCy) measurements and a tolerance of ±2 on CRI measurements. See the Measurements section (page 34).
- XLamp XP-E LED order codes specify only a minimum flux bin and not a maximum. Cree LED may ship reels in flux bins higher than the minimum specified by the order code without advance notice. Shipments will always adhere to the chromaticity bin restrictions specified by the order code.

ORDER CODES SUGGESTED FOR NEW DESIGNS - COLOR (T_j = 25 °C) - CONTINUED

| Color | Minimum Luminous Flux (lm)@ 350 mA | | Dominant Wavelength (nm) | | | | Order Codes |
|------------|------------------------------------|-----------|--------------------------|----------|---------|----------|----------------------|
| | | | Minimum | | Maximum | | |
| | Group | Flux (lm) | Group | DWL (nm) | Group | DWL (nm) | |
| Red-Orange | N3 | 56.8 | 03 | 610 | 04 | 620 | XPERDO-L1-0000-00501 |
| | | | 03 | 610 | 03 | 615 | XPERDO-L1-0000-00502 |
| | | | 04 | 615 | 04 | 620 | XPERDO-L1-0000-00503 |
| | N4 | 62.0 | 03 | 610 | 04 | 620 | XPERDO-L1-0000-00601 |
| | | | 03 | 610 | 03 | 615 | XPERDO-L1-0000-00602 |
| | | | 04 | 615 | 04 | 620 | XPERDO-L1-0000-00603 |
| | P2 | 67.2 | 03 | 610 | 04 | 620 | XPERDO-L1-0000-00701 |
| | | | 03 | 610 | 03 | 615 | XPERDO-L1-0000-00702 |
| | | | 04 | 615 | 04 | 620 | XPERDO-L1-0000-00703 |
| | P3 | 73.9 | 03 | 610 | 04 | 620 | XPERDO-L1-0000-00801 |
| | | | 03 | 610 | 03 | 615 | XPERDO-L1-0000-00802 |
| | | | 04 | 615 | 04 | 620 | XPERDO-L1-0000-00803 |
| | P4 | 80.6 | 03 | 610 | 04 | 620 | XPERDO-L1-0000-00901 |
| | | | 03 | 610 | 03 | 615 | XPERDO-L1-0000-00902 |
| | | | 04 | 615 | 04 | 620 | XPERDO-L1-0000-00903 |
| | Q2 | 87.4 | 03 | 610 | 04 | 620 | XPERDO-L1-0000-00A01 |
| | | | 03 | 610 | 03 | 615 | XPERDO-L1-0000-00A02 |
| | | | 04 | 615 | 04 | 620 | XPERDO-L1-0000-00A03 |

| Color | Minimum Luminous Flux (lm)@ 350 mA | | Calculated Minimum PPF (μmol/s) | Dominant Wavelength (nm) | | | | Order Codes |
|-------|------------------------------------|-----------|---------------------------------|--------------------------|----------|---------|----------|----------------------|
| | | | | Minimum | | Maximum | | |
| | Group | Flux (lm) | | Group | DWL (nm) | Group | DWL (nm) | |
| Red | M3 | 45.7 | 1.19 | R2 | 620 | R3 | 630 | XPERED-L1-0000-00301 |
| | | | | R2 | 620 | R2 | 625 | XPERED-L1-0000-00302 |
| | N2 | 51.7 | 1.35 | R2 | 620 | R3 | 630 | XPERED-L1-0000-00401 |
| | | | | R2 | 620 | R2 | 625 | XPERED-L1-0000-00402 |
| | N3 | 56.8 | 1.48 | R2 | 620 | R3 | 630 | XPERED-L1-0000-00501 |
| | | | | R2 | 620 | R2 | 625 | XPERED-L1-0000-00502 |
| | N4 | 62 | 1.61 | R2 | 620 | R3 | 630 | XPERED-L1-0000-00601 |
| | | | | R2 | 620 | R2 | 625 | XPERED-L1-0000-00602 |
| | P2 | 67.2 | 1.75 | R2 | 620 | R3 | 630 | XPERED-L1-0000-00701 |
| | | | | R2 | 620 | R2 | 625 | XPERED-L1-0000-00702 |
| | P3 | 73.9 | 1.92 | R2 | 620 | R3 | 630 | XPERED-L1-0000-00801 |
| | | | | R2 | 620 | R2 | 625 | XPERED-L1-0000-00802 |

Notes:

- Cree LED maintains a tolerance of ±7% on flux and power measurements, and ±1 nm on dominant wavelength measurements. See the Measurements section (page 34).
- XLamp XP-E LED order codes specify only a minimum flux bin and not a maximum. Cree LED may ship reels in flux bins higher than the minimum specified by the order code without advance notice. Shipments will always adhere to the chromaticity bin restrictions specified by the order code.
- Calculated Photosynthetic Photon Flux (PPF) values are for reference only.

ORDER CODES SUGGESTED FOR NEW DESIGNS - COLOR ($T_j = 25\text{ }^\circ\text{C}$) - CONTINUED

| Color | Minimum Radiant Flux (mW)@ 350 mA | | Calculated Minimum PPF ($\mu\text{mol/s}$) | Peak Wavelength (nm) | | | | Order Codes |
|--------------|-----------------------------------|-----------|--|----------------------|----------|---------|----------|----------------------|
| | | | | Minimum | | Maximum | | |
| | Group | Flux (mW) | | Group | PWL (nm) | Group | PWL (nm) | |
| HE Photo Red | 26 | 350 | 1.93 | P2 | 650 | P5 | 670 | XPEEPR-L1-0000-00901 |
| | 27 | 375 | 2.06 | P2 | 650 | P5 | 670 | XPEEPR-L1-0000-00A01 |
| | 28 | 400 | 2.20 | P2 | 650 | P5 | 670 | XPEEPR-L1-0000-00B01 |
| | 29 | 425 | 2.34 | P2 | 650 | P5 | 670 | XPEEPR-L1-0000-00C01 |

Notes:

- Cree LED maintains a tolerance of $\pm 7\%$ on flux and power measurements, and $\pm 1\text{ nm}$ on dominant wavelength measurements. See the Measurements section (page 34).
- XLamp XP-E LED order codes specify only a minimum flux bin and not a maximum. Cree LED may ship reels in flux bins higher than the minimum specified by the order code without advance notice. Shipments will always adhere to the chromaticity bin restrictions specified by the order code.
- Calculated Photosynthetic Photon Flux (PPF) values are for reference only.

RELATIVE SPECTRAL POWER DISTRIBUTION

White

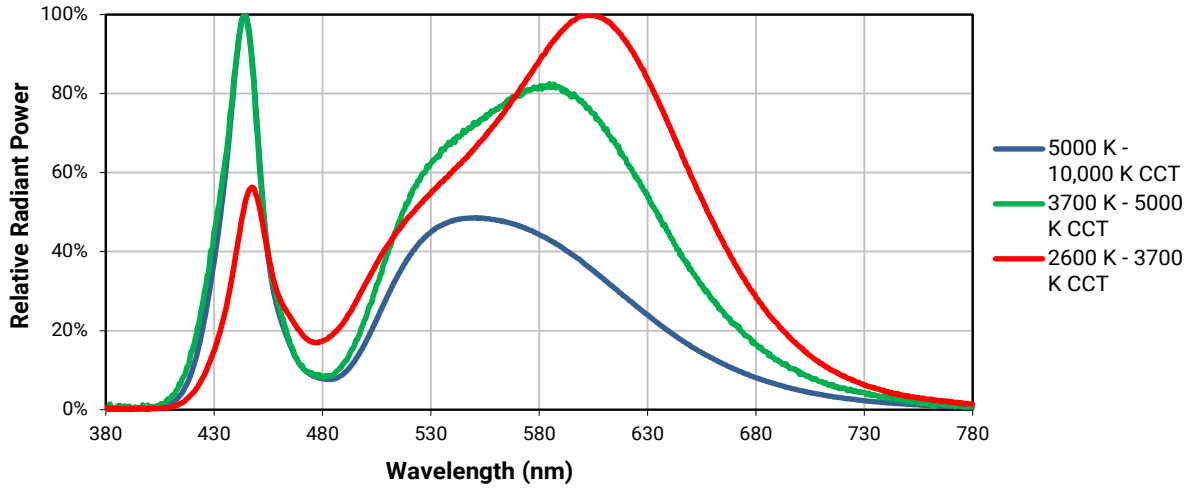

Color

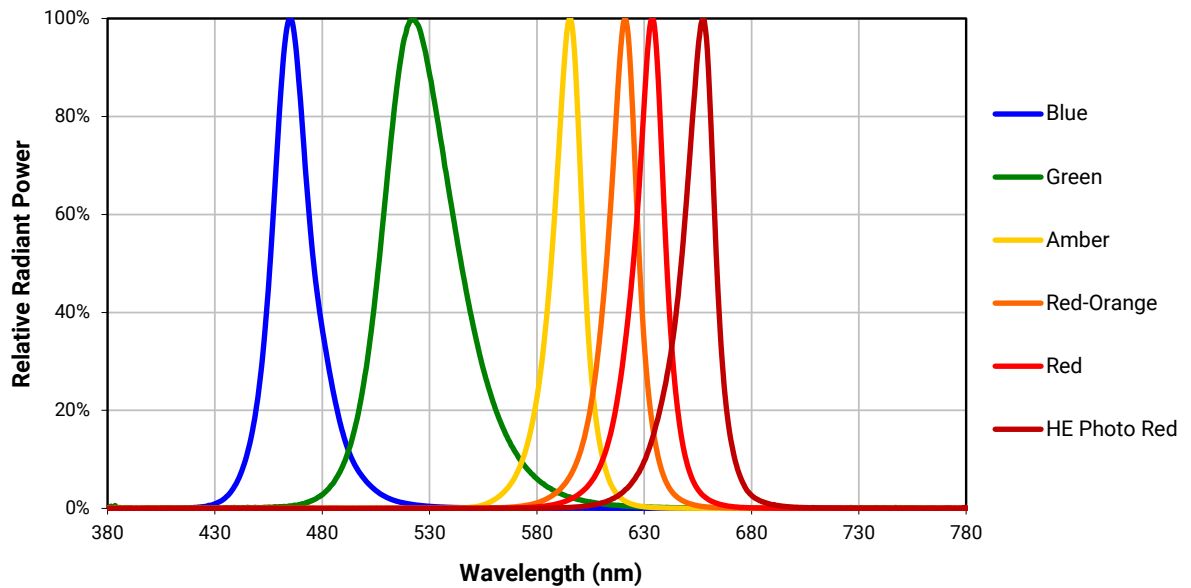

RELATIVE FLUX VS. JUNCTION TEMPERATURE ($I_f = 350 \text{ mA}$)

White

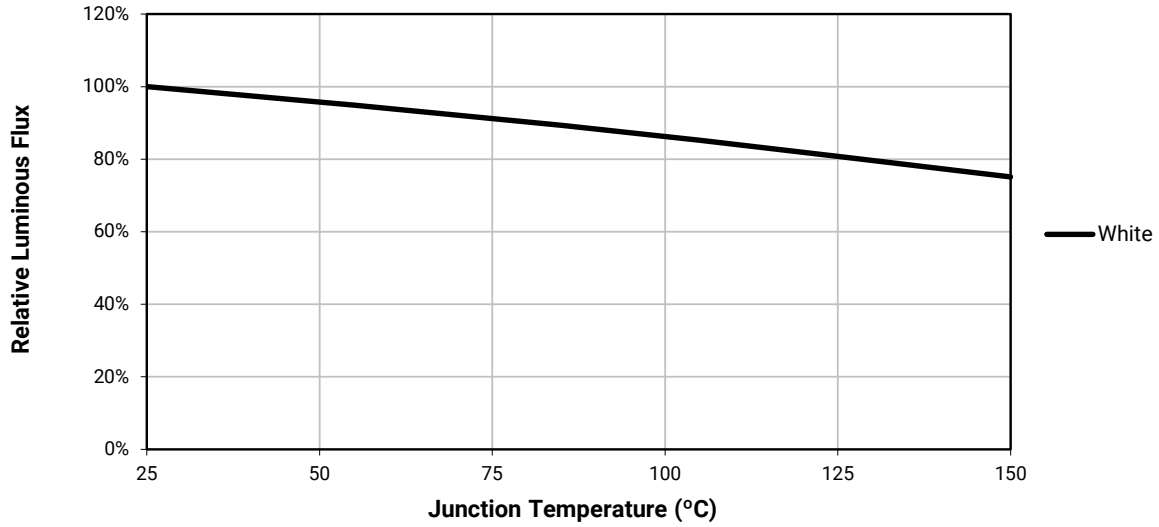

Color

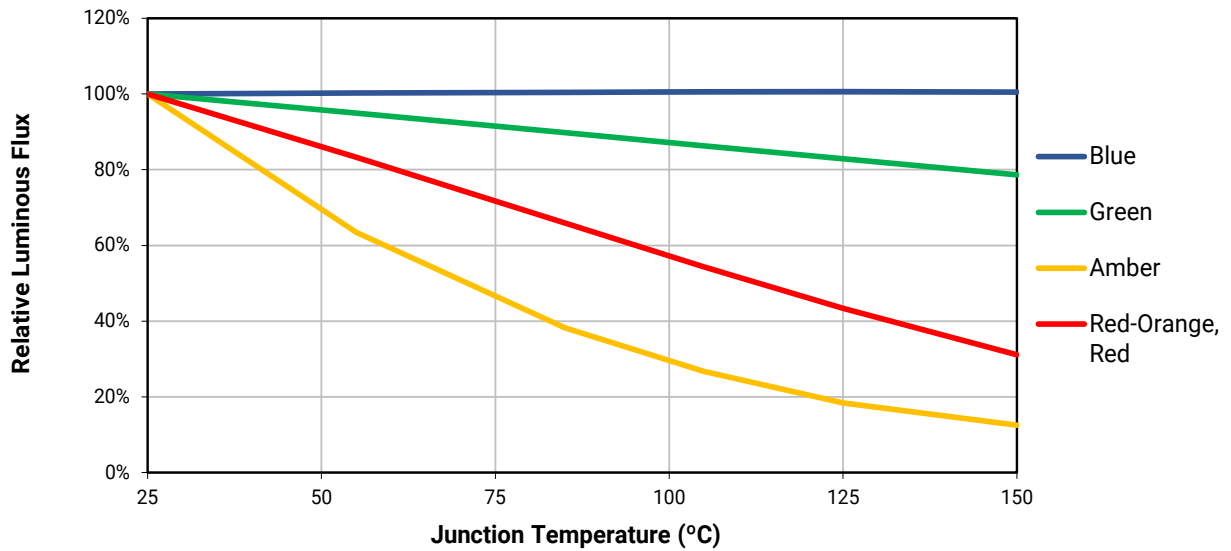

RELATIVE FLUX VS. JUNCTION TEMPERATURE ($I_f = 350 \text{ mA}$) - CONTINUED

Color

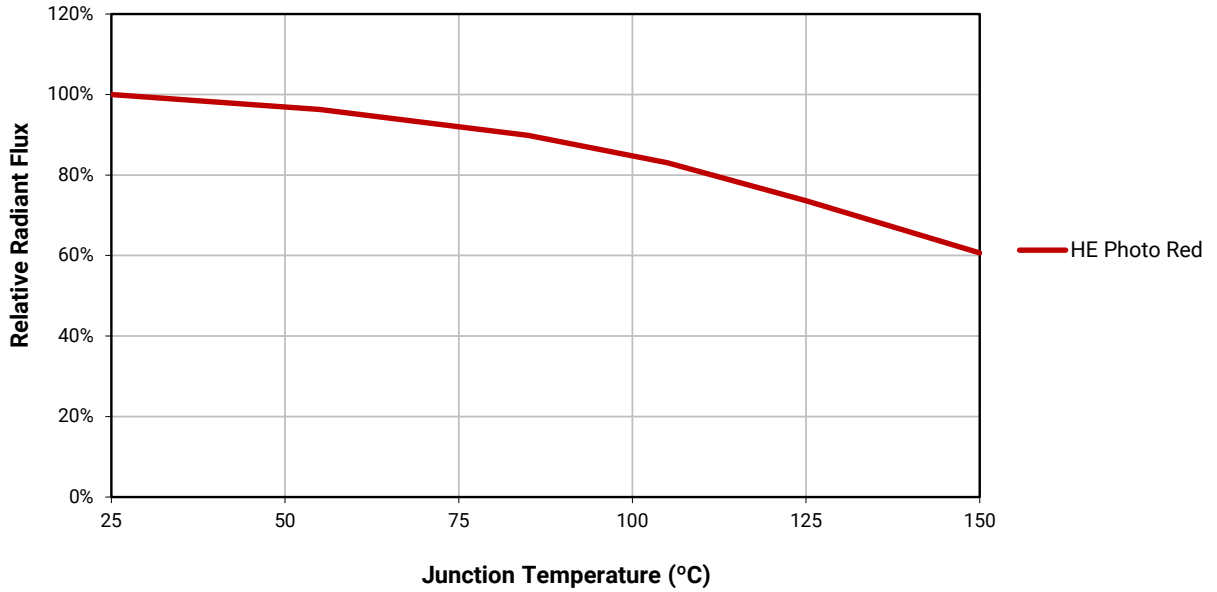

ELECTRICAL CHARACTERISTICS ($T_j = 25 \text{ °C}$)

White

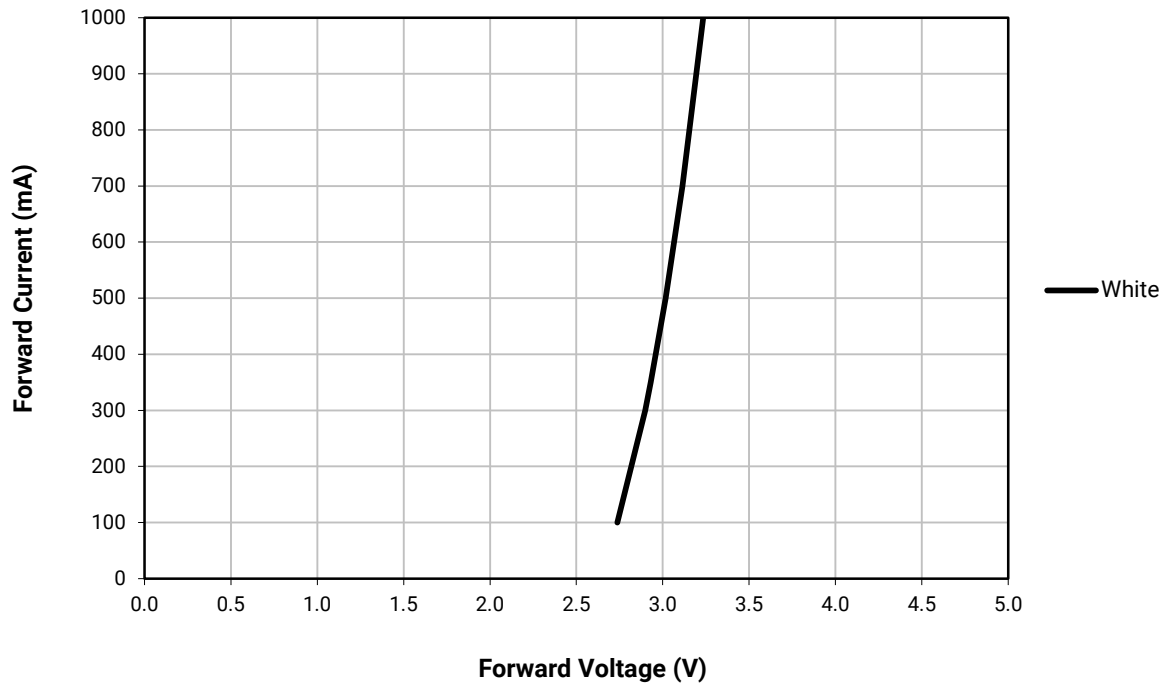

ELECTRICAL CHARACTERISTICS (T_j = 25 °C) - CONTINUED

Color

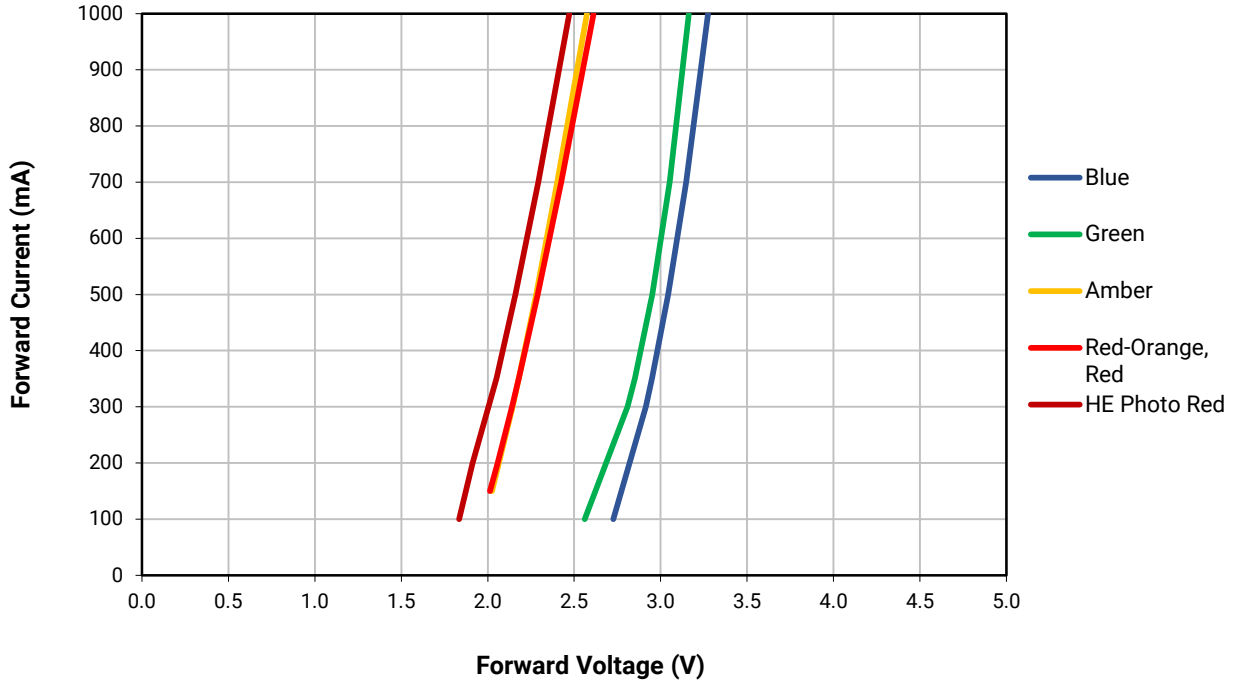

RELATIVE FLUX VS. CURRENT (T_j = 25 °C)

White

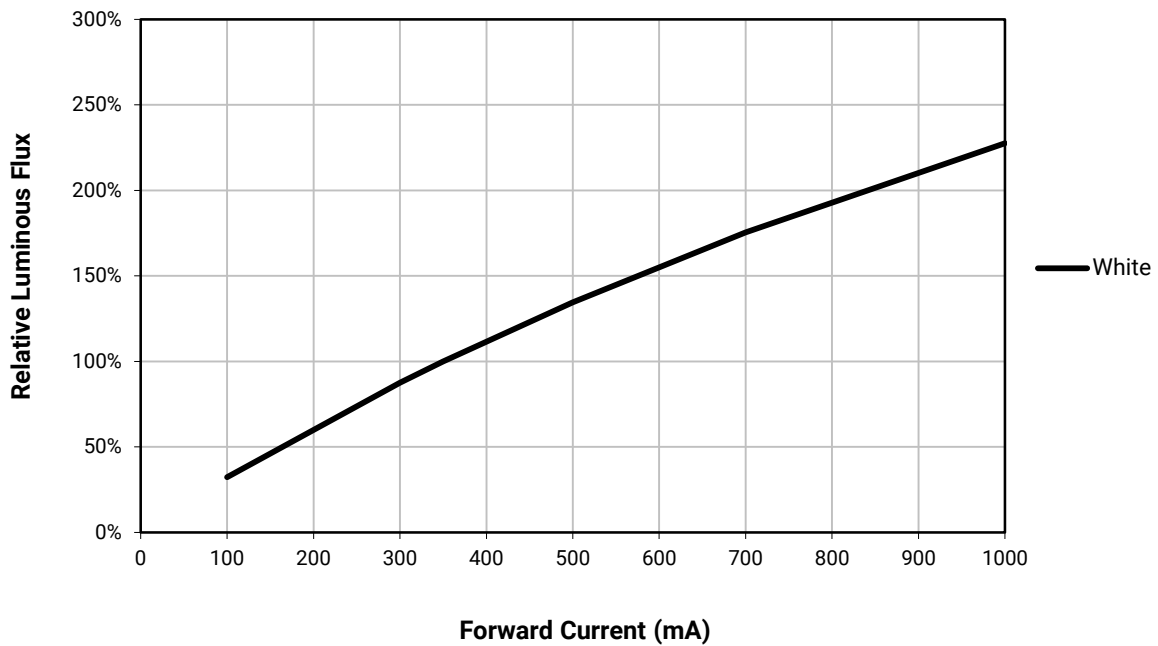

RELATIVE FLUX VS. CURRENT ($T_j = 25\text{ }^\circ\text{C}$) - CONTINUED

Color

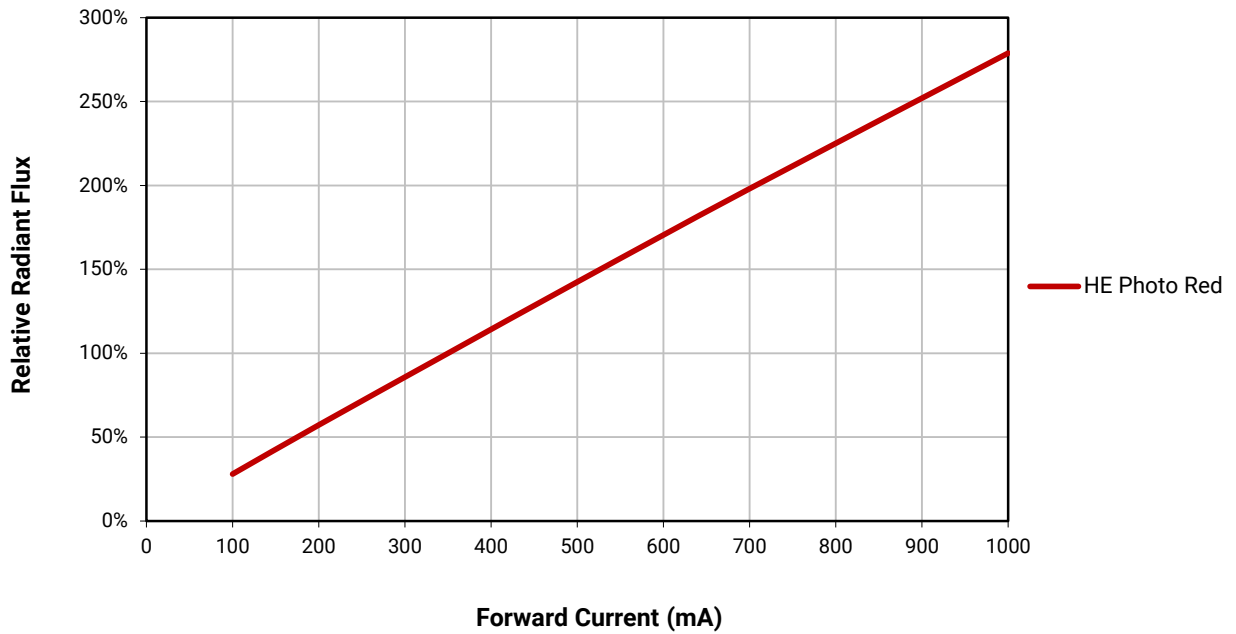
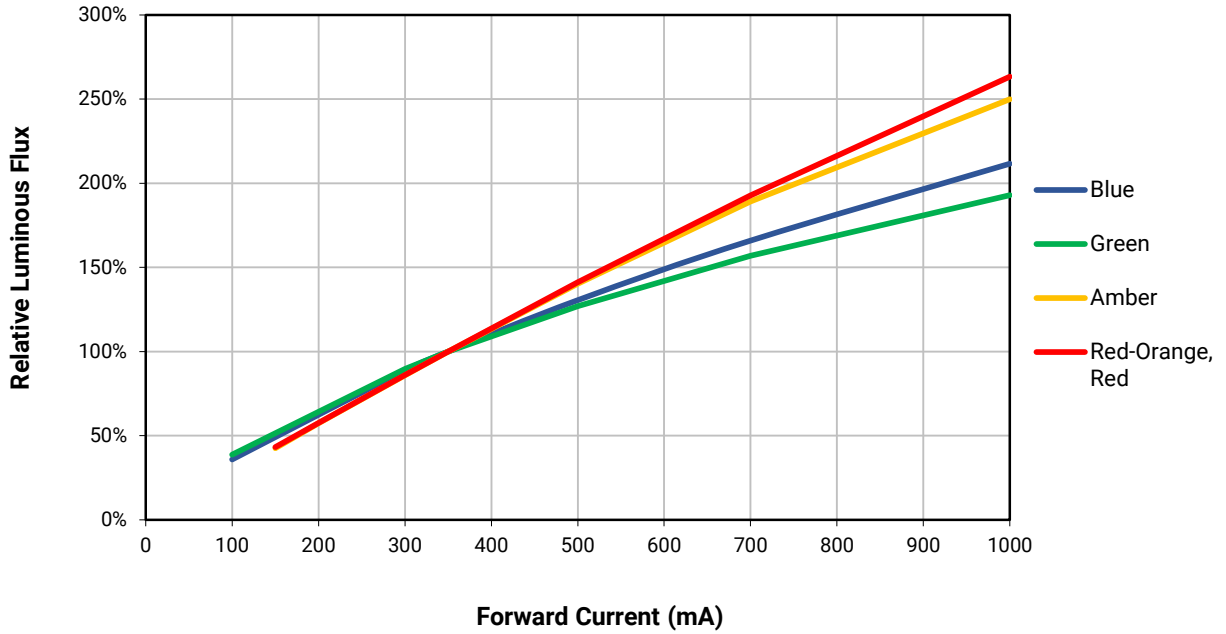

RELATIVE CHROMATICITY VS. CURRENT AND TEMPERATURE - WARM WHITE

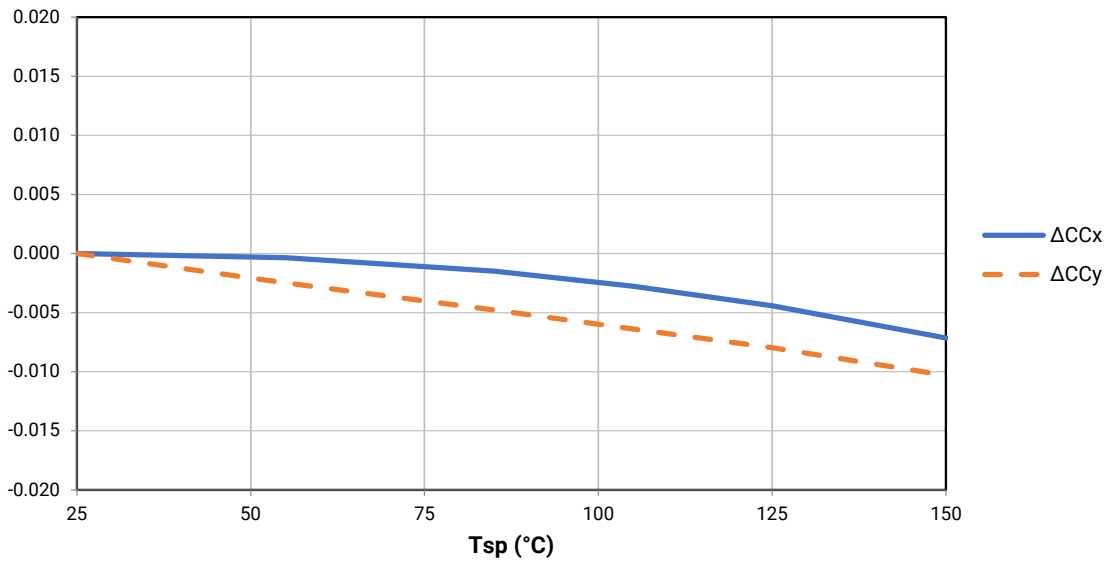
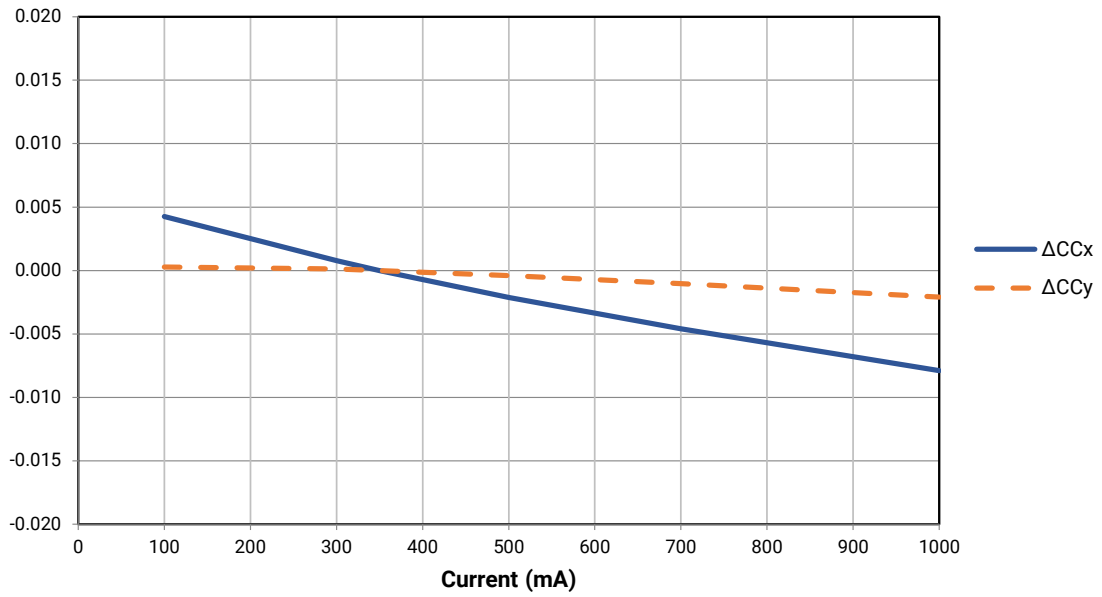

TYPICAL SPATIAL DISTRIBUTION

White

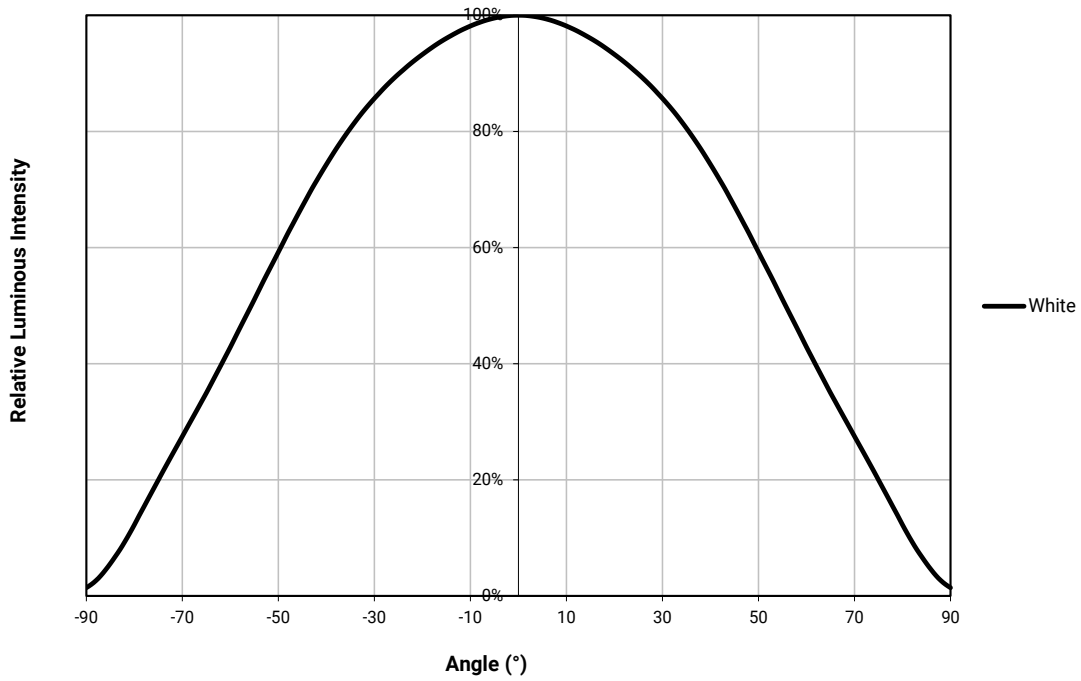

Color

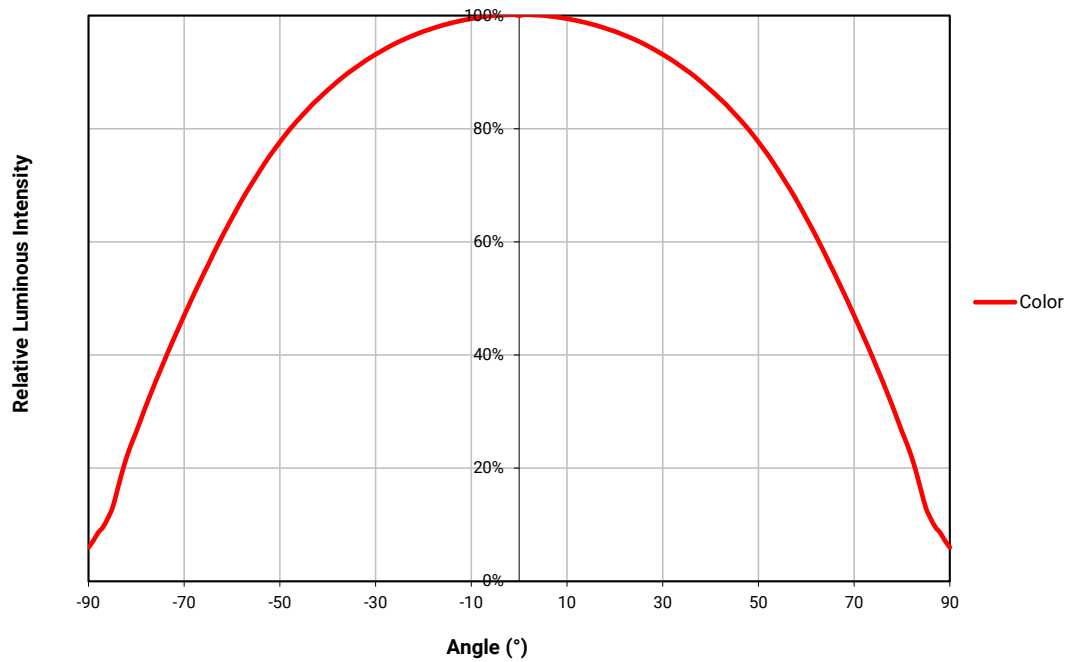

THERMAL DESIGN

The maximum forward current is determined by the thermal resistance between the LED junction and ambient. It is crucial for the end product to be designed in a manner that minimizes the thermal resistance from the solder point to ambient in order to optimize lamp life and optical characteristics.

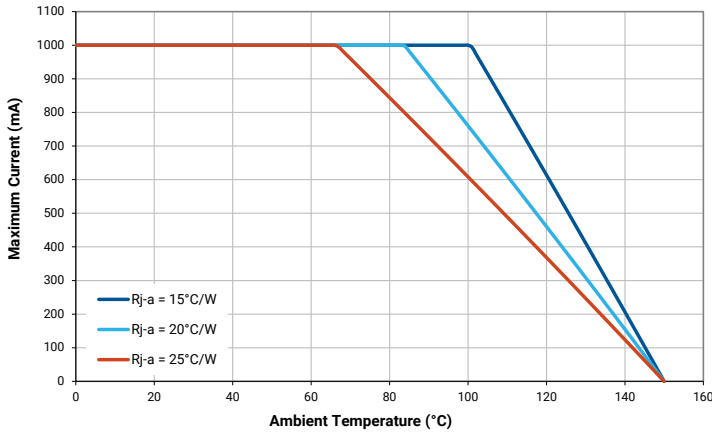

White

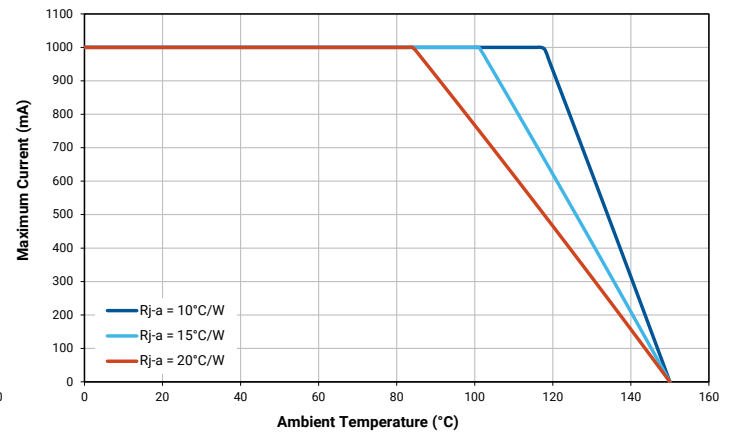

Blue

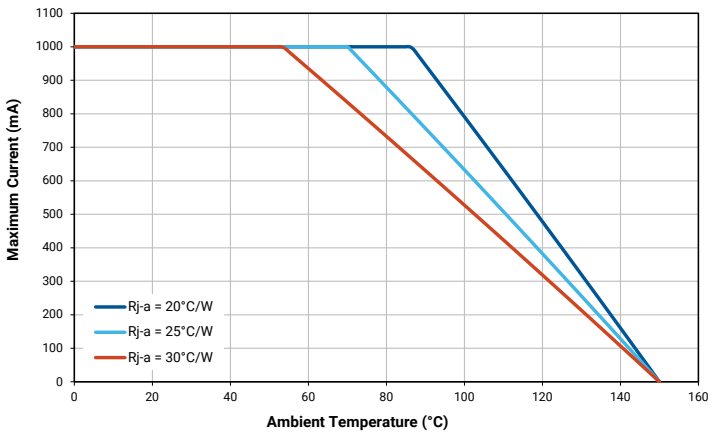

Green

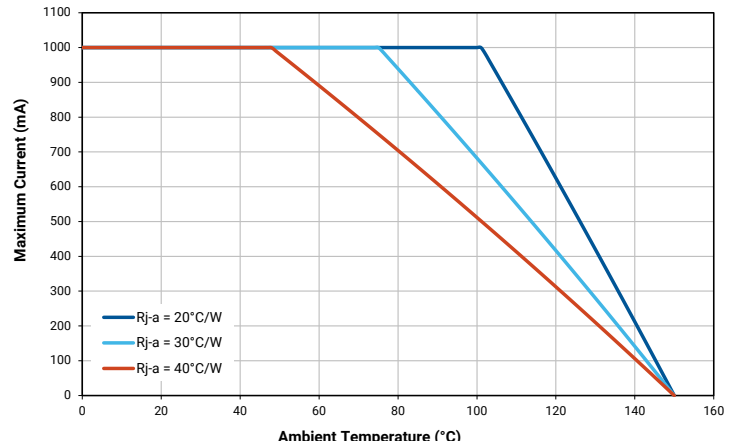

Amber

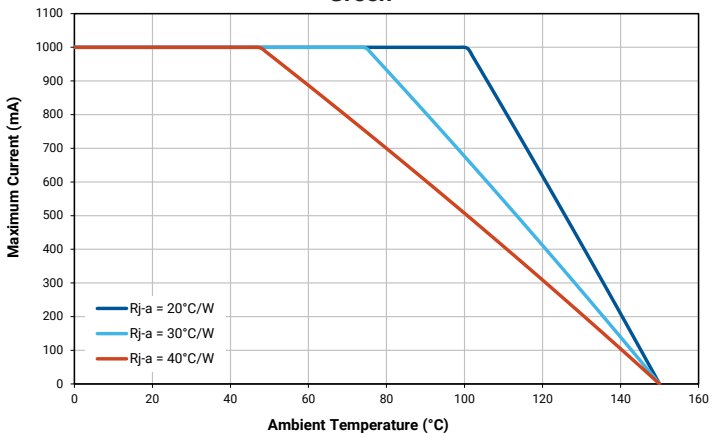

Red-Orange, Red

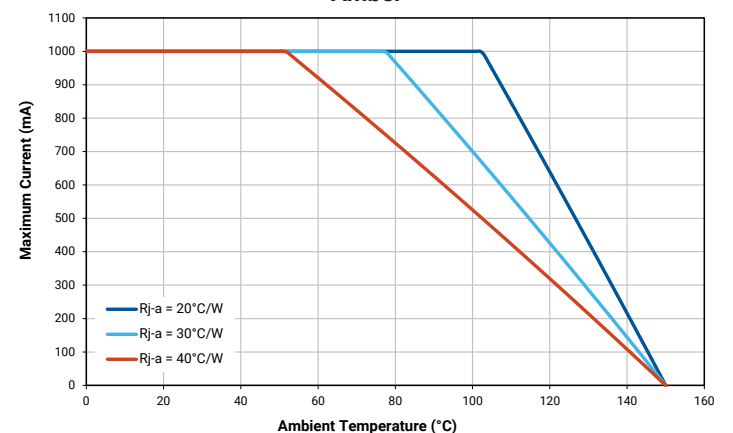

HE Photo Red

PERFORMANCE GROUPS - LUMINOUS FLUX

XLamp XP-E LEDs are tested for luminous flux and placed into one of the following luminous-flux groups:

| Group Code | Minimum Luminous Flux (lm) @ 350 mA | Maximum Luminous Flux (lm) @ 350 mA |
|------------|--|--|
| N3 | 56.8 | 62.0 |
| N4 | 62.0 | 67.2 |
| P2 | 67.2 | 73.9 |
| P3 | 73.9 | 80.6 |
| P4 | 80.6 | 87.4 |
| Q2 | 87.4 | 93.9 |
| Q3 | 93.9 | 100 |
| Q4 | 100 | 107 |
| Q5 | 107 | 114 |
| R2 | 114 | 122 |
| R3 | 122 | 130 |
| R4 | 130 | 139 |
| R5 | 139 | 148 |
| S2 | 148 | 156 |
| S3 | 156 | 164 |
| S4 | 164 | 172 |
| S5 | 172 | 180 |

PERFORMANCE GROUPS - RADIANT FLUX ($T_J = 25\text{ }^\circ\text{C}$)

XLamp XP-E HE photo red LEDs are tested for radiant flux and sorted into one of the following radiant-flux bins:

| Group | Minimum Radiant Flux (mW) @ 350 mA | Maximum Radiant Flux (mW) @ 350 mA |
|-------|---------------------------------------|---------------------------------------|
| 26 | 350 | 375 |
| 27 | 375 | 400 |
| 28 | 400 | 425 |
| 29 | 425 | 450 |

PERFORMANCE GROUPS - CHROMATICITY

White XLamp XP-E LEDs are tested for chromaticity and placed into one of the regions defined by the bounding coordinates on the following pages.

| Region | x | y | Region | x | y |
|--------|------|------|--------|------|------|
| WK | .283 | .284 | WF | .314 | .355 |
| | .295 | .297 | | .316 | .332 |
| | .298 | .288 | | .306 | .322 |
| | .287 | .276 | | .301 | .342 |
| WA | .292 | .306 | WP | .317 | .319 |
| | .295 | .297 | | .329 | .330 |
| | .283 | .284 | | .329 | .318 |
| | .279 | .291 | | .318 | .308 |
| WM | .295 | .297 | WD | .329 | .345 |
| | .308 | .311 | | .329 | .330 |
| | .310 | .300 | | .317 | .319 |
| | .298 | .288 | | .316 | .332 |
| WB | .306 | .322 | WG | .329 | .369 |
| | .308 | .311 | | .329 | .345 |
| | .295 | .297 | | .316 | .332 |
| | .292 | .306 | | .314 | .355 |
| WE | .301 | .342 | WJ | .329 | .330 |
| | .306 | .322 | | .329 | .345 |
| | .292 | .306 | | .346 | .359 |
| | .287 | .321 | | .344 | .342 |
| WN | .308 | .311 | WH | .348 | .384 |
| | .317 | .319 | | .346 | .359 |
| | .318 | .308 | | .329 | .345 |
| | .310 | .300 | | .329 | .369 |
| WC | .316 | .332 | | | |
| | .317 | .319 | | | |
| | .308 | .311 | | | |
| | .306 | .322 | | | |

PERFORMANCE GROUPS - CHROMATICITY (CONTINUED)

| Region | x | y | Region | x | y | Region | x | y | Region | x | y |
|--------|--------|--------|--------|--------|--------|--------|--------|--------|--------|--------|--------|
| 0A | 0.2950 | 0.2970 | 0B | 0.2920 | 0.3060 | 0C | 0.2984 | 0.3133 | 0D | 0.2984 | 0.3133 |
| | 0.2920 | 0.3060 | | 0.2895 | 0.3135 | | 0.2962 | 0.3220 | | 0.3048 | 0.3207 |
| | 0.2984 | 0.3133 | | 0.2962 | 0.3220 | | 0.3028 | 0.3304 | | 0.3068 | 0.3113 |
| | 0.3009 | 0.3042 | | 0.2984 | 0.3133 | | 0.3048 | 0.3207 | | 0.3009 | 0.3042 |
| 0R | 0.2980 | 0.2880 | 0S | 0.2895 | 0.3135 | 0T | 0.2962 | 0.3220 | 0U | 0.3037 | 0.2937 |
| | 0.2950 | 0.2970 | | 0.2870 | 0.3210 | | 0.2937 | 0.3312 | | 0.3009 | 0.3042 |
| | 0.3009 | 0.3042 | | 0.2937 | 0.3312 | | 0.3005 | 0.3415 | | 0.3068 | 0.3113 |
| | 0.3037 | 0.2937 | | 0.2962 | 0.3220 | | 0.3028 | 0.3304 | | 0.3093 | 0.2993 |
| 1A | 0.3048 | 0.3207 | 1B | 0.3028 | 0.3304 | 1C | 0.3115 | 0.3391 | 1D | 0.3130 | 0.3290 |
| | 0.3130 | 0.3290 | | 0.3115 | 0.3391 | | 0.3205 | 0.3481 | | 0.3213 | 0.3373 |
| | 0.3144 | 0.3186 | | 0.3130 | 0.3290 | | 0.3213 | 0.3373 | | 0.3221 | 0.3261 |
| | 0.3068 | 0.3113 | | 0.3048 | 0.3207 | | 0.3130 | 0.3290 | | 0.3144 | 0.3186 |
| 1R | 0.3068 | 0.3113 | 1S | 0.3005 | 0.3415 | 1T | 0.3099 | 0.3509 | 1U | 0.3144 | 0.3186 |
| | 0.3144 | 0.3186 | | 0.3099 | 0.3509 | | 0.3196 | 0.3602 | | 0.3221 | 0.3261 |
| | 0.3161 | 0.3059 | | 0.3115 | 0.3391 | | 0.3205 | 0.3481 | | 0.3231 | 0.3120 |
| | 0.3093 | 0.2993 | | 0.3028 | 0.3304 | | 0.3115 | 0.3391 | | 0.3161 | 0.3059 |
| 2A | 0.3215 | 0.3350 | 2B | 0.3207 | 0.3462 | 2C | 0.3290 | 0.3538 | 2D | 0.3290 | 0.3417 |
| | 0.3290 | 0.3417 | | 0.3290 | 0.3538 | | 0.3376 | 0.3616 | | 0.3371 | 0.3490 |
| | 0.3290 | 0.3300 | | 0.3290 | 0.3417 | | 0.3371 | 0.3490 | | 0.3366 | 0.3369 |
| | 0.3222 | 0.3243 | | 0.3215 | 0.3350 | | 0.3290 | 0.3417 | | 0.3290 | 0.3300 |
| 2R | 0.3222 | 0.3243 | 2S | 0.3196 | 0.3602 | 2T | 0.3290 | 0.3690 | 2U | 0.3290 | 0.3300 |
| | 0.3290 | 0.3300 | | 0.3290 | 0.3690 | | 0.3381 | 0.3762 | | 0.3366 | 0.3369 |
| | 0.3290 | 0.3180 | | 0.3290 | 0.3538 | | 0.3376 | 0.3616 | | 0.3361 | 0.3245 |
| | 0.3231 | 0.3120 | | 0.3207 | 0.3462 | | 0.3290 | 0.3538 | | 0.3290 | 0.3180 |
| 3A | 0.3371 | 0.3490 | 3B | 0.3376 | 0.3616 | 3C | 0.3463 | 0.3687 | 3D | 0.3451 | 0.3554 |
| | 0.3451 | 0.3554 | | 0.3463 | 0.3687 | | 0.3551 | 0.3760 | | 0.3533 | 0.3620 |
| | 0.3440 | 0.3427 | | 0.3451 | 0.3554 | | 0.3533 | 0.3620 | | 0.3515 | 0.3487 |
| | 0.3366 | 0.3369 | | 0.3371 | 0.3490 | | 0.3451 | 0.3554 | | 0.3440 | 0.3427 |
| 3R | 0.3366 | 0.3369 | 3S | 0.3381 | 0.3762 | | | | | | |
| | 0.3440 | 0.3428 | | 0.3480 | 0.3840 | | | | | | |
| | 0.3429 | 0.3307 | | 0.3463 | 0.3687 | | | | | | |
| | 0.3361 | 0.3245 | | 0.3376 | 0.3616 | | | | | | |
| 4A | 0.3530 | 0.3597 | 4B | 0.3548 | 0.3736 | 4C | 0.3641 | 0.3804 | 4D | 0.3615 | 0.3659 |
| | 0.3615 | 0.3659 | | 0.3641 | 0.3804 | | 0.3736 | 0.3874 | | 0.3702 | 0.3722 |
| | 0.3590 | 0.3521 | | 0.3615 | 0.3659 | | 0.3702 | 0.3722 | | 0.3670 | 0.3578 |
| | 0.3512 | 0.3465 | | 0.3530 | 0.3597 | | 0.3615 | 0.3659 | | 0.3590 | 0.3521 |
| 5A1 | 0.3670 | 0.3578 | 5A2 | 0.3686 | 0.3649 | 5A3 | 0.3744 | 0.3685 | 5A4 | 0.3726 | 0.3612 |
| | 0.3686 | 0.3649 | | 0.3702 | 0.3722 | | 0.3763 | 0.3760 | | 0.3744 | 0.3685 |
| | 0.3744 | 0.3685 | | 0.3763 | 0.3760 | | 0.3825 | 0.3798 | | 0.3804 | 0.3721 |
| | 0.3726 | 0.3612 | | 0.3744 | 0.3685 | | 0.3804 | 0.3721 | | 0.3783 | 0.3646 |

PERFORMANCE GROUPS - CHROMATICITY (CONTINUED)

| Region | x | y | Region | x | y | Region | x | y | Region | x | y |
|--------|--------|--------|--------|--------|--------|--------|--------|--------|--------|--------|--------|
| 5B1 | 0.3702 | 0.3722 | 5B2 | 0.3719 | 0.3797 | 5B3 | 0.3782 | 0.3837 | 5B4 | 0.3763 | 0.3760 |
| | 0.3719 | 0.3797 | | 0.3736 | 0.3874 | | 0.3802 | 0.3916 | | 0.3782 | 0.3837 |
| | 0.3782 | 0.3837 | | 0.3802 | 0.3916 | | 0.3869 | 0.3958 | | 0.3847 | 0.3877 |
| | 0.3763 | 0.3760 | | 0.3782 | 0.3837 | | 0.3847 | 0.3877 | | 0.3825 | 0.3798 |
| 5C1 | 0.3825 | 0.3798 | 5C2 | 0.3847 | 0.3877 | 5C3 | 0.3912 | 0.3917 | 5C4 | 0.3887 | 0.3836 |
| | 0.3847 | 0.3877 | | 0.3869 | 0.3958 | | 0.3937 | 0.4001 | | 0.3912 | 0.3917 |
| | 0.3912 | 0.3917 | | 0.3937 | 0.4001 | | 0.4006 | 0.4044 | | 0.3978 | 0.3958 |
| | 0.3887 | 0.3836 | | 0.3912 | 0.3917 | | 0.3978 | 0.3958 | | 0.3950 | 0.3875 |
| 5D1 | 0.3783 | 0.3646 | 5D2 | 0.3804 | 0.3721 | 5D3 | 0.3863 | 0.3758 | 5D4 | 0.3840 | 0.3681 |
| | 0.3804 | 0.3721 | | 0.3825 | 0.3798 | | 0.3887 | 0.3836 | | 0.3863 | 0.3758 |
| | 0.3863 | 0.3758 | | 0.3887 | 0.3836 | | 0.3950 | 0.3875 | | 0.3924 | 0.3794 |
| | 0.3840 | 0.3681 | | 0.3863 | 0.3758 | | 0.3924 | 0.3794 | | 0.3898 | 0.3716 |
| 6A1 | 0.3889 | 0.3690 | 6A2 | 0.3915 | 0.3768 | 6A3 | 0.3981 | 0.3800 | 6A4 | 0.3953 | 0.3720 |
| | 0.3915 | 0.3768 | | 0.3941 | 0.3848 | | 0.4010 | 0.3882 | | 0.3981 | 0.3800 |
| | 0.3981 | 0.3800 | | 0.4010 | 0.3882 | | 0.4080 | 0.3916 | | 0.4048 | 0.3832 |
| | 0.3953 | 0.3720 | | 0.3981 | 0.3800 | | 0.4048 | 0.3832 | | 0.4017 | 0.3751 |
| 6B1 | 0.3941 | 0.3848 | 6B2 | 0.3968 | 0.3930 | 6B3 | 0.4040 | 0.3966 | 6B4 | 0.4010 | 0.3882 |
| | 0.3968 | 0.3930 | | 0.3996 | 0.4015 | | 0.4071 | 0.4052 | | 0.4040 | 0.3966 |
| | 0.4040 | 0.3966 | | 0.4071 | 0.4052 | | 0.4146 | 0.4089 | | 0.4113 | 0.4001 |
| | 0.4010 | 0.3882 | | 0.4040 | 0.3966 | | 0.4113 | 0.4001 | | 0.4080 | 0.3916 |
| 6C1 | 0.4080 | 0.3916 | 6C2 | 0.4113 | 0.4001 | 6C3 | 0.4186 | 0.4037 | 6C4 | 0.4150 | 0.3950 |
| | 0.4113 | 0.4001 | | 0.4146 | 0.4089 | | 0.4222 | 0.4127 | | 0.4186 | 0.4037 |
| | 0.4186 | 0.4037 | | 0.4222 | 0.4127 | | 0.4299 | 0.4165 | | 0.4259 | 0.4073 |
| | 0.4150 | 0.3950 | | 0.4186 | 0.4037 | | 0.4259 | 0.4073 | | 0.4221 | 0.3984 |
| 6D1 | 0.4017 | 0.3751 | 6D2 | 0.4048 | 0.3832 | 6D3 | 0.4116 | 0.3865 | 6D4 | 0.4082 | 0.3782 |
| | 0.4048 | 0.3832 | | 0.4080 | 0.3916 | | 0.4150 | 0.3950 | | 0.4116 | 0.3865 |
| | 0.4116 | 0.3865 | | 0.4150 | 0.3950 | | 0.4221 | 0.3984 | | 0.4183 | 0.3898 |
| | 0.4082 | 0.3782 | | 0.4116 | 0.3865 | | 0.4183 | 0.3898 | | 0.4147 | 0.3814 |
| 7A1 | 0.4147 | 0.3814 | 7A2 | 0.4183 | 0.3898 | 7A3 | 0.4242 | 0.3919 | 7A4 | 0.4203 | 0.3833 |
| | 0.4183 | 0.3898 | | 0.4221 | 0.3984 | | 0.4281 | 0.4006 | | 0.4242 | 0.3919 |
| | 0.4242 | 0.3919 | | 0.4281 | 0.4006 | | 0.4342 | 0.4028 | | 0.4300 | 0.3939 |
| | 0.4203 | 0.3833 | | 0.4242 | 0.3919 | | 0.4300 | 0.3939 | | 0.4259 | 0.3853 |
| 7B1 | 0.4221 | 0.3984 | 7B2 | 0.4259 | 0.4073 | 7B3 | 0.4322 | 0.4096 | 7B4 | 0.4281 | 0.4006 |
| | 0.4259 | 0.4073 | | 0.4299 | 0.4165 | | 0.4364 | 0.4188 | | 0.4322 | 0.4096 |
| | 0.4322 | 0.4096 | | 0.4364 | 0.4188 | | 0.4430 | 0.4212 | | 0.4385 | 0.4119 |
| | 0.4281 | 0.4006 | | 0.4322 | 0.4096 | | 0.4385 | 0.4119 | | 0.4342 | 0.4028 |
| 7C1 | 0.4342 | 0.4028 | 7C2 | 0.4385 | 0.4119 | 7C3 | 0.4449 | 0.4141 | 7C4 | 0.4403 | 0.4049 |
| | 0.4385 | 0.4119 | | 0.4430 | 0.4212 | | 0.4496 | 0.4236 | | 0.4449 | 0.4141 |
| | 0.4449 | 0.4141 | | 0.4496 | 0.4236 | | 0.4562 | 0.4260 | | 0.4513 | 0.4164 |
| | 0.4403 | 0.4049 | | 0.4449 | 0.4141 | | 0.4513 | 0.4164 | | 0.4465 | 0.4071 |

PERFORMANCE GROUPS - CHROMATICITY (CONTINUED)

| Region | x | y | Region | x | y | Region | x | y | Region | x | y |
|--------|--------|--------|--------|--------|--------|--------|--------|--------|--------|--------|--------|
| 7D1 | 0.4259 | 0.3853 | 7D2 | 0.4300 | 0.3939 | 7D3 | 0.4359 | 0.3960 | 7D4 | 0.4316 | 0.3873 |
| | 0.4300 | 0.3939 | | 0.4342 | 0.4028 | | 0.4403 | 0.4049 | | 0.4359 | 0.3960 |
| | 0.4359 | 0.3960 | | 0.4403 | 0.4049 | | 0.4465 | 0.4071 | | 0.4418 | 0.3981 |
| | 0.4316 | 0.3873 | | 0.4359 | 0.3960 | | 0.4418 | 0.3981 | | 0.4373 | 0.3893 |
| 8A1 | 0.4373 | 0.3893 | 8A2 | 0.4418 | 0.3981 | 8A3 | 0.4475 | 0.3994 | 8A4 | 0.4428 | 0.3906 |
| | 0.4418 | 0.3981 | | 0.4465 | 0.4071 | | 0.4523 | 0.4085 | | 0.4475 | 0.3994 |
| | 0.4475 | 0.3994 | | 0.4523 | 0.4085 | | 0.4582 | 0.4099 | | 0.4532 | 0.4008 |
| | 0.4428 | 0.3906 | | 0.4475 | 0.3994 | | 0.4532 | 0.4008 | | 0.4483 | 0.3919 |
| 8B1 | 0.4465 | 0.4071 | 8B2 | 0.4513 | 0.4164 | 8B3 | 0.4573 | 0.4178 | 8B4 | 0.4523 | 0.4085 |
| | 0.4513 | 0.4164 | | 0.4562 | 0.4260 | | 0.4624 | 0.4274 | | 0.4573 | 0.4178 |
| | 0.4573 | 0.4178 | | 0.4624 | 0.4274 | | 0.4687 | 0.4289 | | 0.4634 | 0.4193 |
| | 0.4523 | 0.4085 | | 0.4573 | 0.4178 | | 0.4634 | 0.4193 | | 0.4582 | 0.4099 |
| 8C1 | 0.4582 | 0.4099 | 8C2 | 0.4634 | 0.4193 | 8C3 | 0.4695 | 0.4207 | 8C4 | 0.4641 | 0.4112 |
| | 0.4634 | 0.4193 | | 0.4687 | 0.4289 | | 0.4750 | 0.4304 | | 0.4695 | 0.4207 |
| | 0.4695 | 0.4207 | | 0.4750 | 0.4304 | | 0.4813 | 0.4319 | | 0.4756 | 0.4221 |
| | 0.4641 | 0.4112 | | 0.4695 | 0.4207 | | 0.4756 | 0.4221 | | 0.4700 | 0.4126 |
| 8D1 | 0.4483 | 0.3919 | 8D2 | 0.4532 | 0.4008 | 8D3 | 0.4589 | 0.4021 | 8D4 | 0.4538 | 0.3931 |
| | 0.4532 | 0.4008 | | 0.4582 | 0.4099 | | 0.4641 | 0.4112 | | 0.4589 | 0.4021 |
| | 0.4589 | 0.4021 | | 0.4641 | 0.4112 | | 0.4700 | 0.4126 | | 0.4646 | 0.4034 |
| | 0.4538 | 0.3931 | | 0.4589 | 0.4021 | | 0.4646 | 0.4034 | | 0.4593 | 0.3944 |

PERFORMANCE GROUPS - DOMINANT WAVELENGTH

Color XLamp XP-E LEDs are tested for dominant wavelength (DWL) and sorted into one of the DWL bins defined below.

| Color | DWL Group | Minimum DWL (nm) @ 350 mA | Maximum DWL (nm) @ 350 mA |
|------------|-----------|------------------------------|------------------------------|
| Blue | B3 | 465 | 470 |
| | B4 | 470 | 475 |
| | B5 | 475 | 480 |
| | B6 | 480 | 485 |
| Green | G2 | 520 | 525 |
| | G3 | 525 | 530 |
| | G4 | 530 | 535 |
| Amber | A2 | 585 | 590 |
| | A3 | 590 | 595 |
| Red-Orange | O3 | 610 | 615 |
| | O4 | 615 | 620 |
| Red | R2 | 620 | 625 |
| | R3 | 625 | 630 |

PERFORMANCE GROUPS - PEAK WAVELENGTH

XLamp XP-E HE photo red LEDs are tested for peak wavelength (PWL) and sorted into one of the PWL bins defined below.

| Color | PWL Group | Minimum PWL (nm) @ 350 mA | Maximum PWL (nm) @ 350 mA |
|--------------|-----------|------------------------------|------------------------------|
| HE Photo Red | P2 | 650 | 655 |
| | P3 | 655 | 660 |
| | P4 | 660 | 665 |
| | P5 | 665 | 670 |

PERFORMANCE GROUPS - FORWARD VOLTAGE

XLamp XP-E amber, red-orange and red LEDs are tested for forward voltage and sorted into one of the forward voltage bins defined below.

| Forward Voltage Group | Minimum Forward Voltage (V) @ 350 mA | Maximum Forward Voltage (V) @ 350 mA |
|-----------------------|---|---|
| A | 1.5 | 1.75 |
| B | 1.75 | 2.0 |
| C | 2.0 | 2.25 |
| D | 2.25 | 2.5 |
| E | 2.5 | 2.75 |
| F | 2.75 | 3.0 |
| G | 3.0 | 3.25 |
| H | 3.25 | 3.5 |
| J | 3.5 | 3.75 |

STANDARD COOL WHITE KITS PLOTTED ON ANSI STANDARD CHROMATICITY REGIONS

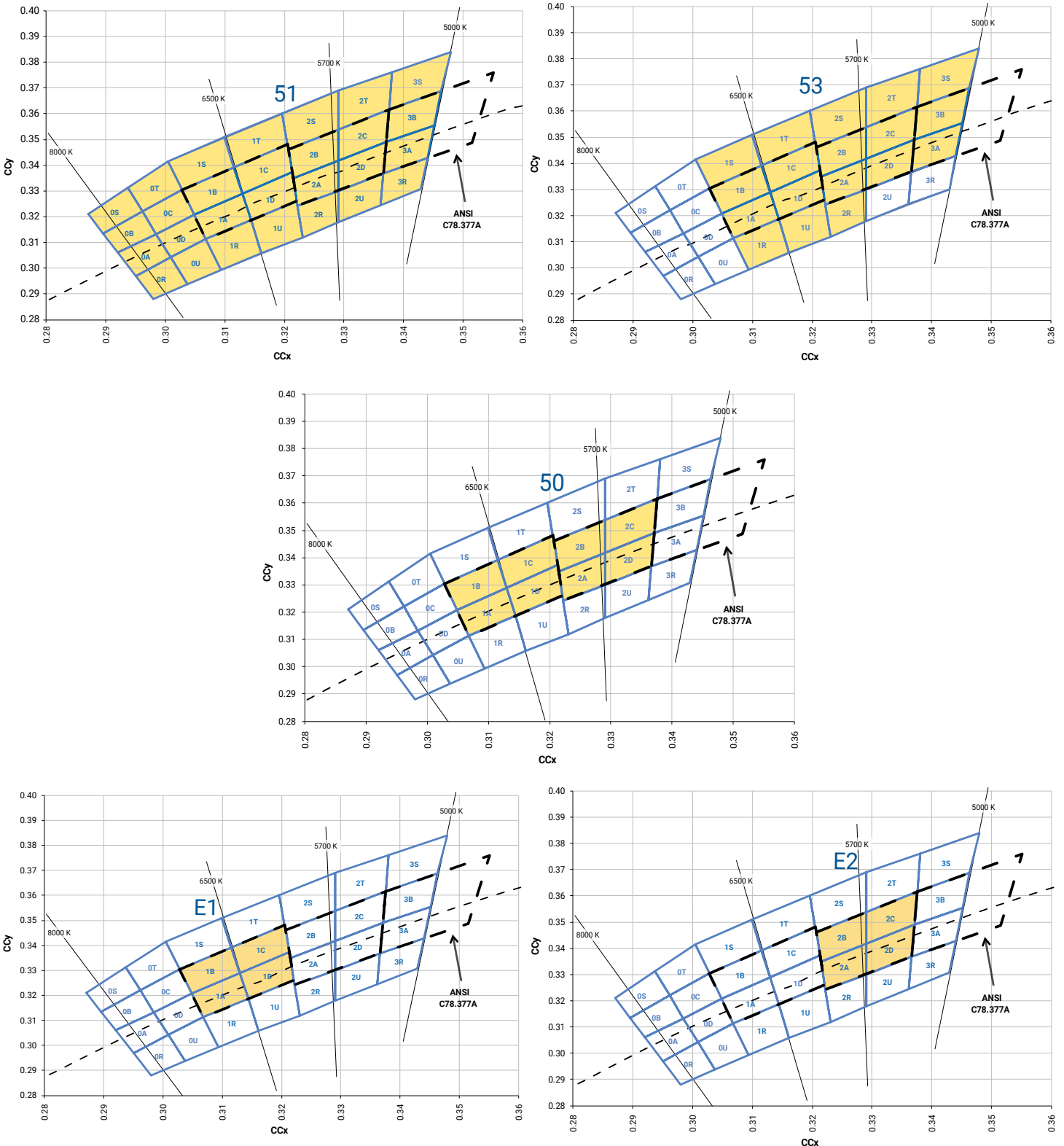

STANDARD WARM AND NEUTRAL WHITE KITS PLOTTED ON ANSI STANDARD CHROMATICITY REGIONS

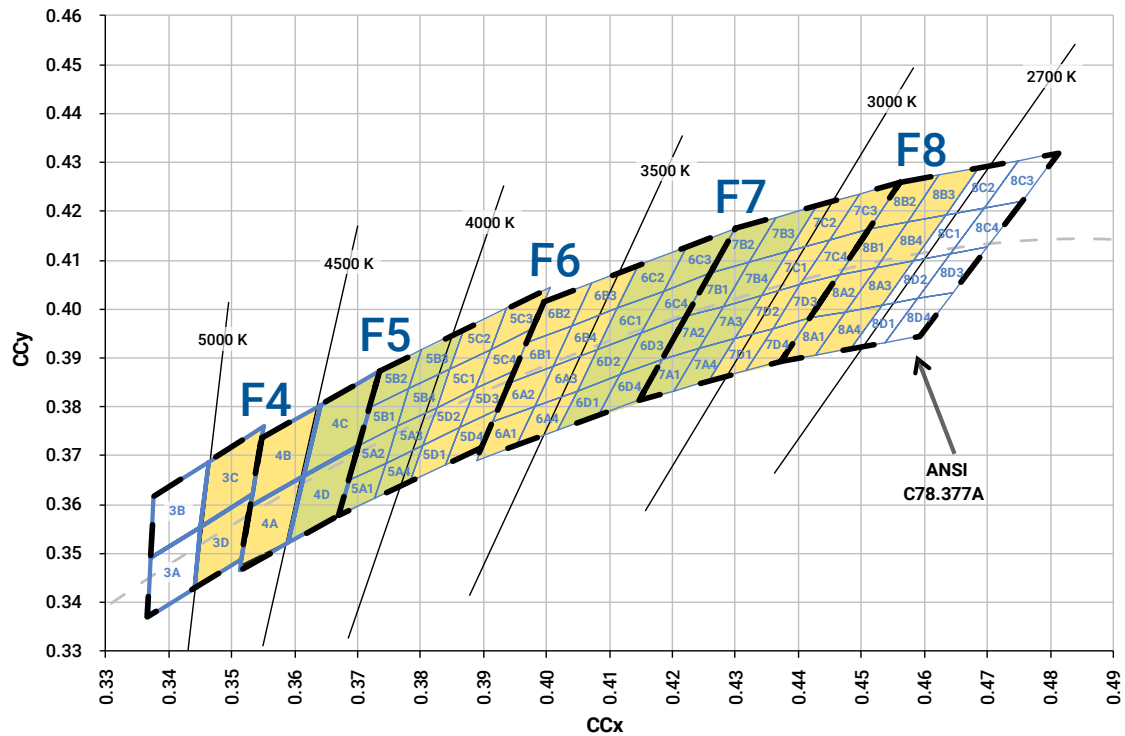
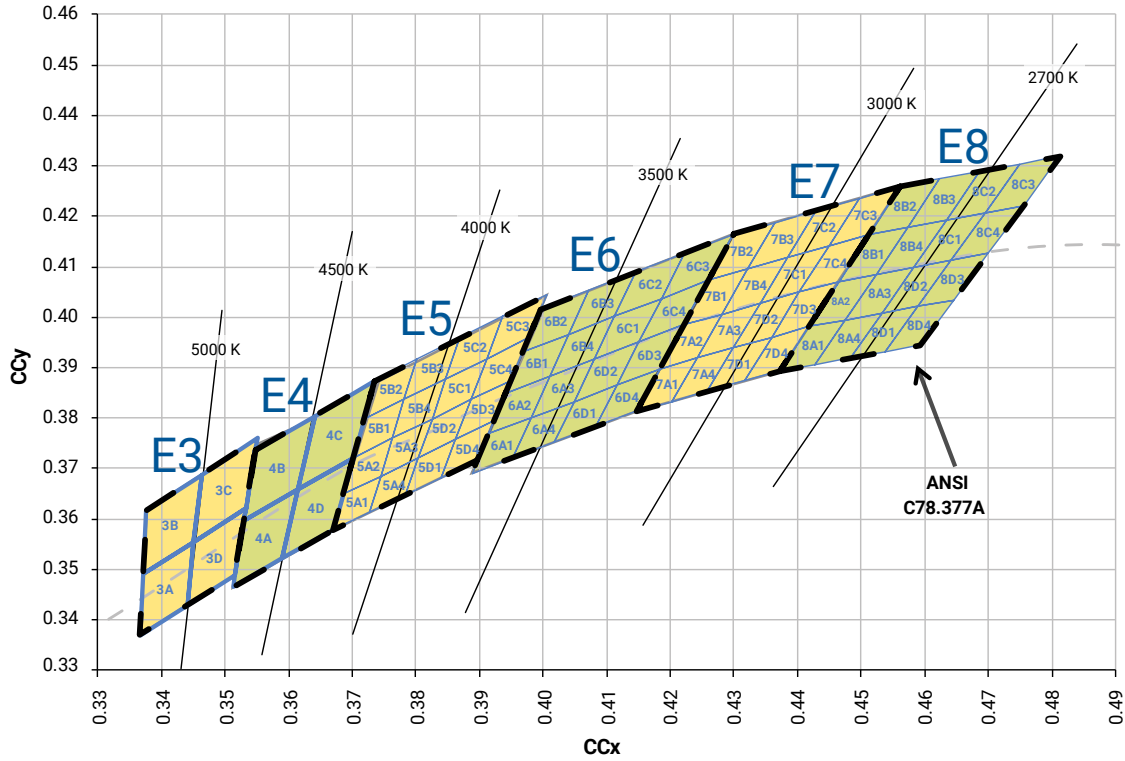

STANDARD WARM AND NEUTRAL WHITE KITS PLOTTED ON ANSI STANDARD CHROMATICITY REGIONS - CONTINUED

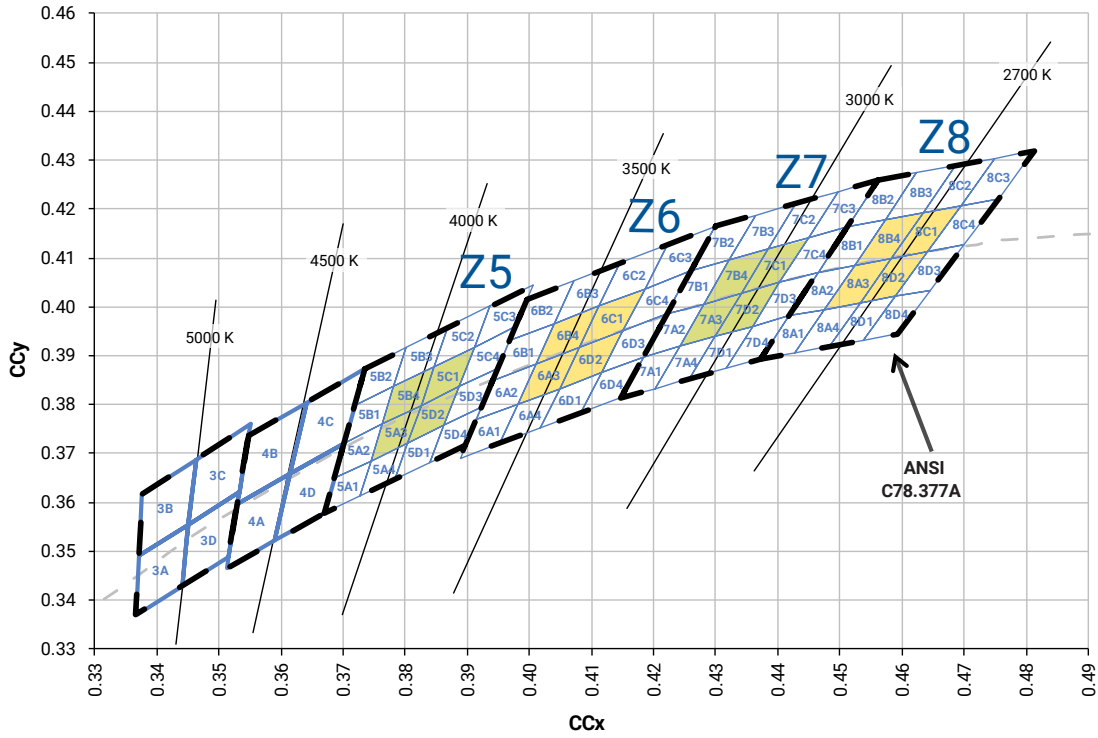

STANDARD CHROMATICITY KITS

The following table provides the chromaticity bins associated with chromaticity kits.

| Color | CCT | Kit | Chromaticity Bins |
|---------------|--------|-----|--|
| Cool White | 6200 K | 51 | 0A, 0B, 0C, 0D, 0R, 0S, 0T, 0U, 1A, 1B, 1C, 1D, 1R, 1S, 1T, 1U, 2A, 2B, 2C, 2D, 2R, 2S, 2T, 2U, 3A, 3B, 3R, 3S |
| | 6000 K | 53 | 1A, 1B, 1C, 1D, 1R, 1S, 1T, 1U, 2A, 2B, 2C, 2D, 2R, 2S, 2T, 3A, 3B, 3S |
| | 6200 K | 50 | 1A, 1B, 1C, 1D, 2A, 2B, 2C, 2D |
| | 6500 K | E1 | 1A, 1B, 1C, 1D |
| | 5700 K | E2 | 2A, 2B, 2C, 2D |
| Neutral White | 5000 K | E3 | 3A, 3B, 3C, 3D |
| | 4750 K | F4 | 3C, 3D, 4A, 4B |
| | 4500 K | E4 | 4A, 4B, 4C, 4D |
| | 4250 K | F5 | 4C, 4D, 5A1, 5A2, 5A3, 5A4, 5B1, 5B2, 5B3, 5B4 |
| | 4000 K | E5 | 5A1, 5A2, 5A3, 5A4, 5B1, 5B2, 5B3, 5B4, 5C1, 5C2, 5C3, 5C4, 5D1, 5D2, 5D3, 5D4 |
| | 4000 K | Z5 | 5A3, 5B4, 5C1, 5D2 |
| Warm White | 3750 K | F6 | 5C1, 5C2, 5C3, 5C4, 5D1, 5D2, 5D3, 5D4, 6A1, 6A2, 6A3, 6A4, 6B1, 6B2, 6B3, 6B4 |
| | 3500 K | E6 | 6A1, 6A2, 6A3, 6A4, 6B1, 6B2, 6B3, 6B4, 6C1, 6C2, 6C3, 6C4, 6D1, 6D2, 6D3, 6D4 |
| | 3500 K | Z6 | 6A3, 6B4, 6C1, 6D2 |
| | 3250 K | F7 | 6C1, 6C2, 6C3, 6C4, 6D1, 6D2, 6D3, 6D4, 7A1, 7A2, 7A3, 7A4, 7B1, 7B2, 7B3, 7B4 |
| | 3000 K | E7 | 7A1, 7A2, 7A3, 7A4, 7B1, 7B2, 7B3, 7B4, 7C1, 7C2, 7C3, 7C4, 7D1, 7D2, 7D3, 7D4 |
| | 3000 K | Z7 | 7A3, 7B4, 7C1, 7D2 |
| | 2850 K | F8 | 7C1, 7C2, 7C3, 7C4, 7D1, 7D2, 7D3, 7D4, 8A1, 8A2, 8A3, 8A4, 8B1, 8B2, 8B3, 8B4 |
| | 2700 K | E8 | 8A1, 8A2, 8A3, 8A4, 8B1, 8B2, 8B3, 8B4, 8C1, 8C2, 8C3, 8C4, 8D1, 8D2, 8D3, 8D4 |
| | 2700 K | Z8 | 8A3, 8B4, 8C1, 8D2 |

BIN AND ORDER CODE FORMATS

XP-E bin codes and order codes are configured in the following manner:

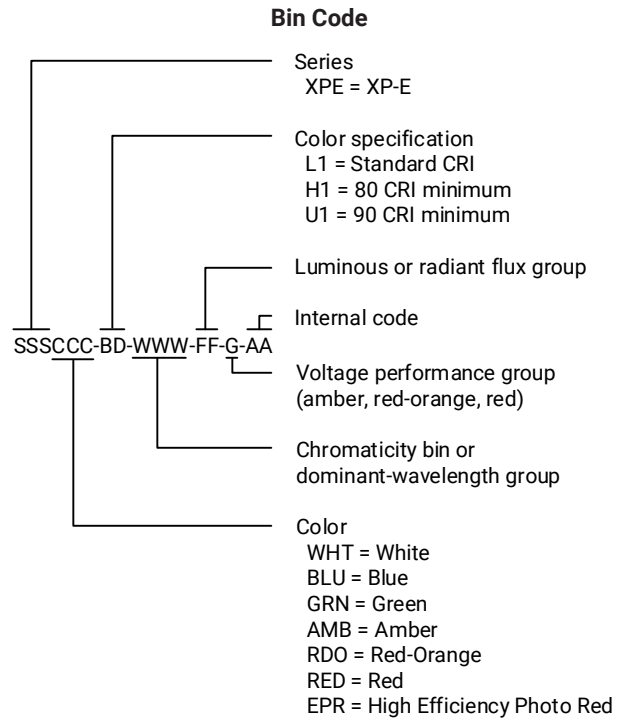
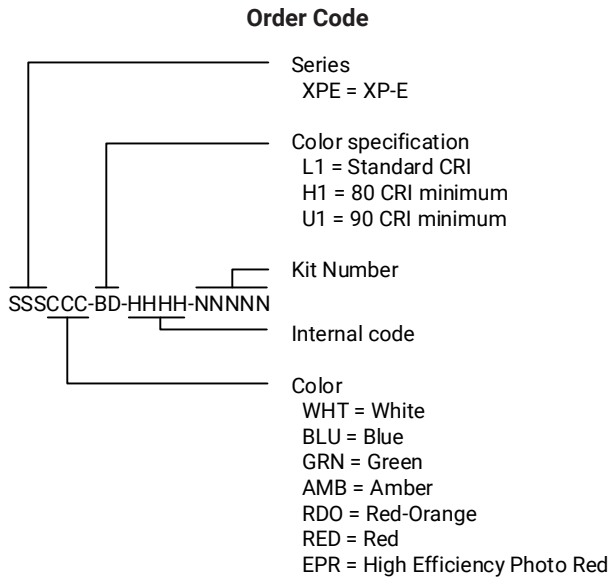

REFLOW SOLDERING CHARACTERISTICS

In testing, Cree LED has found XLamp XP-E LEDs to be compatible with JEDEC J-STD-020C, using the parameters listed below. As a general guideline, Cree LED recommends that users follow the recommended soldering profile provided by the manufacturer of the solder paste used, and therefore it is the lamp or luminaire manufacturer’s responsibility to determine applicable soldering requirements.

Note that this general guideline may not apply to all PCB designs and configurations of reflow soldering equipment.

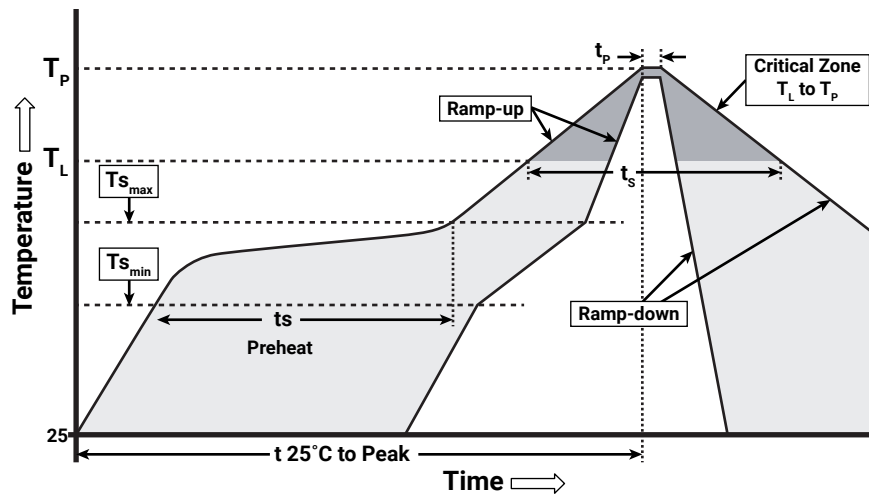

IPC/JEDEC J-STD-020C

| Profile Feature | Lead-Free Solder |
|---|------------------|
| Average Ramp-Up Rate ($T_{s_{max}}$ to T_p) | 1.2 °C/second |
| Preheat: Temperature Min ($T_{s_{min}}$) | 120 °C |
| Preheat: Temperature Max ($T_{s_{max}}$) | 170 °C |
| Preheat: Time ($t_{s_{min}}$ to $t_{s_{max}}$) | 65-150 seconds |
| Time Maintained Above: Temperature (T_L) | 217 °C |
| Time Maintained Above: Time (t_L) | 45-90 seconds |
| Peak/Classification Temperature (T_p) | 235 - 245 °C |
| Time Within 5 °C of Actual Peak Temperature (t_p) | 20-40 seconds |
| Ramp-Down Rate | 1 - 6 °C/second |
| Time 25 °C to Peak Temperature | 4 minutes max. |

Note: All temperatures refer to topside of the package, measured on the package body surface.

NOTES

Measurements

The luminous flux, radiant power, chromaticity, forward voltage and CRI measurements in this document are binning specifications only and solely represent product measurements as of the date of shipment. These measurements will change over time based on a number of factors that are not within Cree LED's control and are not intended or provided as operational specifications for the products. Calculated values are provided for informational purposes only and are not intended or provided as specifications.

Pre-Release Qualification Testing

Please read the [LED Reliability Overview](#) for details of the qualification process Cree LED applies to ensure long-term reliability for XLamp LEDs and details of Cree LED's pre-release qualification testing for XLamp LEDs.

Lumen Maintenance

Cree LED now uses standardized IES LM-80-08 and TM-21-11 methods for collecting long-term data and extrapolating LED lumen maintenance. For information on the specific LM-80 data sets available for this LED, refer to the public [LM-80 results document](#).

Please read the [Long-Term Lumen Maintenance application note](#) for more details on Cree LED's lumen maintenance testing and forecasting. Please read the [Thermal Management application note](#) for details on how thermal design, ambient temperature, and drive current affect the LED junction temperature.

Moisture Sensitivity

Cree LED recommends keeping XLamp LEDs in the provided, resealable moisture-barrier packaging (MBP) until immediately prior to soldering. Unopened MBPs that contain XLamp LEDs do not need special storage for moisture sensitivity.

Once the MBP is opened, XLamp XP-E LEDs may be stored as MSL 1 per JEDEC J-STD-033, meaning they have unlimited floor life in conditions of ≤ 30 °C/85% relative humidity (RH). Regardless of the storage condition, Cree LED recommends sealing any unsoldered LEDs in the original MBP.

RoHS Compliance

The levels of RoHS restricted materials in this product are below the maximum concentration values (also referred to as the threshold limits) permitted for such substances, or are used in an exempted application, in accordance with EU Directive 2011/65/EC (RoHS2), as implemented January 2, 2013. RoHS Declarations for this product can be obtained from your Cree LED representative or from the [Product Ecology](#) section of the Cree LED website.

REACH Compliance

REACH substances of very high concern (SVHCs) information is available for this product. Since the European Chemical Agency (ECHA) has published notice of their intent to frequently revise the SVHC listing for the foreseeable future, please contact a Cree LED representative to insure you get the most up-to-date REACH SVHC Declaration. REACH banned substance information (REACH Article 67) is also available upon request.

NOTES - CONTINUED

UL® Recognized Component

This product meets the requirements to be considered a UL Recognized Component with Level 4 enclosure consideration. The LED package or a portion thereof has been investigated as a fire and electrical enclosure per ANSI/UL 8750.

Vision Advisory

WARNING: Do not look at an exposed lamp in operation. Eye injury can result. For more information about LEDs and eye safety, please refer to the [LED Eye Safety application note](#).

Intellectual Property

For remote phosphor applications, a separate license to certain Cree LED patents is required.

MECHANICAL DIMENSIONS (T_A = 25 °C)

Thermal vias, if present, are not shown on these drawings.

All measurements are ±.13 mm unless otherwise indicated.

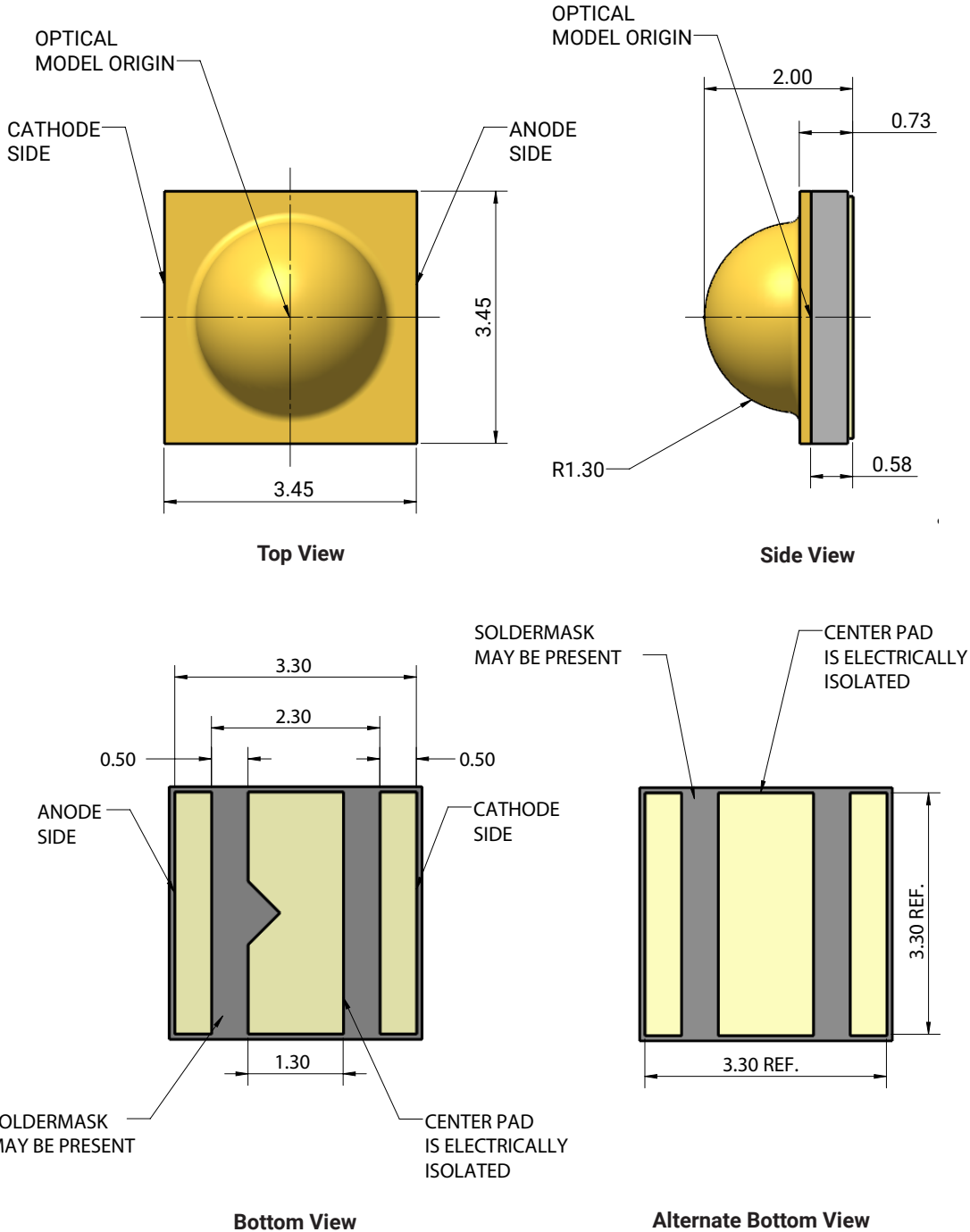

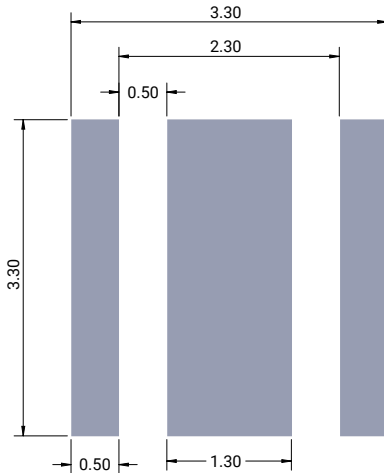
MECHANICAL DIMENSIONS ($T_A = 25\text{ }^\circ\text{C}$) - CONTINUED

Recommended PCB Footprint

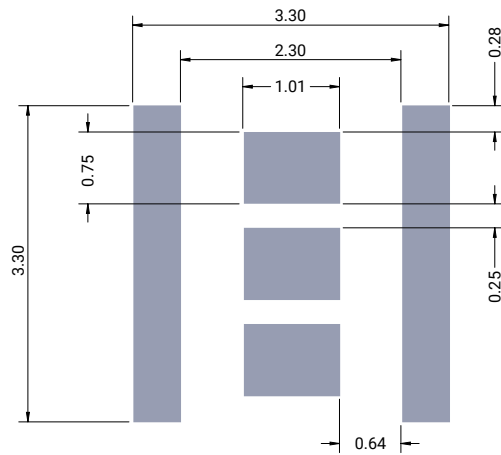

Recommended Stencil Openings*

Notes:

- Cree LED recommends using thermal pad kickouts to maximize component thermal performance.
- Cree LED recommends using white solder mask material to minimize system optical loss.
- * This stencil has been tested and optimized for the avoidance of voiding when using ALPHA® LUMET® P30 Maxrel solder paste. For other solder pastes, a "window pane" design for the thermal pad stencil may result in a lower voiding percentage. Contact your local Cree LED Field Applications Engineer for consultation regarding your specific application.

TAPE AND REEL

All Cree LED carrier tapes conform to EIA-481D, Automated Component Handling Systems Standard.

Except as noted, all dimensions in mm.

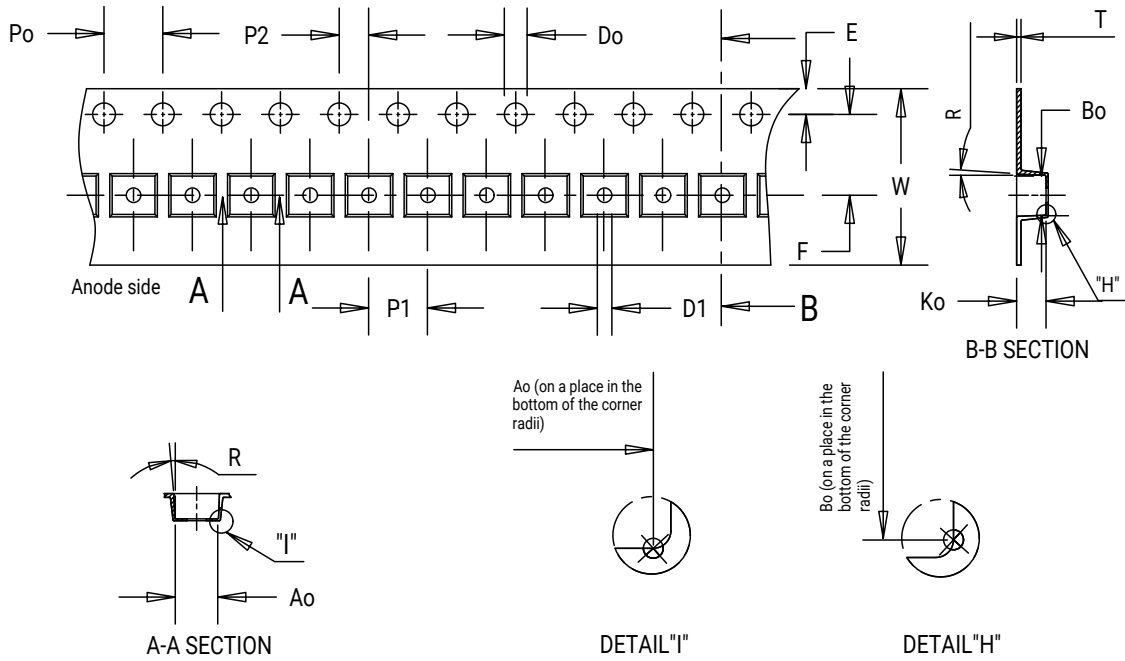

| Item | Ao | Bo | Ko | Po | P1 | P2 | T | E | F | Do | D1 | W | R |
|------|------|------|------|------|------|------|------|------|------|------|------|-------|----|
| Dim. | 3.75 | 3.75 | 2.10 | 4.00 | 8.00 | 2.00 | 0.30 | 1.75 | 5.50 | 1.50 | 1.50 | 12.00 | 8° |

TAPE AND REEL - CONTINUED

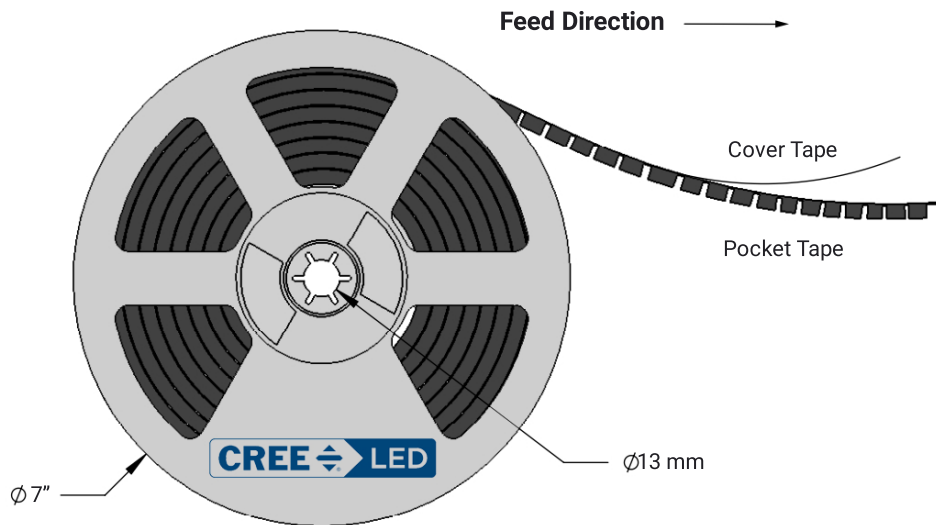
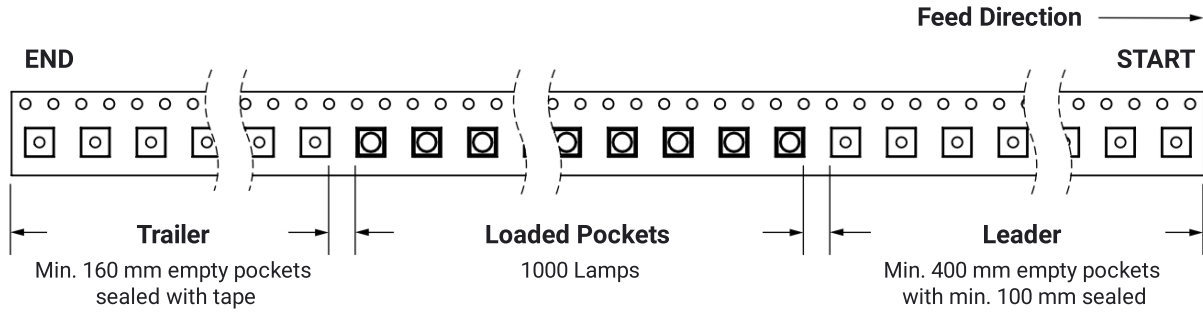

PACKAGING

Unpackaged Reel

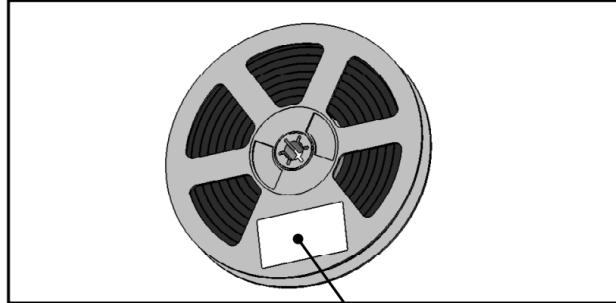

Label with Cree LED Bin Code, Quantity, Reel ID

Packaged Reel

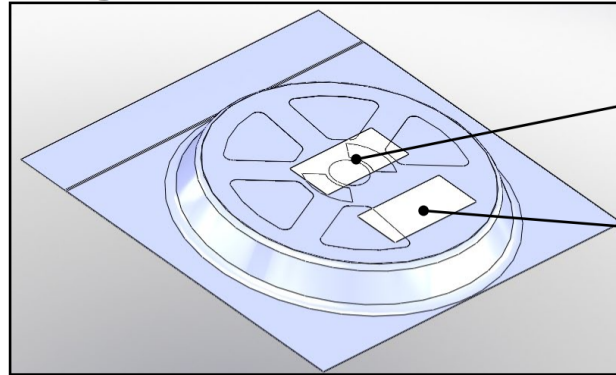

Label with Cree LED Order Code, Quantity, Reel ID, PO#

Label with Cree LED Bin Code, Quantity, Reel ID

Boxed Reel

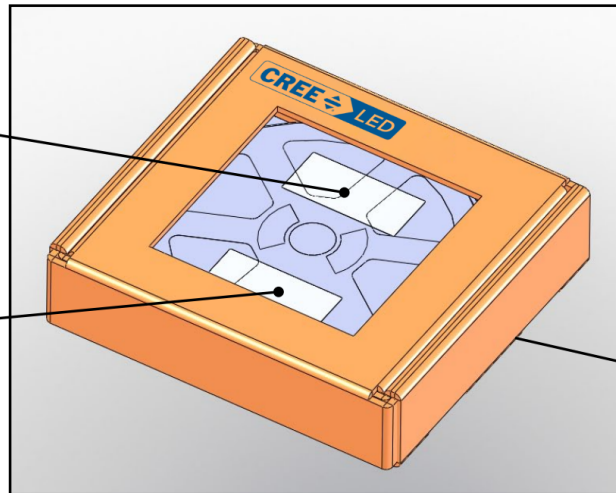

Label with Cree LED Order Code, Quantity, Reel ID, PO#

Label with Cree LED Bin Code, Quantity, Reel ID

Patent Label (on bottom of box)

APPENDIX - ORDER CODES NOT FOR NEW DESIGNS

The following order codes are active and valid order codes, but higher performance options are also available. Please see page 4 - page 8 for order codes of XLamp XP-E white LEDs that could serve as alternatives for the order codes set forth below.

XP-E White, $T_j = 25\text{ }^\circ\text{C}$

| Minimum Luminous Flux (lm) @ 350 mA | | Chromaticity Regions | Order Codes |
|-------------------------------------|-----------|--|----------------------|
| Group | Flux (lm) | | |
| Q4 | 100 | WA, WB, WC, WD, WE, WF, WG, WH, WJ, WK, WM, WN, WP | XPEWHT-L1-0000-00C01 |
| | | WC, WD, WF, WG | XPEWHT-L1-0000-00C02 |
| | | WC, WD, WF, WG, WH, WJ, WN, WP | XPEWHT-L1-0000-00C03 |
| Q5 | 107 | WA, WB, WC, WD, WE, WF, WG, WH, WJ, WK, WM, WN, WP | XPEWHT-L1-0000-00D01 |
| | | WC, WD, WF, WG | XPEWHT-L1-0000-00D02 |
| | | WC, WD, WF, WG, WH, WJ, WN, WP | XPEWHT-L1-0000-00D03 |
| R2 | 114 | WA, WB, WC, WD, WE, WF, WG, WH, WJ, WK, WM, WN, WP | XPEWHT-L1-0000-00E01 |
| | | WC, WD, WF, WG | XPEWHT-L1-0000-00E02 |
| | | WC, WD, WF, WG, WH, WJ, WN, WP | XPEWHT-L1-0000-00E03 |
| R3 | 122 | WA, WB, WC, WD, WE, WF, WG, WH, WJ, WK, WM, WN, WP | XPEWHT-L1-0000-00F01 |
| | | WC, WD, WF, WG | XPEWHT-L1-0000-00F02 |
| | | WC, WD, WF, WG, WH, WJ, WN, WP | XPEWHT-L1-0000-00F03 |

Notes:

- Cree LED maintains a tolerance of $\pm 7\%$ on flux and power measurements, ± 0.005 on chromaticity (CCx, CCy) measurements and a tolerance of ± 2 on CRI measurements. See the Measurements section (page 34).
- XLamp XP-E LED order codes specify only a minimum flux bin and not a maximum. Cree LED may ship reels in flux bins higher than the minimum specified by the order code without advance notice. Shipments will always adhere to the chromaticity bin restrictions specified by the order code.

APPENDIX - ORDER CODES NOT FOR NEW DESIGNS - CONTINUED

| Chromaticity | | Minimum Luminous Flux (lm) @ 350 mA | | Order Codes |
|--------------|--------|-------------------------------------|-----------|----------------------|
| Kit | CCT | Code | Flux (lm) | 70 CRI Typical |
| 51 | 6200 K | R3 | 122 | XPEWHT-L1-0000-00F51 |
| | | R2 | 114 | XPEWHT-L1-0000-00E51 |
| | | Q5 | 107 | XPEWHT-L1-0000-00D51 |
| | | Q4 | 100 | XPEWHT-L1-0000-00C51 |
| 53 | 6000 K | R3 | 122 | XPEWHT-L1-0000-00F53 |
| | | R2 | 114 | XPEWHT-L1-0000-00E53 |
| | | Q5 | 107 | XPEWHT-L1-0000-00D53 |
| | | Q4 | 100 | XPEWHT-L1-0000-00C53 |
| 50 | 6200 K | R3 | 122 | XPEWHT-L1-0000-00F50 |
| | | R2 | 114 | XPEWHT-L1-0000-00E50 |
| | | Q5 | 107 | XPEWHT-L1-0000-00D50 |
| | | Q4 | 100 | XPEWHT-L1-0000-00C50 |
| E1 | 6500 K | R3 | 122 | XPEWHT-L1-0000-00FE1 |
| | | R2 | 114 | XPEWHT-L1-0000-00EE1 |
| | | Q5 | 107 | XPEWHT-L1-0000-00DE1 |
| | | Q4 | 100 | XPEWHT-L1-0000-00CE1 |
| E2 | 5700 K | R3 | 122 | XPEWHT-L1-0000-00FE2 |
| | | R2 | 114 | XPEWHT-L1-0000-00EE2 |
| | | Q5 | 107 | XPEWHT-L1-0000-00DE2 |
| | | Q4 | 100 | XPEWHT-L1-0000-00CE2 |

Notes:

- Cree LED maintains a tolerance of $\pm 7\%$ on flux and power measurements, ± 0.005 on chromaticity (CCx, CCy) measurements and a tolerance of ± 2 on CRI measurements. See the Measurements section (page 34).
- XLamp XP-E LED order codes specify only a minimum flux bin and not a maximum. Cree LED may ship reels in flux bins higher than the minimum specified by the order code without advance notice. Shipments will always adhere to the chromaticity bin restrictions specified by the order code.

APPENDIX - ORDER CODES NOT FOR NEW DESIGNS - CONTINUED

| Chromaticity | | Minimum Luminous Flux (lm) @ 350 mA | | Order Codes | |
|--------------|--------|-------------------------------------|-----------|----------------------|----------------------|
| Kit | CCT | Code | Flux (lm) | 75 CRI Typical | 80 CRI Minimum |
| E3 | 5000 K | Q5 | 107 | XPEWHT-L1-0000-00DE3 | |
| | | Q4 | 100 | XPEWHT-L1-0000-00CE3 | |
| | | Q3 | 93.9 | XPEWHT-L1-0000-00BE3 | |
| F4 | 4750 K | Q5 | 107 | XPEWHT-L1-0000-00DF4 | |
| | | Q4 | 100 | XPEWHT-L1-0000-00CF4 | |
| | | Q3 | 93.9 | XPEWHT-L1-0000-00BF4 | |
| E4 | 4500 K | Q5 | 107 | XPEWHT-L1-0000-00DE4 | |
| | | Q4 | 100 | XPEWHT-L1-0000-00CE4 | |
| | | Q3 | 93.9 | XPEWHT-L1-0000-00BE4 | |
| F5 | 4250 K | Q5 | 107 | XPEWHT-L1-0000-00DF5 | |
| | | Q4 | 100 | XPEWHT-L1-0000-00CF5 | |
| | | Q3 | 93.9 | XPEWHT-L1-0000-00BF5 | |
| | | Q2 | 87.4 | XPEWHT-L1-0000-00AF5 | |
| E5 | 4000 K | Q5 | 107 | XPEWHT-L1-0000-00DE5 | |
| | | Q4 | 100 | XPEWHT-L1-0000-00CE5 | XPEWHT-H1-0000-00CE5 |
| | | Q3 | 93.9 | XPEWHT-L1-0000-00BE5 | XPEWHT-H1-0000-00BE5 |
| | | Q2 | 87.4 | XPEWHT-L1-0000-00AE5 | XPEWHT-H1-0000-00AE5 |
| Z5 | 4000 K | Q4 | 100 | XPEWHT-L1-0000-00CZ5 | |
| | | Q3 | 93.9 | XPEWHT-L1-0000-00BZ5 | XPEWHT-H1-0000-00BZ5 |
| | | Q2 | 87.4 | XPEWHT-L1-0000-00AZ5 | XPEWHT-H1-0000-00AZ5 |

Notes:

- Cree LED maintains a tolerance of ±7% on flux and power measurements, ±0.005 on chromaticity (CCx, CCy) measurements and a tolerance of ±2 on CRI measurements. See the Measurements section (page 34).
- XLamp XP-E LED order codes specify only a minimum flux bin and not a maximum. Cree LED may ship reels in flux bins higher than the minimum specified by the order code without advance notice. Shipments will always adhere to the chromaticity bin restrictions specified by the order code.

APPENDIX - ORDER CODES NOT FOR NEW DESIGNS - CONTINUED

| Chromaticity | | Minimum Luminous Flux (lm) @ 350 mA | | Order Codes | | | |
|--------------|--------|-------------------------------------|-----------|----------------------|----------------------|----------------------|----------------------|
| Kit | CCT | Code | Flux (lm) | 80 CRI Typical | 80 CRI Minimum | 85 CRI Minimum | 90 CRI Minimum |
| F6 | 3750 K | Q4 | 100 | XPEWHT-L1-0000-00CF6 | | | |
| | | Q3 | 93.9 | XPEWHT-L1-0000-00BF6 | XPEWHT-H1-0000-00BF6 | | |
| | | Q2 | 87.4 | XPEWHT-L1-0000-00AF6 | XPEWHT-H1-0000-00AF6 | | |
| | | P4 | 80.6 | XPEWHT-L1-0000-009F6 | XPEWHT-H1-0000-009F6 | | |
| E6 | 3500 K | Q4 | 100 | XPEWHT-L1-0000-00CE6 | | | |
| | | Q3 | 93.9 | XPEWHT-L1-0000-00BE6 | XPEWHT-H1-0000-00BE6 | | |
| | | Q2 | 87.4 | XPEWHT-L1-0000-00AE6 | XPEWHT-H1-0000-00AE6 | | |
| | | P4 | 80.6 | XPEWHT-L1-0000-009E6 | XPEWHT-H1-0000-009E6 | | |
| Z6 | 3500 K | Q3 | 93.9 | XPEWHT-L1-0000-00BZ6 | | | |
| | | Q2 | 87.4 | XPEWHT-L1-0000-00AZ6 | XPEWHT-H1-0000-00AZ6 | | |
| | | P4 | 80.6 | XPEWHT-L1-0000-009Z6 | XPEWHT-H1-0000-009Z6 | | |
| F7 | 3250 K | Q3 | 93.9 | XPEWHT-L1-0000-00BF7 | | | |
| | | Q2 | 87.4 | XPEWHT-L1-0000-00AF7 | XPEWHT-H1-0000-00AF7 | | |
| | | P4 | 80.6 | XPEWHT-L1-0000-009F7 | XPEWHT-H1-0000-009F7 | | |
| E7 | 3000 K | Q3 | 93.9 | XPEWHT-L1-0000-00BE7 | | | |
| | | Q2 | 87.4 | XPEWHT-L1-0000-00AE7 | XPEWHT-H1-0000-00AE7 | | |
| | | P4 | 80.6 | XPEWHT-L1-0000-009E7 | XPEWHT-H1-0000-009E7 | XPEWHT-P1-0000-009E7 | |
| | | P3 | 73.9 | | | XPEWHT-P1-0000-008E7 | XPEWHT-U1-0000-008E7 |
| | | P2 | 67.2 | | | XPEWHT-P1-0000-007E7 | XPEWHT-U1-0000-007E7 |
| | | N4 | 62 | | | XPEWHT-P1-0000-006E7 | XPEWHT-U1-0000-006E7 |
| Z7 | 3000 K | Q2 | 87.4 | XPEWHT-L1-0000-00AZ7 | XPEWHT-H1-0000-00AZ7 | | |
| | | P4 | 80.6 | XPEWHT-L1-0000-009Z7 | XPEWHT-H1-0000-009Z7 | | |
| | | P3 | 73.9 | | | XPEWHT-P1-0000-008Z7 | |
| | | P2 | 67.2 | | | XPEWHT-P1-0000-007Z7 | XPEWHT-U1-0000-007Z7 |
| | | N4 | 62 | | | XPEWHT-P1-0000-006Z7 | XPEWHT-U1-0000-006Z7 |
| F8 | 2850 K | Q2 | 87.4 | XPEWHT-L1-0000-00AF8 | | | |
| | | P4 | 80.6 | XPEWHT-L1-0000-009F8 | XPEWHT-H1-0000-009F8 | | |
| | | P3 | 73.9 | XPEWHT-L1-0000-008F8 | XPEWHT-H1-0000-008F8 | XPEWHT-P1-0000-008F8 | |
| | | P2 | 67.2 | | | XPEWHT-P1-0000-007F8 | XPEWHT-U1-0000-007F8 |
| | | N4 | 62 | | | XPEWHT-P1-0000-006F8 | XPEWHT-U1-0000-006F8 |
| | | N3 | 56.8 | | | XPEWHT-P1-0000-005F8 | XPEWHT-U1-0000-005F8 |
| E8 | 2700 K | Q2 | 87.4 | XPEWHT-L1-0000-00AE8 | | | |
| | | P4 | 80.6 | XPEWHT-L1-0000-009E8 | XPEWHT-H1-0000-009E8 | | |
| | | P3 | 73.9 | XPEWHT-L1-0000-008E8 | XPEWHT-H1-0000-008E8 | XPEWHT-P1-0000-008E8 | |
| | | P2 | 67.2 | | | XPEWHT-P1-0000-007E8 | XPEWHT-U1-0000-007E8 |
| | | N4 | 62 | | | XPEWHT-P1-0000-006E8 | XPEWHT-U1-0000-006E8 |
| | | N3 | 56.8 | | | XPEWHT-P1-0000-005E8 | XPEWHT-U1-0000-005E8 |

Notes:

- Cree LED maintains a tolerance of ±7% on flux and power measurements, ±0.005 on chromaticity (CCx, CCy) measurements and a tolerance of ±2 on CRI measurements. See the Measurements section (page 34).
- XLamp XP-E LED order codes specify only a minimum flux bin and not a maximum. Cree LED may ship reels in flux bins higher than the minimum specified by the order code without advance notice. Shipments will always adhere to the chromaticity bin restrictions specified by the order code.

APPENDIX - ORDER CODES NOT FOR NEW DESIGNS - CONTINUED

| Chromaticity | | Minimum Luminous Flux (lm) @ 350 mA | | Order Codes | | | |
|--------------|--------|-------------------------------------|-----------|----------------------|----------------------|----------------------|----------------------|
| Kit | CCT | Code | Flux (lm) | 80 CRI Typical | 80 CRI Minimum | 85 CRI Minimum | 90 CRI Minimum |
| Z8 | 2700 K | P4 | 80.6 | XPEWHT-L1-0000-009Z8 | XPEWHT-H1-0000-009Z8 | | |
| | | P3 | 73.9 | XPEWHT-L1-0000-008Z8 | XPEWHT-H1-0000-008Z8 | | |
| | | P2 | 67.2 | | | XPEWHT-P1-0000-007Z8 | |
| | | N4 | 62 | | | XPEWHT-P1-0000-006Z8 | XPEWHT-U1-0000-006Z8 |
| | | N3 | 56.8 | | | XPEWHT-P1-0000-005Z8 | XPEWHT-U1-0000-005Z8 |

Notes:

- Cree LED maintains a tolerance of $\pm 7\%$ on flux and power measurements, ± 0.005 on chromaticity (CCx, CCy) measurements and a tolerance of ± 2 on CRI measurements. See the Measurements section (page 34).
- XLamp XP-E LED order codes specify only a minimum flux bin and not a maximum. Cree LED may ship reels in flux bins higher than the minimum specified by the order code without advance notice. Shipments will always adhere to the chromaticity bin restrictions specified by the order code.

APPENDIX - ORDER CODES NOT FOR NEW DESIGNS - CONTINUED

The following order codes are active and valid order codes, but higher performance options are also available. Please see page 9 - page 10 for order codes of XLamp XP-E color LEDs that could serve as alternatives for the order codes set forth below.

| Color | Minimum Luminous Flux (lm)@ 350 mA | | Dominant Wavelength (nm) | | | | Order Codes |
|-------|------------------------------------|-----------|--------------------------|----------|---------|----------|----------------------|
| | | | Minimum | | Maximum | | |
| | Group | Flux (lm) | Group | DWL (nm) | Group | DWL (nm) | |
| Blue | K2 | 30.6 | B4 | 470 | B5 | 480 | XPEBLU-L1-0000-00Y05 |
| | K3 | 35.2 | B4 | 470 | B5 | 480 | XPEBLU-L1-0000-00Z05 |

| Color | Minimum Luminous Flux (lm)@ 350 mA | | Calculated Minimum PPF (μmol/s) | Dominant Wavelength (nm) | | | | Order Codes |
|-------|------------------------------------|-----------|---------------------------------|--------------------------|----------|---------|----------|----------------------|
| | | | | Minimum | | Maximum | | |
| | Group | Flux (lm) | | Group | DWL (nm) | Group | DWL (nm) | |
| Green | P4 | 80.6 | 0.74 | G2 | 520 | G4 | 535 | XPEGRN-L1-0000-00901 |
| | | | | G2 | 520 | G3 | 530 | XPEGRN-L1-0000-00902 |
| | | | | G3 | 525 | G4 | 535 | XPEGRN-L1-0000-00903 |
| | Q2 | 87.4 | 0.80 | G2 | 520 | G4 | 535 | XPEGRN-L1-0000-00A01 |
| | | | | G2 | 520 | G3 | 530 | XPEGRN-L1-0000-00A02 |
| | | | | G3 | 525 | G4 | 535 | XPEGRN-L1-0000-00A03 |
| | Q3 | 93.9 | 0.86 | G2 | 520 | G4 | 535 | XPEGRN-L1-0000-00B01 |
| | | | | G2 | 520 | G3 | 530 | XPEGRN-L1-0000-00B02 |
| | | | | G3 | 525 | G4 | 535 | XPEGRN-L1-0000-00B03 |
| | Q4 | 100 | 0.91 | G2 | 520 | G4 | 535 | XPEGRN-L1-0000-00C01 |
| | | | | G2 | 520 | G3 | 530 | XPEGRN-L1-0000-00C02 |
| | | | | G3 | 525 | G4 | 535 | XPEGRN-L1-0000-00C03 |
| | Q5 | 107 | 0.98 | G2 | 520 | G4 | 535 | XPEGRN-L1-0000-00D01 |
| | | | | G2 | 520 | G3 | 530 | XPEGRN-L1-0000-00D02 |
| | | | | G3 | 525 | G4 | 535 | XPEGRN-L1-0000-00D03 |
| | R2 | 114 | 1.04 | G2 | 520 | G4 | 535 | XPEGRN-L1-0000-00E01 |
| | | | | G2 | 520 | G3 | 530 | XPEGRN-L1-0000-00E02 |
| | | | | G3 | 525 | G4 | 535 | XPEGRN-L1-0000-00E03 |
| | R3 | 122 | 1.11 | G2 | 520 | G4 | 535 | XPEGRN-L1-0000-00F01 |
| | | | | G2 | 520 | G3 | 530 | XPEGRN-L1-0000-00F02 |

Notes:

- Cree LED maintains a tolerance of ±7% on flux and power measurements, ±0.005 on chromaticity (CCx, CCy) measurements and a tolerance of ±2 on CRI measurements. See the Measurements section (page 34).
- XLamp XP-E LED order codes specify only a minimum flux bin and not a maximum. Cree LED may ship reels in flux bins higher than the minimum specified by the order code without advance notice. Shipments will always adhere to the chromaticity bin restrictions specified by the order code.