

## 500mA, Low-Noise LDO Voltage Regulator

### FEATURES

- Low Noise: 40 $\mu$ V Possible
- High Accuracy: 1%
- Reverse Battery Protection
- Low Dropout: 340mV at Full Load
- Low Quiescent Current: 90 $\mu$ A
- Zero Off-Mode Current
- Fixed Output: 1.2V, 1.5V, 1.8V, 2.5V, 3.0V, 3.1V, 3.3V, 5.0V. Adj. Output also available.
- Available in RoHS Compliant, Lead Free Packages: 5 Pin SOT-23, 8 Pin Narrow SOIC and 8 pin 2X3 DFN

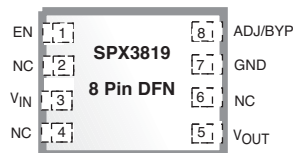

### APPLICATIONS

- Battery Powered Systems
- Cordless Phones
- Radio Control Systems
- Portable/Palm Top/Notebook Computers
- Portable Consumer Equipment
- Portable Instrumentation
- Bar Code Scanners
- SMPS Post Regulators

### DESCRIPTION

The SPX3819 is a positive voltage regulator with a low dropout voltage and low noise output. In addition, this device offers a very low ground current of 800 $\mu$ A at 100mA output. The SPX3819 has an initial tolerance of less than 1% max and a logic compatible ON/OFF switched input. When disabled, power consumption drops to nearly zero. Other key features include reverse battery protection, current limit, and thermal shutdown. The SPX3819 includes a reference bypass pin for optimal low noise output performance. With its very low output temperature coefficient, this device also makes a superior low power voltage reference.

The SPX3819 is an excellent choice for use in battery-powered applications such as cordless telephones, radio control systems, and portable computers. It is available in several fixed voltages -- 1.2V, 1.5V, 1.8V, 2.5V, 3.0V, 3.1V, 3.3V, 5.0V -- or with an adjustable output. This device is offered in 8 pin NSOIC, 8 pin DFN and 5-pin SOT-23 packages.

### TYPICAL APPLICATION CIRCUIT

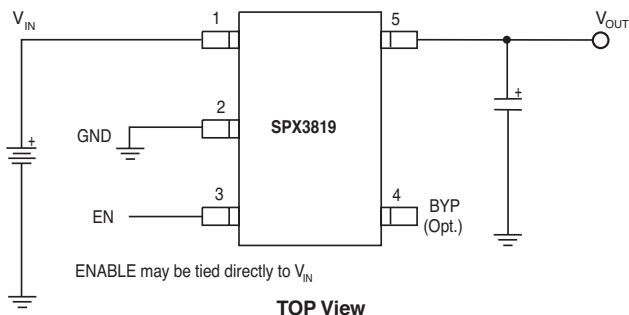

## ABSOLUTE MAXIMUM RATINGS

Power Dissipation .....	Internally Limited
Lead Temp. (Soldering, 5 Seconds) .....	260°C
Operating Junction Temperature Range .....	-40°C to +125°C
Input Supply Voltage .....	-20V to +20V
Enable Input Voltage .....	-20V to +20V

## RECOMMENDED OPERATING CONDITIONS

Input Voltage .....	+2.5V to +16V
Operating Junction Temperature Range .....	-40°C to +125°C
Enable Input Voltage .....	0.0V to $V_{IN}$

## ELECTRICAL CHARACTERISTICS

$T_J=25^\circ\text{C}$ ,  $V_{OUT} + 1\text{V}$ , for 1.2V Option  $V_{IN}=V_{OUT} + 1.2\text{V}$   $I_L=100\mu\text{A}$ ,  $C_L=1\mu\text{F}$ , and  $V_{ENABLE} \geq 2.4\text{V}$ . The ♦ denotes the specifications which apply over full operating temperature range  $-40^\circ\text{C}$  to  $+85^\circ\text{C}$ , unless otherwise specified.

PARAMETER	MIN	TYP	MAX	UNITS	♦	CONDITIONS
Output Voltage Tolerance	-1 -2		+1 +2	%	♦	
Output Voltage Temperature Coef.		57		ppm/°C		
Line Regulation		0.04	0.1	%/V		$V_{IN}=V_{OUT} + 1\text{V}$ to 16V
Load Regulation		0.05	0.4	%		$I_L = 0.1\text{mA}$ to 500mA
Dropout Voltage ( $V_{IN}-V_O$ )(Note 2)		10	60 80	mV	♦	$I_L = 100\mu\text{A}$
		125	175 250	mV	♦	$I_L = 50\text{mA}$
		180	350 450	mV	♦	$I_L = 150\text{mA}$
		340	550 700	mV	♦	$I_L = 500\text{mA}$
Quiescent Current ( $I_{GND}$ )		0.05	3 8	$\mu\text{A}$	♦	$V_{ENABLE} \leq 0.4\text{V}$ $V_{ENABLE} \leq 0.25\text{V}$
Ground Pin Current ( $I_{GND}$ )		90	150 190	$\mu\text{A}$	♦	$I_L = 100\mu\text{A}$
		250	650 900	$\mu\text{A}$	♦	$I_L = 50\text{mA}$
		1.0	2.0 2.5	mA	♦	$I_L = 150\text{mA}$
		6.5	25.0 30.0	mA	♦	$I_L = 500\text{mA}$
Ripple Rejection (PSRR)		70		dB		
Current Limit ( $I_{LIMIT}$ )		800	950	mA	♦	$V_{OUT} = 0.0\text{V}$
Output Noise ( $e_{NO}$ )		300		$\mu\text{V}_{RMS}$		$I_L=10\text{mA}$ , $C_L=1.0\mu\text{F}$ , $C_{IN}=1\mu\text{F}$ , (10Hz-100kHz)
		40		$\mu\text{V}_{RMS}$		$I_L=10\text{mA}$ , $C_L=10\mu\text{F}$ , $C_{BYP}=1\mu\text{F}$ , $C_{IN}=1\mu\text{F}$ , (10Hz-100kHz)
Input Voltage Level Logic Low ( $V_{IL}$ )			0.4	V		OFF
Input Voltage Level Logic High ( $V_{IH}$ )	2			V		ON
ENABLE Input Current		0.01 3	2 20	$\mu\text{A}$		$V_{IL} \leq 0.4\text{V}$ $V_{IH} \geq 2.0\text{V}$
Thermal Resistance (Note 1)		191		°C/W	♦	SOT-23-5 / Junction to Ambient
		128.4		°C/W	♦	NSOIC-8 / Junction to Ambient
		59		°C/W	♦	DFN-8 / Junction to Ambient

### NOTES

**Note 1:** The maximum allowable power dissipation is a function of maximum operating junction temperature,  $T_{J(max)}$  the junction to ambient thermal resistance, and the ambient  $\theta_{JA}$ , and the ambient temperature  $T_A$ . The maximum allowable power dissipation at any ambient temperature is given:  $P_{D(max)} = (T_{J(max)} - T_A) / \theta_{JA}$ , exceeding the maximum allowable power limit will result in excessive die temperature; thus, the regulator will go into thermal shutdown. The  $\theta_{JA}$  of the SPX3819 is 220°C/W mounted on a PC board.

**Note 2:** Not applicable to output voltage 2V or less.

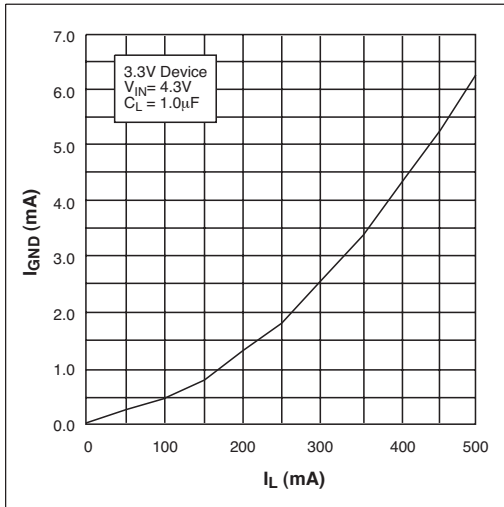

Ground Current vs Load Current

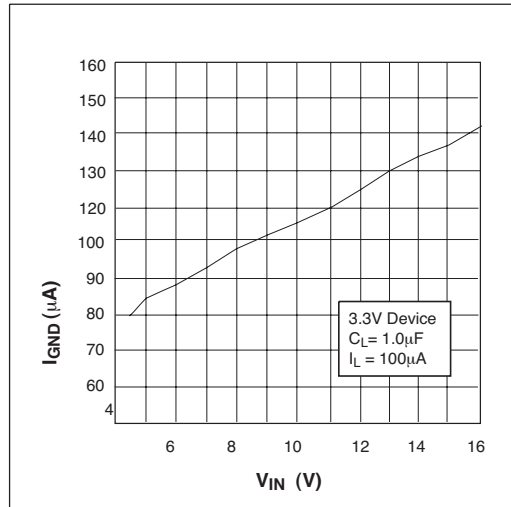

Ground Current vs Input Voltage

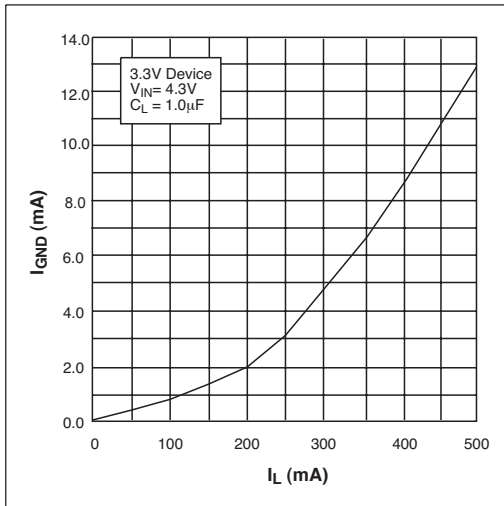

Ground Current vs Load Current in Dropout

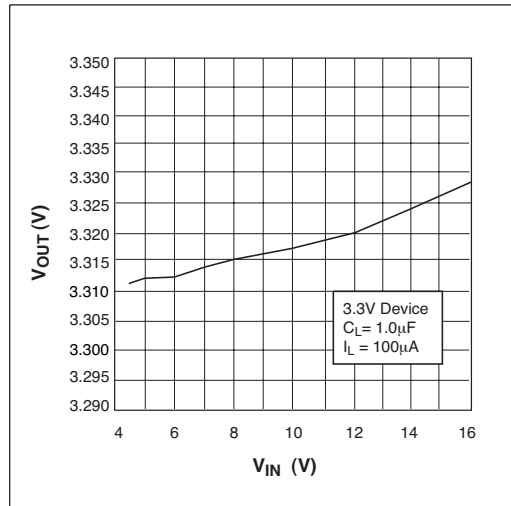

Output Voltage vs Input Voltage

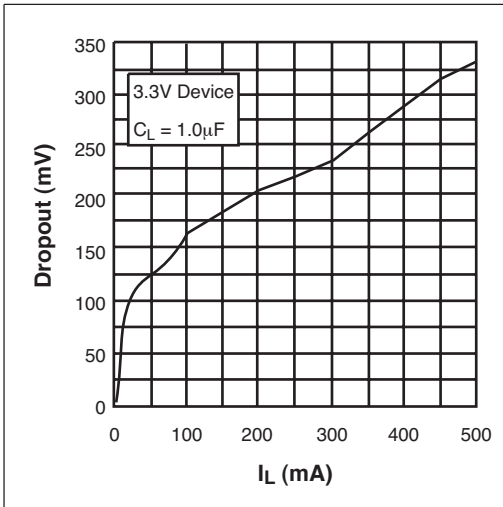

Dropout Voltage vs Load Current

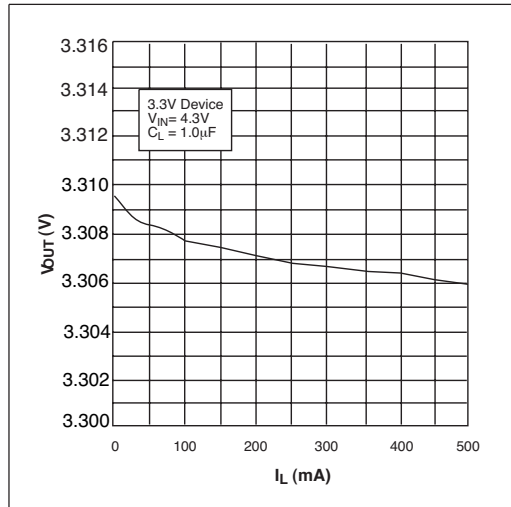

Output Voltage vs Load Current

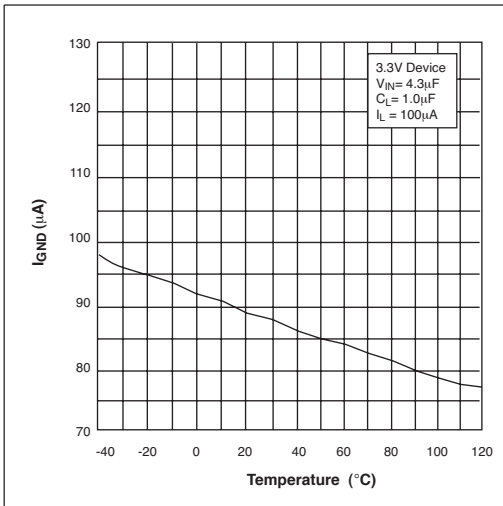

Ground Current vs Temperature with 100µA Load

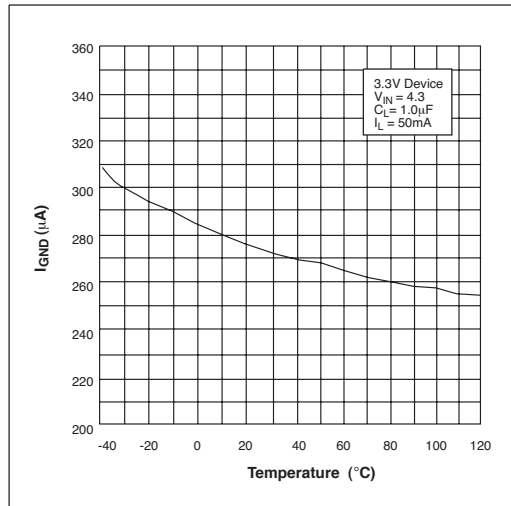

Ground Current vs Temperature with 50mA Load

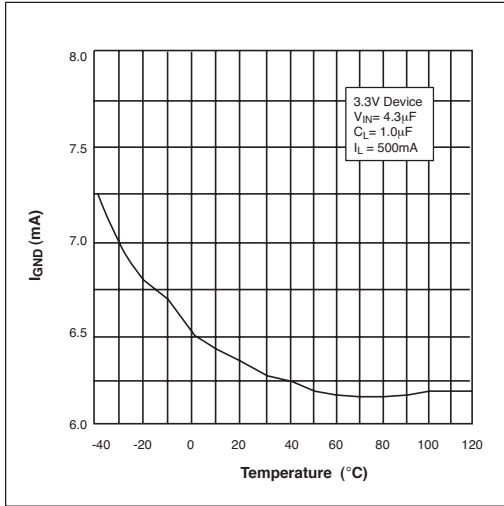

Ground Current vs Temperature with 500mA Load

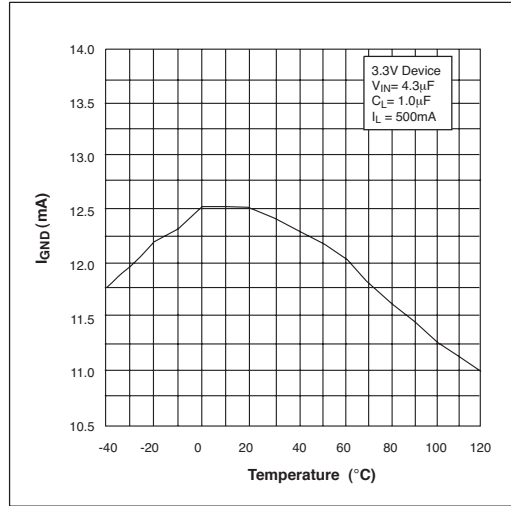

Ground Current vs Temperature in Dropout

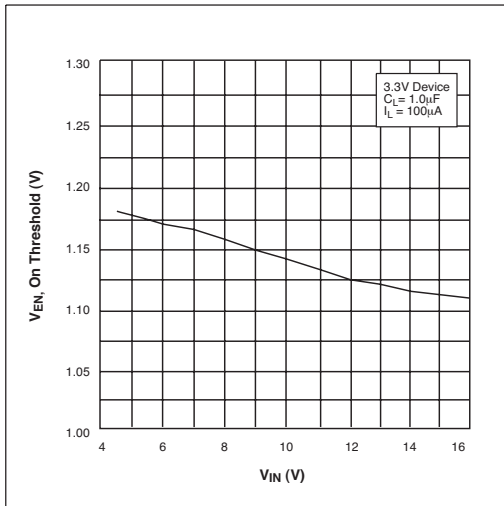

ENABLE Voltage, ON threshold, vs Input Voltage

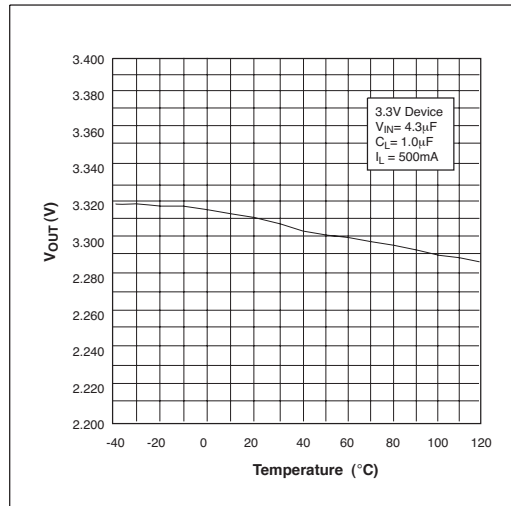

Output Voltage vs Temperature

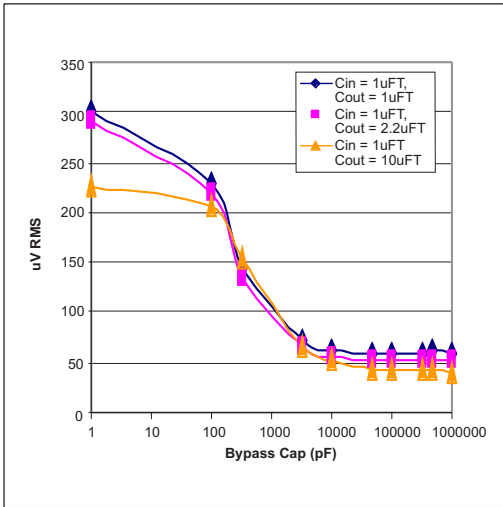

Output Noise vs Bypass Capacitor Value  $I_L = 10mA$ , 10Hz - 100kHz

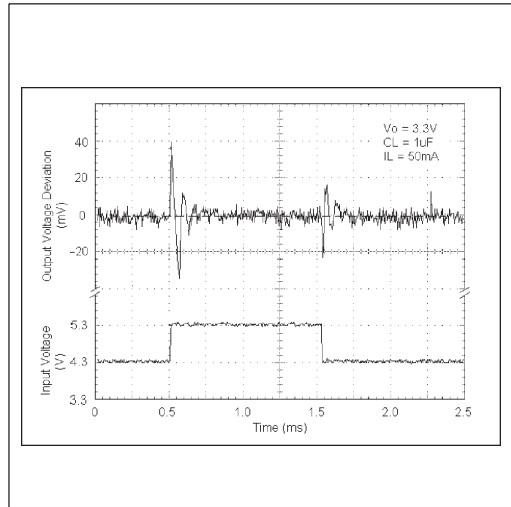

Line Transient Response for 3.3V Device

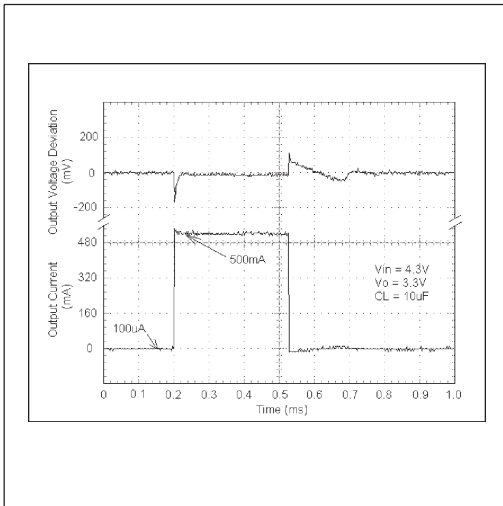

Load Transient Response for 3.3V Device

The SPX3819 requires an output capacitor for device stability. Its value depends upon the application circuit. In general, linear regulator stability decreases with higher output currents. In applications where the SPX3819 is sourcing less current, a lower output capacitance may be sufficient. For example, a regulator outputting only 10mA, requires approximately half the capacitance as the same regulator sourcing 150mA.

Bench testing is the best method for determining the proper type and value of the capacitor since the high frequency characteristics of electrolytic capacitors vary widely, depending on type and manufacturer. A high quality 2.2 $\mu$ F aluminum electrolytic capacitor works in most application circuits, but the same stability often can be obtained with a 1 $\mu$ F tantalum electrolytic.

With the SPX3819 adjustable version, the minimum value of output capacitance is a function of the output voltage. The value decreases with higher output voltages, since closed loop gain is increased.

### Typical Applications Circuits

A 10nF capacitor on the BYP pin will significantly reduce output noise, but it may be left unconnected if the output noise is not a major

concern. The SPX3819 start-up speed is inversely proportional to the size of the BYP capacitor. Applications requiring a slow ramp-up of the output voltage should use a larger  $C_{BYP}$ . However, if a rapid turn-on is necessary, the BYP capacitor can be omitted.

The SPX3819's internal reference is available through the BYP pin.

*Figure 1* represents a SPX3819 standard application circuit. The EN (enable) pin is pulled high (>2.0V) to enable the regulator.

To disable the regulator, EN < 0.4V.

The SPX3819 in *Figure 2* illustrates a typical adjustable output voltage configuration. Two resistors ( $R_1$  and  $R_2$ ) set the output voltage. The output voltage is calculated using the formula:

$$V_{OUT} = 1.235V \times \left[ 1 + R_1/R_2 \right]$$

$R_2$  must be > 10 k $\Omega$  and for best results,  $R_2$  should be between 22 k $\Omega$  and 47k $\Omega$ .

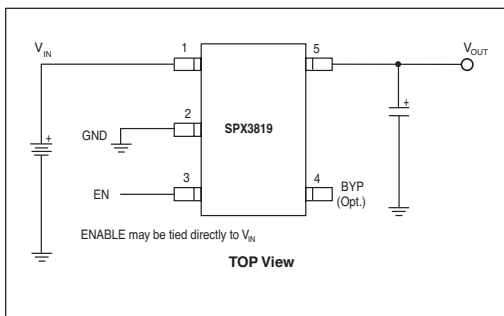

*Figure 1. Standard Application Circuit*

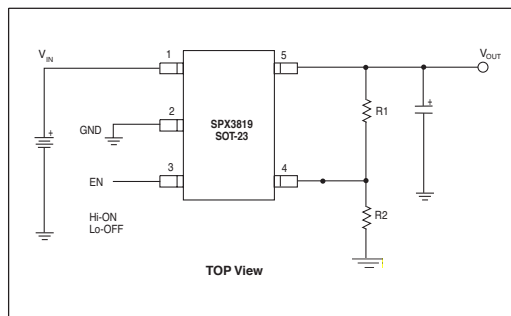

*Figure 2. Typical Adjustable Output Voltage Configuration*

Pin # nSOIC	Pin # DFN	Pin # SOT-3	Pin Name	Description
2	3	1	V <sub>IN</sub>	Supply Input
5-8	7	2	GND	Ground
3	5	5	V <sub>OUT</sub>	Regulator Output
1	1	3	EN	Enable(input). CMOS compatible control input. Logic high = enable; logic low or open = shutdown
4	8	4	ADJ/BYP	Adjust(input). Feedback input. Connect to resistive voltage-divider network
-	4, 6	-	NC	No Connect

**PACKAGE: PINOUTS**

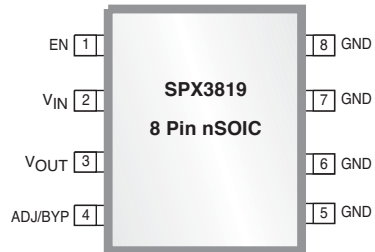
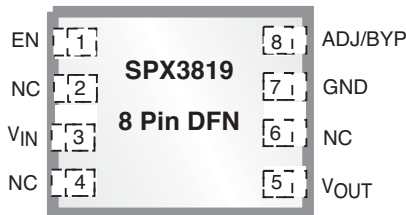

Note: The bottom exposed pad for the SPX3819 DFN package is connected to GND.

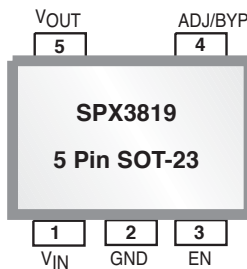





## Appendix and Web Link Information

For further assistance:

Email: [Sipexsupport@sipex.com](mailto:Sipexsupport@sipex.com)  
WWW Support page: <http://www.sipex.com/content.aspx?p=support>  
Sipex Application Notes: <http://www.sipex.com/applicationNotes.aspx>  
Product Change Notices: <http://www.sipex.com/content.aspx?p=pcn>



### Sipex Corporation

Headquarters and  
Sales Office  
233 South Hillview Drive  
Milpitas, CA95035  
tel: (408) 934-7500  
faX: (408) 935-7600

Sipex Corporation reserves the right to make changes to any products described herein. Sipex does not assume any liability arising out of the application or use of any product or circuit described herein; neither does it convey any license under its patent rights nor the rights of others.

**The following sections contain information which is more changeable in nature and is therefore generated as appendices.**

- 1) Package Outline Drawings**
- 2) Ordering Information**

**If Available:**

- 3) Frequently Asked Questions**
- 4) Evaluation Board Manuals**
- 5) Reliability Reports**
- 6) Product Characterization Reports**
- 7) Application Notes for this product**
- 8) Design Solutions for this product**

REVISION HISTORY				
REV.	DISCRIPTION	DATE	APP'D	
A	DRAWING ORIGINATION	08/16/05	JL	
B	DRAWING FORMAT MODIFICATION	07/19/06	JL	

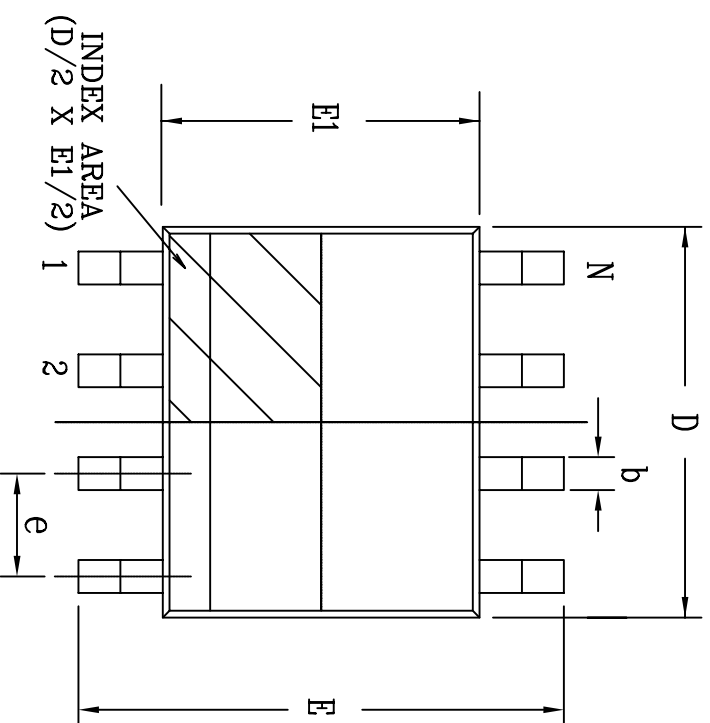

Top View

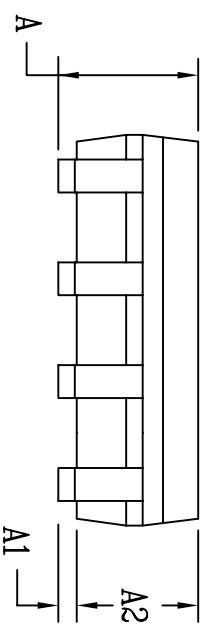

Side View

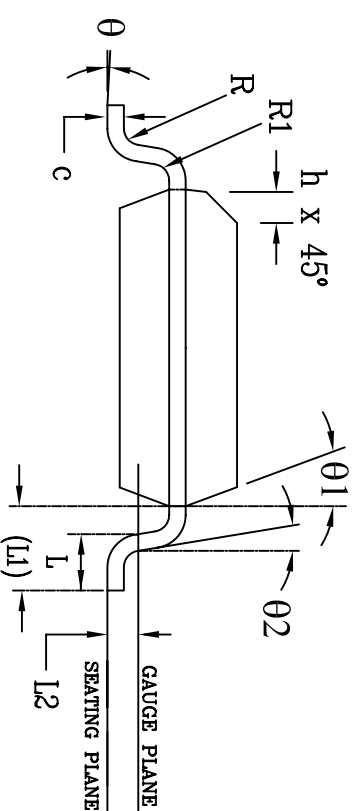

Front View

8 Pin SOICN		JEDEC MS-012		Variation AA		
SYMBOLS	DIMENSIONS IN MM (Control Unit)			DIMENSIONS IN INCH (Reference Unit)		
	MIN	NOM	MAX	MIN	NOM	MAX
A	1.35	—	1.75	0.053	—	0.069
A1	0.10	—	0.25	0.004	—	0.010
A2	1.25	—	1.65	0.049	—	0.065
b	0.31	—	0.51	0.012	—	0.020
c	0.17	—	0.25	0.007	—	0.010
E	6.00 BSC			0.236 BSC		
E1	3.90 BSC			0.154 BSC		
e	1.27 BSC			0.050 BSC		
h	0.25	—	0.50	0.010	—	0.020
L	0.40	—	1.27	0.016	—	0.050
L1	1.04 REF			0.041 REF		
L2	0.25 BSC			0.010 BSC		
R	0.07	—	—	0.003	—	—
R1	0.07	—	—	0.003	—	—
theta	0°	—	8°	0°	—	8°
theta1	5°	—	15°	5°	—	15°
theta2	0°	—	—	0°	—	—
D	4.90 BSC			0.193 BSC		
N	8			8		

		<b>SIPEX CORPORATION</b>	
Packaging Approval:		Drawing No: 8-PIN SOICN	
By: JL	Date: 07/19/06	Revision: B	Sheet: 1 OF 1

REVISION HISTORY			
REV.	DESCRIPTION	DATE	APP'D
A	DRAWING ORIGINATION	08/18/05	JL
B	MODIFY DRAWING FORMAT	07/17/06	JL

TOP VIEW

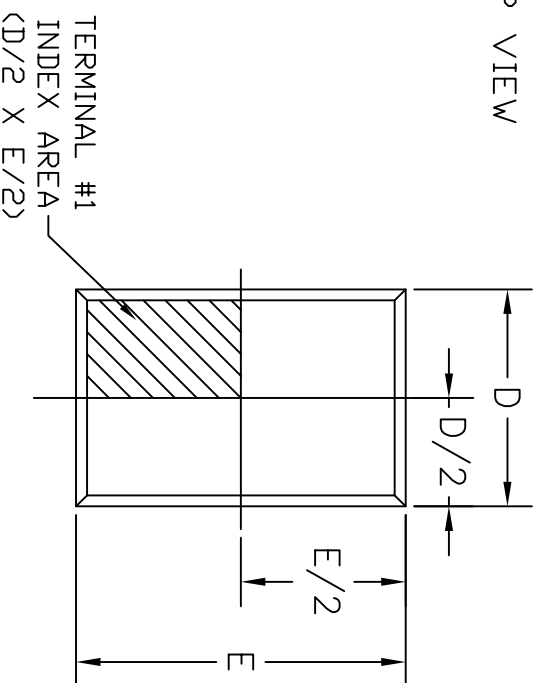

BOTTOM VIEW

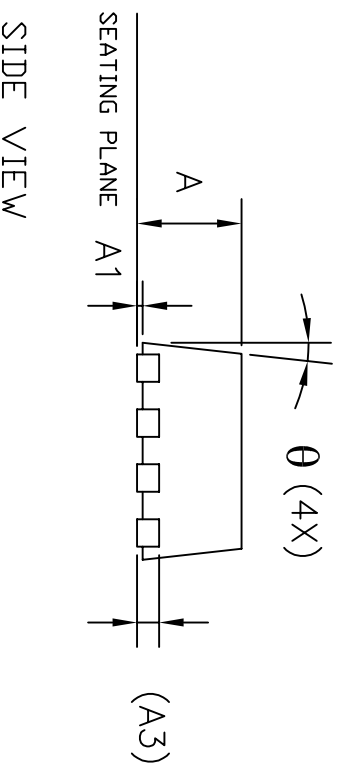
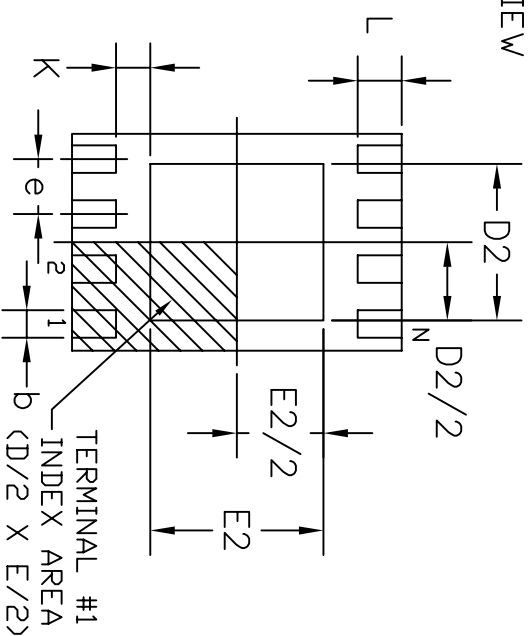

SIDE VIEW

SYMBOLS		DIMENSIONS IN MM (Control Unit)			DIMENSIONS IN INCH (Reference Unit)		
	MIN	NOM	MAX	MIN	NOM	MAX	
A	0.80	0.90	1.00	0.032	0.036	0.039	
A1	0.00	0.02	0.05	0.000	0.001	0.002	
A3	0.20 REF			0.008 REF			
b	0.18	0.25	0.30	0.007	0.010	0.012	
D	2.00 BSC			0.079 BSC			
D2	1.50	—	1.75	0.059	—	0.069	
E	3.00 BSC			0.118 BSC			
E2	1.60	—	1.90	0.063	—	0.075	
e	0.50 BSC			0.020 BSC			
L	0.30	0.40	0.50	0.012	0.016	0.020	
K	0.20	—	—	0.008	—	—	
theta	0°	—	14°	0°	—	14°	
N	8			8			
ND	4			4			

8LD 2x3 DFN JEDEC MO-229 Variation VCED-2



**SIPEX CORPORATION**

8 PIN 2x3 DFN PACKAGE OUTLINE

Packaging Approval:

Drawing No: 8-PIN 2x3 DFN

By: JL Date: 07/17/06

Revision: B Sheet: 1 OF 1

REVISION HISTORY				
REV.	DESCRIPTION	DATE	APP'D	
A	DRAWING ORIGINATION	10/3/05	JL	
B	DRAWING FORMAT MODIFICATION	07/25/06	JL	

Top View

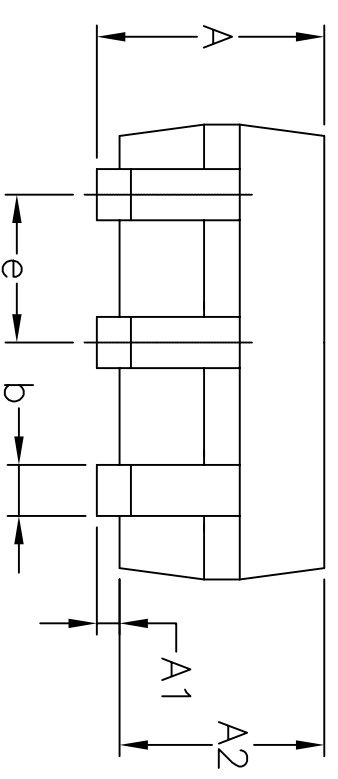
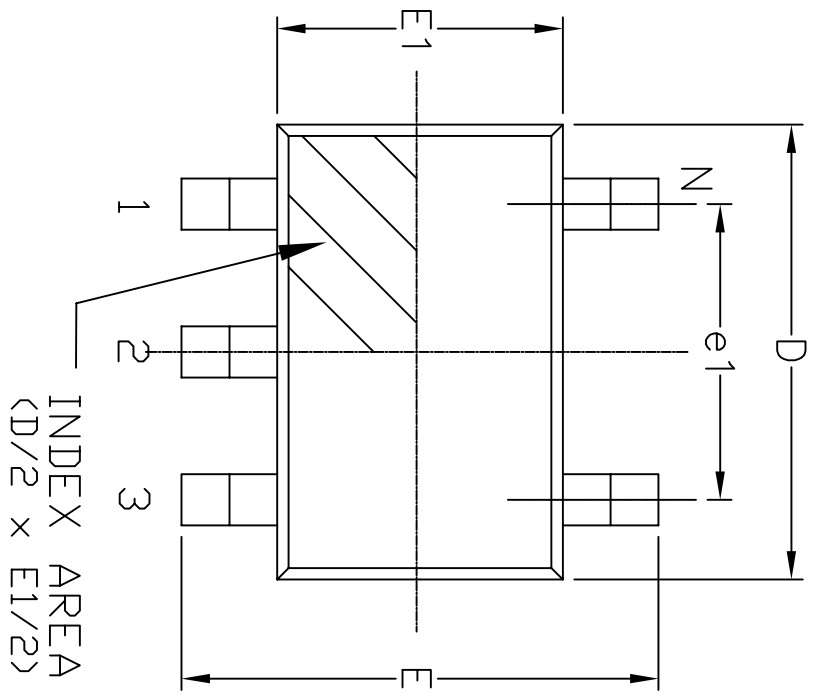

Side View

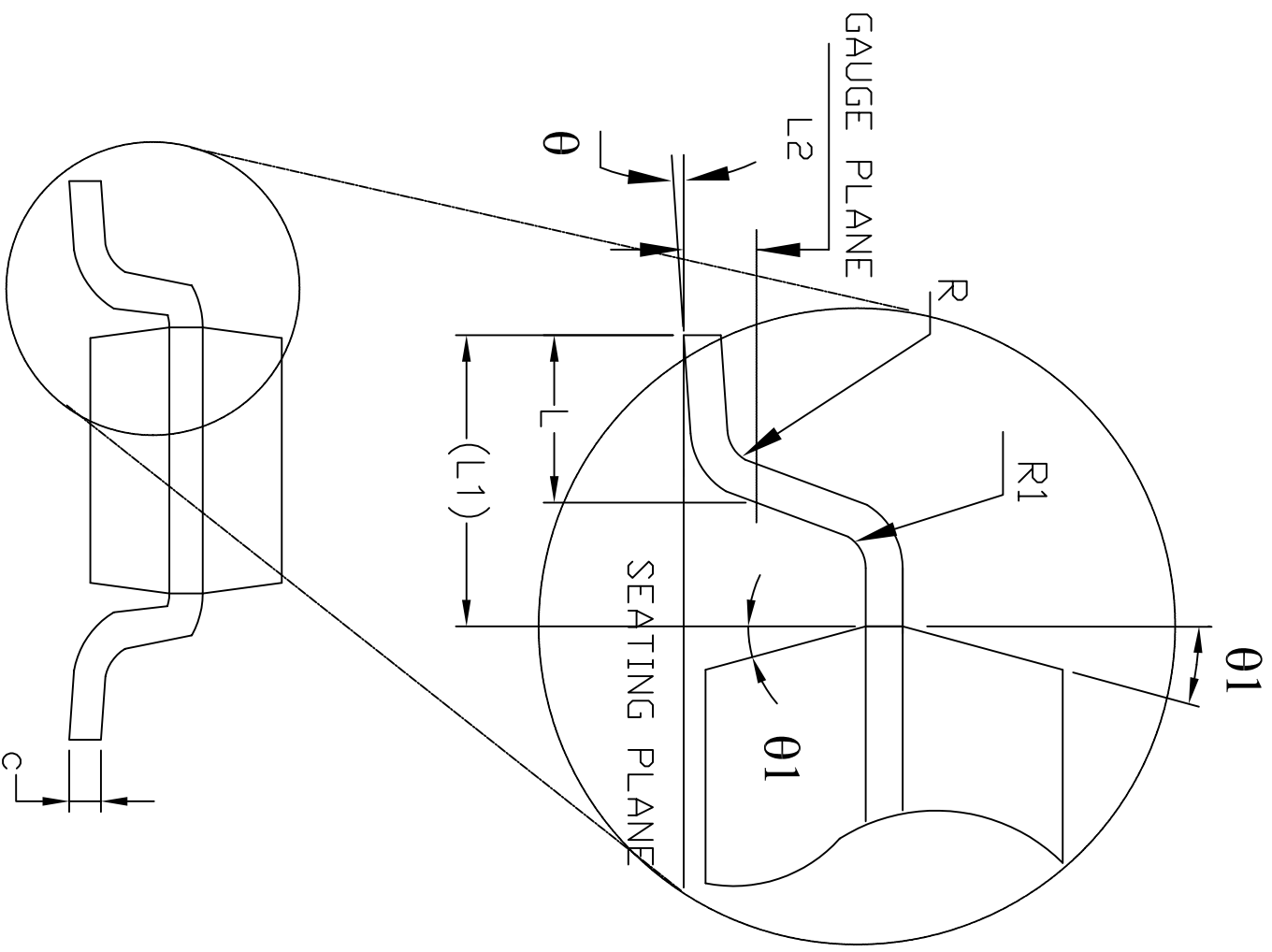

Front View

SYMBOLS	DIMENSIONS IN MM (Control Unit)			DIMENSIONS IN INCH (Reference Unit)		
	MIN	NOM	MAX	MIN	NOM	MAX
A	—	—	1.45	—	—	0.057
A1	0.00	—	0.15	0.000	—	0.006
A2	0.90	1.15	1.30	0.036	0.045	0.051
b	0.30	—	0.50	0.012	—	0.020
c	0.08	—	0.22	0.003	—	0.009
D	2.90 BSC			0.115 BSC		
E	2.80 BSC			0.111 BSC		
E1	1.60 BSC			0.063 BSC		
e	0.95 BSC			0.038 BSC		
e1	1.90 BSC			0.075 BSC		
L	0.30	0.45	0.60	0.012	0.018	0.024
L1	0.60 REF			0.024 REF		
L2	0.25 BSC			0.010 BSC		
R	0.10	—	—	0.004	—	—
R1	0.10	—	0.25	0.004	—	0.010
theta	0°	4°	8°	0°	4°	8°
theta1	5°	10°	15°	5°	10°	15°
N	5			5		

		<b>SIPEX CORPORATION</b>	
Packaging Approval:		Drawing No: 5-PIN SOT-23	
By: JL	Date: 07/25/06	Revision: B	Sheet: 1 OF 1

## ORDERING INFORMATION

Part Number	Accuracy	MSL Level	Status	Package	Pack Type	Quantity	RoHS
SPX3819S-L/TR	0.01	L1 @ 260°C	Active	NSOIC8	Tape & Reel	2500	Yes
SPX3819S-L-1-8/TR	0.01	L1 @ 260°C	Active	NSOIC8	Tape & Reel	2500	Yes
SPX3819S-L-2-5/TR	0.01	L1 @ 260°C	Active	NSOIC8	Tape & Reel	2500	Yes
SPX3819S-L-3-0/TR	0.01	L1 @ 260°C	Active	NSOIC8	Tape & Reel	2500	Yes
SPX3819S-L-3-1/TR	0.01	L1 @ 260°C	Active	NSOIC8	Tape & Reel	2500	Yes
SPX3819S-L-3-3/TR	0.01	L1 @ 260°C	Active	NSOIC8	Tape & Reel	2500	Yes
SPX3819S-L-5-0/TR	0.01	L1 @ 260°C	Active	NSOIC8	Tape & Reel	2500	Yes
SPX3819S-L	0.01	L1 @ 260°C	Active	NSOIC8	TUBE	98	Yes
SPX3819S-L-1-8	0.01	L1 @ 260°C	Active	NSOIC8	TUBE	98	Yes
SPX3819S-L-2-5	0.01	L1 @ 260°C	Active	NSOIC8	TUBE	98	Yes
SPX3819S-L-3-0	0.01	L1 @ 260°C	Active	NSOIC8	TUBE	98	Yes
SPX3819S-L-3-1	0.01	L1 @ 260°C	Active	NSOIC8	TUBE	98	Yes
SPX3819S-L-3-3	0.01	L1 @ 260°C	Active	NSOIC8	TUBE	98	Yes
SPX3819S-L-5-0	0.01	L1 @ 260°C	Active	NSOIC8	TUBE	98	Yes
SPX3819M5-L	0.01	L1 @ 260°C	Active	SOT-23-5	Not in Bulk	2500	Yes
SPX3819M5-L-1-2	0.01	L1 @ 260°C	Active	SOT-23-5	Not in Bulk	2500	Yes
SPX3819M5-L-1-5	0.01	L1 @ 260°C	Active	SOT-23-5	Not in Bulk	2500	Yes
SPX3819M5-L-1-8	0.01	L1 @ 260°C	Active	SOT-23-5	Not in Bulk	2500	Yes
SPX3819M5-L-2-5	0.01	L1 @ 260°C	Active	SOT-23-5	Not in Bulk	2500	Yes
SPX3819M5-L-3-0	0.01	L1 @ 260°C	Active	SOT-23-5	Not in Bulk	2500	Yes
SPX3819M5-L-3-1	0.01	L1 @ 260°C	Active	SOT-23-5	Not in Bulk	2500	Yes
SPX3819M5-L-3-3	0.01	L1 @ 260°C	Active	SOT-23-5	Not in Bulk	2500	Yes
SPX3819M5-L-5-0	0.01	L1 @ 260°C	Active	SOT-23-5	Not in Bulk	2500	Yes
SPX3819M5-L/TR	0.01	L1 @ 260°C	Active	SOT-23-5	Tape & Reel	2500	Yes
SPX3819M5-L-1-2/TR	0.01	L1 @ 260°C	Active	SOT-23-5	Tape & Reel	2500	Yes
SPX3819M5-L-1-5/TR	0.01	L1 @ 260°C	Active	SOT-23-5	Tape & Reel	2500	Yes
SPX3819M5-L-1-8/TR	0.01	L1 @ 260°C	Active	SOT-23-5	Tape & Reel	2500	Yes
SPX3819M5-L-2-5/TR	0.01	L1 @ 260°C	Active	SOT-23-5	Tape & Reel	2500	Yes
SPX3819M5-L-3-0/TR	0.01	L1 @ 260°C	Active	SOT-23-5	Tape & Reel	2500	Yes
SPX3819M5-L-3-1/TR	0.01	L1 @ 260°C	Active	SOT-23-5	Tape & Reel	2500	Yes
SPX3819M5-L-3-3/TR	0.01	L1 @ 260°C	Active	SOT-23-5	Tape & Reel	2500	Yes
SPX3819M5-L-5-0/TR	0.01	L1 @ 260°C	Active	SOT-23-5	Tape & Reel	2500	Yes
SPX3819R2-L-1-2	0.01	L1 @ 250°C	CF	DFN8	Not in Bulk	3000	Yes
SPX3819R2-L-1-2/TR	0.01	L1 @ 250°C	CF	DFN8	Tape & Reel	3000	Yes
SPX3819S-L-1-2/TR	0.01	L1 @ 260°C	CF	SOIC-8	Tape & Reel	2500	Yes
SPX3819S-L-1-5/TR	0.01	L1 @ 260°C	CF	SOIC-8	Tape & Reel	2500	Yes
SPX3819S-L-1-2	0.01	L1 @ 260°C	CF	SOIC-8	TUBE	98	Yes
SPX3819S-L-1-5	0.01	L1 @ 260°C	CF	SOIC-8	TUBE	98	Yes

**ORDERING INFORMATION**

Part Number	Accuracy	MSL Level	Status	Package	Pack Type	Quantity	RoHS
SPX3819R2-L	0.01	L1 @ 250°C	EOL	DFN8	Not in Bulk	3000	Yes
SPX3819R2-L-1-5	0.01	L1 @ 250°C	EOL	DFN8	Not in Bulk	3000	Yes
SPX3819R2-L-1-8	0.01	L1 @ 250°C	EOL	DFN8	Not in Bulk	3000	Yes
SPX3819R2-L-3-3	0.01	L1 @ 250°C	EOL	DFN8	Not in Bulk	3000	Yes
SPX3819R2-L-5-0	0.01	L1 @ 250°C	EOL	DFN8	Not in Bulk	3000	Yes
SPX3819R2-1-2	0.01	L1 @ 240°C	EOL	DFN8	Not in Bulk	3000	No
SPX3819R2-3-3	0.01	L1 @ 240°C	EOL	DFN8	Not in Bulk	3000	No
SPX3819R2-1-2/TR	0.01	L1 @ 240°C	EOL	DFN8	Tape & Reel	3000	No
SPX3819S/TR	0.01	L1 @ 240°C	EOL	NSOIC8	Tape & Reel	2500	No
SPX3819S-2-5/TR	0.01	L1 @ 240°C	EOL	NSOIC8	Tape & Reel	2500	No
SPX3819S	0.01	L1 @ 240°C	EOL	NSOIC8	TUBE	98	No
SPX3819S-2-5	0.01	L1 @ 240°C	EOL	NSOIC8	TUBE	98	No
SPX3819S-3-3/TR	0.01	L1 @ 240°C	EOL	SOIC-8	Tape & Reel	2500	No
SPX3819S-1-8	0.01	L1 @ 240°C	EOL	SOIC-8	TUBE	98	No
SPX3819S-3-3	0.01	L1 @ 240°C	EOL	SOIC-8	TUBE	98	No
SPX3819S-5-0	0.01	L1 @ 240°C	EOL	SOIC-8	TUBE	98	No
SPX3819M5	0.01	L1 @ 240°C	EOL	SOT-23-5	Not in Bulk	2500	No
SPX3819M5-1-2	0.01	L1 @ 240°C	EOL	SOT-23-5	Not in Bulk	2500	No
SPX3819M5-1-5	0.01	L1 @ 240°C	EOL	SOT-23-5	Not in Bulk	2500	No
SPX3819M5-1-8	0.01	L1 @ 240°C	EOL	SOT-23-5	Not in Bulk	2500	No
SPX3819M5-2-5	0.01	L1 @ 240°C	EOL	SOT-23-5	Not in Bulk	2500	No
SPX3819M5-3-0	0.01	L1 @ 240°C	EOL	SOT-23-5	Not in Bulk	2500	No
SPX3819M5-3-1	0.01	L1 @ 240°C	EOL	SOT-23-5	Not in Bulk	2500	No
SPX3819M5-3-3	0.01	L1 @ 240°C	EOL	SOT-23-5	Not in Bulk	2500	No
SPX3819M5-5-0	0.01	L1 @ 240°C	EOL	SOT-23-5	Not in Bulk	2500	No
SPX3819M5/TR	0.01	L1 @ 240°C	EOL	SOT-23-5	Tape & Reel	2500	No
SPX3819M5-1-2/TR	0.01	L1 @ 240°C	EOL	SOT-23-5	Tape & Reel	2500	No
SPX3819M5-1-5/TR	0.01	L1 @ 240°C	EOL	SOT-23-5	Tape & Reel	2500	No
SPX3819M5-1-8/TR	0.01	L1 @ 240°C	EOL	SOT-23-5	Tape & Reel	2500	No
SPX3819M5-2-5/TR	0.01	L1 @ 240°C	EOL	SOT-23-5	Tape & Reel	2500	No
SPX3819M5-3-0/TR	0.01	L1 @ 240°C	EOL	SOT-23-5	Tape & Reel	2500	No
SPX3819M5-3-3/TR	0.01	L1 @ 240°C	EOL	SOT-23-5	Tape & Reel	2500	No
SPX3819M5-5-0/TR	0.01	L1 @ 240°C	EOL	SOT-23-5	Tape & Reel	2500	No

For further assistance:

Email: [Sipexsupport@sipex.com](mailto:Sipexsupport@sipex.com)  
 WWW Support page: <http://www.sipex.com/content.aspx?p=support>  
 Sipex Application Notes: <http://www.sipex.com/applicationNotes.aspx>



Sipex Corporation  
 Headquarters and  
 Sales Office  
 233 South Hillview Drive  
 Milpitas, CA 95035  
 tel: (408) 934-7500  
 fax: (408) 935-7600

Sipex Corporation reserves the right to make changes to any products described herein. Sipex does not assume any liability arising out of the application or use of any product or circuit described herein; neither does it convey any license under its patent rights nor the rights of others.

**Part Number:** SPX3819

**Date:** Sept14-06

**Question:**

Assuming a nominal load of 250mA @ 3V DC, how much ground current will be consumed? With a 6V input, will the part even get warm? How about with a 12V input?

**Answer:**

The SPX3819 data sheet contains a graph of ground current vs load current for your review.

Also we suggest that you download the Thermal Considerations application note which includes a few example calculations from the SPX3819:

<http://www.sipex.com/files/ApplicationNotes/LDOThermal.pdf>

The Linear Regulator Heat Calculator could also prove helpful:

<http://www.sipex.com/files/ApplicationNotes/ThermalCalculator.xls>

Customer bench testing is strongly recommended using intended application circuit to ensure proper operation.

**Question:**

Is this part similar to your SP6203 CMOS part in the above regard? Or, is it like a conventional regulator (LM7805) where the excess voltage turns into heat?

**Answer:**

All LDO's will transfer most of its energy to heat. To minimize this temperature rise keep the input to output voltage difference slightly above dropout voltage. See the applications note mentioned above.

**Question:**

Can ceramic capacitors be used on the output?

**Answer:**

Ceramic capacitors may be used for this part. For Tantalum or Aluminum Electrolytic types, keep the Equivalent Series Resistance (ESR) as small as possible.

**Question:**

Considering the PSRR is 70db, what is a better strategy for filtering the 60Hz ripple from the wall cube? A big high voltage electrolytic on the input or a smaller, low voltage ceramic on the output? Or, a combination of both?

**Answer:**

A small common mode choke would be best for filtering this ripple. Variations / combinations of input capacitance might also help but bench testing would be required.

**Question:**

Is there any practical limit to how much capacitance is used on the input or output?

**Answer:**

Input and output capacitance may be increased without limit.

**Question:**

It would appear, from the data sheet, increasing the Bypass capacitor above 0.01uF has little improvement in terms of noise. We use a special low ESL/ESR 0.1uF ceramic as standard for RF bypassing. Any concerns about using these on your Bypass pin as well?

**Answer:**

If the bypass pin is to be used a 10nF ceramic capacitor is suggested. You may also use the value / type mentioned. The only concern with the bypass feature is that startup time is increased. If startup time is a concern then the bypass pin should be kept open. Different values of bypass capacitor will result in different startup times.

**Question:**

A portion of this application involves modulating a IR LED with a 400KHz signal having a 50% duty cycle or less. Assuming a drive level of 1 AMP per 25µS pulse, will your device even see this as an overload and go into current limiting? If so, should a large electrolytic be employed on the output?

**Answer:**

This is a little difficult to answer not knowing how you plan on modulating the LED. If the enable input is used for modulation it is possible that the device may not react fast enough to provide an output. This is very much true if the Bypass pin is used. If the output load exceeds the current limit trip point then the output will be turned off to protect the device. However, if the output is always on and modulation is done with some external circuitry, then adding extra capacitance to the output could satisfy the current demand of the LED so as not to cause current limit activation.

**Question:**

This part is quite attractive in terms of its Reverse Battery Protection feature. Do you have any other more current/better alternatives?

**Answer:**

For a 500mA output current device this is the best Sipex offers for package size and performance. Check our LDO products page for all of Sipex LDO offerings.

<http://www.sipex.com/productselector.aspx?family=LowDropOut>



**Question:**

If a 3V battery pack was connected to the output, without a “wall wart” connected to the input, would any current flow back through the device?

**Answer:**

The datasheet does not state that this device is operable in a pre-biased output condition; therefore, leakage may occur.

**Question:**

If the 3V battery pack was connected to the input, what would the output voltage be with a 250mA load?

**Answer:**

If the input voltage is above dropout voltage then the part will regulate for the entire output current range up to 500mA.



# **Product Characterization Report**

for the

## **SPX5205 Family of Products**

**SPX3819, SPX5205 Products**

**Prepared By: Velvet Doung, Salvador Wu & Greg West**

**Date: October 6, 2006**



## Table of Contents

<u>Section</u>	<u>Page</u>
Introduction	3
Characterization Procedure	3
Data Summary for Key Parameters	4
Conclusions	6
Data Histograms	Appendix A



SPX5205  
Product Family  
Characterization Report

**Introduction:** This product family characterization was done as part of the qualification of Sipex's fabrication site transfer from Sipex's Hillview Fab in Milpitas, CA, to a contract foundry, Silan, in Hangzhou, China. This characterization report summarizes data for key SPX5205 product family characteristics and contains distributions for all parameters. A complete listing of the product numbers covered by the characterization report is included in the "Conclusion" section of this report. A distribution for a given parameter shows different temperature data which are at -40°C, 25°C, and 85°C.

Wafer Fab: Silan  
Fab Location: Hangzhou, China  
Process: Silan – bp4  
MS: 1631

**Characterization Procedure:**

Silan Lot number(s): CA10068  
Hillview Lot number(s): A133102  
Temperatures: Ambient (25C), 85C, -40C  
Tester: TMT  
Test Program: SPX5205\_S\_33\_01\_FT



SPX5205  
Product Family  
Characterization Report

**Data Summary:**

**Key Parameter Across Temperature Data Summary**

Parameter	Units	Hillview Fab Distribution Mean	Hillview Fab Distribution Variance	Hillview Fab Cpk		Silan Fab Distribution Mean	Silan Fab Distribution Variance	Silan Fab Cpk
<b>-40C</b>								
Vout@1mA	V	3.3063	0.0145	0.1453		3.3101	0.0145	0.2313
Vout@150mA	V	3.3059	0.0143	0.1377		3.3096	0.0146	0.2201
Load Reg	%	0.0163	0.0239	2.5591		0.0155	0.0124	>4.0000
Vout@16V	V	3.3033	0.0146	0.0755		3.3066	0.0160	0.1374
Vout@Ven16V	V	3.3031	0.0146	0.0698		3.3084	0.0159	0.1756
Line Reg	%/V	0.0095	0.0022	>4.0000		0.0106	0.0092	3.2365
Vdrop@100uA	mV	4.4206	0.4011	>4.0000		4.8494	0.1847	>4.0000
Vdrop@150mA	mV	165.9586	5.1199	>4.0000		171.5026	3.1504	>4.0000
Ien_Hi	uA	2.5512	0.7638	>4.0000		6.6740	0.6094	>4.0000
Ien_Lo	uA	0.0766	0.0507	>4.0000		0.0418	0.0348	>4.0000
Iq	uA	0.1293	0.1387	2.0921		0.1244	0.1015	2.8759
Ignd@100uA	uA	65.9978	5.4764	3.5913		61.9901	12.8836	1.6302
Ignd@150mA	mA	0.1791	0.0095	>4.0000		0.1367	0.0136	>4.0000
Ilim	mA	245.0682	0.7598	>4.0000		244.7949	1.0248	>4.0000
<b>25C</b>								
Vout@1mA	V	3.3116	0.0127	0.3030		3.3155	0.0052	0.9831
Vout@150mA	V	3.3101	0.0127	0.2635		3.3140	0.0051	0.9141
Load Reg	%	0.0454	0.0133	3.8768		0.0434	0.0161	3.2412
Vout@16V	V	3.3063	0.0127	0.1658		3.3113	0.0053	0.7049
Vout@Ven16V	V	3.3063	0.0127	0.1654		3.3113	0.0054	0.7008
Line Reg	%/V	0.0154	0.0012	>4.0000		0.0125	0.0029	>4.0000
Vdrop@100uA	mV	5.8073	0.4263	>4.0000		6.2024	0.1236	>4.0000
Vdrop@150uA	mV	198.4826	1.4465	>4.0000		202.5361	1.1720	>4.0000
Ien_Hi	uA	2.0744	0.5860	>4.0000		5.6495	0.7200	>4.0000
Ien_Lo	uA	0.0889	0.0381	>4.0000		0.0491	0.0227	>4.0000
Iq	uA	0.0712	0.0202	>4.0000		0.0848	0.0140	>4.0000
Ignd@100uA	uA	67.5626	3.5699	>4.0000		68.1415	3.3238	>4.0000
Ignd@150uA	mA	0.1561	0.0103	>4.0000		0.1256	0.0077	>4.0000
Ilim	mA	246.5068	0.5756	>4.0000		247.4643	0.5002	>4.0000



SPX5205  
Product Family  
Characterization Report

<b>85C</b>								
<b>Vout@1mA</b>	<b>V</b>	3.2970	0.0109	-0.0910		3.2998	0.0058	-0.0113
<b>Vout@150mA</b>	<b>V</b>	3.2945	0.0109	-0.1690		3.2950	0.0058	-0.2835
<b>Load Reg</b>	<b>%</b>	0.0768	0.0226	1.8173		0.1440	0.0261	0.7146
<b>Vout@16V</b>	<b>V</b>	3.3219	0.0150	0.4887		3.3184	0.0062	0.9950
<b>Vout@Ven16V</b>	<b>V</b>	3.3189	0.0143	0.4418		3.3188	0.0097	0.6478
<b>Line Reg</b>	<b>%/V</b>	0.0366	0.0160	1.3243		0.0310	0.0172	1.3345
<b>Vdrop@100uA</b>	<b>mV</b>	7.3246	0.4241	>4.0000		8.0661	0.1438	>4.0000
<b>Vdrop@150uA</b>	<b>mV</b>	234.8495	2.2662	>4.0000		239.0377	1.8582	>4.0000
<b>Ien_Hi</b>	<b>uA</b>	1.7742	0.4554	>4.0000		4.6596	0.3992	>4.0000
<b>Ien_Lo</b>	<b>uA</b>	0.1911	0.0379	>4.0000		0.1981	0.0446	>4.0000
<b>Iq</b>	<b>uA</b>	2.2378	0.6659	-0.6196		1.5455	0.3054	-0.5954
<b>Ignd@100uA</b>	<b>uA</b>	65.8955	3.1628	>4.0000		64.1807	3.4968	>4.0000
<b>Ignd@150uA</b>	<b>mA</b>	0.1215	0.0122	>4.0000		0.0960	0.0086	>4.0000
<b>Ilim</b>	<b>mA</b>	236.4959	0.8179	>4.0000		236.7823	0.6988	>4.0000



SPX5205  
Product Family  
Characterization Report

**Conclusion:**

Characterization data over temperature and Vcc range show datasheet parameters meet the spec. Cpk's for most parameters are comparable between Hillview and Silan although many show a strong temperature dependence that tends to produce lower Cpk's in this analysis.

The performance of SPX5205 parts fabricated at Silan are comparable to the current SPX5205 parts built from the Hillview fab.

This characterization report applies to the following SPX5205 family of product part numbers:

SPX3819A1-3-3	SPX3819R2-1-5	SPX3819S-L-3-3	SPX3819U-L-3-0
SPX3819A1-L-3-3	SPX3819R2-1-8	SPX3819S-L-5-0	SPX3819U-L-3-1
SPX3819M3-1-8	SPX3819R2-2-5	SPX3819T-1-8	SPX3819U-L-3-3
SPX3819M3-3-0	SPX3819R2-3-0	SPX3819T-3-0	SPX3819U-L-5-0
SPX3819M3-3-1	SPX3819R2-3-1	SPX3819T-3-1	SPX5205M5
SPX3819M3-3-3	SPX3819R2-3-3	SPX3819T-3-3	SPX5205M5-1-2
SPX3819M3-L-1-8	SPX3819R2-5-0	SPX3819T5-1-8	SPX5205M5-1-5
SPX3819M3-L-3-0	SPX3819R2-L	SPX3819T5-3-0	SPX5205M5-1-8
SPX3819M3-L-3-1	SPX3819R2-L-1-2	SPX3819T5-3-1	SPX5205M5-2-0
SPX3819M3-L-3-3	SPX3819R2-L-1-5	SPX3819T5-3-3	SPX5205M5-2-5
SPX3819M5	SPX3819R2-L-1-8	SPX3819T5-L-1-8	SPX5205M5-2-8
SPX3819M5-1-2	SPX3819R2-L-2-5	SPX3819T5-L-3-0	SPX5205M5-3-0
SPX3819M5-1-5	SPX3819R2-L-3-0	SPX3819T5-L-3-1	SPX5205M5-3-3
SPX3819M5-1-8	SPX3819R2-L-3-1	SPX3819T5-L-3-3	SPX5205M5-5-0
SPX3819M5-2-5	SPX3819R2-L-3-3	SPX3819T-L-1-8	SPX5205M5-L
SPX3819M5-3-0	SPX3819R2-L-5-0	SPX3819T-L-3-0	SPX5205M5-L-1-2
SPX3819M5-3-1	SPX3819S	SPX3819T-L-3-1	SPX5205M5-L-1-5
SPX3819M5-3-3	SPX3819S-1-8	SPX3819T-L-3-3	SPX5205M5-L-1-8
SPX3819M5-5-0	SPX3819S-2-5	SPX3819U	SPX5205M5-L-2-0
SPX3819M5-L	SPX3819S-3-0	SPX3819U-1-8	SPX5205M5-L-2-5
SPX3819M5-L-1-2	SPX3819S-3-1	SPX3819U-2-5	SPX5205M5-L-2-8
SPX3819M5-L-1-5	SPX3819S-3-3	SPX3819U-3-0	SPX5205M5-L-3-0
SPX3819M5-L-1-8	SPX3819S-5-0	SPX3819U-3-1	SPX5205M5-L-3-3
SPX3819M5-L-2-5	SPX3819S-L	SPX3819U-3-3	SPX5205M5-L-5-0
SPX3819M5-L-3-0	SPX3819S-L-1-2	SPX3819U-5-0	
SPX3819M5-L-3-1	SPX3819S-L-1-5	SPX3819U5-3-3	
SPX3819M5-L-3-3	SPX3819S-L-1-8	SPX3819U5-L-3-3	
SPX3819M5-L-5-0	SPX3819S-L-2-5	SPX3819U-L	
SPX3819R2	SPX3819S-L-3-0	SPX3819U-L-1-8	
SPX3819R2-1-2	SPX3819S-L-3-1	SPX3819U-L-2-5	



SPX5205  
Product Family  
Characterization Report

## **Appendix A**

# **Characterization Data Histograms**



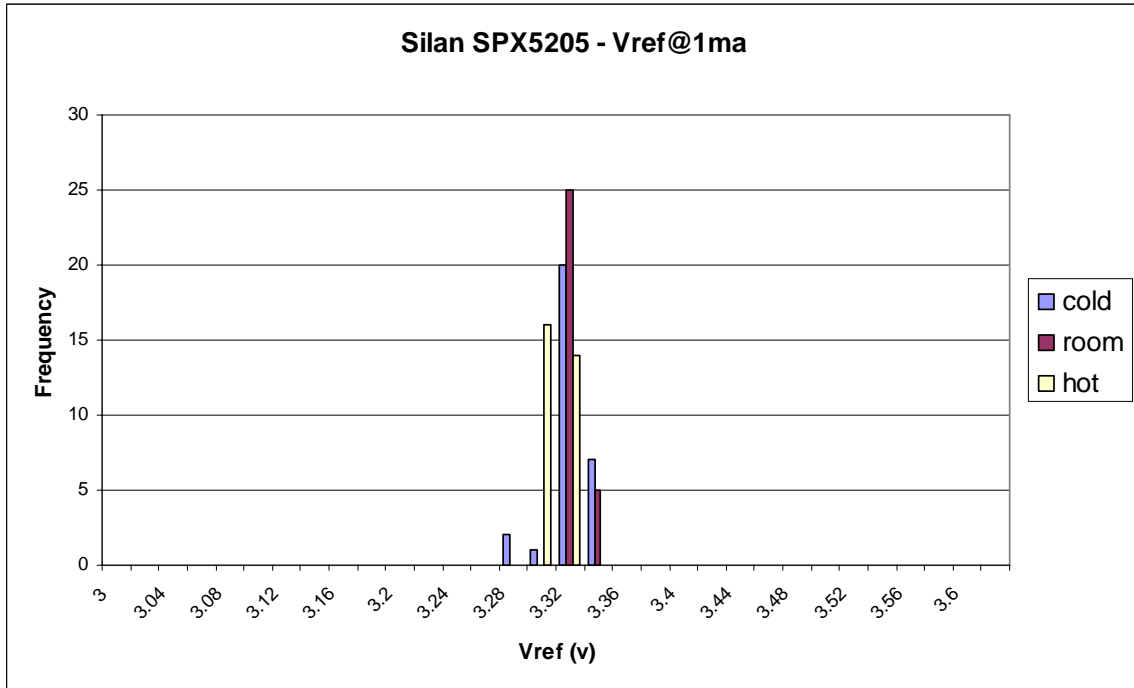
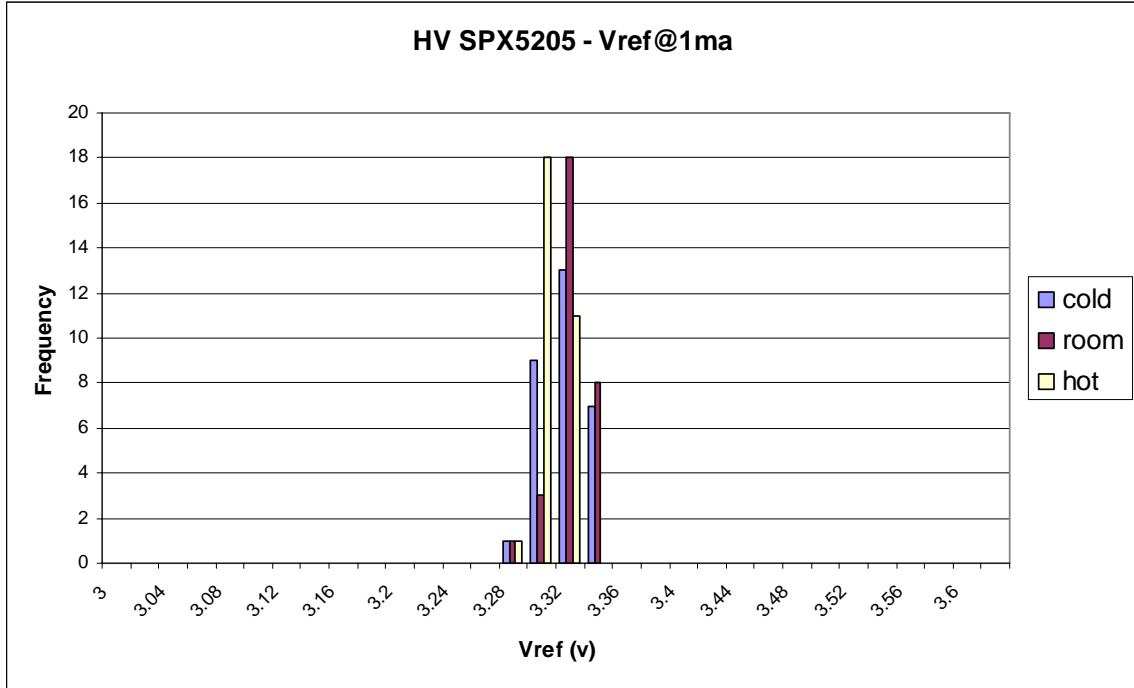

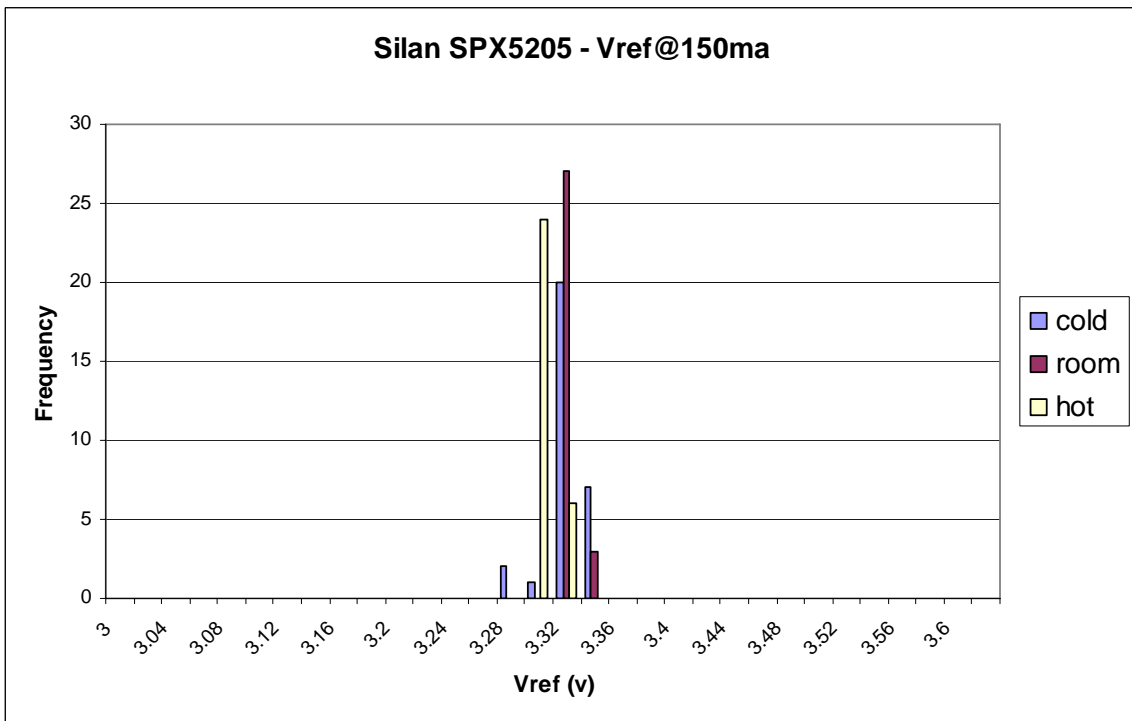
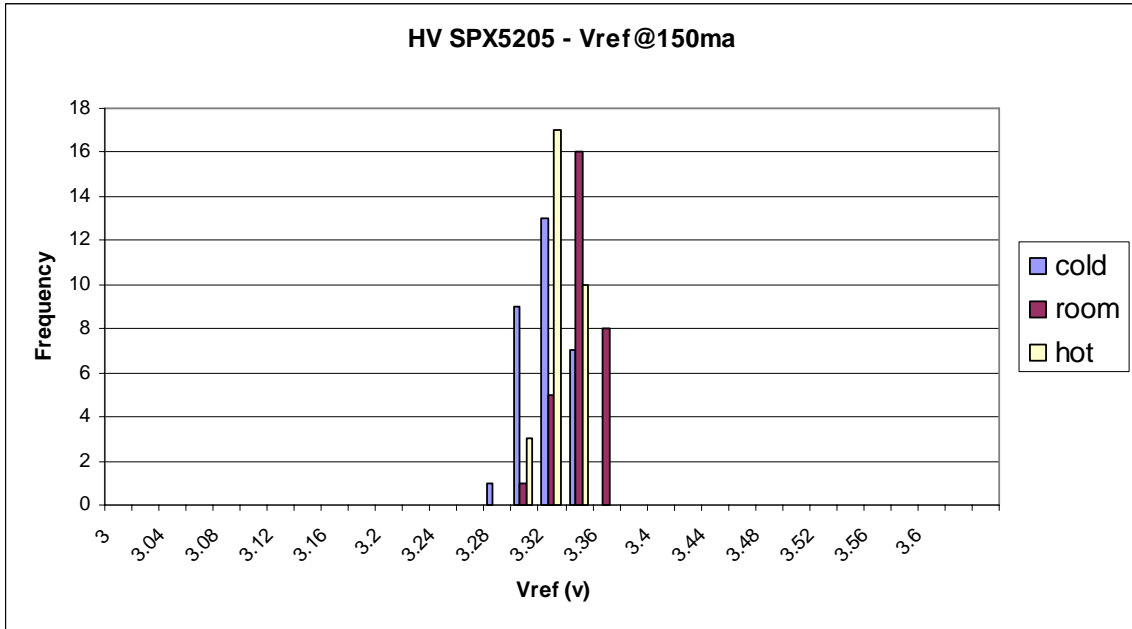

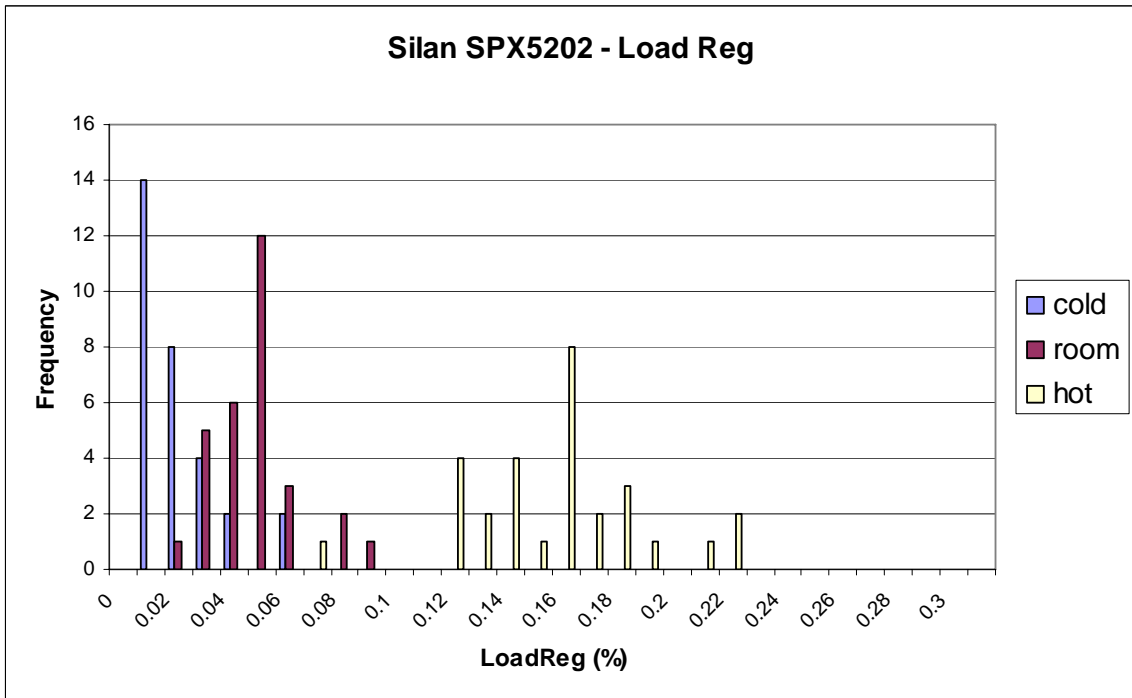
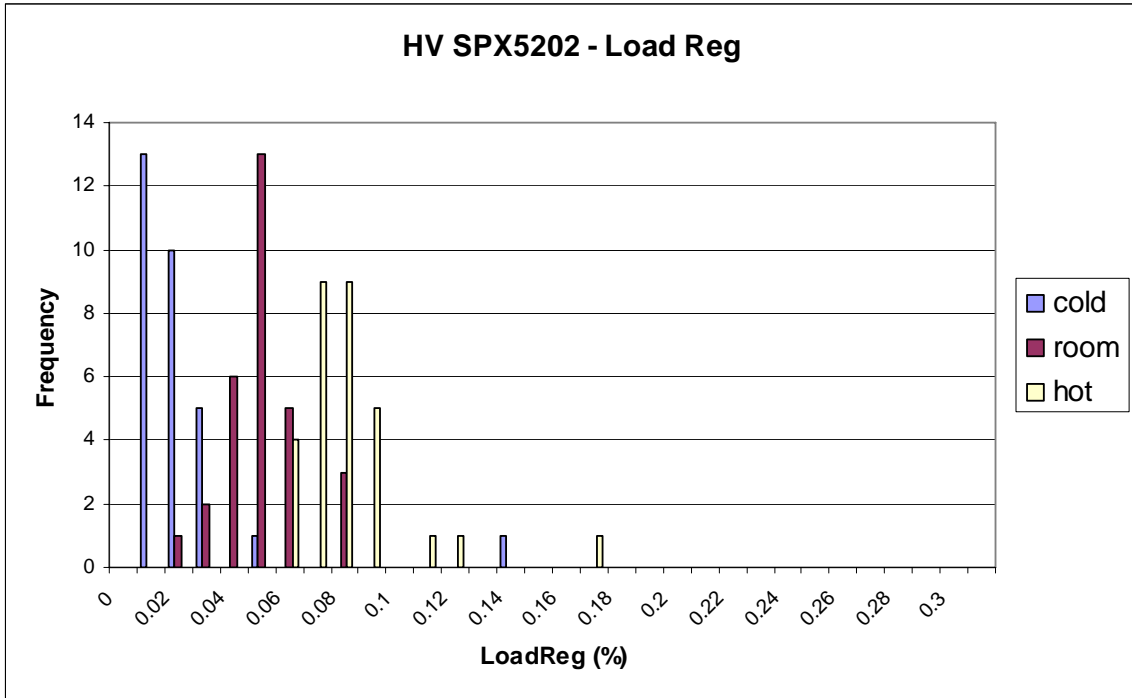

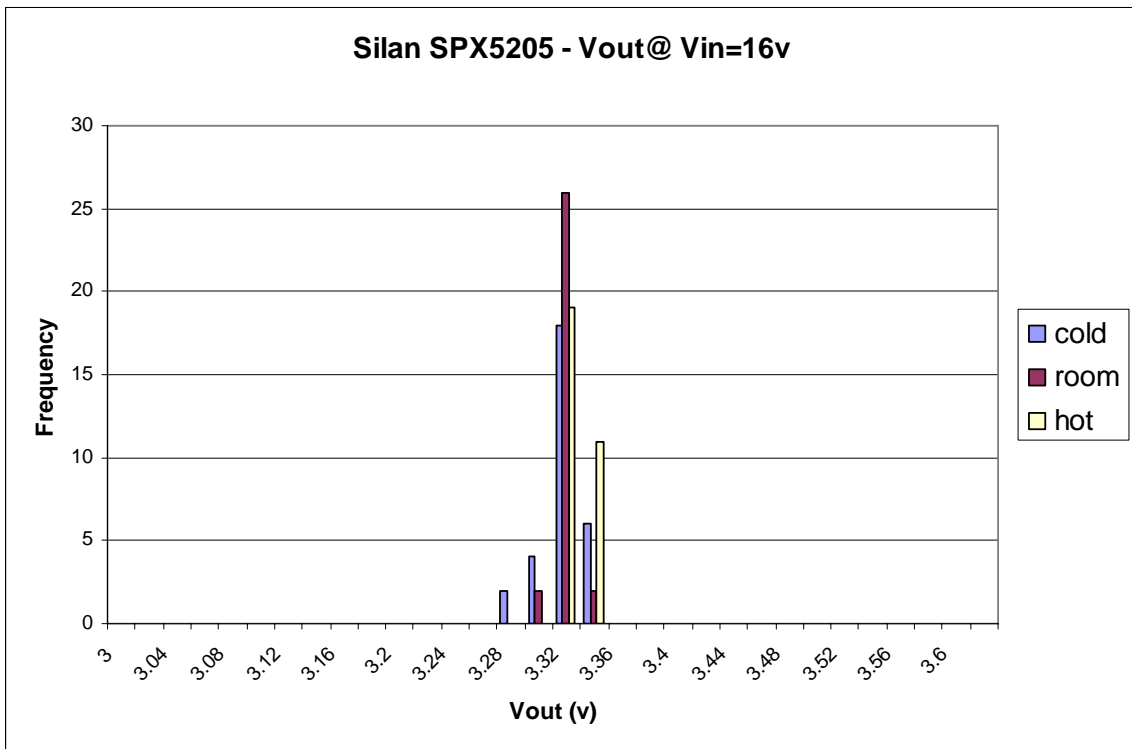
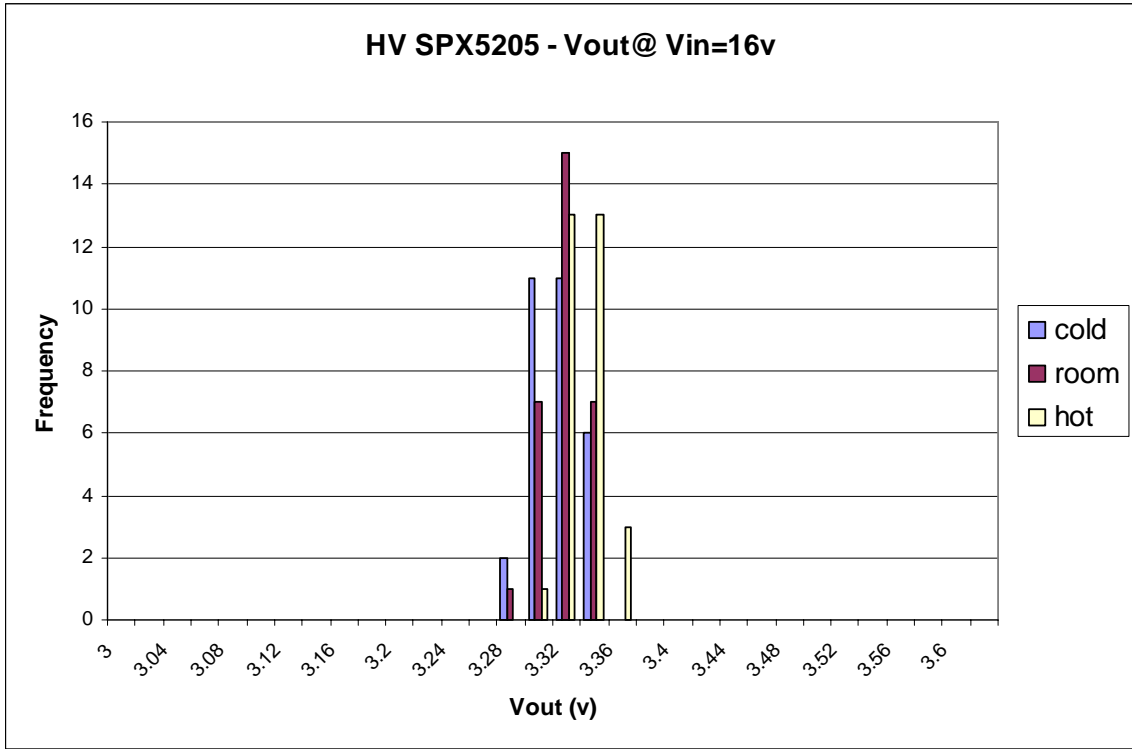

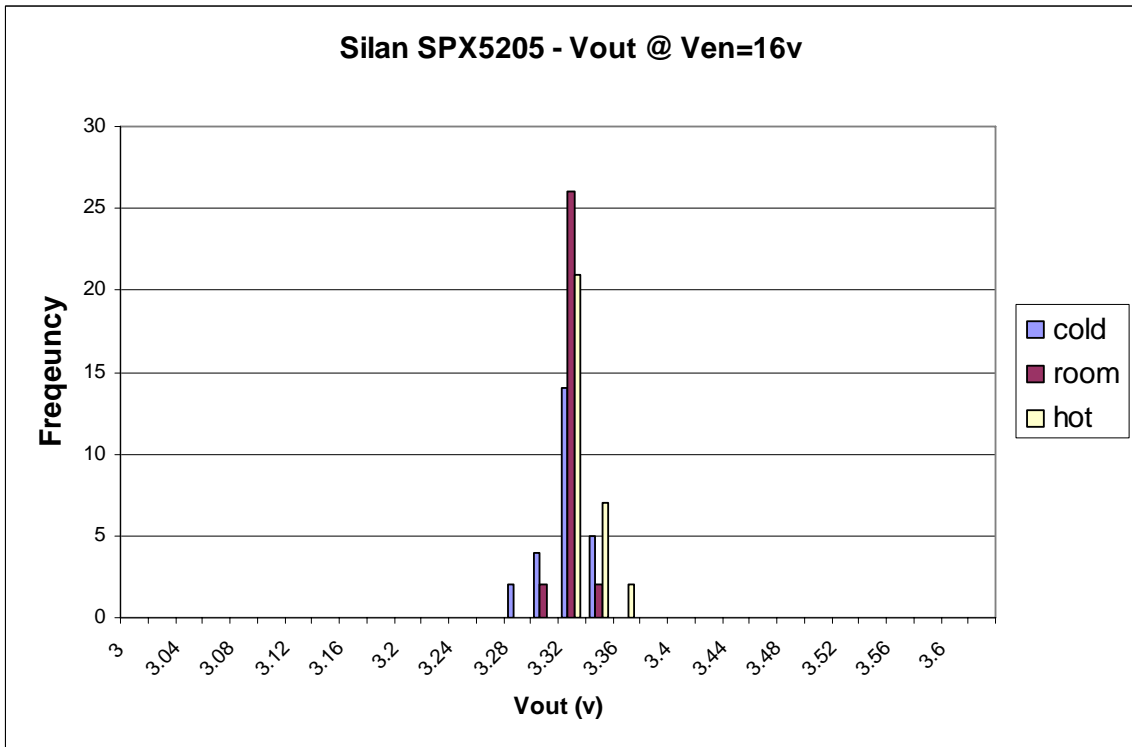
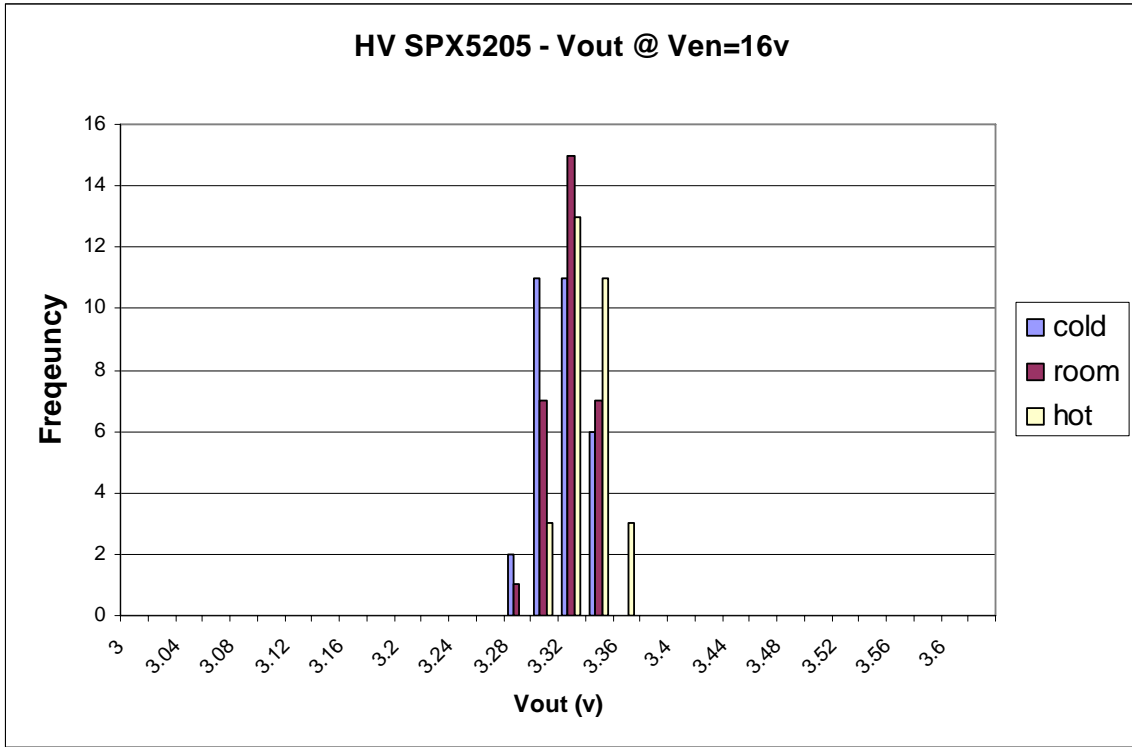

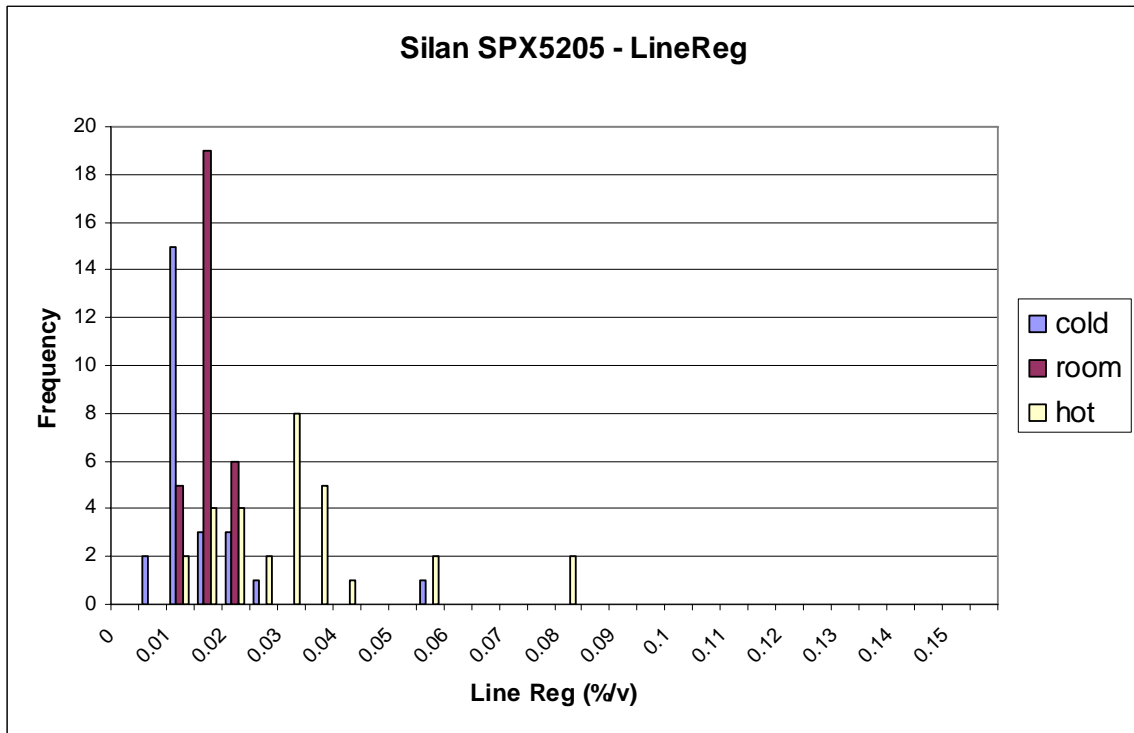
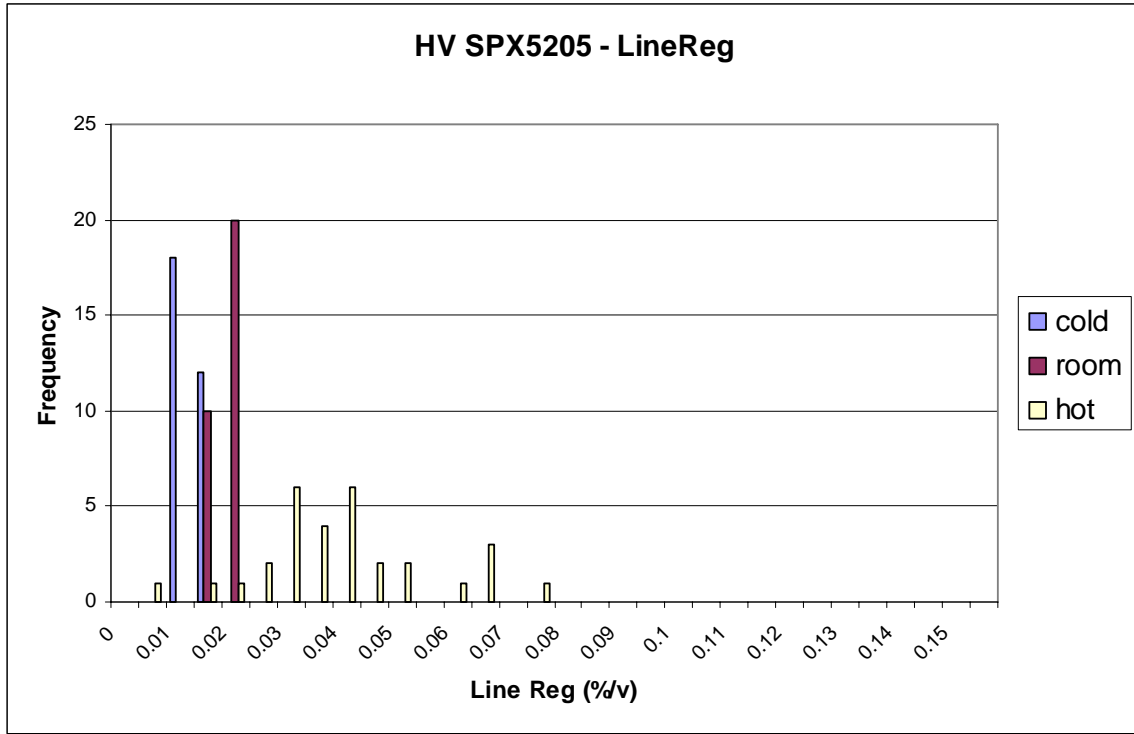

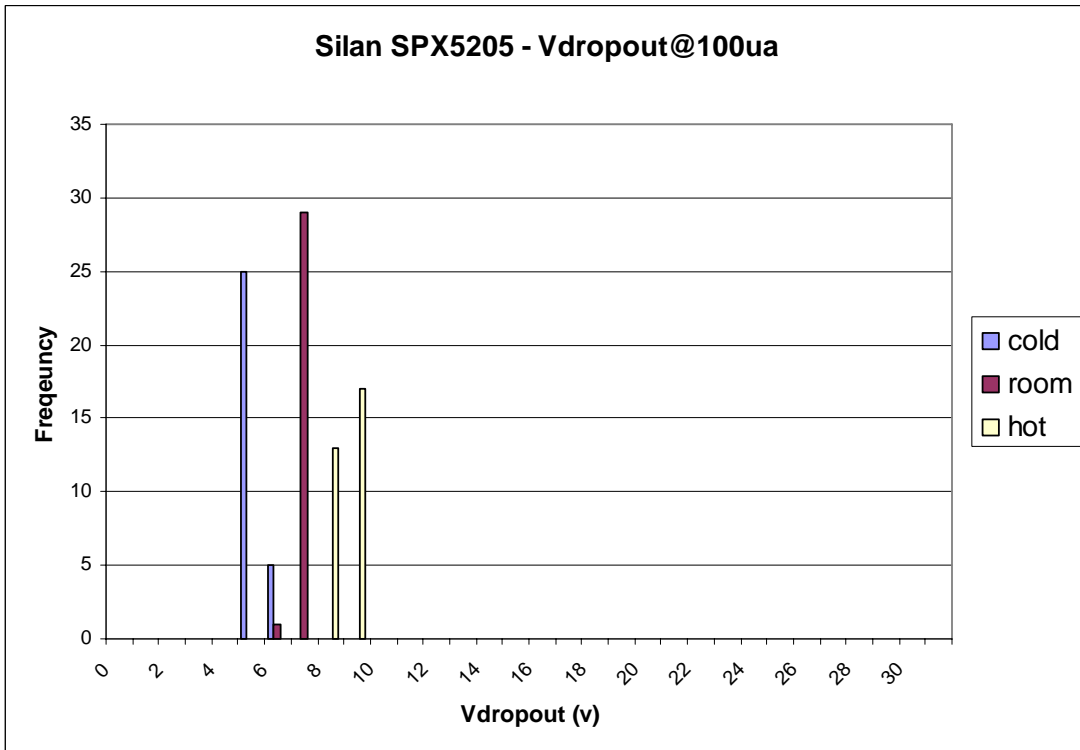
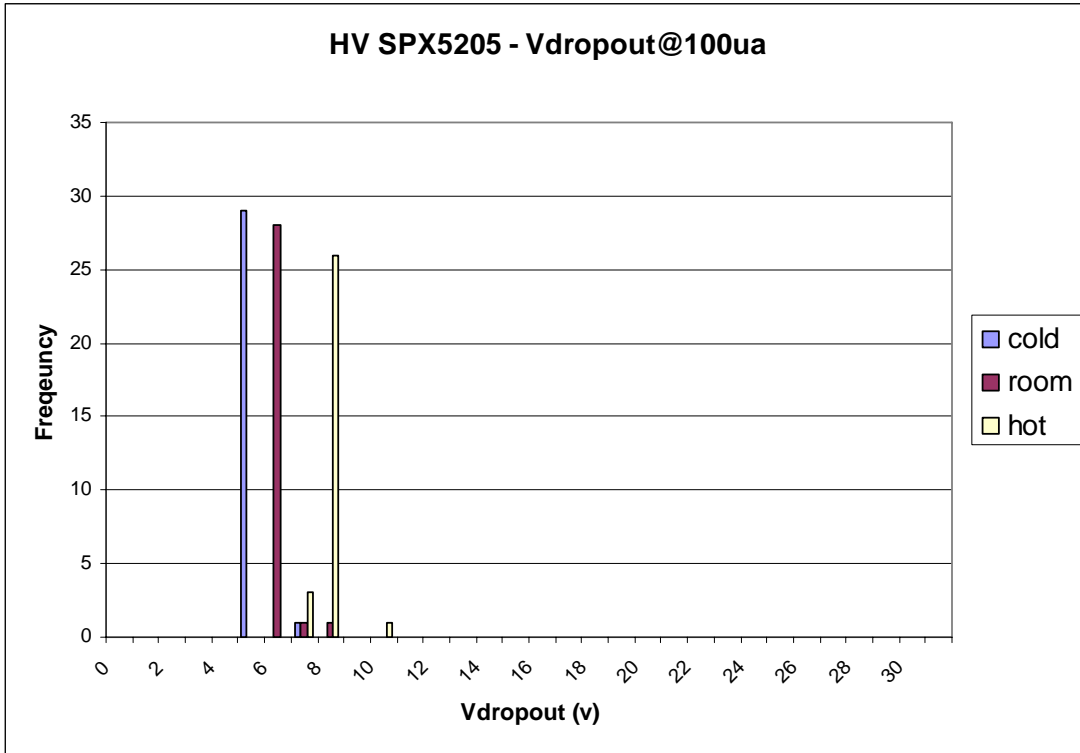

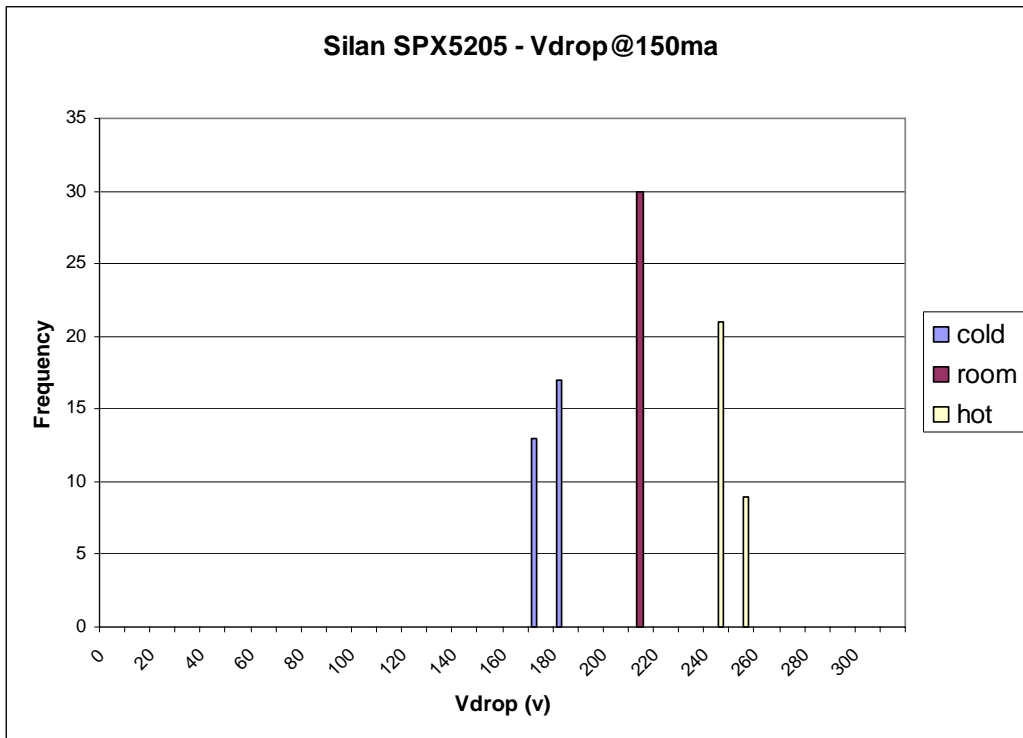
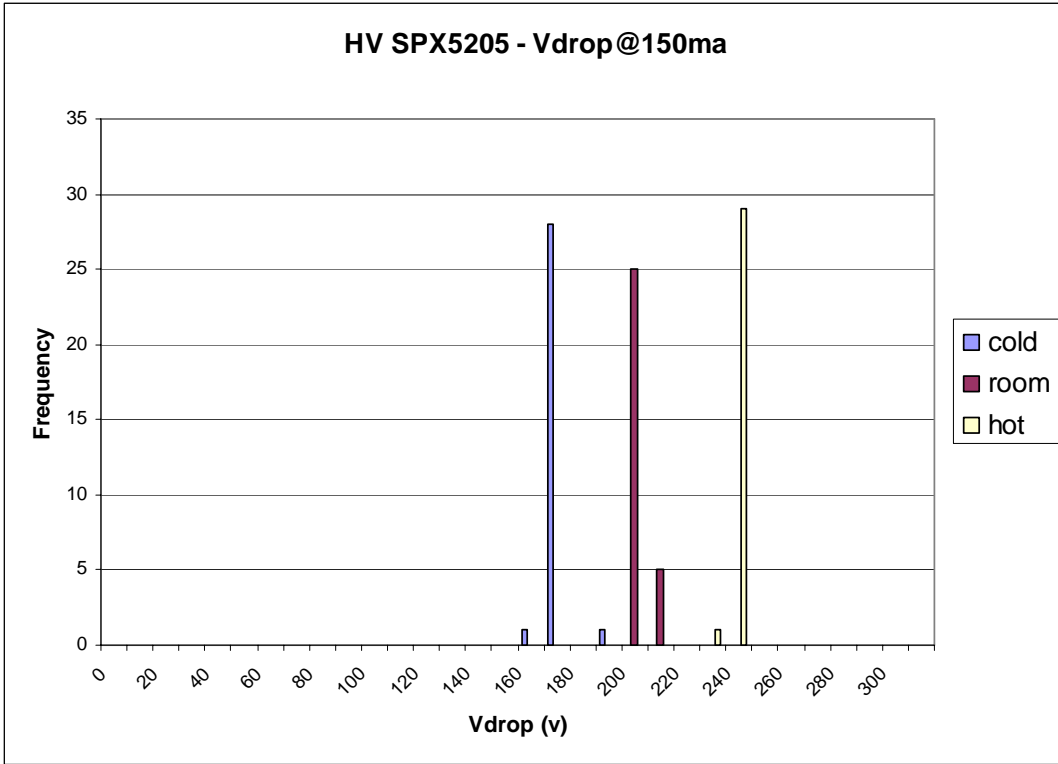



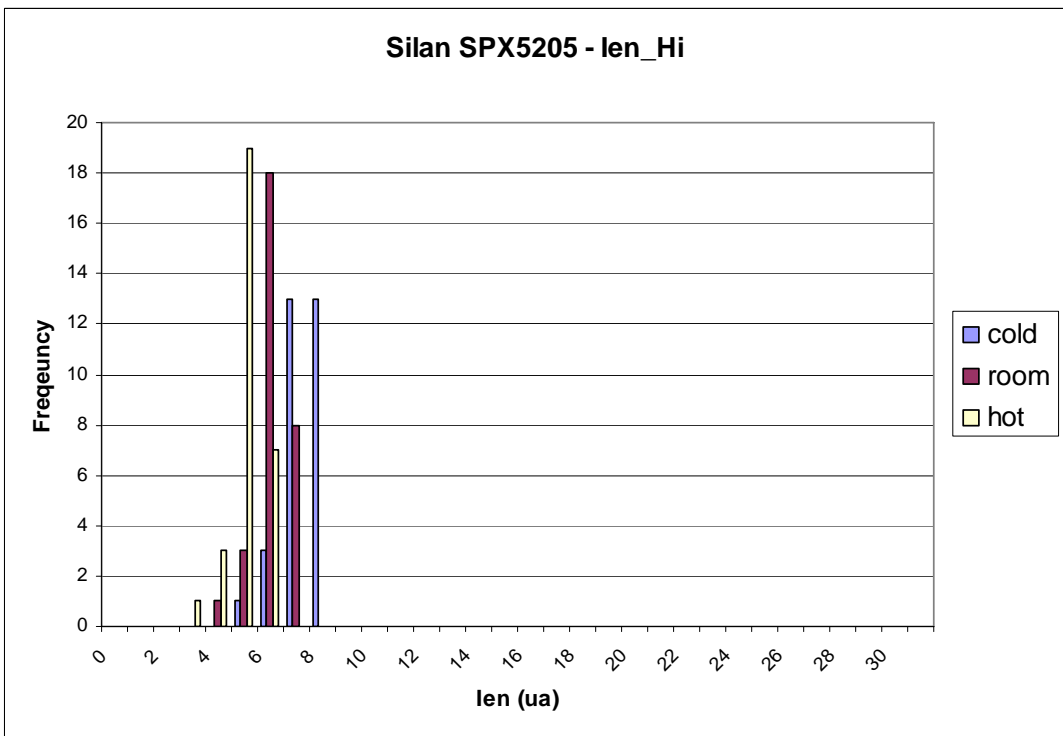
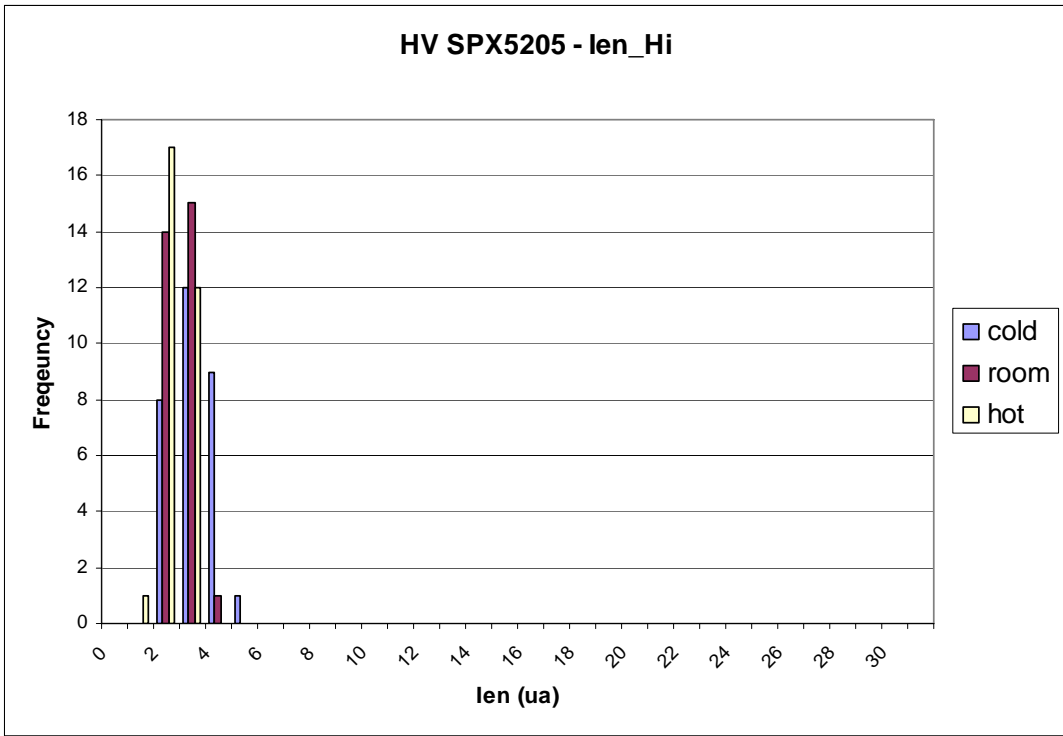

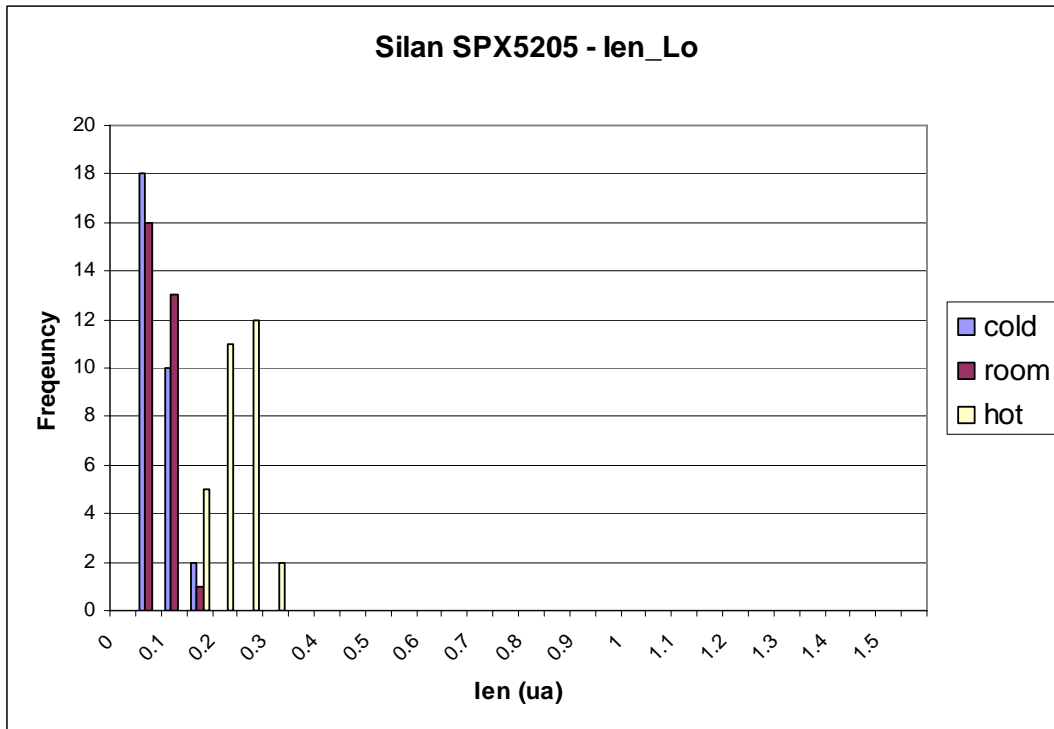
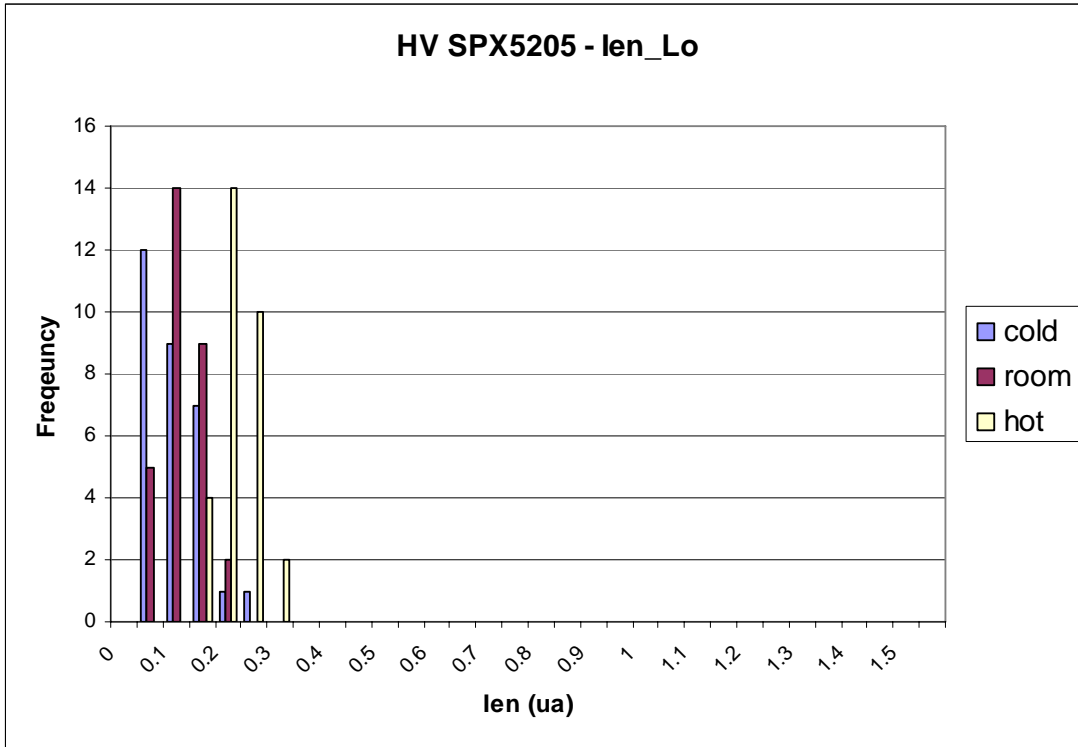

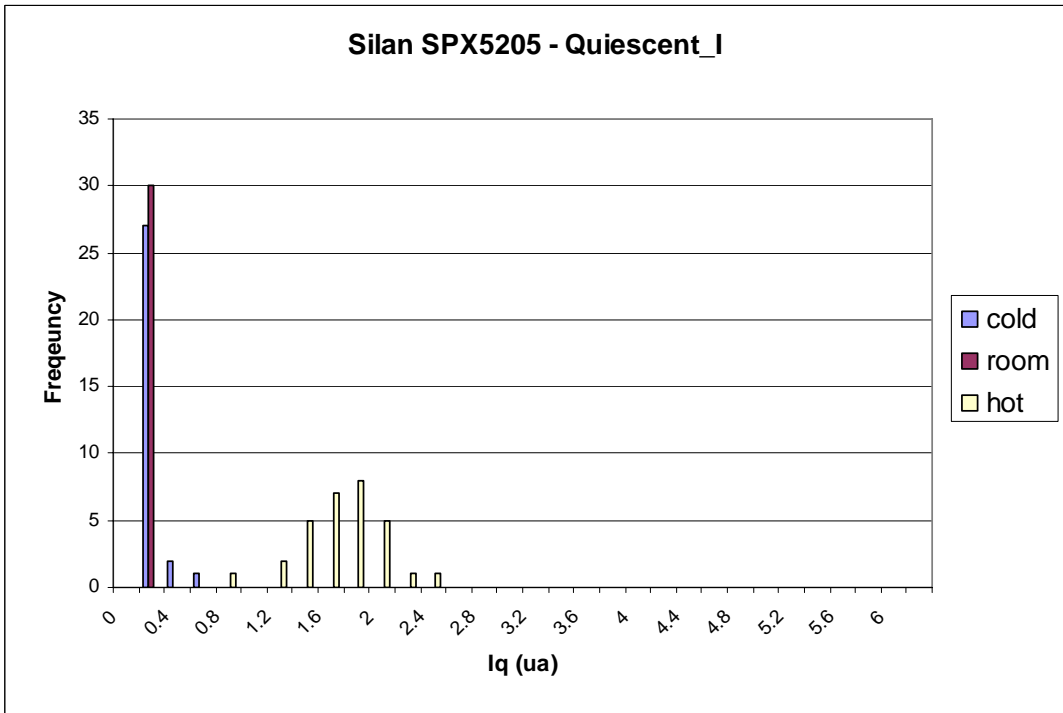
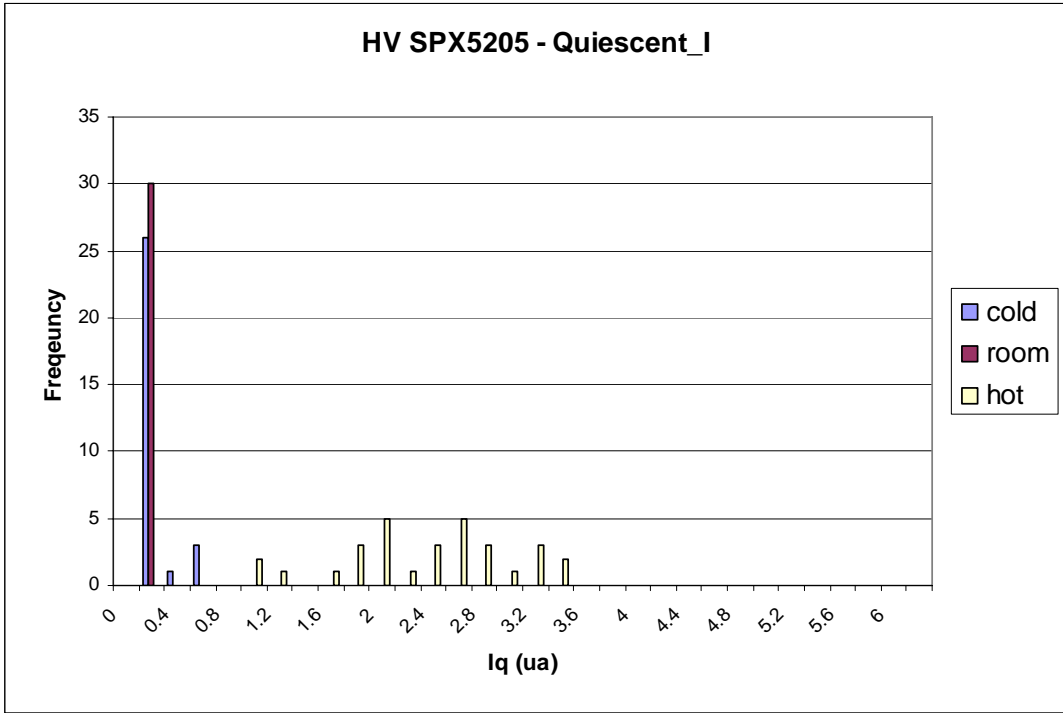

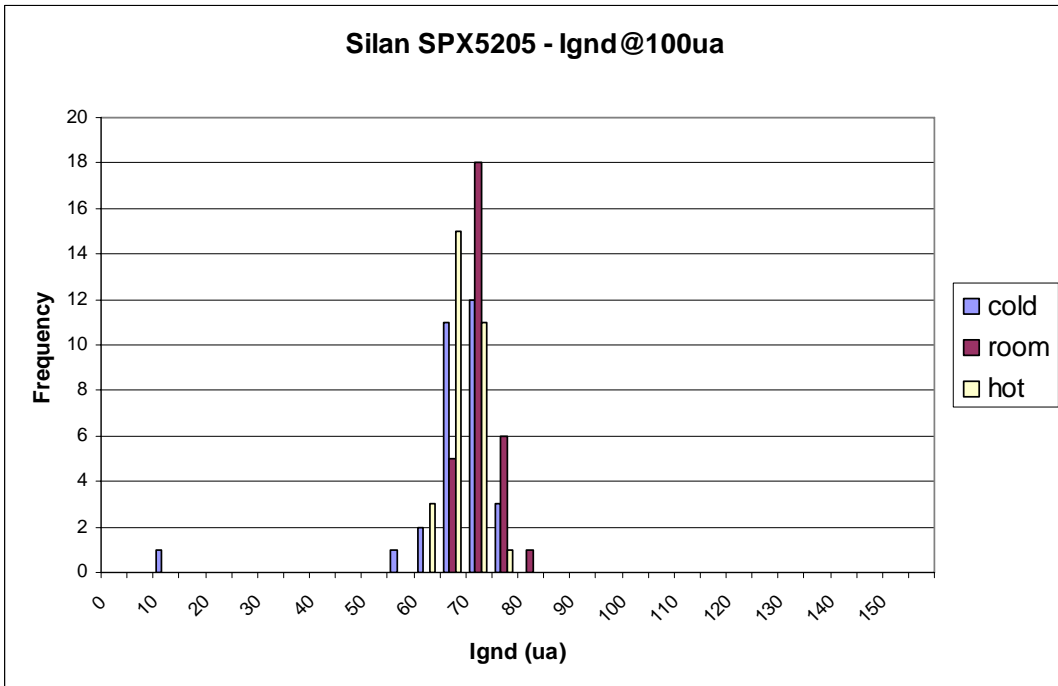
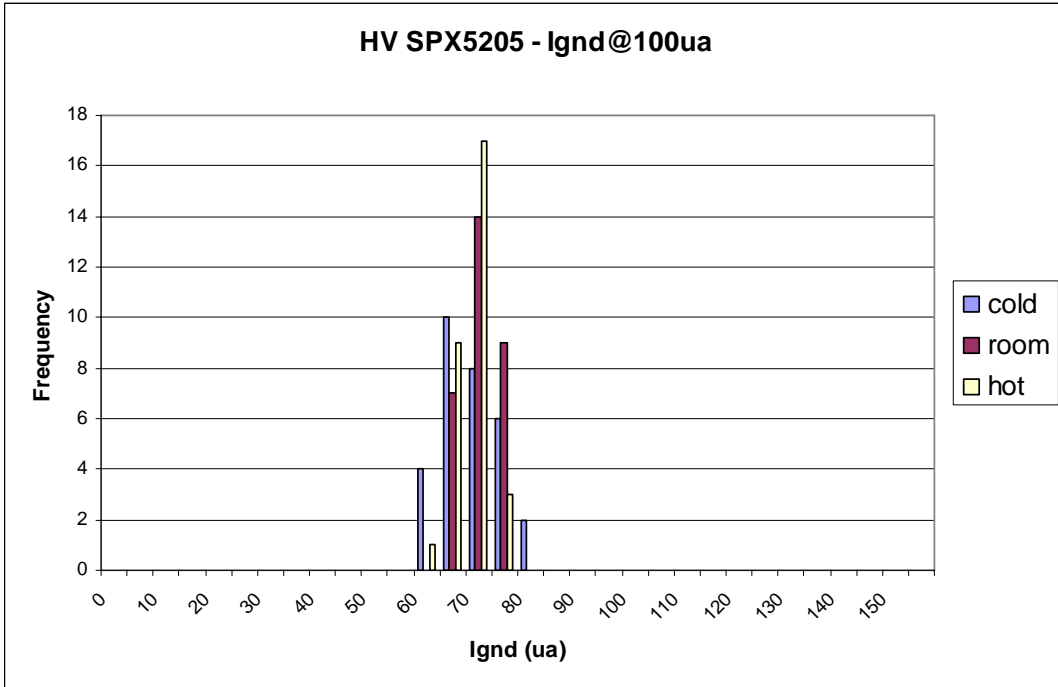

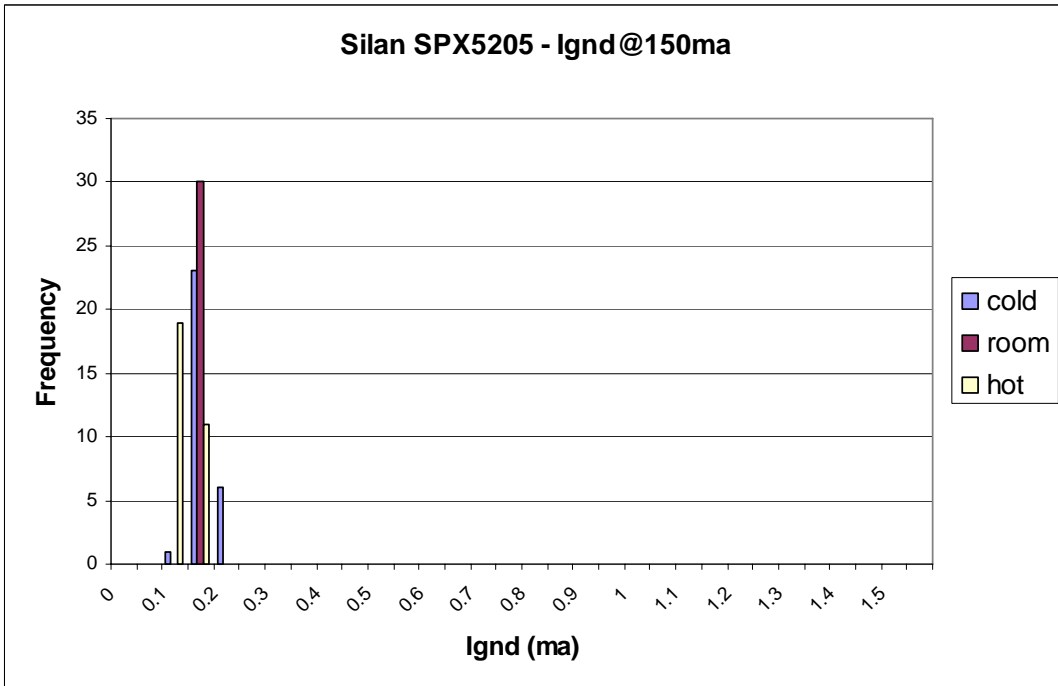
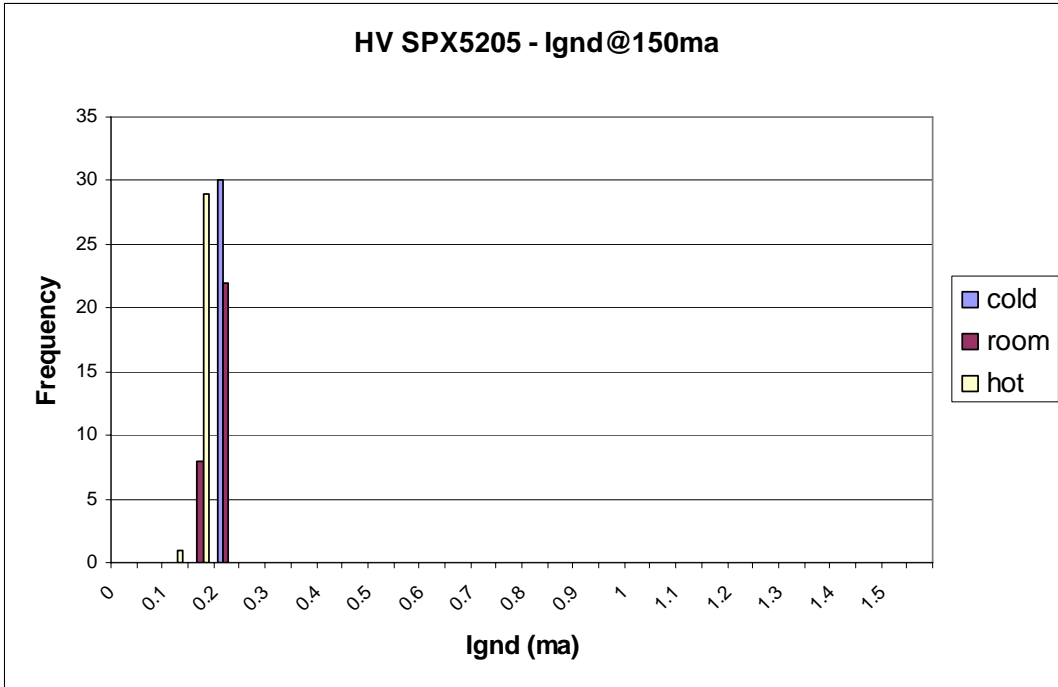

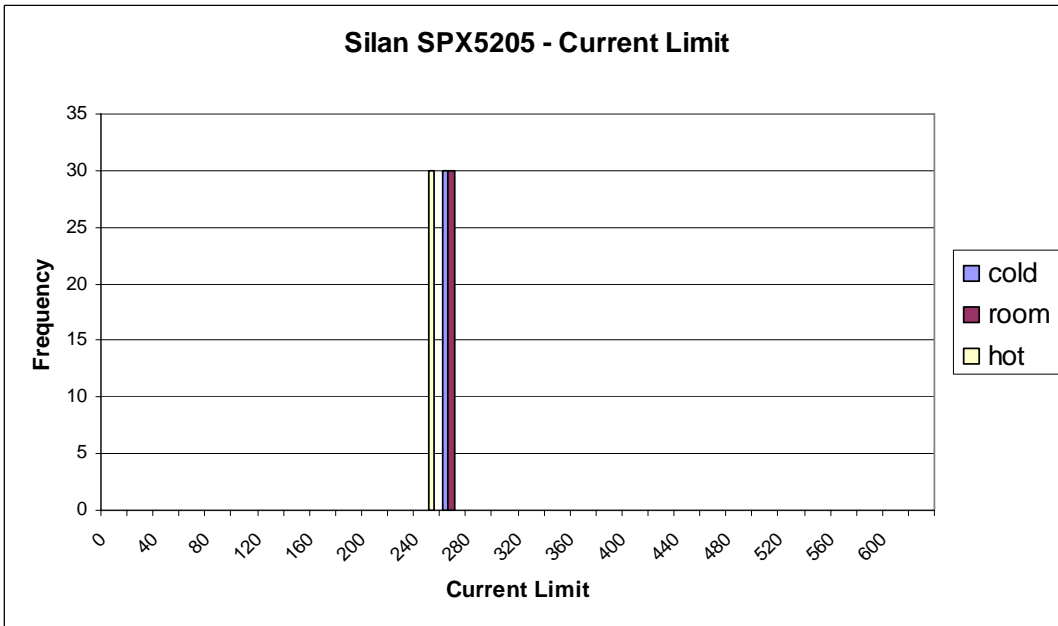
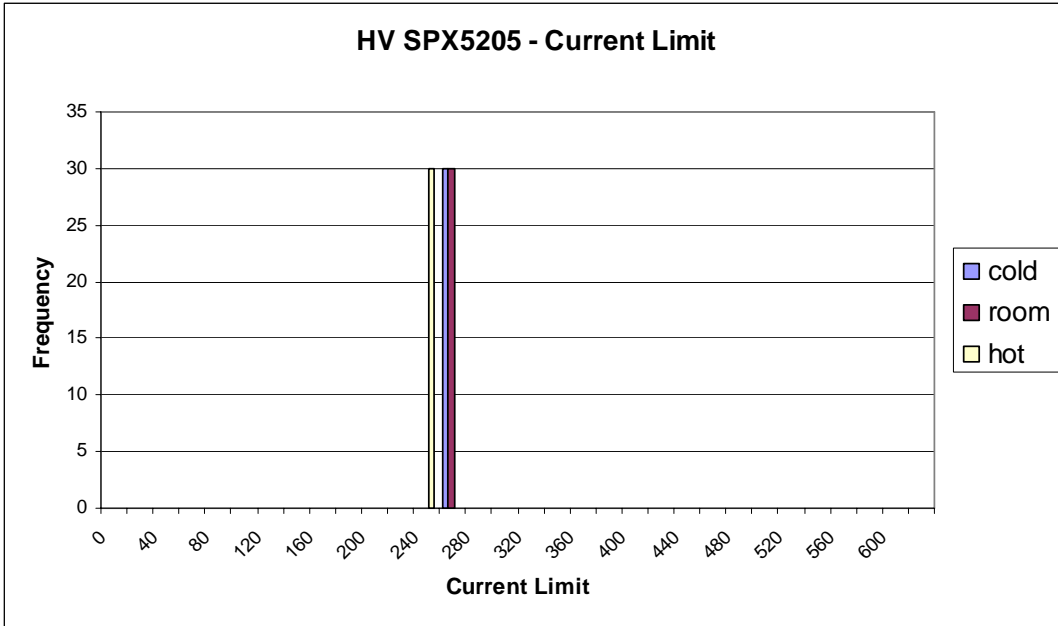



## Reliability and Qualification Report

# **Silan BP4 Process Reliability Qualification using the SPX29150**

Prepared By: Salvador Wu & Greg West  
QA Engineering  
Date: September 15, 2006

Reviewed By: Fred Claussen  
VP Quality & Reliability  
Date: September 15, 2006

**Table Of Contents**

Title Page	1
Table Of Contents	2
Device Description	2
Pin Out	2
Manufacturing Information	2
Package Information	2
Reliability Test Summary	3
Life Test Data	3
FIT Data Calculations	4
MTBF Data Calculations	4
ESD Testing	4
Early Life Failure Rate Testing	5
5L TO-263 Pb Free Package Qualification Addendum	4

**Device Description:**

The SPX29150/51/52/53 are 1.5A, highly accurate voltage regulators with a low dropout voltage of 390mV (typical) @ 1.5A. These regulators are specifically designed for low voltage applications that require a low dropout voltage and a fast transient response. They are fully fault protected against over-current, reverse battery, and positive and negative voltage transients. On-chip trimming adjusts the reference voltage to 1% initial accuracy. Other features in the 5 pin versions include Enable and Error Flag. The SPX29150/51/52/53 is offered in 3-pin and 5-pin TO-220 & TO-263 packages. For a 3A version, refer to the SPX29300 data sheet.

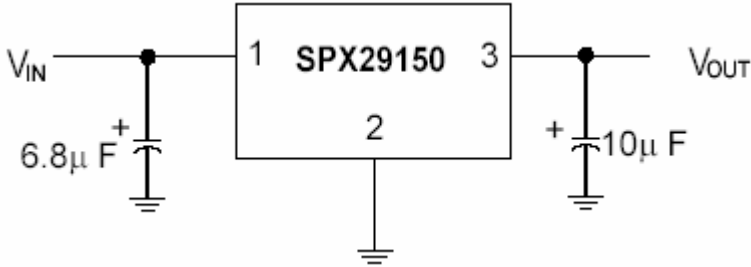
<p><b><u>Manufacturing Information:</u></b>          Product: SPX29150          Description: 1.5A PNP LDO          Mask Set: MS1562          Lot Number(s): SPXBP4012EC, A135428.3 (15), A136411.2 (16)          Process: sil-bp4          Wafer Fab: Silan</p> <p><b><u>Package Information:</u></b>          Package Type: TO 263-5L          Package Code:: JEDEC</p>	<p style="text-align: center;"><b>PIN OUT SPX29150</b></p> 
--	---



## **Reliability Qualification Test Summary:**

Stress Level	Device	Lot Number	Burn-In Temp	Sample Size	No. Fail
168Hrs	SPX29150	SPXBP401 2EC	125 °C	77	0
168Hrs	SPX29150	A135428.3 (15)	125 °C	77	0
168Hrs	SPX29150	A136411.2 (16)	125 °C	77	0
1000Hrs	SPX29150	SPXBP401 2EC	125 °C	77	0
1000Hrs	SPX29150	A135428.3 (15)	125 °C	77	0
1000Hrs	SPX29150	A136411.2 (16)	125 °C	77	0

### **Life Test**

Life testing is conducted to determine if there are any fundamental reliability related failure mechanism(s) present in the device.

These failure mechanisms can be divided roughly into four groups:

1. Process or die related failures such as oxide defects, metallization defects, and diffusion defects.
2. Assembly related failures such as chip mount defects, wire bond defects, molding defects, and trim/form/singulation defects.
3. Design related defects.
4. Miscellaneous, undetermined, or application induced failures.

### **125C Operating Life Test Results**

As part of the Sipex design qualification program, the Product/Reliability Engineering group subjected 231 parts to 168 hours and 1000 hours of 125° C life stress testing.

#### ***168 Hour Timepoint***

The 231 parts were subjected to the life test profile and completed the stress with no failures.

#### ***1000 Hour Timepoint***

231 parts were reintroduced to life stress testing, completing the 1000 hour HTOL time point without any failures or significant shifts in process parameters

### **FIT Rate Calculations**

FIT rate (failures in time) is the predicted number of failures per billion device hours.

This predicted value is based upon,



- The Life Test conditions summarized in the HTOL table (time/temperature, device quantity, failure quantity).
- The Activation Energy ( $E_a$ ) for potential failure modes. The weighted Activation Energy ( $E_a$ ) of observed failure mechanisms for Sipex products has been determined to be 0.8eV.

Based on the above criteria SPX29150 product FIT rates for 25°, 55°, and 70°C of operation at 60% and 90% confidence levels have been calculated and listed below.

**FIT Failure Rates: SPX29150 BP4 Silan Process**

Confidence Level	+25°C	+55°C	+70°C
60%	1.6	26.4	89.0
90%	3.9	64.2	216.0

1 FIT = 1 Failure per Billion Device-Hours

**MTBF Calculation: SPX29150 BP4 Silan Process**

Confidence Level	+25°C	+55°C	+70°C
60%	6.15E+08	3.78E+07	1.12E+07
90%	2.53E+08	1.56E+07	4.63E+06

**ESD Testing**

Human Body Model ESD – 32 units were subjected to Human Body Model ESD testing at +/- 2KV. All units passed.

**Early Life Failure Rate Testing**

Early Life Test – 600 units were subject to Early Life test for 48 Hours. All units passed

**Additional Reliability Tests**

77 of the units were placed on Unbiased HAST testing, 77 of the units were placed on Thermal Shock testing, and 77 on -65C/+150C Temperature Cycle testing. All units passed testing as summarized in the following table.

Test	Condition	Time	Sample Size	# of rejects
TEMP. Cycles	-65C/+150C	500 Cycles	77	0
HAST Unbiased	130C/85%RH	96hrs	77	0
Thermal Shock	-65C/+150C	500 Cycles	77	0