

August 1991

Features

- 8.0A and 9.0A, 150V - 200V
- $r_{DS(on)} = 0.4\Omega$ and 0.6Ω
- Single Pulse Avalanche Energy Rated*
- SOA is Power-Dissipation Limited
- Nanosecond Switching Speeds
- Linear Transfer Characteristics
- High Input Impedance

Description

The IRF630, IRF631, IRF632, and IRF633 are n-channel enhancement-mode silicon-gate power field-effect transistors. IRF630R, IRF631R, IRF632R and IRF633R types are advanced power MOSFETs designed, tested, and guaranteed to withstand a specified level of energy in the breakdown avalanche mode of operation. All of these power MOSFETs are designed for applications such as switching regulators, switching converters, motor drivers, relay drivers, and drivers for high-power bipolar switching transistors requiring high speed and low gate-drive power. These types can be operated directly from integrated circuits.

The IRF types are supplied in the JEDEC TO-220AB plastic package.

Package

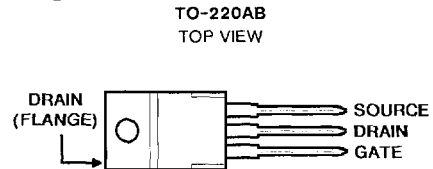

Terminal Diagram

N-CHANNEL ENHANCEMENT MODE

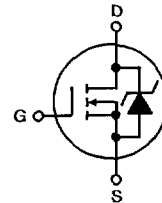

Absolute Maximum Ratings ($T_C = +25^\circ\text{C}$), Unless Otherwise Specified

	IRF630 IRF630R	IRF631 IRF631R	IRF632 IRF632R	IRF633 IRF633R	UNITS	
Drain-Source Voltage (1)	V_{DS}	200	150	200	150	V
Drain-Gate Voltage ($R_{GS} = 20k\Omega$) (1)	V_{DGR}	200	150	200	150	V
Continuous Drain Current						
$T_C = +25^\circ\text{C}$	I_D	9.0	9.0	8.0	8.0	A
$T_C = +100^\circ\text{C}$	I_D	6.0	6.0	5.0	5.0	A
Pulsed Drain Current (3)	I_{DM}	36	36	32	32	A
Gate-Source Voltage	V_{GS}	± 20	± 20	± 20	± 20	V
Maximum Power Dissipation						
$T_C = +25^\circ\text{C}$	P_D	75	75	75	75	W
Linear Derating Factor		0.6	0.6	0.6	0.6	W/ $^\circ\text{C}$
Inductive Current, Clamped	I_{LM}	36	36	32	32	A
(See Figure 14, $L = 100\mu\text{H}$)						
Single Pulse Avalanche Energy Rating (4)	E_{AS}^*	150	150	150	150	mJ
Operating and Storage Junction	T_J, T_{STG}	-55 to +150	-55 to +150	-55 to +150	-55 to +150	$^\circ\text{C}$
Temperature Range						
Maximum Lead Temperature for Soldering	T_L	300	300	300	300	$^\circ\text{C}$
(0.063" (1.6mm) from case for 10s)						

NOTES:

- $T_J = +25^\circ\text{C}$ to $+150^\circ\text{C}$.
 - Pulse Test: Pulse width $\leq 300\mu\text{s}$, Duty Cycle $\leq 2\%$.
 - Repetitive rating: Pulse width limited by maximum junction temperature. See Transient Thermal Impedance Curve (Figure 5).
 - $V_{DD} = 20\text{V}$, starting $T_J = +25^\circ\text{C}$, $L = 3.37\text{mH}$, $R_{GS} = 50\Omega$, $I_{PEAK} = 9\text{A}$. See Figure 15.
- *R Suffix Types Only

IRF630, IRF631, IRF632, IRF633 IRF630R, IRF631R, IRF632R, IRF633R

Electrical Characteristics $T_C = 25^\circ\text{C}$, Unless Otherwise Specified

CHARACTERISTIC	SYMBOL	TEST CONDITIONS	LIMITS			UNITS
			MIN	TYP	MAX	
Drain-Source Breakdown Voltage IRF630/632, IRF630R/632R IRF631/633, IRF631R/633R	BV_{DSS}	$V_{GS} = 0V, I_D = 250\mu A$	200	-	-	V
			150	-	-	V
Gate Threshold Voltage	$V_{GS(TH)}$	$V_{DS} = V_{GS}, I_D = 250\mu A$	2.0	-	4.0	V
Gate-Source Leakage Forward	I_{GSS}	$V_{GS} = 20V$	-	-	500	nA
Gate-Source Leakage Reverse	I_{GSS}	$V_{GS} = -20V$	-	-	-500	nA
Zero Gate Voltage Drain Current	I_{DSS}	$V_{DS} = \text{Max Rating}, V_{GS} = 0V$ $V_{DS} = \text{Max Rating} \times 0.8, V_{GS} = 0V,$ $T_J = +125^\circ\text{C}$	-	-	250	μA
			-	-	1000	μA
On-State Drain Current (Note 2) IRF630/631, IRF630R/631R IRF632/633, IRF632R/633R	$I_{D(ON)}$	$V_{DS} > I_{D(ON)} \times r_{DS(ON) \text{ Max}}, V_{GS} = 10V$	9.0	-	-	A
			8.0	-	-	A
Static Drain-Source On-State Resistance (Note 2) IRF630/631, IRF630R/631R IRF632/633, IRF632R/633R	$r_{DS(ON)}$	$V_{GS} = 10V, I_D = 5.0A$	-	0.25	0.4	Ω
			-	0.4	0.6	Ω
Forward Transconductance (Note 2)	g_{fs}	$V_{DS} > I_{D(ON)} \times r_{DS(ON) \text{ Max}}, I_D = 5.0A$	3.0	4.8	-	S(\bar{I})
Input Capacitance	C_{ISS}	$V_{GS} = 0V, V_{DS} = 25V, f = 1.0\text{MHz}$ See Figure 10	-	600	-	pF
Output Capacitance	C_{OSS}		-	250	-	pF
Reverse Transfer Capacitance	C_{RSS}		-	80	-	pF
Turn-On Delay Time	$t_{d(ON)}$		$V_{DD} = 90V, I_D = 9.0A, R_G = 9.1\Omega$ See Figure 16. (MOSFET switching times are essentially independent of operating temperature)	-	-	30
Rise Time	t_r		-	-	50	ns
Turn-Off Delay Time	$t_{d(OFF)}$		-	-	50	ns
Fall Time	t_f		-	-	40	ns
Total Gate Charge (Gate-Source + Gate-Drain)	Q_g		$V_{GS} = 10V, I_D = 9.0A, V_{DS} = 0.8V \text{ Max Rating. See Figure 17 for test circuit. (Gate charge is essentially independent of operating temperature.)}$	-	19	30
Gate-Source Charge	Q_{gs}	-		10	-	nC
Gate-Drain ("Miller") Charge	Q_{gd}	-		9.0	-	nC
Internal Drain Inductance	L_D	Measured from the contact screw on tab to center of die	-	3.5	-	nH
		Measured from the drain lead, 6mm (0.25in.) from package to center of die	-	4.5	-	nH
Internal Source Inductance	L_S	Measured from the source lead, 6mm (0.25in.) from header and source bonding pad.	-	7.5	-	nH
Junction-to-Case	$R_{\theta JC}$		-	-	1.67	$^\circ\text{C/W}$
Case-to-Sink	$R_{\theta CS}$	Mounting surface flat, smooth and greased	-	0.5	-	$^\circ\text{C/W}$
Junction-to-Ambient	$R_{\theta JA}$	Free air operation	-	-	80	$^\circ\text{C/W}$

4
N-CHANNEL
POWER MOSFETS

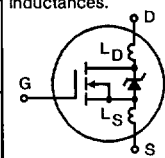

Source Drain Diode Ratings and Characteristics

Continuous Source Current (Body Diode)	I_S	Modified MOSFET symbol showing the integral reverse P-N junction rectifier.	-	-	9.0	A
Pulse Source Current (Body Diode) (Note 3)	I_{SM}		-	-	36	A
Diode Forward Voltage (Note 2)	V_{SD}	$T_J = +25^\circ\text{C}, I_S = 9.0A, V_{GS} = 0V$	-	-	2.0	V
Reverse Recovery Time	t_{rr}	$T_J = +150^\circ\text{C}, I_F = 9.0A, dI_F/dt = 100A/\mu s$	-	450	-	ns
Reverse Recovered Charge	Q_{RR}	$T_J = +150^\circ\text{C}, I_F = 9.0A, dI_F/dt = 100A/\mu s$	-	3.0	-	μC
Forward Turn-on Time	t_{ON}	Intrinsic turn-on time is negligible. Turn-on speed is substantially controlled by $L_S + L_D$.	-	-	-	-

NOTES: 1. $T_J = +25^\circ\text{C}$ to $+150^\circ\text{C}$.
 2. Pulse Test: Pulse width $\leq 300\mu s$, Duty Cycle $\leq 2\%$.
 3. Repetitive Rating: Pulse width limited by max. junction temperature. See Transient Thermal Impedance Curve (Figure 5).
 4. $V_{DD} = 20V$, Start $T_J = +25^\circ\text{C}$, $L = 3.37\text{mH}$, $R_{GS} = 50\Omega$, $I_{PEAK} = 9A$ (See Figure 15)

IRF630, IRF631, IRF632, IRF633 IRF630R, IRF631R, IRF632R, IRF633R

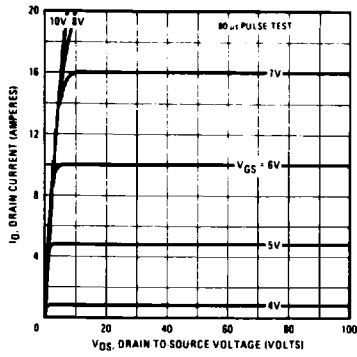

Fig. 1 - Typical Output Characteristics

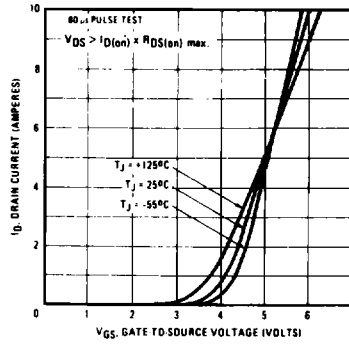

Fig. 2 - Typical Transfer Characteristics

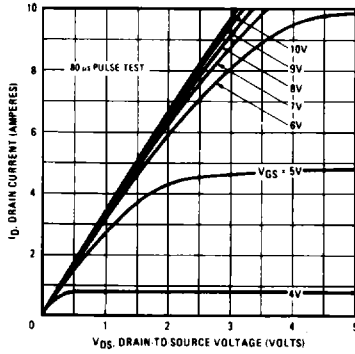

Fig. 3 - Typical Saturation Characteristics

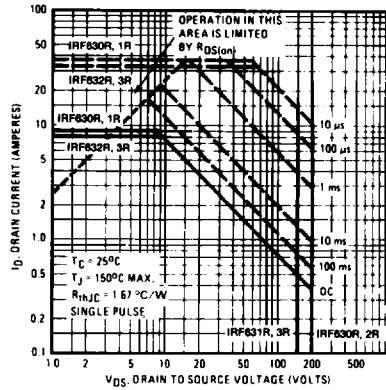

Fig. 4 - Maximum Safe Operating Area

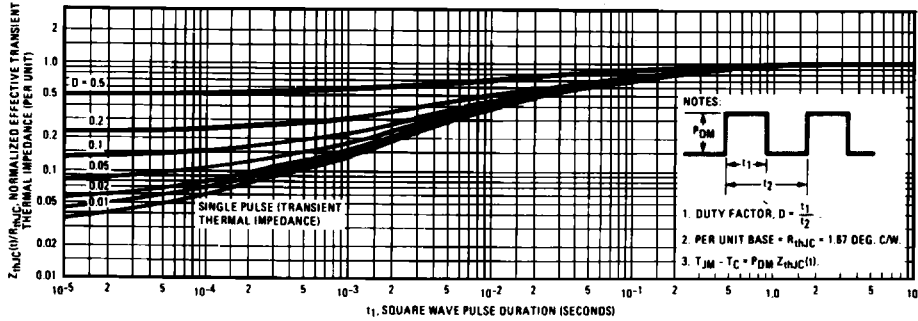

Fig. 5 - Maximum Effective Transient Thermal Impedance, Junction-to-Case Vs. Pulse Duration

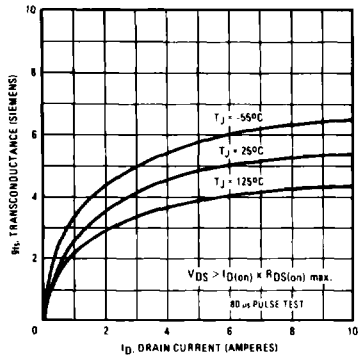

Fig. 6 - Typical Transconductance Vs. Drain Current

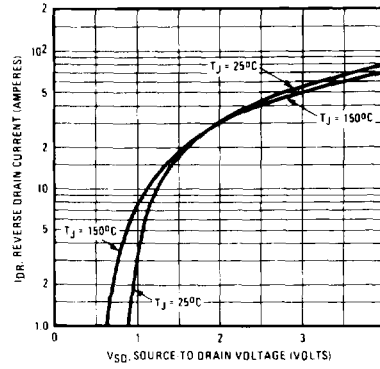

Fig. 7 - Typical Source-Drain Diode Forward Voltage

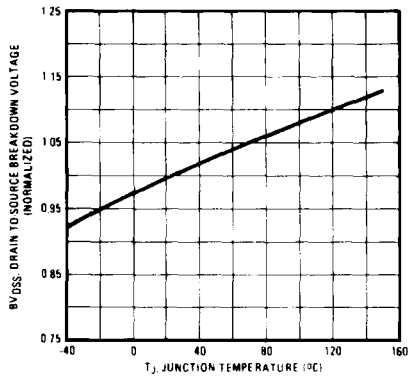

Fig. 8 - Breakdown Voltage Vs. Temperature

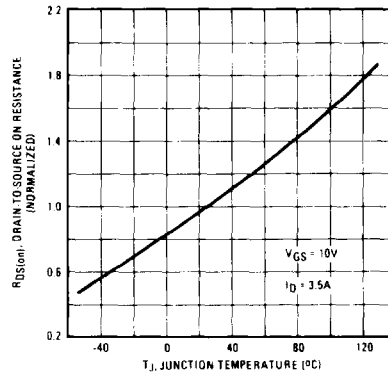

Fig. 9 - Normalized On-Resistance Vs. Temperature

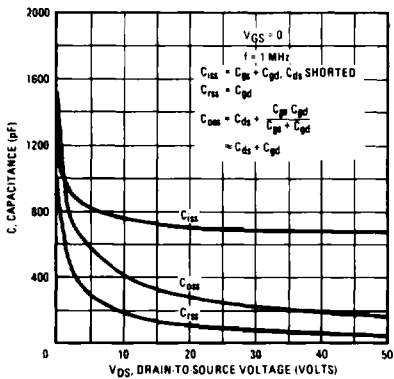

Fig. 10 - Typical Capacitance Vs. Drain-to-Source Voltage

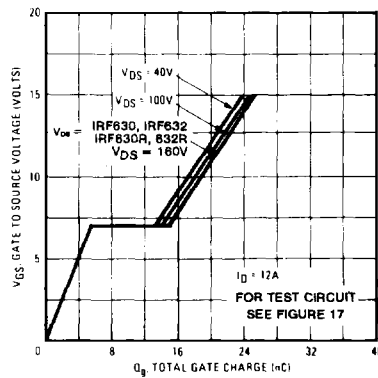

Fig. 11 - Typical Gate Charge Vs. Gate-to-Source Voltage

IRF630, IRF631, IRF632, IRF633 IRF630R, IRF631R, IRF632R, IRF633R

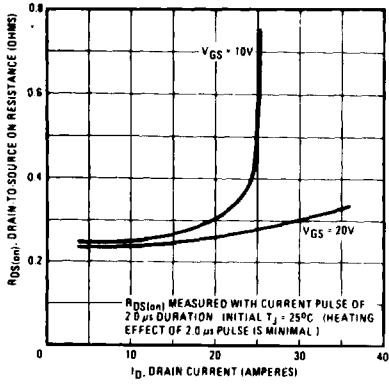

Fig. 12 — Typical On-Resistance Vs. Drain Current

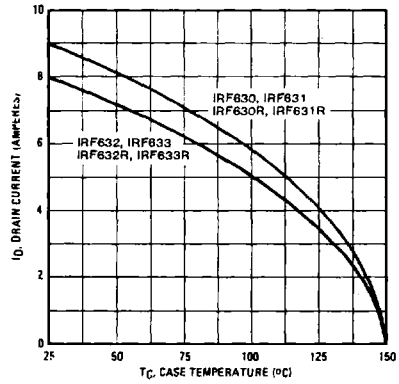

Fig. 13 — Maximum Drain Current Vs. Case Temperature

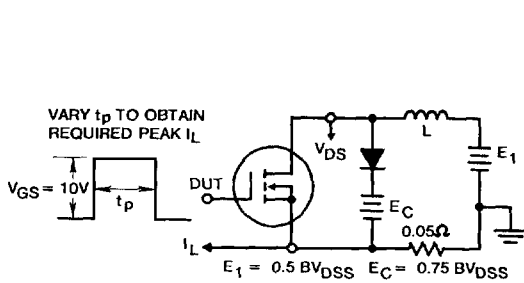

Fig. 14a — Clamped Inductive Test Circuit

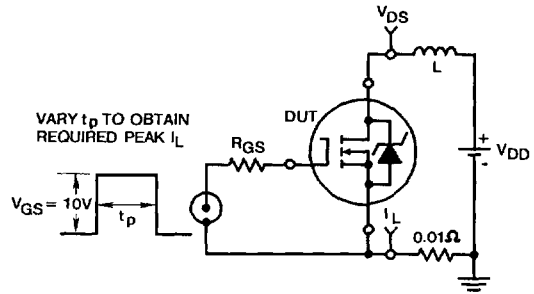

Fig. 15a — Unclamped Energy Test Circuit

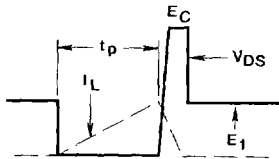

Fig. 14b — Clamped Inductive Waveforms

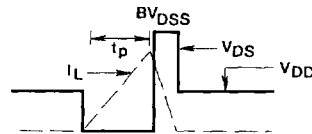

Fig. 15b — Unclamped Energy Waveforms

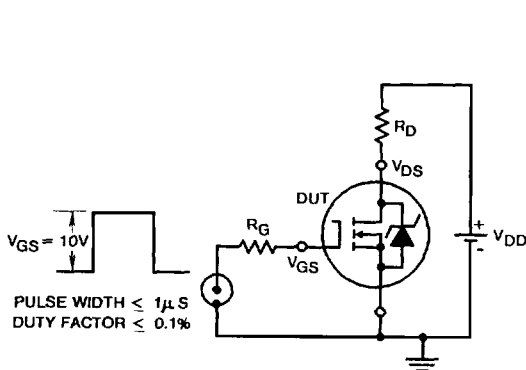

Fig. 16 — Switching Time Test Circuit

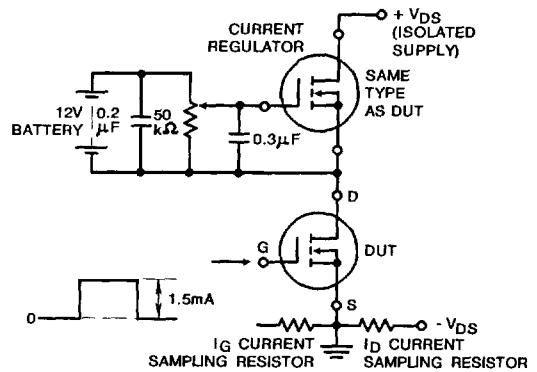

Fig. 17 — Gate Charge Test Circuit