

**GLASS PASSIVATED RECTIFIER**

**VOLTAGE RANGE 50 to 1000 Volts CURRENT 3.0 Amperes**

**FEATURES**

- \* Low cost
- \* Low leakage
- \* Low forward voltage drop
- \* High current capability

**MECHANICAL DATA**

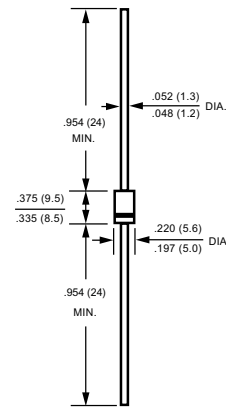
- \* Case: Molded plastic
- \* Epoxy: Device has UL flammability classification 94V-0
- \* Lead: MIL-STD-202E method 208C guaranteed
- \* Mounting position: Any
- \* Weight: 1.2 grams

**MAXIMUM RATINGS AND ELECTRICAL CHARACTERISTICS**

Ratings at 25 °C ambient temperature unless otherwise specified.  
Single phase, half wave, 60 Hz, resistive or inductive load.  
For capacitive load, derate current by 20%.



**DO-201AD**



**MAXIMUM RATINGS (@ TA=25 °C unless otherwise noted)**

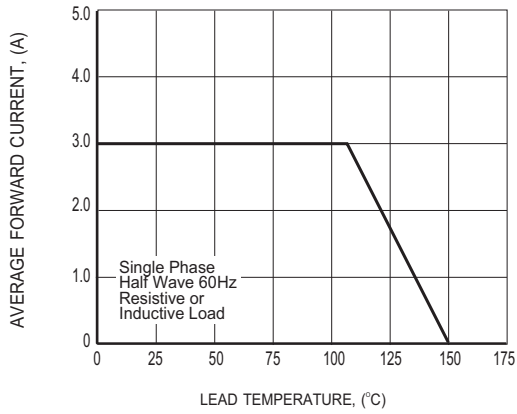
RATINGS	SYMBOL	1N5400G	1N5401G	1N5402G	1N5404G	1N5406G	1N5407G	1N5408G	UNITS
Maximum Recurrent Peak Reverse Voltage	V <sub>RRM</sub>	50	100	200	400	600	800	1000	Volts
Maximum RMS Voltage	V <sub>RMS</sub>	35	70	140	280	420	560	700	Volts
Maximum DC Blocking Voltage	V <sub>DC</sub>	50	100	200	400	600	800	1000	Volts
Maximum Average Forward Rectified Current at T <sub>L</sub> = 105 °C	I <sub>O</sub>	3.0							Amps
Peak Forward Surge Current 8.3 ms single half sine-wave superimposed on rated load (JEDEC method)	I <sub>FSM</sub>	200							Amps
Typical Current Squared Time	i <sup>2</sup> T	166							A <sup>2</sup> S
Typical Thermal Resistance(Note2)	R <sub>θJA</sub>	20							°C/W
	R <sub>θJL</sub>	5.0							
Typical Junction Capacitance(Note1)	C <sub>J</sub>	30							pF
Operating and Storage Temperature Range	T <sub>J</sub> , T <sub>STG</sub>	-55 to + 150							°C

**ELECTRICAL CHARACTERISTICS (@TA=25 °C unless otherwise noted)**

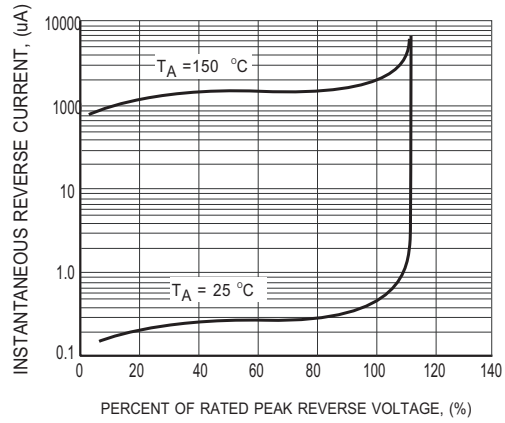
CHARACTERISTICS	SYMBOL	1N5400G	1N5401G	1N5402G	1N5404G	1N5406G	1N5407G	1N5408G	UNITS
Maximum Instantaneous Forward Voltage at 3.0A DC	V <sub>F</sub>	.98							Volts
Maximum DC Reverse Current at Rated DC Blocking Voltage	@T <sub>A</sub> = 25 °C	0.5							uAmps
	@T <sub>A</sub> = 150 °C	2							mAmps

NOTES : 1. Measured at 1 MHz and applied reverse voltage of 4.0 volts.  
2. Typical Thermal Resistance : At 9.5mm lead lengths, PCB mounted.

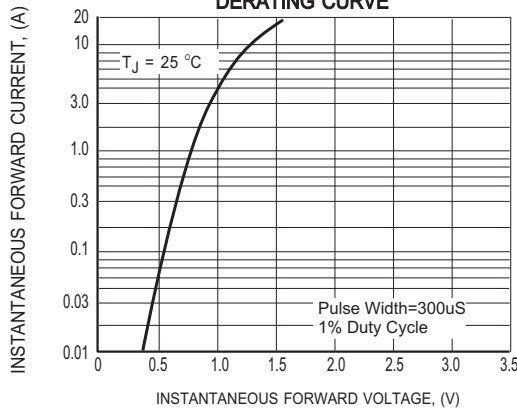
# RATING AND CHARACTERISTICS CURVES ( 1N5400G THRU 1N5408G)



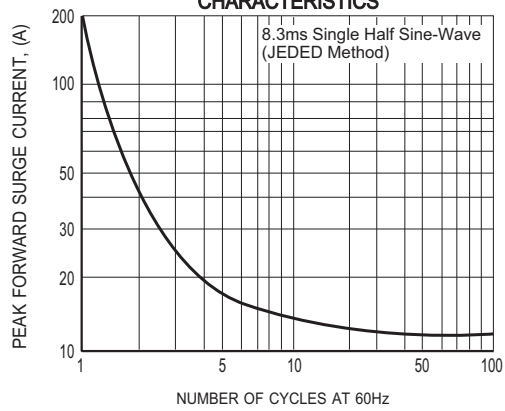
**FIG.1 TYPICAL FORWARD CURRENT DERATING CURVE**



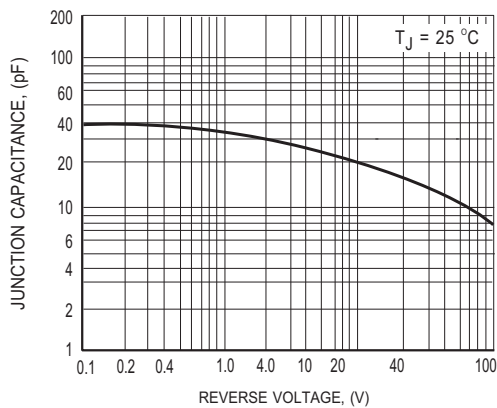
**FIG.2 MAXIMUM REVERSE CHARACTERISTICS**



**FIG.3 MAXIMUM INSTANTANEOUS FORWARD CHARACTERISTICS**

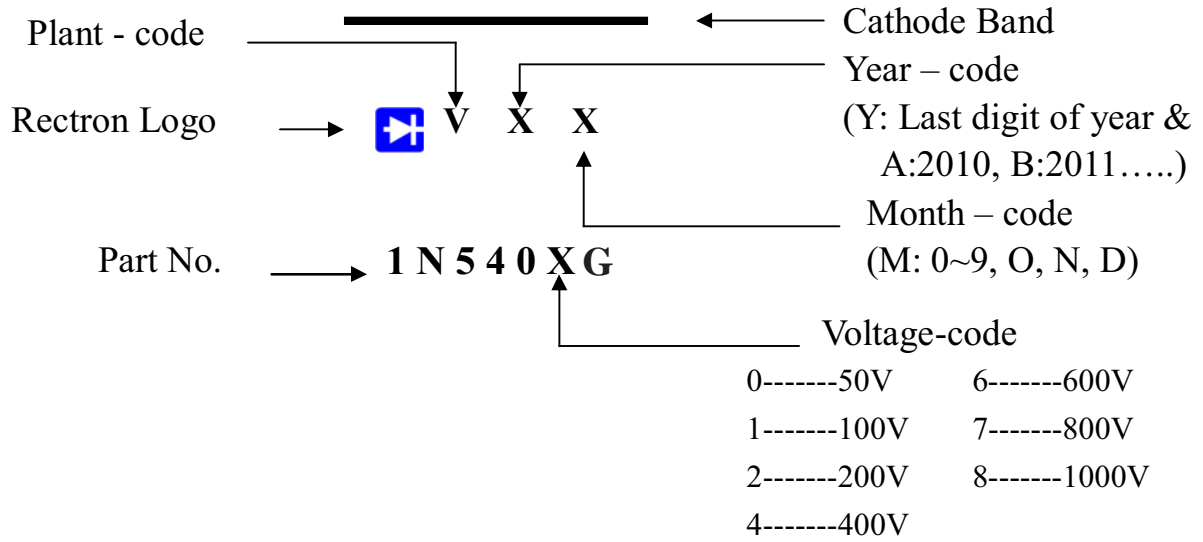


**FIG.4 MAXIMUM NON-REPETITIVE FORWARD SURGE CURRENT**



**FIG.5 TYPICAL JUNCTION CAPACITANCE**

# Marking Description



## PACKAGING OF DIODE AND BRIDGE RECTIFIERS

### BULK PACK

PACKAGE	PACKING CODE	EA PER BOX	INNER BOX SIZE (mm)	CARTON SIZE (mm)	EA PER CARTON	GROSS WEIGHT(Kg)
DO-201	-B	500	300*73*40	347*320*271	12,000	15.9

### REEL PACK

PACKAGE	PACKING CODE	EA PER REEL	EA PER INNER BOX	COMPONENT SPACE (mm)	TAPE SPACE (mm)	REEL DIA (mm)	CARTON SIZE (mm)	EA PER CARTON	GROSS WEIGHT(Kg)
DO-201	-T	1,200	1,200	5.0	52	330	355*350*335	4,800	9.10

### AMMO PACK

PACKAGE	PACKING CODE	REEL ( EA )	COMPONENT SPACE(mm)	TAPE SPACE (mm)	BOX SIZE (mm)	CARTON SIZE(mm)	CARTON ( EA )	GROSS WEIGHT (Kg)
DO-201	-F	600	9.5	52	255*73*100	400*268*225	6,000	9.9

## DISCLAIMER NOTICE

Rectron Inc reserves the right to make changes without notice to any product specification herein, to make corrections, modifications, enhancements or other changes. Rectron Inc or anyone on its behalf assumes no responsibility or liability for any errors or inaccuracies. Data sheet specifications and its information contained are intended to provide a product description only. "Typical" parameters which may be included on RECTRON data sheets and/ or specifications can and do vary in different applications and actual performance may vary over time. Rectron Inc does not assume any liability arising out of the application or use of any product or circuit.

Rectron products are not designed, intended or authorized for use in medical, life-saving implant or other applications intended for life-sustaining or other related applications where a failure or malfunction of component or circuitry may directly or indirectly cause injury or threaten a life without expressed written approval of Rectron Inc. Customers using or selling Rectron components for use in such applications do so at their own risk and shall agree to fully indemnify Rectron Inc and its subsidiaries harmless against all claims, damages and expenditures.