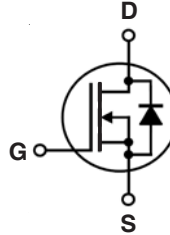
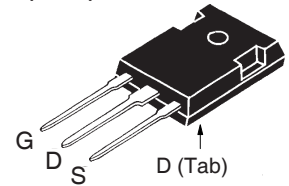
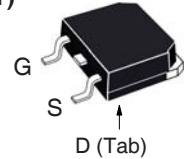

**Depletion Mode
MOSFET**
**IXTH10N100D2
IXTT10N100D2**

$$V_{DSX} = 1000V$$

$$I_{D(on)} \geq 10A$$

$$R_{DS(on)} \leq 1.5\Omega$$

N-Channel

TO-247 (IXTH)

TO-268 (IXTT)

G = Gate D = Drain
S = Source Tab = Drain

| Symbol | Test Conditions | Maximum Ratings | |
|------------|---|-----------------|------------------|
| V_{DSX} | $T_J = 25^\circ\text{C to } 150^\circ\text{C}$ | 1000 | V |
| V_{DGX} | $T_J = 25^\circ\text{C to } 150^\circ\text{C}, R_{GS} = 1M\Omega$ | 1000 | V |
| V_{GSX} | Continuous | ± 20 | V |
| V_{GSM} | Transient | ± 30 | V |
| P_D | $T_C = 25^\circ\text{C}$ | 695 | W |
| T_J | | - 55 ... +150 | $^\circ\text{C}$ |
| T_{JM} | | 150 | $^\circ\text{C}$ |
| T_{stg} | | - 55 ... +150 | $^\circ\text{C}$ |
| T_L | Maximum Lead Temperature for Soldering | 300 | $^\circ\text{C}$ |
| T_{SOLD} | 1.6 mm (0.062in.) from Case for 10s | 260 | $^\circ\text{C}$ |
| M_d | Mounting Torque (TO-247) | 1.13 / 10 | Nm/lb.in. |
| Weight | TO-247 | 6 | g |
| | TO-268 | 4 | g |

| Symbol | Test Conditions ($T_J = 25^\circ\text{C}$, Unless Otherwise Specified) | Characteristic Values | | |
|----------------|---|-----------------------|------|---------------------------------------|
| | | Min. | Typ. | Max. |
| BV_{DSX} | $V_{GS} = -5V, I_D = 250\mu\text{A}$ | 1000 | | V |
| $V_{GS(off)}$ | $V_{DS} = 25V, I_D = 1\text{mA}$ | - 2.5 | | V |
| I_{GSX} | $V_{GS} = \pm 20V, V_{DS} = 0V$ | | | ± 100 nA |
| $I_{DSX(off)}$ | $V_{DS} = V_{DSX}, V_{GS} = -5V$ $T_J = 125^\circ\text{C}$ | | | 10 μA 250 μA |
| $R_{DS(on)}$ | $V_{GS} = 0V, I_D = 5A, \text{ Note 1}$ | | | 1.5 Ω |
| $I_{D(on)}$ | $V_{GS} = 0V, V_{DS} = 25V, \text{ Note 1}$ | 10 | | A |

Features

- Normally ON Mode
- International Standard Packages
- Molding Epoxies Meet UL94V-0 Flammability Classification

Advantages

- Easy to Mount
- Space Savings
- High Power Density

Applications

- Audio Amplifiers
- Start-up Circuits
- Protection Circuits
- Ramp Generators
- Current Regulators
- Active Loads

| Symbol | Test Conditions ($T_J = 25^\circ\text{C}$, Unless Otherwise Specified) | Characteristic Values | | |
|--------------|---|-----------------------|------|-------------------------|
| | | Min. | Typ. | Max. |
| g_{fs} | $V_{DS} = 30\text{V}$, $I_D = 5\text{A}$, Note 1 | 11 | 17 | S |
| C_{iss} | $V_{GS} = -10\text{V}$, $V_{DS} = 25\text{V}$, $f = 1\text{MHz}$ | | 5320 | pF |
| C_{oss} | | | 300 | pF |
| C_{rss} | | | 70 | pF |
| $t_{d(on)}$ | Resistive Switching Times $V_{GS} = \pm 5\text{V}$, $V_{DS} = 500\text{V}$, $I_D = 5\text{A}$ $R_G = 3.3\Omega$ (External) | | 33 | ns |
| t_r | | | 36 | ns |
| $t_{d(off)}$ | | | 33 | ns |
| t_f | | | 164 | ns |
| $Q_{g(on)}$ | $V_{GS} = \pm 5\text{V}$, $V_{DS} = 500\text{V}$, $I_D = 5\text{A}$ | | 200 | nC |
| Q_{gs} | | | 19 | nC |
| Q_{gd} | | | 98 | nC |
| R_{thJC} | TO-247 | | | 0.18 $^\circ\text{C/W}$ |
| R_{thCS} | | | 0.21 | $^\circ\text{C/W}$ |

Safe-Operating-Area Specification

| Symbol | Test Conditions | Characteristic Values | | |
|--------|--|-----------------------|------|------|
| | | Min. | Typ. | Max. |
| SOA | $V_{DS} = 800\text{V}$, $I_D = 0.22\text{A}$, $T_C = 75^\circ\text{C}$, $t_p = 5\text{s}$ | 176 | | W |

Source-Drain Diode

| Symbol | Test Conditions ($T_J = 25^\circ\text{C}$, Unless Otherwise Specified) | Characteristic Values | | |
|----------|--|-----------------------|------|---------------|
| | | Min. | Typ. | Max. |
| V_{SD} | $I_F = 10\text{A}$, $V_{GS} = -10\text{V}$, Note 1 | | 0.8 | 1.3 V |
| t_{rr} | $I_F = 5\text{A}$, $-di/dt = 100\text{A}/\mu\text{s}$ $V_R = 100\text{V}$, $V_{GS} = -10\text{V}$ | | 1.2 | μs |
| I_{RM} | | | 23 | A |
| Q_{RM} | | | 13.8 | μC |

Note 1. Pulse test, $t \leq 300\mu\text{s}$, duty cycle, $d \leq 2\%$.

PRELIMINARY TECHNICAL INFORMATION

The product presented herein is under development. The Technical Specifications offered are derived from a subjective evaluation of the design, based upon prior knowledge and experience, and constitute a "considered reflection" of the anticipated result. IXYS reserves the right to change limits, test conditions, and dimensions without notice.

IXYS Reserves the Right to Change Limits, Test Conditions, and Dimensions.

IXYS MOSFETs and IGBTs are covered 4,835,592 4,931,844 5,049,961 5,237,481 6,162,665 6,404,065 B1 6,683,344 6,727,585 7,005,734 B2 7,157,338B2
by one or more of the following U.S. patents: 4,860,072 5,017,508 5,063,307 5,381,025 6,259,123 B1 6,534,343 6,710,405 B2 6,759,692 7,063,975 B2
4,881,106 5,034,796 5,187,117 5,486,715 6,306,728 B1 6,583,505 6,710,463 6,771,478 B2 7,071,537

TO-247 Outline

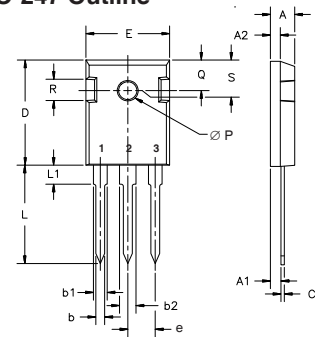

Terminals: 1 - Gate 2 - Drain
3 - Source

| Dim. | Millimeter | | Inches | |
|----------------|------------|-------|--------|-------|
| | Min. | Max. | Min. | Max. |
| A | 4.7 | 5.3 | .185 | .209 |
| A ₁ | 2.2 | 2.54 | .087 | .102 |
| A ₂ | 2.2 | 2.6 | .059 | .098 |
| b | 1.0 | 1.4 | .040 | .055 |
| b ₁ | 1.65 | 2.13 | .065 | .084 |
| b ₂ | 2.87 | 3.12 | .113 | .123 |
| C | .4 | .8 | .016 | .031 |
| D | 20.80 | 21.46 | .819 | .845 |
| E | 15.75 | 16.26 | .610 | .640 |
| e | 5.20 | 5.72 | 0.205 | 0.225 |
| L | 19.81 | 20.32 | .780 | .800 |
| L ₁ | | 4.50 | | .177 |
| ∅P | 3.55 | 3.65 | .140 | .144 |
| Q | 5.89 | 6.40 | 0.232 | 0.252 |
| R | 4.32 | 5.49 | .170 | .216 |
| S | 6.15 | BSC | 242 | BSC |

TO-268 Outline

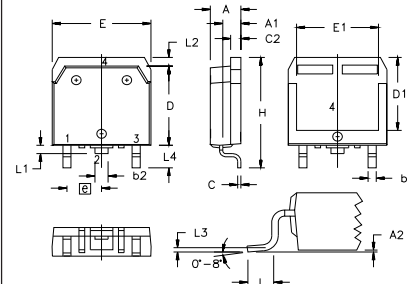

Terminals: 1 - Gate 2,4 - Drain
3 - Source

| SYM | INCHES | | MILLIMETERS | |
|----------------|--------|------|-------------|-------|
| | MIN | MAX | MIN | MAX |
| A | .193 | .201 | 4.90 | 5.10 |
| A ₁ | .106 | .114 | 2.70 | 2.90 |
| A ₂ | .001 | .010 | 0.02 | 0.25 |
| b | .045 | .057 | 1.15 | 1.45 |
| b ₂ | .075 | .083 | 1.90 | 2.10 |
| C | .016 | .026 | 0.40 | 0.65 |
| C ₂ | .057 | .063 | 1.45 | 1.60 |
| D | .543 | .551 | 13.80 | 14.00 |
| D ₁ | .488 | .500 | 12.40 | 12.70 |
| E | .624 | .632 | 15.85 | 16.05 |
| E ₁ | .524 | .535 | 13.30 | 13.60 |
| e | .215 | BSC | 5.45 | BSC |
| H | .736 | .752 | 18.70 | 19.10 |
| L | .094 | .106 | 2.40 | 2.70 |
| L ₁ | .047 | .055 | 1.20 | 1.40 |
| L ₂ | .039 | .045 | 1.00 | 1.15 |
| L ₃ | .010 | BSC | 0.25 | BSC |
| L ₄ | .150 | .161 | 3.80 | 4.10 |

Fig. 1. Output Characteristics @ $T_J = 25^\circ\text{C}$

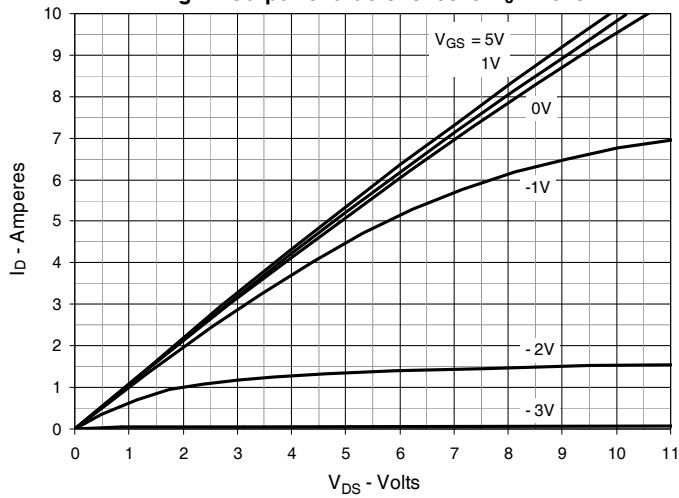

Fig. 2. Extended Output Characteristics @ $T_J = 25^\circ\text{C}$

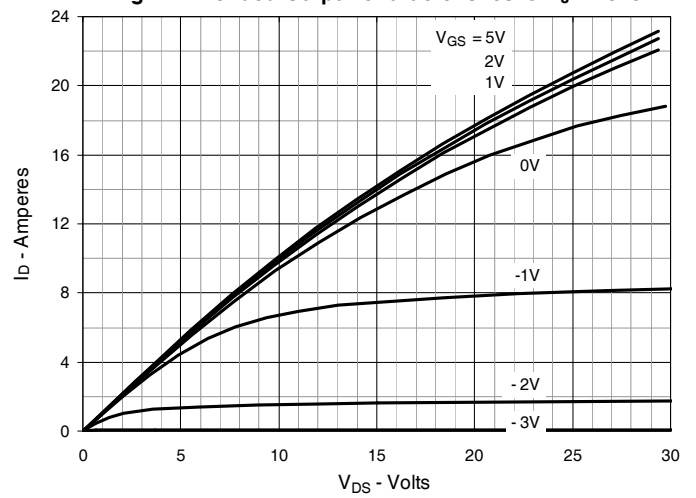

Fig. 3. Output Characteristics @ $T_J = 125^\circ\text{C}$

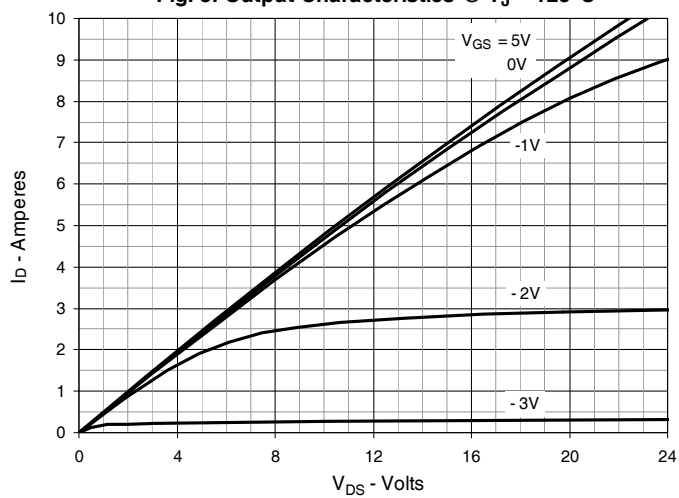

Fig. 4. Drain Current @ $T_J = 25^\circ\text{C}$

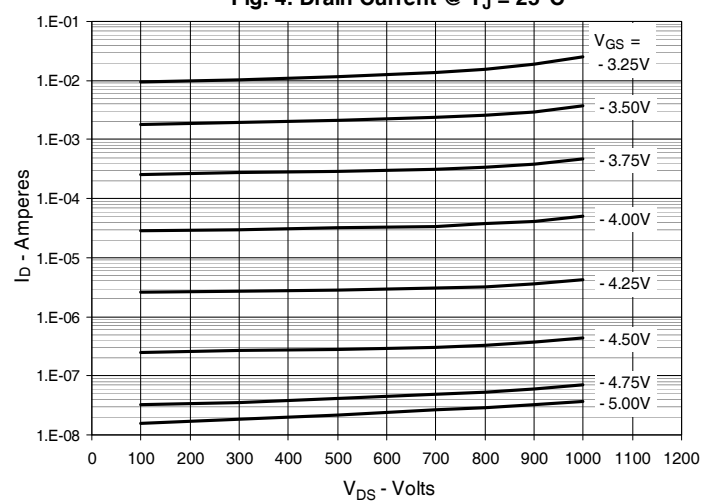

Fig. 5. Drain Current @ $T_J = 100^\circ\text{C}$

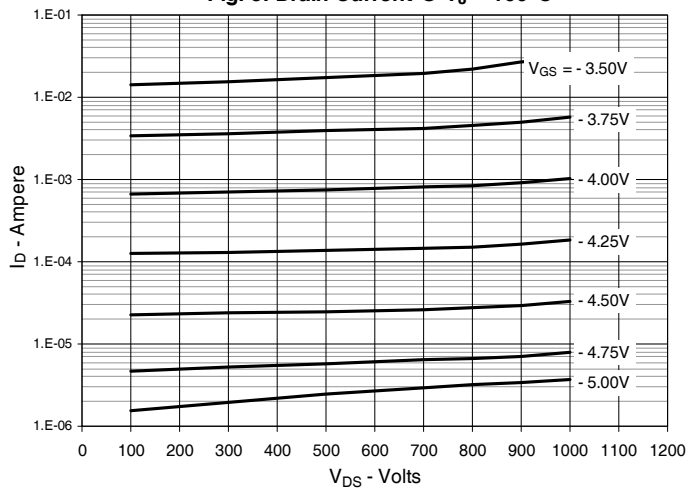

Fig. 6. Dynamic Resistance vs. Gate Voltage

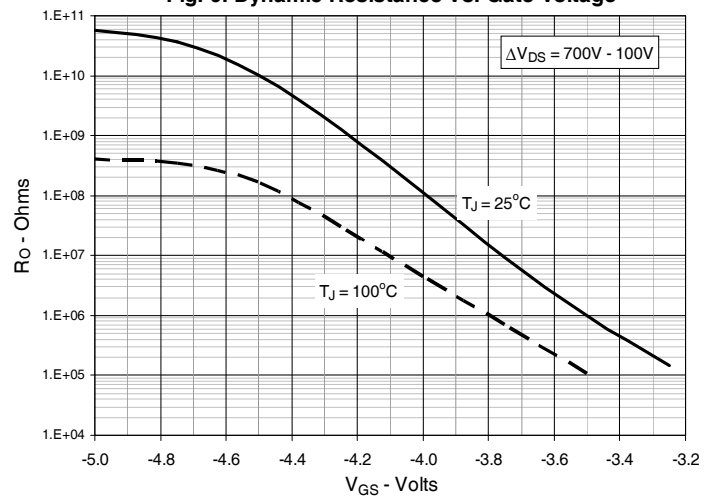

Fig. 7. Normalized $R_{DS(on)}$ vs. Junction Temperature

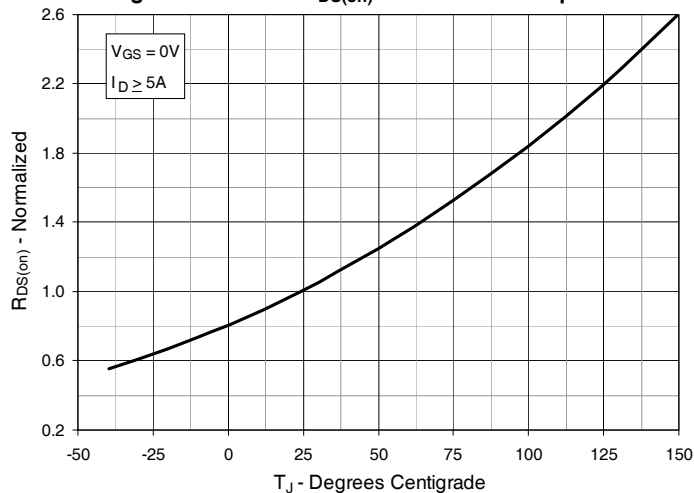

Fig. 8. $R_{DS(on)}$ Normalized to $I_D = 5A$ Value vs. Drain Current

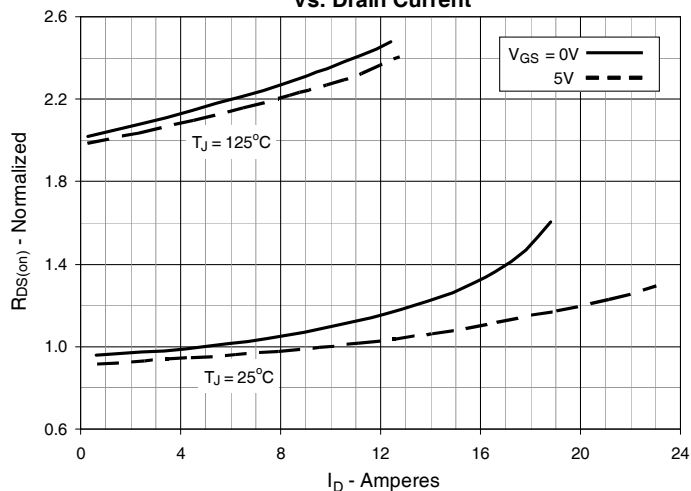

Fig. 9. Input Admittance

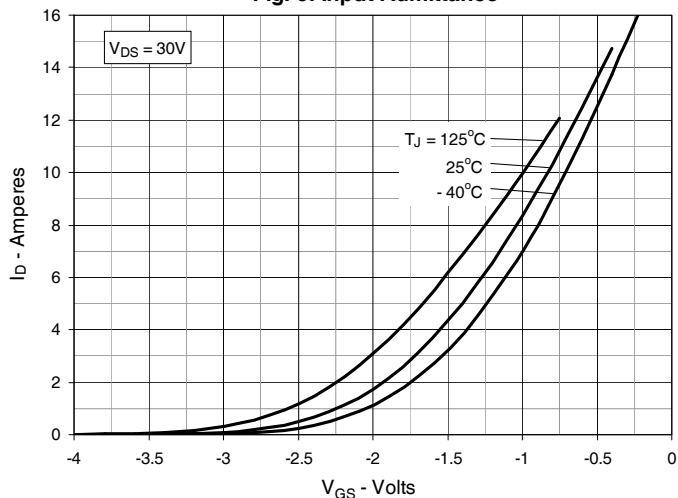

Fig. 10. Transconductance

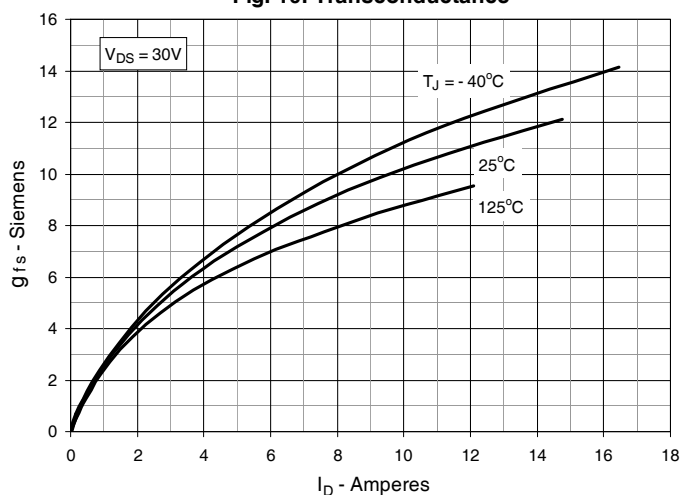

Fig. 11. Normalized Breakdown and Threshold Voltages vs. Junction Temperature

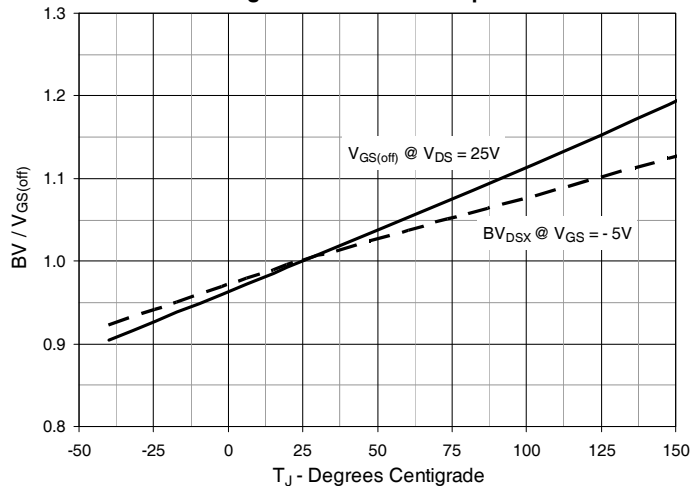

Fig. 12. Forward Voltage Drop of Intrinsic Diode

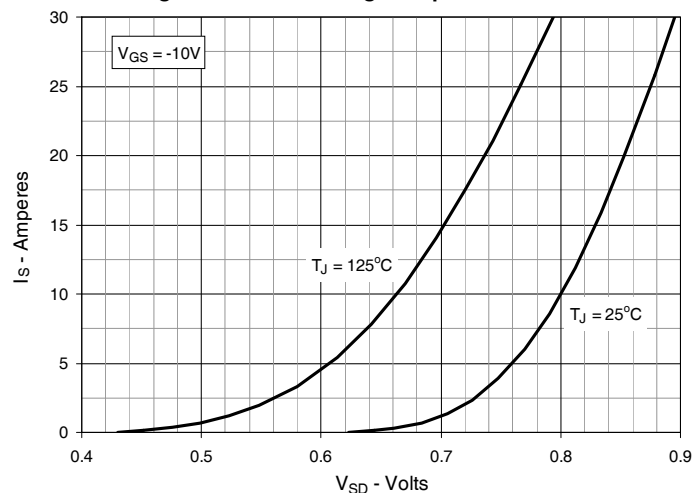

Fig. 13. Capacitance

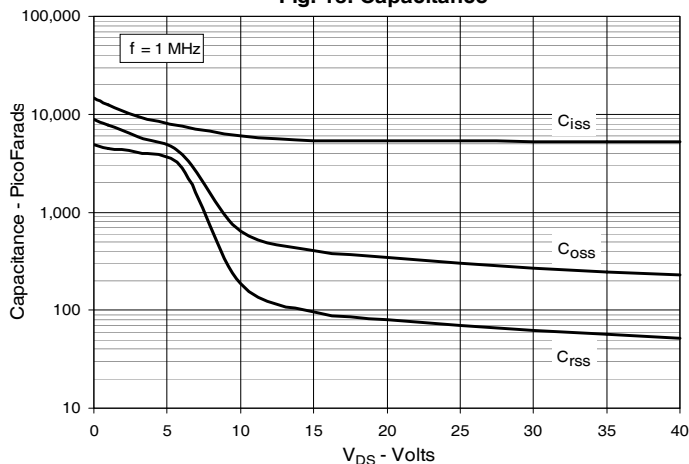

Fig. 14. Gate Charge

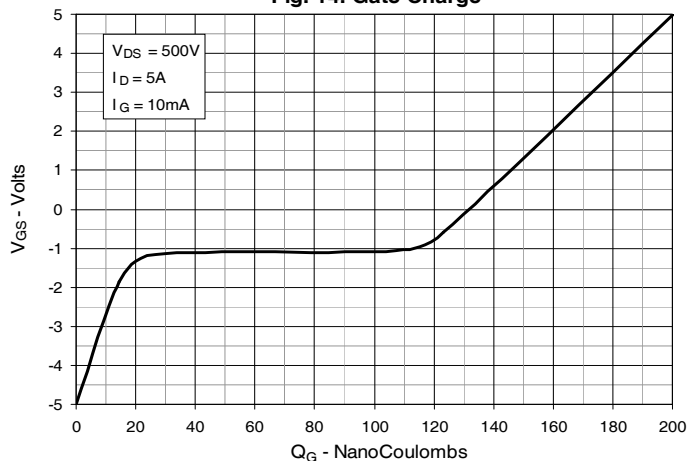

Fig. 15. Forward-Bias Safe Operating Area @ $T_C = 25^\circ\text{C}$

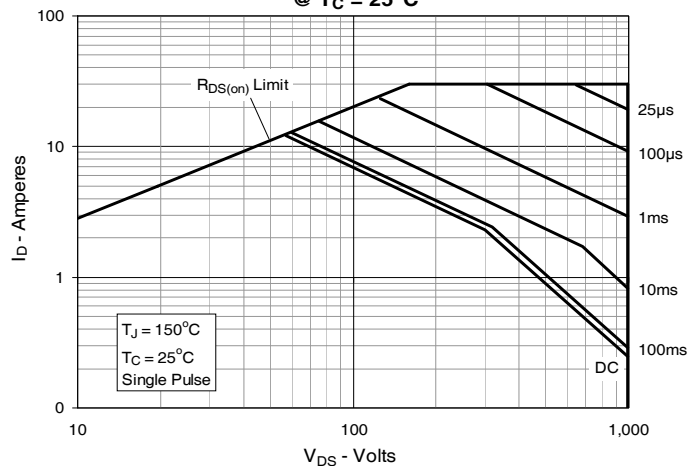

Fig. 16. Forward-Bias Safe Operating Area @ $T_C = 75^\circ\text{C}$

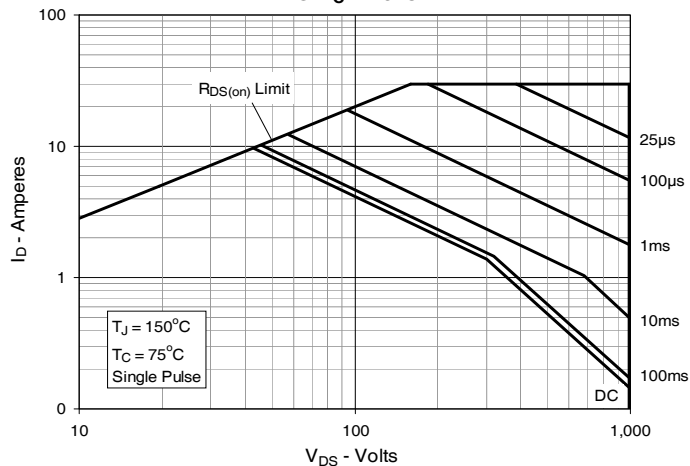
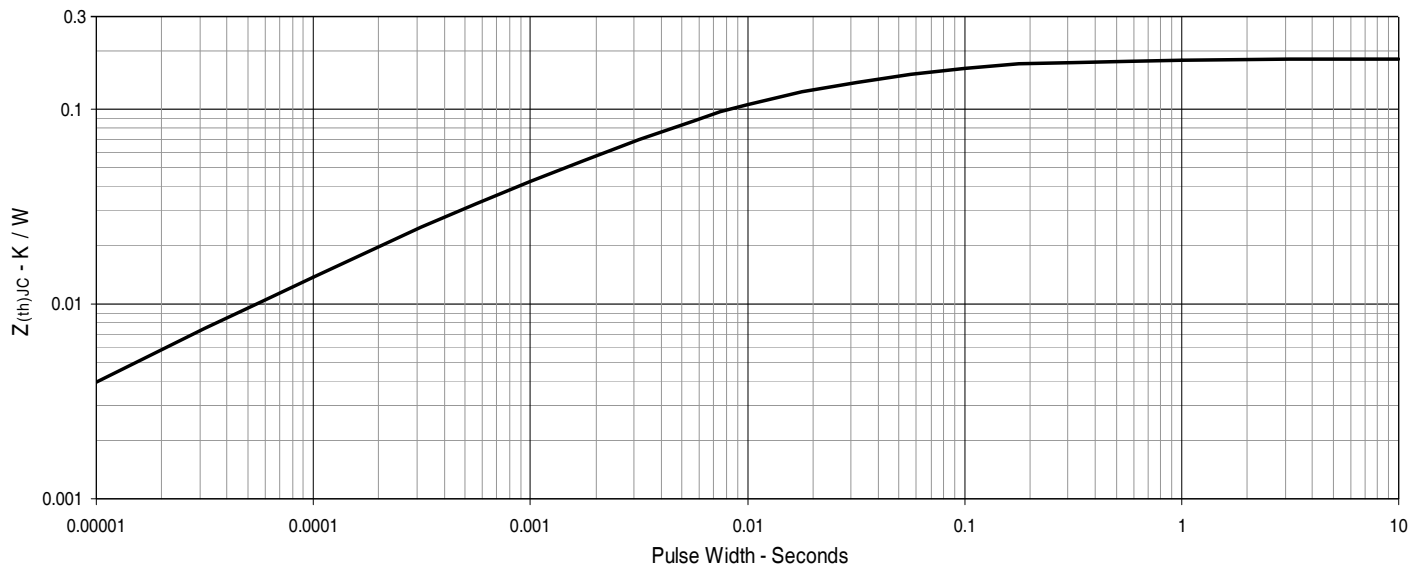

Fig. 17. Maximum Transient Thermal Impedance





Disclaimer Notice - Information furnished is believed to be accurate and reliable. However, users should independently evaluate the suitability of and test each product selected for their own applications. Littelfuse products are not designed for, and may not be used in, all applications. Read complete Disclaimer Notice at www.littelfuse.com/disclaimer-electronics.