

Glass Passivated General Purpose Plastic Rectifier

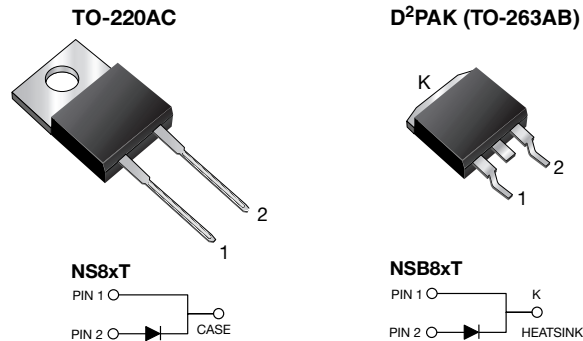

FEATURES

- Power pack
- Glass passivated pellet chip junction
- Low forward voltage drop
- High forward surge capability
- Meets MSL level 1, per J-STD-020, LF maximum peak of 245 °C for D²PAK (TO-263AB package)
- Solder dip 275 °C max. 10 s, per JESD 22-B106 for TO-220AC package
- AEC-Q101 qualified
- Material categorization: for definitions of compliance please see www.vishay.com/doc?99912

RoHS
COMPLIANT

LINKS TO ADDITIONAL RESOURCES



3D Models

PRIMARY CHARACTERISTICS	
$I_{F(AV)}$	8.0 A
V_{RRM}	50 V to 1000 V
I_{FSM}	125 A
V_F	1.1 V
T_J max.	150 °C
Package	TO-220AC, D ² PAK (TO-263AB)
Circuit configuration	Single

TYPICAL APPLICATIONS

For use in general purpose rectification of power supplies, inverters, converters and freewheeling diodes application.

MECHANICAL DATA

Case: TO-220AC, D²PAK (TO-263AB)

Molding compound meets UL 94 V-0 flammability rating

Base P/N-E3 - RoHS-compliant

Base P/NHE3_X - RoHS-compliant, AEC-Q101 qualified ("X" denotes revision code e.g. A, B,...)

Terminals: matte tin plated leads, solderable per J-STD-002 and JESD 22-B102

E3 suffix meets JESD 201 class 1A whisker test, HE3 suffix meets JESD 201 class 2 whisker test

Polarity: as marked

Mounting Torque: 10 in-lbs maximum

MAXIMUM RATINGS ($T_A = 25\text{ °C}$ unless otherwise noted)									
PARAMETER	SYMBOL	NS8AT	NS8BT	NS8DT	NS8GT	NS8JT	NS8KT	NS8MT	UNIT
Maximum repetitive peak reverse voltage	V_{RRM}	50	100	200	400	600	800	1000	V
Maximum RMS voltage	V_{RMS}	35	70	140	280	420	560	700	V
Maximum DC blocking voltage	V_{DC}	50	100	200	400	600	800	1000	V
Maximum average forward rectified current at $T_C = 100\text{ °C}$	$I_{F(AV)}$	8.0							A
Peak forward surge current 8.3 ms single sine-wave superimposed on rated load	I_{FSM}	125							A
Operating junction and storage temperature range	T_J, T_{STG}	-55 to +150							°C
Isolation voltage (ITO-220AC only) from terminal to heatsink $t = 1\text{ min}$	V_{AC}	1500							V



ELECTRICAL CHARACTERISTICS ($T_A = 25\text{ }^\circ\text{C}$ unless otherwise noted)											
PARAMETER	TEST CONDITIONS		SYMBOL	NS8AT	NS8BT	NS8DT	NS8GT	NS8JT	NS8KT	NS8MT	UNIT
Maximum instantaneous forward voltage	8.0 A	$T_J = 25\text{ }^\circ\text{C}$	$V_F^{(1)}$				1.1				V
Maximum DC reverse current at rated DC blocking voltage		$T_J = 25\text{ }^\circ\text{C}$	I_R				10				μA
		$T_J = 100\text{ }^\circ\text{C}$					100				
Typical junction capacitance	4.0 V, 1 MHz		C_J				55				pF

Note(1) Pulse test: 300 μs pulse width, 1 % duty cycle

THERMAL CHARACTERISTICS ($T_A = 25\text{ }^\circ\text{C}$ unless otherwise noted)					
PARAMETER	SYMBOL	NSXT	NSFXT	NSBXT	UNIT
Typical thermal resistance from junction to case	$R_{\theta JC}$	3.0	5.0	3.0	$^\circ\text{C/W}$

ORDERING INFORMATION (Example)					
PACKAGE	PREFERRED P/N	UNIT WEIGHT (g)	PACKAGE CODE	BASE QUANTITY	DELIVERY MODE
TO-220AC	NS8JT-E3/45	1.80	45	50/tube	Tube
TO-263AB	NSB8JT-E3/45	1.77	45	50/tube	Tube
TO-263AB	NSB8JT-E3/81	1.77	81	800/reel	Tape and reel
TO-220AC	NS8JT _{THE3} /45 ⁽¹⁾	1.80	45	50/tube	Tube
TO-263AB	NSB8JT _{THE3} _B/P ⁽¹⁾	1.77	P	50/tube	Tube
TO-263AB	NSB8JT _{THE3} _B/I ⁽¹⁾	1.77	I	800/reel	Tape and reel

Note

(1) AEC-Q101 qualified



RATINGS AND CHARACTERISTICS CURVES (T_A = 25 °C unless otherwise noted)

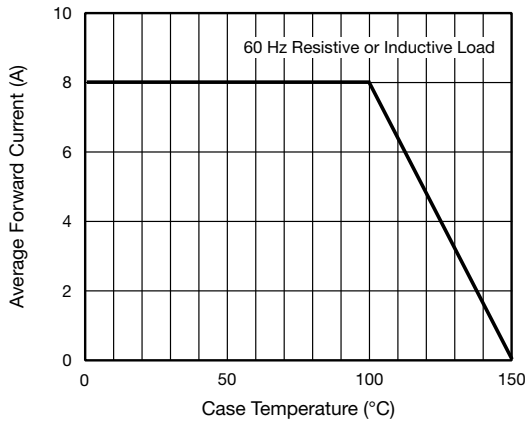

Fig. 1 - Forward Current Derating Curve

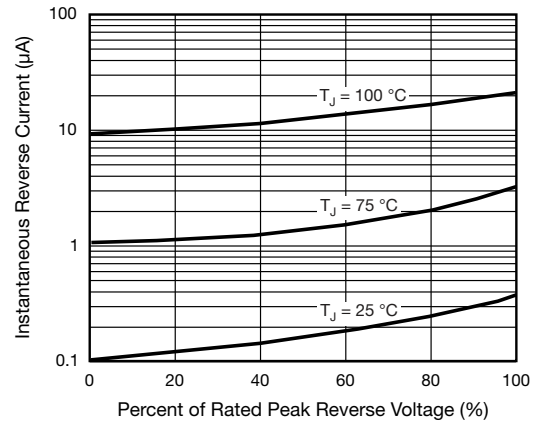

Fig. 4 - Typical Reverse Characteristics

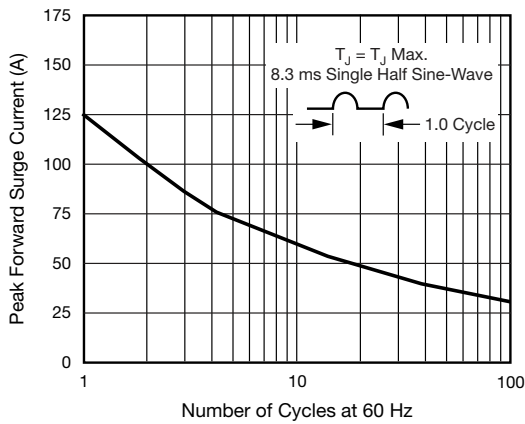

Fig. 2 - Maximum Non-Repetitive Peak Forward Surge Current

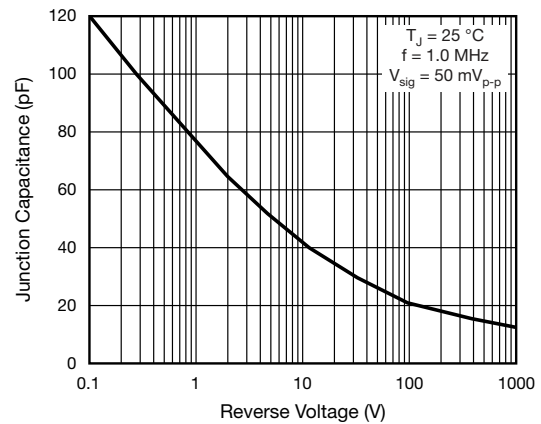

Fig. 5 - Typical Junction Capacitance Per Leg

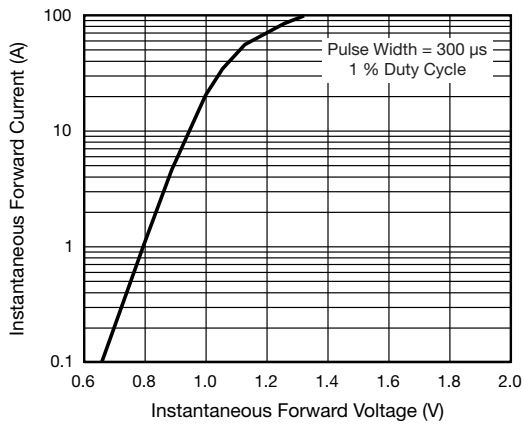
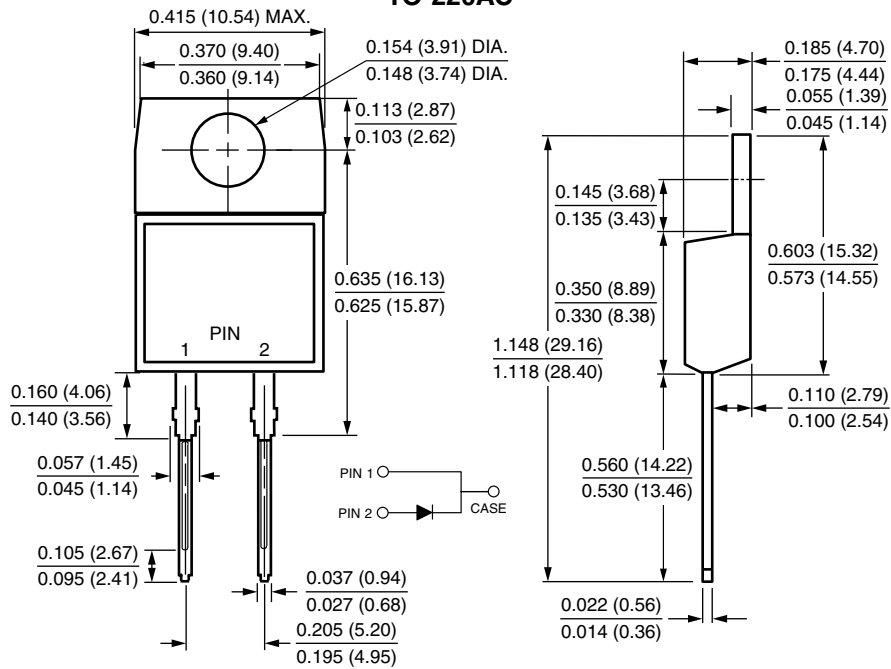

Fig. 3 - Typical Instantaneous Forward Characteristics

PACKAGE OUTLINE DIMENSIONS in inches (millimeters)

TO-220AC



D²PAK (TO-263AB)

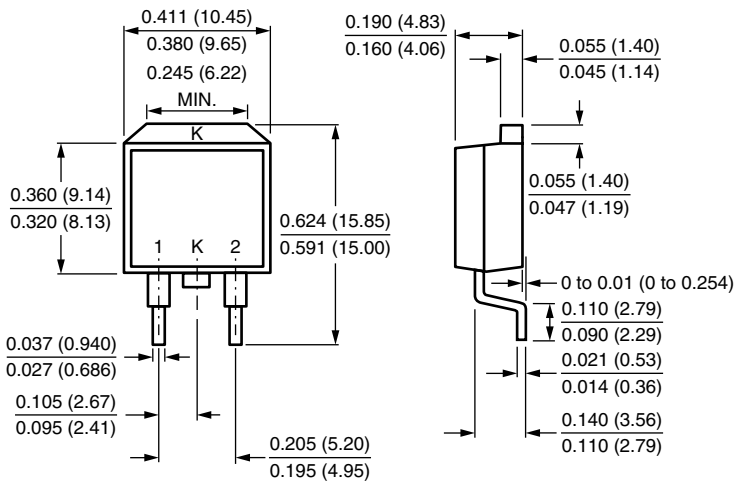

Mounting Pad Layout

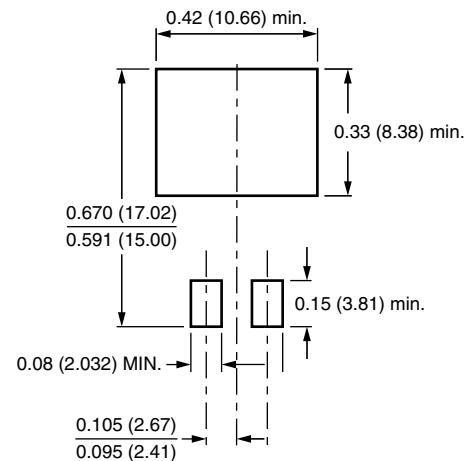



Disclaimer

ALL PRODUCT, PRODUCT SPECIFICATIONS AND DATA ARE SUBJECT TO CHANGE WITHOUT NOTICE TO IMPROVE RELIABILITY, FUNCTION OR DESIGN OR OTHERWISE.

Vishay Intertechnology, Inc., its affiliates, agents, and employees, and all persons acting on its or their behalf (collectively, "Vishay"), disclaim any and all liability for any errors, inaccuracies or incompleteness contained in any datasheet or in any other disclosure relating to any product.

Vishay makes no warranty, representation or guarantee regarding the suitability of the products for any particular purpose or the continuing production of any product. To the maximum extent permitted by applicable law, Vishay disclaims (i) any and all liability arising out of the application or use of any product, (ii) any and all liability, including without limitation special, consequential or incidental damages, and (iii) any and all implied warranties, including warranties of fitness for particular purpose, non-infringement and merchantability.

Statements regarding the suitability of products for certain types of applications are based on Vishay's knowledge of typical requirements that are often placed on Vishay products in generic applications. Such statements are not binding statements about the suitability of products for a particular application. It is the customer's responsibility to validate that a particular product with the properties described in the product specification is suitable for use in a particular application. Parameters provided in datasheets and / or specifications may vary in different applications and performance may vary over time. All operating parameters, including typical parameters, must be validated for each customer application by the customer's technical experts. Product specifications do not expand or otherwise modify Vishay's terms and conditions of purchase, including but not limited to the warranty expressed therein.

Hyperlinks included in this datasheet may direct users to third-party websites. These links are provided as a convenience and for informational purposes only. Inclusion of these hyperlinks does not constitute an endorsement or an approval by Vishay of any of the products, services or opinions of the corporation, organization or individual associated with the third-party website. Vishay disclaims any and all liability and bears no responsibility for the accuracy, legality or content of the third-party website or for that of subsequent links.

Except as expressly indicated in writing, Vishay products are not designed for use in medical, life-saving, or life-sustaining applications or for any other application in which the failure of the Vishay product could result in personal injury or death. Customers using or selling Vishay products not expressly indicated for use in such applications do so at their own risk. Please contact authorized Vishay personnel to obtain written terms and conditions regarding products designed for such applications.

No license, express or implied, by estoppel or otherwise, to any intellectual property rights is granted by this document or by any conduct of Vishay. Product names and markings noted herein may be trademarks of their respective owners.