

# Using the UCC25800EVM-037 2-W LLC Converter for Traction Inverter Driver Bias Power Supplies



## ABSTRACT

This isolated, open-loop LLC transformer driver converter is based on the device UCC25800. It has a pair of outputs, +18 V and -5 V, and provides output power up to 2 W from a DC input between 6-V and 26-V. The converter provides isolated bias power to SiC MOSFET or IGBT gate drivers for traction inverter and industrial inverter applications.

## Table of Contents

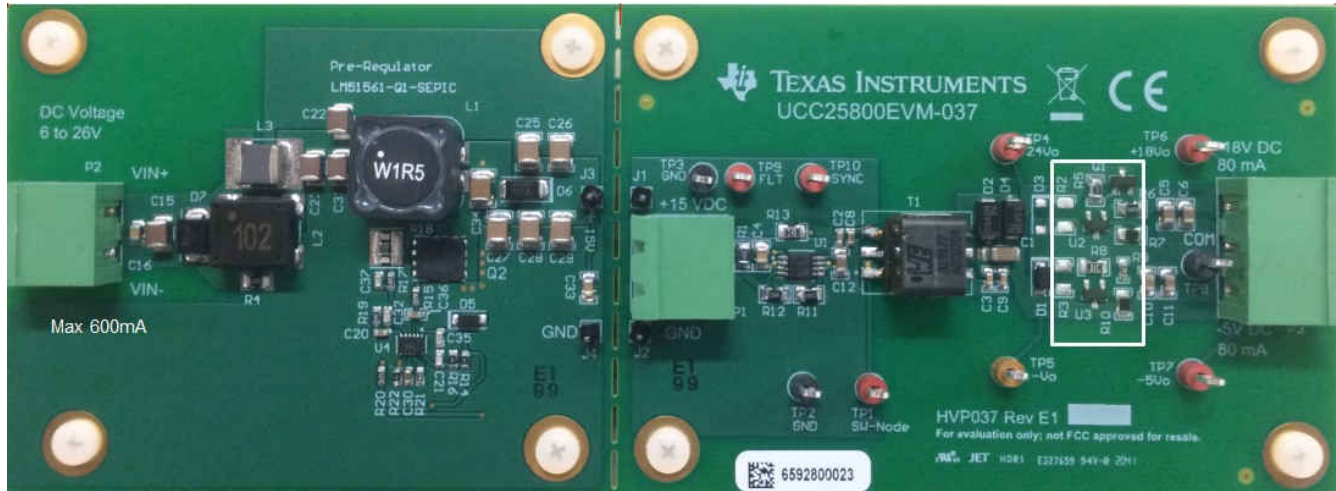
<b>1 Description</b>	<b>2</b>
<b>2 Electrical Performance Specifications</b>	<b>3</b>
<b>3 Schematic Diagram</b>	<b>4</b>
<b>4 Description - How to Use</b>	<b>6</b>
4.1 Typical Applications	6
4.2 Using the EVM with on-board Pre-regulator on Board	6
4.3 Using the EVM with an External DC Voltage Source	6
<b>5 Test Setup</b>	<b>7</b>
5.1 Test Setup Requirements	7
5.2 Test Setup Diagram	7
5.3 Test Points and Input / Output Terminals	7
<b>6 Performance Data and Typical Characteristic Curves</b>	<b>9</b>
6.1 Efficiency Result of the LLC Board with External DC Input Voltage	9
6.2 Efficiency Result of the LLC Board with Pre-regulator on Board	10
6.3 Efficiency Typical Results	11
6.4 Output Characteristics	11
6.5 Output Voltage Turn-on at Start Up	11
6.6 Output Ripple Voltage	12
6.7 Frequency Synchronized to External Signal	12
6.8 DIS-pin Enable and Dis-Enable	12
6.9 Load Transient Response	12
6.10 Switch-node Voltage and Current	13
6.11 Over-Current Limit and FLT-pin	13
6.12 CISPR-25 Class-5 Conducted EMI Test Result - Pass	14
6.13 Thermal Images at Full Load	15
<b>7 Transformer Details</b>	<b>16</b>
<b>8 EVM Assembly and Layout</b>	<b>17</b>
<b>9 List of Materials</b>	<b>18</b>
<b>10 Revision History</b>	<b>20</b>

## Trademarks

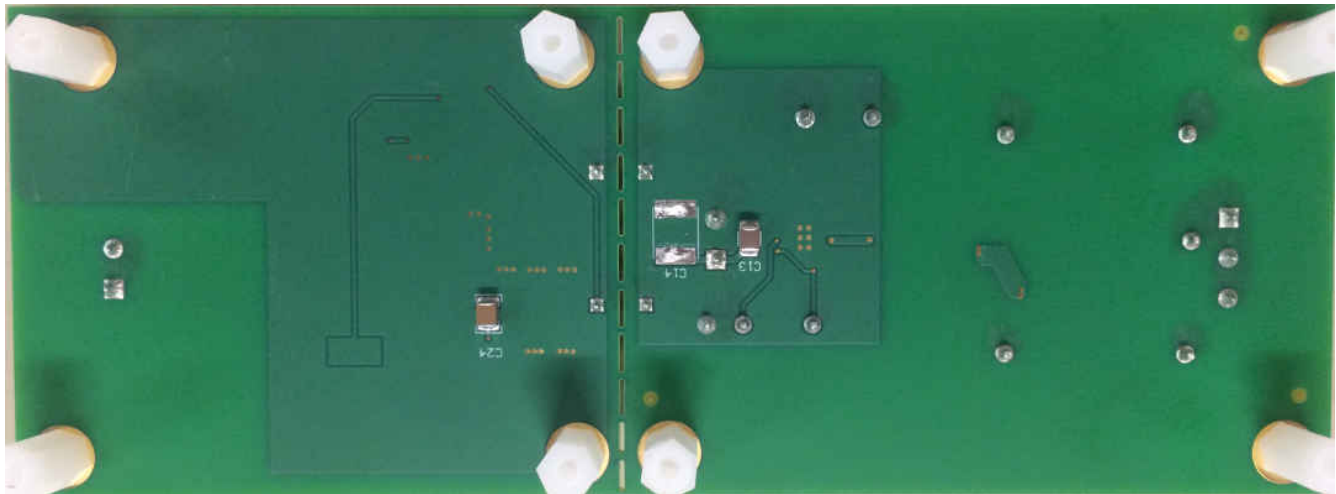
All trademarks are the property of their respective owners.

## 1 Description

The LLC topology allows the transformer to have significant leakage inductance, but much smaller primary-to-secondary capacitance, which significantly reduces common-mode current injection through the bias transformer. The LLC converter based on UCC25800 offers a high level of integration, low cost and high efficiency in a compact form factor. The EVM consists of two portions, namely, the pre-regulator board (left half) and the LLC board (right half). The two portions of the board can be used together or used only with the LLC board, as needed for evaluation. For details how to use this EVM, please refer to Section 5.



**Figure 1-1. UCC25800EVM-037 top view (white blocked components optional, only needed for 1% load regulation)**



**Figure 1-2. UCC25800EVM-037 bottom view**

## 2 Electrical Performance Specifications

**Table 2-1. UCC25800EVM-037 Electrical Performance Specifications<sup>(1)</sup>**

PARAMETER		TEST CONDITIONS	MIN	NOM	MAX	UNIT
<b>INPUT CHARACTERISTICS</b>						
$V_{IN}$	Input voltage, DC		6	12	26	V
$I_{IN}$	Input current at full load	$V_{IN} = 6\text{ V}$	535			mA
		$V_{IN} = 12\text{ V}$	285			
		$V_{IN} = 26\text{ V}$	140			
<b>OUTPUT CHARACTERISTICS</b>						
$V_{OUT1}$	Set-point, DC	$V_{IN} = 6\text{ to }26\text{ V}$	17.93	18.10	18.27	V
$I_{OUT1}$	Output current range	$V_{IN} = 6\text{ to }26\text{ V}$	0		85	mA
$V_{OUT1}$	Load regulation	$I_{OUT1} = I_{OUT2}$ No load to full load	-1.0		1.0	%
$V_{OUT1}$	PK-to-pk ripple	$I_{OUT1} = I_{OUT2}$ at full load	50			mV
$V_{OUT2}$	Set-point, DC	$V_{IN} = 6\text{ to }26\text{ V}$	-5.02	-4.98	-4.94	V
$I_{OUT2}$	Output current range	$V_{IN} = 6\text{ to }26\text{ V}$	-85		0	mA
$V_{OUT2}$	Load regulation	$I_{OUT1} = I_{OUT2}$ No load to full load	-1.0		1.0	%
$V_{OUT2}$	PK-to-pk ripple	$I_{OUT1} = I_{OUT2}$ at full load	35			mV
<b>SYSTEMS CHARACTERISTICS</b>						
$\eta$	Efficiency, with pre-regulator	$I_{OUT1} = I_{OUT2}$ $V_{IN} = 12\text{ V}$ , full load	59.3			%
$\eta$	Efficiency, without pre-regulator	$I_{OUT1} = I_{OUT2}$ $V_{IN} = 15.6\text{ V}$ , full load	82.8			%
$\eta$	Efficiency, w/o pre-regulator and w/o output LDO	$I_{OUT1} = I_{OUT2}$ $V_{IN} = 15.6\text{ V}$ , full load	88.1			%
$f_{SW}$	LLC Switching frequency	Normal operation	500			kHz
OCL	Output over-current limit	$V_{IN} = 6\text{ to }26\text{ V}$	100			mA
$T_{HOT}$	Max temperature on board	Ambient temperature $T_{AMB} = 25\text{ }^{\circ}\text{C}$	< 55			$^{\circ}\text{C}$
$V_{POUT}$	Pre-regulator output voltage	$V_{IN} = 6\text{ to }26\text{ V}$	15.6			V

(1) The performance listed in this table is achieved based on the test results from a single board.

### 3 Schematic Diagram

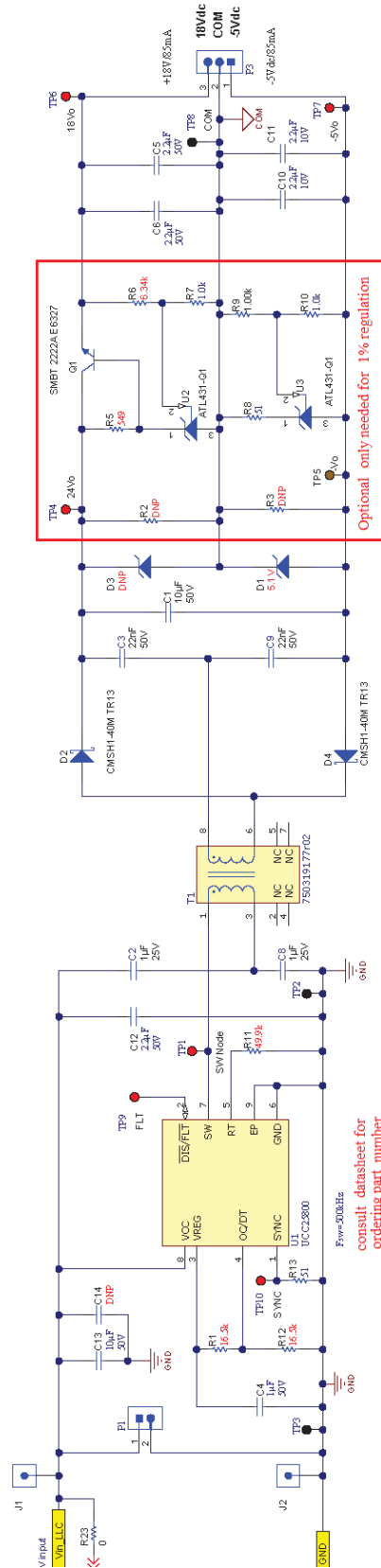


Figure 3-1. UCC25800EVM-037 Schematic Diagram (1 of 2)

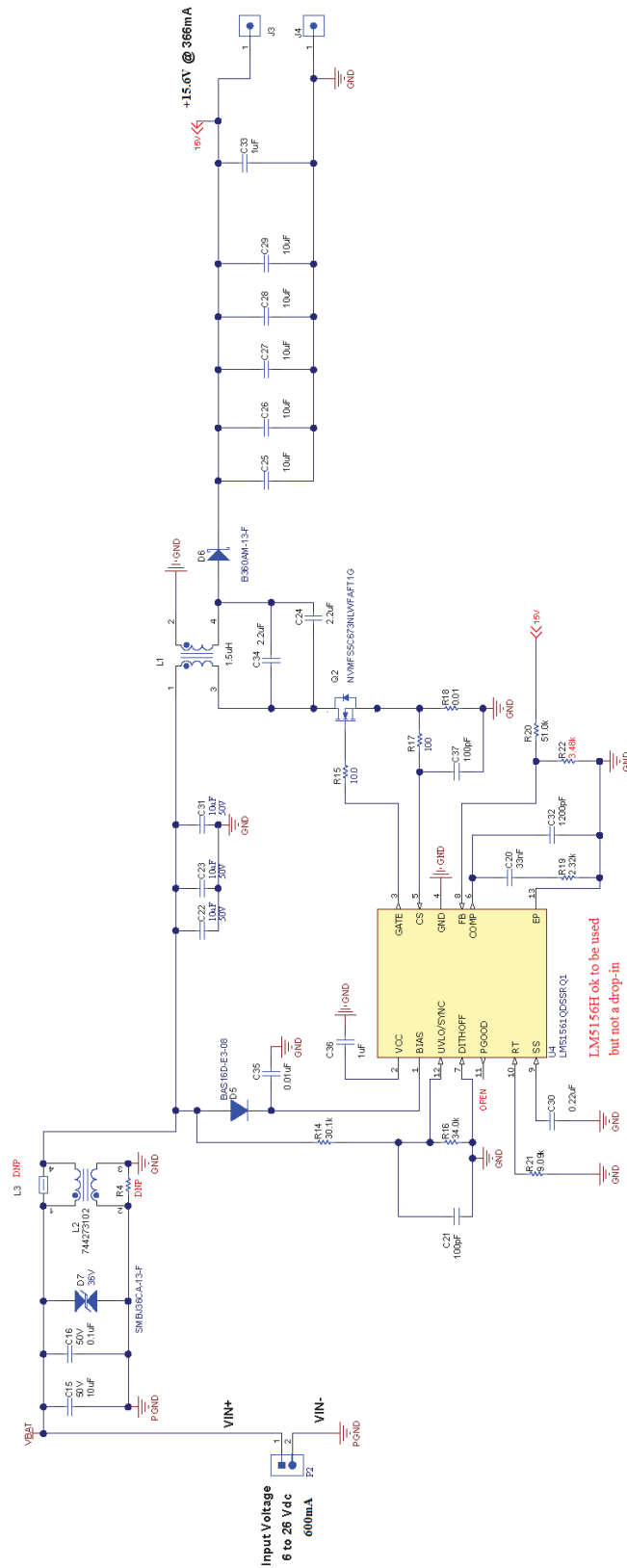


Figure 3-2. UCC25800EVM-037 Schematic Diagram (2 of 2)

## 4 Description - How to Use

### 4.1 Typical Applications

- Driver isolated bias power supplies for SiC MOSFET traction inverters
- Driver isolated bias power supplies for IGBT traction inverters
- Industrial inverter driver isolated bias power supplies

### 4.2 Using the EVM with on-board Pre-regulator on Board

When using UCC25800EVM-037 with its on-board pre-regulator, connect J1 to J3 and J2 to J4. The pre-regulator input voltage at terminal P2 is DC voltage between 6 V and 26 V, and its output voltage at J3 and J4 is 15.6 V. The Bias board has two DC outputs, 18 V and -5 V at terminal P3.

**Note:** if resistor R23 exists, then the connection between J1 and J3 is already made through R23.

### 4.3 Using the EVM with an External DC Voltage Source

UCC25800EVM-037 board can be used with an external DC voltage, regulated at 15.6 V. In such a case, connect external DC voltage to J1 (+) and J2 (-). The board can be broken into two, the pre-regulator board, and the LLC board. In this case the external DC voltage can be also connected to terminal P1. The LLC board has two DC outputs, 18V and -5 V.

**Note:** please check and remove R23 (if it exists) between J1 and J3 when using the board with an external DC voltage source.

## 5 Test Setup

### 5.1 Test Setup Requirements

**Voltage Source:** DC voltage source capable of handling 5 W power level with voltage range 5 to 30 V, and current capability not less than 1.0 A.

**Volt-meter:** Digital voltage meters

**Current-meter:** Digital current meters

**Oscilloscope:**

- 4-Channel, 500 MHz bandwidth.

**Output Load:** dual resistive or electronic load capable of handling 3 W at 20 V.

**Recommended Wire Gauge:** Insulated 20 AWG to 22 AWG.



#### WARNING

- If you are not trained on properly handling and testing power electronics please do not test this evaluation module.
- Read this user's guide thoroughly before making test.

### 5.2 Test Setup Diagram

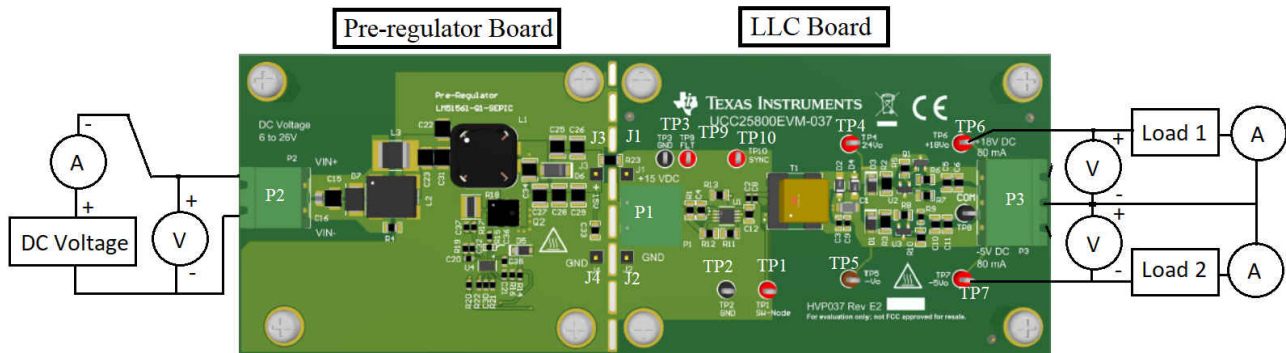


Figure 5-1. UCC25800EVM-037 Test Setup Diagram

### 5.3 Test Points and Input / Output Terminals

Table 5-1. Input / Output Terminals and Test Point Functions

Name	Location	Description
J1	LLC Board	Terminal, input (+), single connection
J2	LLC Board	Terminal, input (-), single connection
J3	Pre-regulator Board	Terminal, output (+), single connection
J4	Pre-regulator Board	Terminal, output (-), single connection

**Table 5-1. Input / Output Terminals and Test Point Functions (continued)**

<b>Name</b>	<b>Location</b>	<b>Description</b>
P1	LLC Board	Terminal, input, two connections
P2	Pre-regulator Board	Terminal, input, two connections
P3	LLC Board	Terminal, output, three connections
TP1	LLC Board	Test point, switch-node
TP2	LLC Board	Test point, GND
TP3	LLC Board	Test point, GND
TP4	LLC Board	Test point, 24Vo
TP5	LLC Board	Test point, -Vo
TP6	LLC Board	Test point, +18Vo
TP7	LLC Board	Test point, -5Vo
TP8	LLC Board	Test point, COM
TP9	LLC Board	Test point, FLT/DIS
TP10	LLC Board	Test point, SYNC

**Note:** if R23 exists between J1 and J3, the connection between J1 and J3 is already made through R23.



## 6 Performance Data and Typical Characteristic Curves

### 6.1 Efficiency Result of the LLC Board with External DC Input Voltage

**Table 6-1. Efficiency Test Result**

$V_{IN}$  is applied on P1 terminal, or on J1 and J2. No connection from J1 to J3, and R23 removed

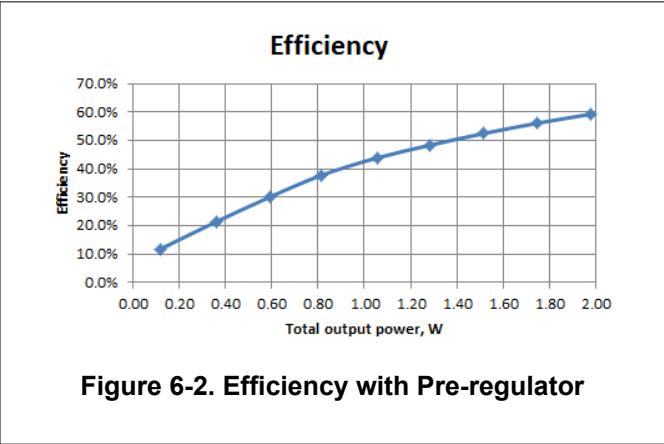
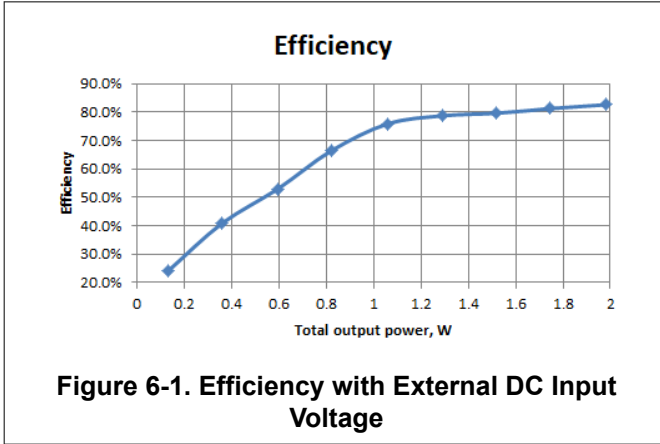
$V_{IN}$ (V)	$I_{IN}$ (mA)	$V_{OUT1}$ (V)	$I_{OUT1}$ (mA)	$V_{OUT2}$ (V)	$I_{OUT1}$ (mA)	Efficiency (%)
15.686	34.93	18.122	5.883	-4.987	-5.124	24.12
15.598	56.32	18.122	15.605	-4.978	-15.193	40.80
15.686	71.56	18.123	25.852	-4.969	-25.300	52.90
15.666	78.94	18.127	35.630	-4.969	-35.160	66.35
15.644	89.19	18.136	45.940	-4.990	-45.050	75.82
15.605	105.05	18.137	55.94	-4.990	-55.210	78.70
15.717	121.27	18.136	65.67	-4.990	-65.330	79.59
15.686	137.00	18.138	75.58	-4.990	-75.100	81.23
15.654	153.11	18.140	85.69	-4.990	-85.250	82.60

## 6.2 Efficiency Result of the LLC Board with Pre-regulator on Board

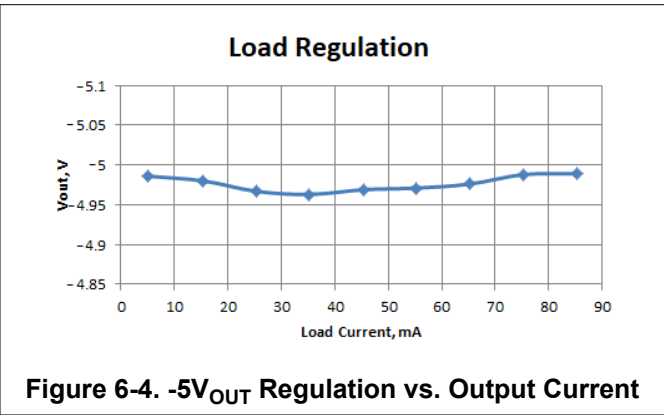
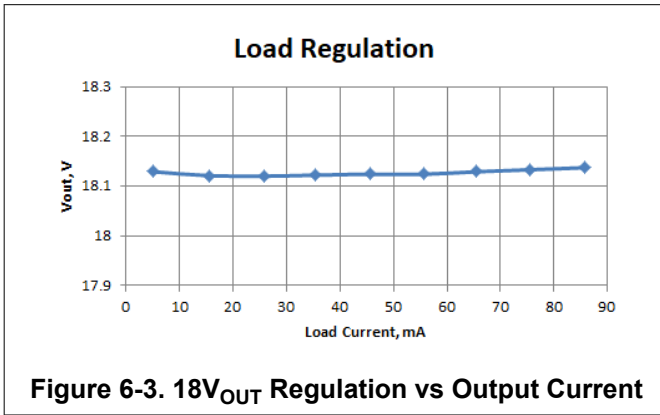
**Table 6-2. Efficiency Test Result ( $V_{IN}$  is applied on P2 terminal, connection made from J1 to J3, or R23 in place, and connection made from J2 to J4)**

$V_{IN}$ (V)	$I_{IN}$ (mA)	$V_{OUT1}$ (V)	$I_{OUT1}$ (mA)	$V_{OUT2}$ (V)	$I_{OUT2}$ (mA)	Efficiency (%)
12.082	82.40	18.129	5.087	-4.986	-5.003	11.77
12.042	139.50	18.121	15.604	-4.980	-15.389	21.39
12.030	163.30	18.120	25.721	-4.967	-25.260	30.11
12.039	179.10	18.122	35.330	-4.963	-35.160	37.79
12.023	200.00	18.124	45.740	-4.969	-45.480	43.87
12.042	220.60	18.124	55.76	-4.971	-55.310	48.39
12.028	239.90	18.129	65.570	-4.976	-65.150	52.43
12.053	258.40	18.133	75.58	-4.988	-75.380	56.08
12.034	277.20	18.137	85.690	-4.989	-85.240	59.29

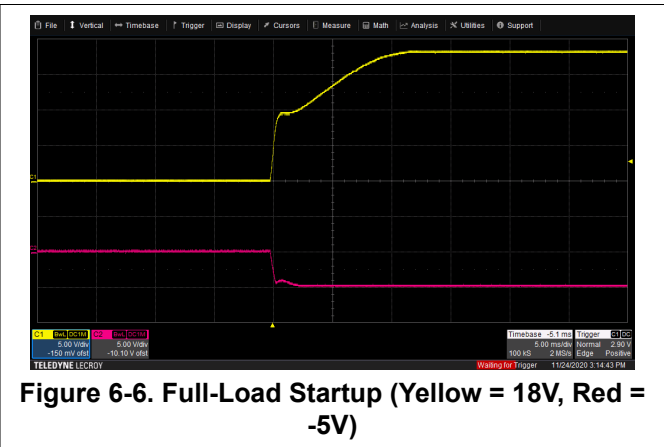
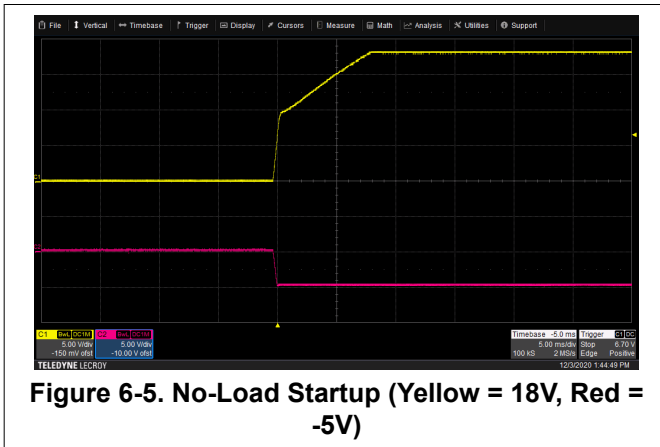
### 6.3 Efficiency Typical Results



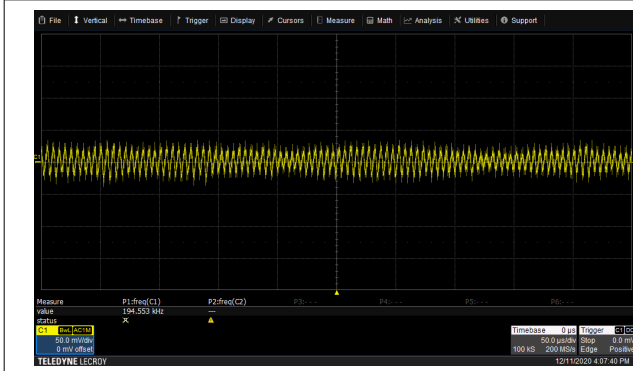
### 6.4 Output Characteristics



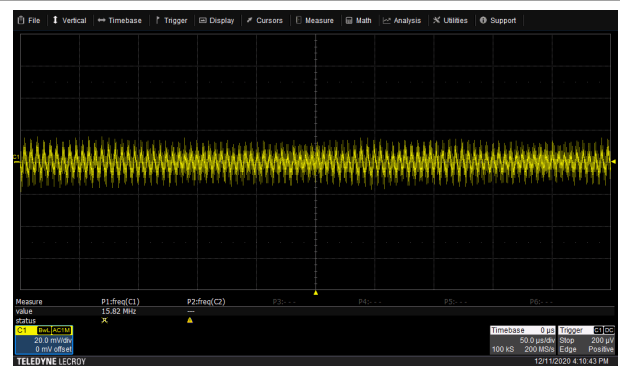
### 6.5 Output Voltage Turn-on at Start Up



## 6.6 Output Ripple Voltage



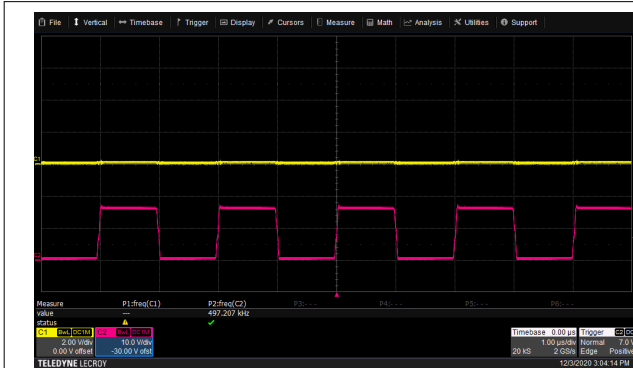
**Figure 6-7. Ripple Voltage peak-to-peak about 50 mV @ 18 V<sub>OUT</sub> and full load**



**Figure 6-8. Ripple Voltage peak-to-peak about 35mV @ -5 V<sub>OUT</sub> and full load**

## 6.7 Frequency Synchronized to External Signal

Yellow = External signal on SYNC, Red = Switch-node



**Figure 6-9. Fsw = 497 kHz without external sync**



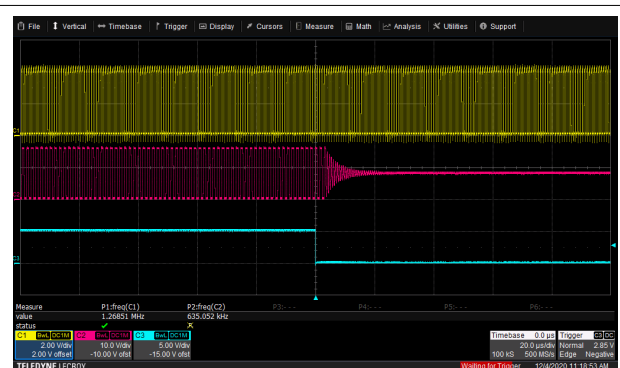
**Figure 6-10. Fsw = 577 kHz with external sync = 1.155 MHz (577 kHz x 2 = 1.154 MHz)**

## 6.8 DIS-pin Enable and Dis-Enable

Yellow = External SYNC, Red = Switch-node fsw, Blue = DIS-pin



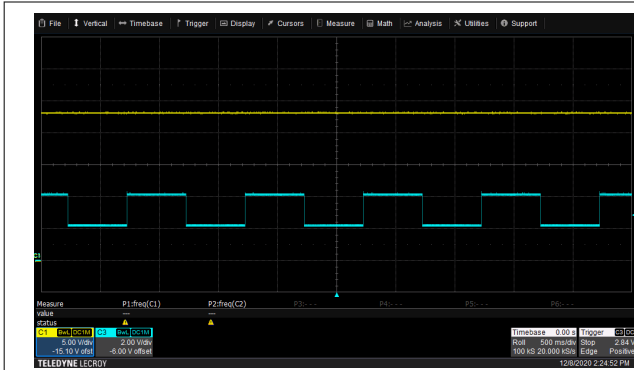
**Figure 6-11. DIS-pin Enable**



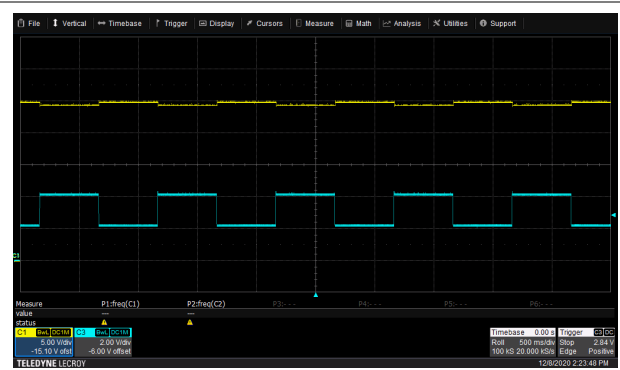
**Figure 6-12. DIS-pin Dis-enable**

## 6.9 Load Transient Response

Yellow = V<sub>OUT</sub>, DC coupled, Blue = Load Current, repetitive change between 50% (42.5mA) and 100% (85mA)

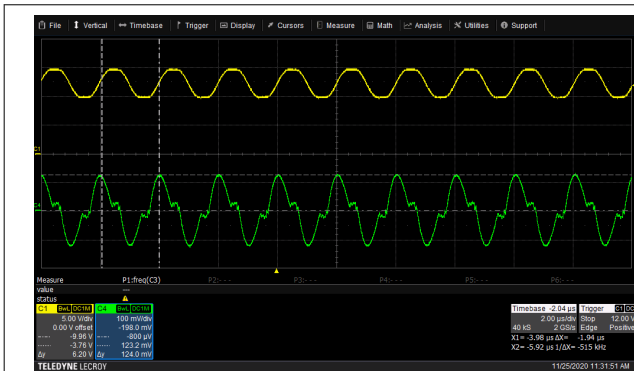


**Figure 6-13. Load Transient Response, measured between TP6 and TP7 (a. no  $V_{OUT}$  deviation observed due to the LDO; b.  $V_{OUT} = 23V$ )**

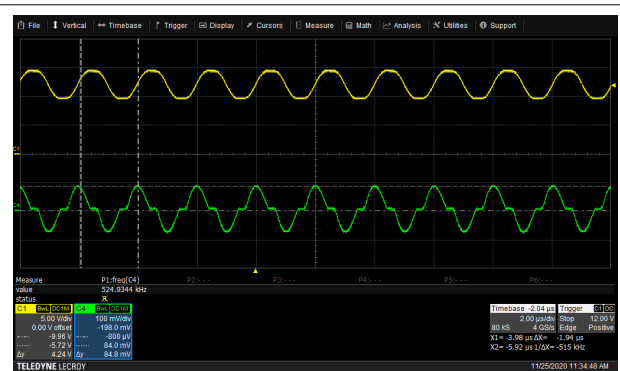


**Figure 6-14. Load Transient Response, measured between TP4 and TP5 (a.  $V_{OUT}$  deviation between 24.2V and 24.7V; b.  $V_{OUT} = 24.4V$ )**

### 6.10 Switch-node Voltage and Current

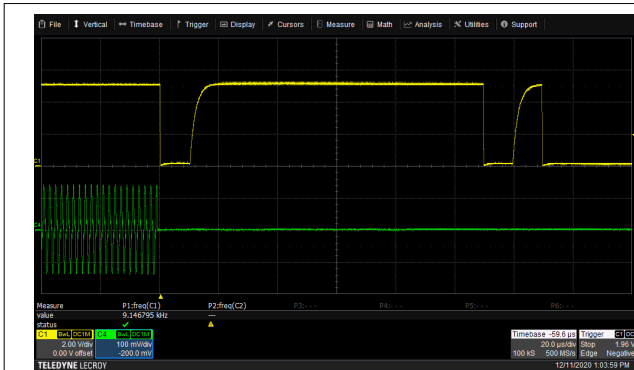


**Figure 6-15. Switch-node Voltage (yellow) and Primary-side Current (0.2V/A) at Full Load**

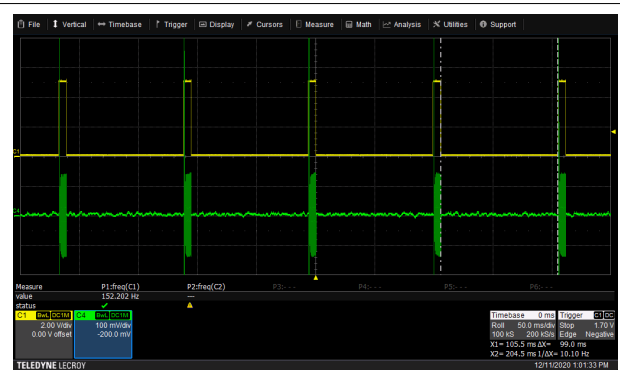


**Figure 6-16. Resonant Capacitor Voltage (yellow) and Secondary-side Current (0.2V/A) at Full Load**

### 6.11 Over-Current Limit and FLT-pin



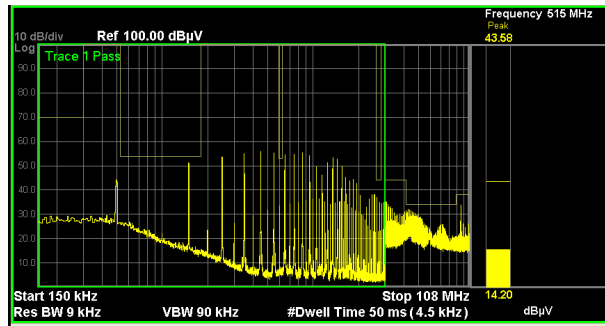
**Figure 6-17. Switch-node Voltage (yellow) and Primary Current (0.2V/A) at Full Load**



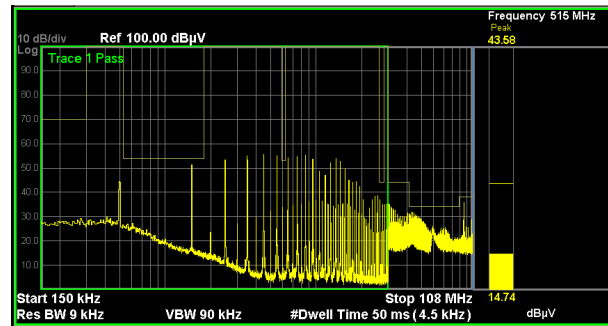
**Figure 6-18. Load Transient Response, measured between 24Vo and -Vo (after Q1)**

## 6.12 CISPR-25 Class-5 Conducted EMI Test Result - Pass

The LLC board EMI test results present a pass in terms of CISPR-25 Class-5 Conducted EMI Peak Limits. The results shown in the below figures are based on the LLC board with L1, D5, R4 and R23 removed, and connect L3 (pin 3 and 4) to J2 and J1. The connection from L3 to J2 and J1 is through a twisted pair of wires.



**Figure 6-19. Peak Limits on Positive Polarity (LLC Board), Pass**



**Figure 6-20. Peak Limits on Negative Polarity (LLC Board), Pass**

### Note

Please note this was evaluated on an EMI station for pre-qualification purpose only. It is recommended that all final designs be verified by an agency-qualified EMI test house.

### 6.13 Thermal Images at Full Load

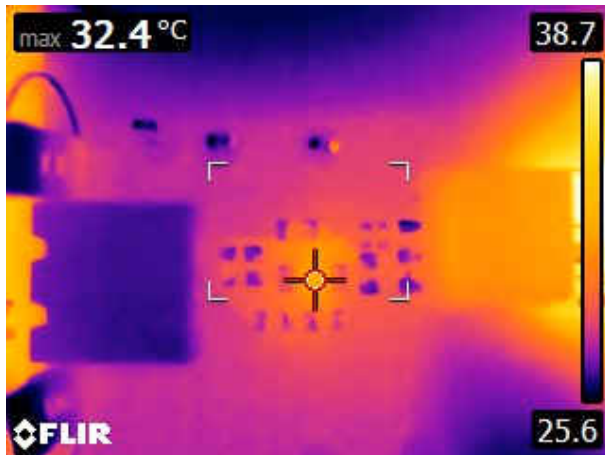


Figure 6-21.  $V_{IN} = 12\text{ V}_{DC}$ , left-half LLC board, with pre-regulator

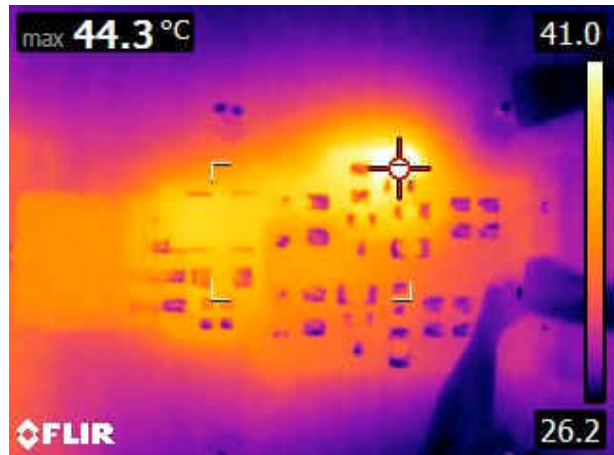


Figure 6-22.  $V_{IN} = 12\text{ V}_{DC}$ , right-half LLC board, with pre-regulator

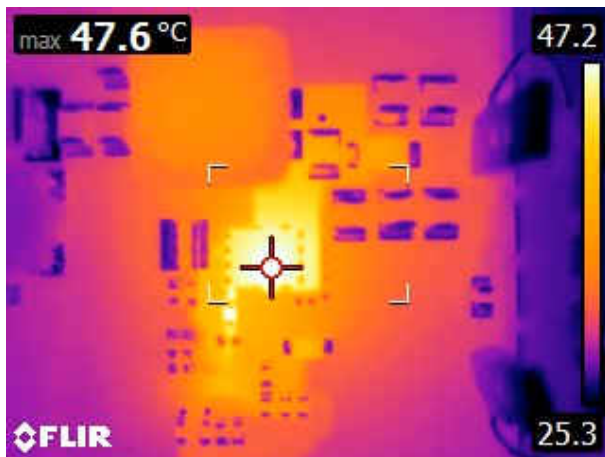


Figure 6-23.  $V_{IN} = 12\text{ V}_{DC}$ , pre-regulator board

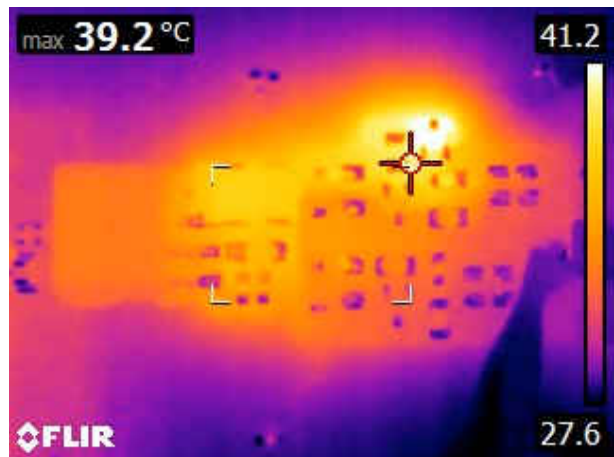
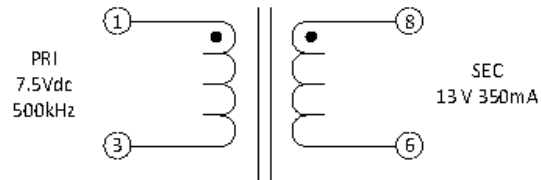


Figure 6-24.  $V_{IN} = 15.6\text{ V}_{DC}$ , right-half LLC board, without pre-regulator

## 7 Transformer Details

Würth Elektronik transformer part number 750319177 is used on this design.



**Figure 7-1. Transformer Schematic Diagram**

**Table 7-1. Transformer Specifications at 20°C**

PARAMETER	VALUE	PINS/LEADS	TEST CONDITIONS
Inductance ( $\mu\text{H}$ )	Min: 16.5	1 – 3	Open all other pins, 100kHz, 0.1V
Leakage Inductance ( $\mu\text{H}$ )	Typ: 0.55, Max: 0.75	1 – 3	Short 6 - 8, 10kHz, 0.1V
D.C. resistance ( $\Omega$ )	0.045, $\pm 20\%$	1 – 3	
D.C. resistance ( $\Omega$ )	0.122 $\pm 10\%$	8 – 6	
Dielectric (VAC)	2500	1, 3 – 6	1 s
Turns-ratios	1 : 1.67, $\pm 2\%$	(1-3):(6-8)	
Operating Temperature Range	-40 to 150 °C		Temperature-rise included

Note: Pin 2, 4, 5, and 7 are no-connection pins



## 8 EVM Assembly and Layout

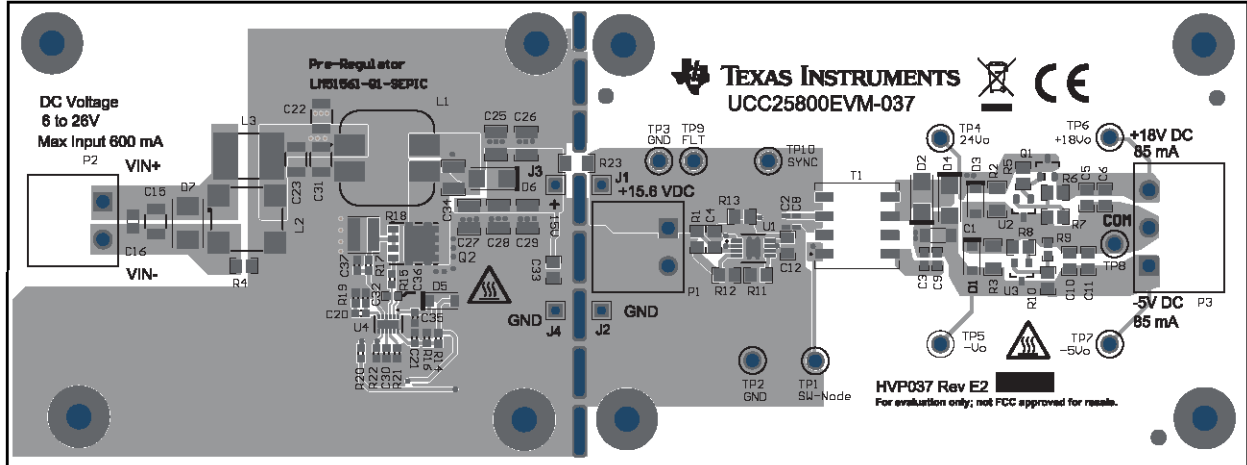


Figure 8-1. EVM Assembly (Top View)

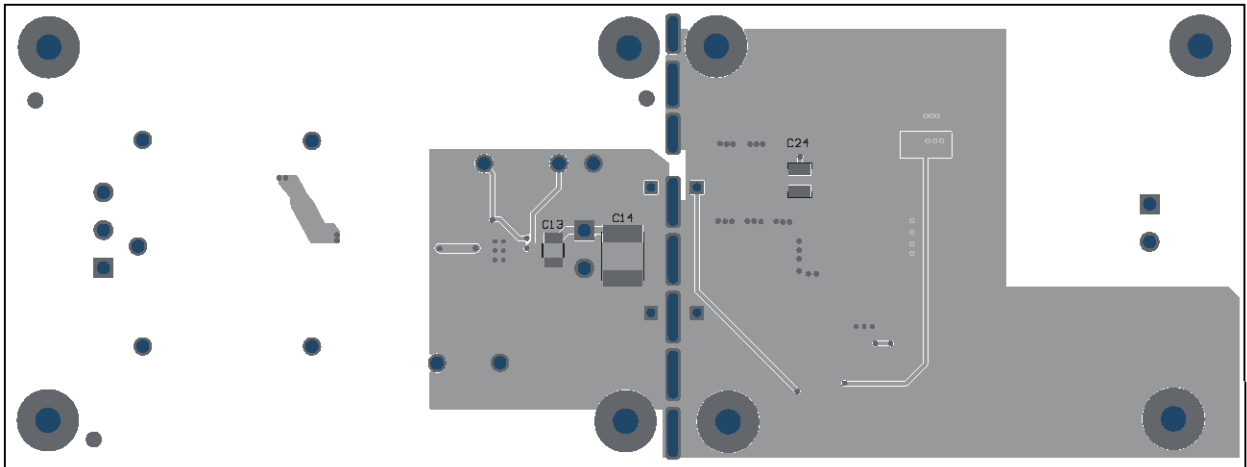


Figure 8-2. EVM Assembly (Bottom View)

## 9 List of Materials

UCC28782EVM-030 list of materials for the schematic diagrams shown in [Figure 3-1](#) and in [Figure 3-2](#).

**Table 9-1. UCC28782EVM-030 List of Materials**

Quantity	Designator	Description	Part Number	Manufacturer
1	C1	Capacitor, ceramic, 10 $\mu$ F, 50 V, 10%, X7R, AEC-Q200, Grade 1, 1206	CGA5L1X7R1H106K160AC	TDK
2	C2, C8	Capacitor, ceramic, 1.0 $\mu$ F, 25 V, 10%, X7R, AEC-Q200, Grade 1, 0603	CGA3E1X7R1E105K080AC	TDK
2	C3, C9	Capacitor, ceramic, 22 nF, 50 V, 10%, X7R, 0603	C0603C223K5RACTU	Kermet
2	C4, C33	Capacitor, ceramic, 1.0 $\mu$ F, 25 V, 10%, X7R, AEC-Q200, Grade 1, 0805	CGA4J3X7R1H105K125AB	TDK
3	C5, C6, C12	Capacitor, ceramic, 2.2 $\mu$ F, 50 V, 10%, X7R, AEC-Q200, Grade 1, 0805	CGA4J3X7R1H225K125AB	TDK
1	C12	Capacitor, ceramic, 0.22 $\mu$ F, 16 V, 10%, X7R, 0402	GRM155R71C224KA12D	MuRata
2	C10, C11	Capacitor, ceramic, 2.2 $\mu$ F, 10 V, 10%, X7R, 0805	C0805C225K8RACTU	Kermet
4	C13, C22, C23, C31	Capacitor, ceramic, 10 $\mu$ F, 50 V, 10%, AEC-Q200, Grade 1, 1210	CGA6P3X7S1H106K250AE	TDK
0	C14	Not used		
1	C15	Capacitor, ceramic, 10 $\mu$ F, 50 V, 10%, X7S, AEC-Q200 Grade 1, 1210	CGA6P3X7S1H106K250AB	TDK
1	C16	Capacitor, ceramic, 0.1 $\mu$ F, 50 V, $\pm$ 10%, X7R, AEC-Q200 Grade 1, 0805	CEU4J2X7R1H104K125AE	TDK
0	C17, C18, C19	Deleted from the design		
1	C20	Capacitor, ceramic, 0.033 $\mu$ F, 50 V, 5%, X7R, 0603	06035C333JAT2A	AVX
1	C21	Capacitor, ceramic, 100 pF, 100 V, 5%, NP0, AEC-Q200 Grade 1, 0603	GCM1885C2A101JA16D	MuRata
1	C24, C34	Capacitor, ceramic, 2.2 $\mu$ F, 100 V, $\pm$ 10%, X7R, AEC-Q200 Grade 1, 1210	CGA6N3X7R2A225K230AB	TDK
5	C25, C26, C27, C28, C29	Capacitor, ceramic, 10 $\mu$ F, 50 V, $\pm$ 10%, X7R, 1210	GRM32ER71H106KA12L	MuRata
1	C30	Capacitor, ceramic, 0.22 $\mu$ F, 25 V, $\pm$ 10%, X7R, AEC-Q200 Grade 1, 0603	GCM188R71E224KA55D	Murata
1	C32	Capacitor, ceramic, 1200 pF, 100 V, $\pm$ 5%, C0G/NP0, 0603	GRM1885C2A122JA01D	MuRata
1	C35	Capacitor, ceramic, 0.01 $\mu$ F, 50 V, 5%, C0G/NP0, AEC-Q200 Grade 1, 0603	CGA3E2C0G1H103J080AA	TDK
1	C36	Capacitor, ceramic, 1 $\mu$ F, 16 V, 20%, X7R, AEC-Q200 Grade 1, 0603	GCM188R71C105MA64D	Murata
1	C37	Capacitor, 100 pF, 50 V, $\pm$ 1%, C0G/NP0, 0603	C0603C101F5GACTU	Kermet
0	C14	Not used		
0	C7, C17, C18, C19	Deleted from the design		
1	D1	Diode, TVS, 5 V, bidirectional, SOD-323	PESD5V0L1BA,115	NXP Semiconductor
2	D2, D4	Diode, Schottky 40 V, 1 A Surface Mount SMA	CMSH1-40M TR13	Diodes, Inc.
0	D3	Not used		
1	D5	Diode, Zener, 6.2 V, 150 mW, SOD-523F	CZRU52C6V2	Comchip Technology
1	D6	Diode, Schottky, 60 V, 3 A, AEC-Q101, SMA	B360AM-13-F	Diodes Inc.
1	D7	Diode, TVS, Bi, 36 V, SMB	SMBJ36CA-13-F	Diodes Inc.

**Table 9-1. UCC28782EVM-030 List of Materials (continued)**

Quantity	Designator	Description	Part Number	Manufacturer
4	J1, J2, J3, J4	Header, 100mil, 1pos, Gold, TH	TSW-101-07-G-S	Samtec
1	L1	Coupled inductor, 1.5 $\mu$ H, 17.5 A, 0.012 $\Omega$ , SMD	7448700015	Wurth Elektronik
1	L2	Coupled inductor, 11 $\mu$ H, 2.5 A, 0.03 $\Omega$ , SMD	744273102	Wurth Elektronik
1	L3	Not used		
2	P1, P2	TERM BLOCK HDR 2POS 90DEG 5MM	691313710002	Wurth Elektronik
1	Plug for P1 or P2	Term Block 2Pos Plug for P1 or P2	691352710002	Wurth Elektronik
1	P3	TERM BLOCK HDR 3POS 90DEG 5MM	691313710003	Wurth Elektronik
1	Plug for P3	Term Block 3Pos Plug for P3	691352710003	Wurth Elektronik
1	Q1	Transistor, NPN, 40 V, 0.6 A, AEC-Q101, SOT-23	SMBT2222AE6327HTSA1	Infineon Technologies
0	Q1	Q1 second source	MMBT2222A-7-F	Diodes Incorporated
1	Q2	MOSFET, N-CH, 60 V, 50 A, SO-8FL	NVMFS5C673NLWFAFT1G	ON Semi
1	R1, R12	Resistor, 16.5 k $\Omega$ , 1%, 0.125 W, AEC-Q200 Grade 0, 0805	CRCW080516K5FKEA	Vishay-Dale
1	R4	Not used		
1	R5	Resistor, 549 $\Omega$ , 5%, 0.125 W, AEC-Q200 Grade 0, 0805	CRCW0805549RFKEA	Vishay-Dale
1	R6	Resistor, 6.34 k $\Omega$ , 1%, 0.125 W, AEC-Q200 Grade 0, 0805	CRCW08056K34FKEA	Vishay-Dale
1	R7, R10	Resistor, 1.0 k $\Omega$ , 5%, 0.125 W, AEC-Q200 Grade 0, 0805	CRCW08051K00JNEA	Vishay-Dale
1	R8, R13	Resistor, 51 $\Omega$ , 0.1%, 0.125 W, 0805	RG2012P-510-B-T5	Susumu Co Ltd
1	R9	Resistor, 1.00 k $\Omega$ , 1%, 0.1 W, AEC-Q200 Grade 0, 0603	CRCW06031K00FKEA	Yageo America
1	R11	Resistor, 49.9 k $\Omega$ , 1%, 0.125 W, AEC-Q200 Grade 0, 0805	CRCW080549K9FKEB	Vishay-Dale
1	R14	Resistor, 30.1 k $\Omega$ , 1%, 0.1 W, AEC-Q200 Grade 0, 0603	CRCW060330K1FKEA	Vishay-Dale
1	R15	Resistor, 10.0 $\Omega$ , 1%, 0.1 W, AEC-Q200 Grade 0, 0603	CRCW060310R0FKEA	Vishay-Dale
1	R16	Resistor, 34.0 k $\Omega$ , 1%, 0.1 W, AEC-Q200 Grade 0, 0603	CRCW060334K0FKEA	Vishay-Dale
1	R17	Resistor, 100 $\Omega$ , 1%, 0.1 W, AEC-Q200 Grade 0, 0603	CRCW0603100RFKEA	Vishay-Dale
1	R18	Resistor, 0.01 $\Omega$ , 1%, 1 W, 1508	RL3720WT-R010-F	Susumu Co Ltd
1	R19	Resistor, 2.32 k $\Omega$ , 1%, 0.1 W, AEC-Q200 Grade 0, 0603	CRCW06032K32FKEA	Vishay-Dale
1	R20	Resistor, 51.0 k $\Omega$ , 1%, 0.1 W, 0603	RC0603FR-0751KL	Yageo
1	R21	Resistor, 9.09 k $\Omega$ , 1%, 0.1 W, AEC-Q200 Grade 0, 0603	CRCW06039K09FKEA	Vishay-Dale
1	R22	Resistor, 3.48 k $\Omega$ , 1%, 0.1 W, AEC-Q200 Grade 0, 0603	CRCW06033K48FKEA	Vishay-Dale
1	R23	Resistor, 0 $\Omega$ , 1%, 0.25 W, AEC-Q200 Grade 0, 1206	CRCW12060000Z0EA	Vishay-Dale
0	R2, R3	Not used		
1	T1	Transformer, 1:1.67, 0.045 $\Omega$ Pri, 0.122- $\Omega$ Sec, 16.5 $\mu$ H	750319177r02	Wurth Electronik
1	U1	Open Loop LLC Transformer Driver for Isolated Bias Supplies	UCC25800AQDGNRQ1	Texas Instruments
1	U2, U3	Programmable Shunt Regulator with Optimized Reference Current, DBZ0003A (SOT-23-3)	ATL431LIBQDBZRQ1	Texas Instruments
1	U4	2.2-MHz Wide VIN 65-V Non-synchronous Boost/SEPIC/Flyback Controller with Dual Random Spread Spectrum, WSON12	LM51561QDSSRQ1	Texas Instruments

## 10 Revision History

<b>Changes from Revision * (February 2021) to Revision A (October 2021)</b>	<b>Page</b>
• Corrected D2 and D4 part number, description and vendor.....	18
• Updated U1 part number.....	18

---

## IMPORTANT NOTICE AND DISCLAIMER

TI PROVIDES TECHNICAL AND RELIABILITY DATA (INCLUDING DATA SHEETS), DESIGN RESOURCES (INCLUDING REFERENCE DESIGNS), APPLICATION OR OTHER DESIGN ADVICE, WEB TOOLS, SAFETY INFORMATION, AND OTHER RESOURCES "AS IS" AND WITH ALL FAULTS, AND DISCLAIMS ALL WARRANTIES, EXPRESS AND IMPLIED, INCLUDING WITHOUT LIMITATION ANY IMPLIED WARRANTIES OF MERCHANTABILITY, FITNESS FOR A PARTICULAR PURPOSE OR NON-INFRINGEMENT OF THIRD PARTY INTELLECTUAL PROPERTY RIGHTS.

These resources are intended for skilled developers designing with TI products. You are solely responsible for (1) selecting the appropriate TI products for your application, (2) designing, validating and testing your application, and (3) ensuring your application meets applicable standards, and any other safety, security, regulatory or other requirements.

These resources are subject to change without notice. TI grants you permission to use these resources only for development of an application that uses the TI products described in the resource. Other reproduction and display of these resources is prohibited. No license is granted to any other TI intellectual property right or to any third party intellectual property right. TI disclaims responsibility for, and you will fully indemnify TI and its representatives against, any claims, damages, costs, losses, and liabilities arising out of your use of these resources.

TI's products are provided subject to [TI's Terms of Sale](#) or other applicable terms available either on [ti.com](http://ti.com) or provided in conjunction with such TI products. TI's provision of these resources does not expand or otherwise alter TI's applicable warranties or warranty disclaimers for TI products.

TI objects to and rejects any additional or different terms you may have proposed.

Mailing Address: Texas Instruments, Post Office Box 655303, Dallas, Texas 75265  
Copyright © 2022, Texas Instruments Incorporated