

## BiCMOS MIXER W/ INTEGRATED LO AMPLIFIER, 700 - 1500 MHz



### Typical Applications

The HMC686LP4(E) is Ideal for:

- Cellular/3G & LTE/WiMAX/4G
- Basestations & Repeaters
- GSM, CDMA & OFDM
- Transmitters and Receivers

### Features

- High Input IP3: +34 dBm
- 7.5 dB Conversion Loss @ 0 dBm LO
- Optimized to High Side LO Input for 0.7 - 1.1 GHz RF Band
- Optimized to Low Side LO Input for 1.4 - 1.5 GHz RF Band
- Adjustable Supply Current
- 24 Lead 4x4mm SMT Package: 16mm<sup>2</sup>

### Functional Diagram



### General Description

The HMC686LP4(E) is a high dynamic range passive MMIC mixer with integrated LO amplifier in a 4x4 SMT QFN package covering 0.7 to 1.1 GHz. Excellent input IP3 performance of +34 dBm for down conversion is provided for 3G & 4G GSM/CDMA applications at an LO drive of 0 dBm. With an input 1 dB compression of +25 dBm, the RF port will accept a wide range of input signal levels. Conversion loss is 7.5 dB typical. The DC to 500 MHz IF frequency response will satisfy GSM/CDMA transmit or receive frequency plans. The HMC686LP4(E) is optimized to high side LO frequency plans for 0.7 - 1.1 GHz RF Band and is pin for pin compatible with the HMC684LP4(E) which is a 0.7 - 1.0 GHz converter optimized for low side LO. The HMC686LP4(E) is optimized to low side LO frequency plans for 1.4 - 1.5 GHz RF LTE band applications.

### Electrical Specifications, $T_A = +25^\circ C$ , LO = 0 dBm, Vcc1, 2, 3, = +5V

Nominal Supply	I <sub>cc</sub> = 105 mA [1]			I <sub>cc</sub> = 80 mA [1]	I <sub>cc</sub> = 60 mA [1]	I <sub>cc</sub> = 120mA [2]			Units
	Min.	Typ.	Max.	Typ.	Typ.	Min.	Typ.	Max.	
Frequency Range, RF	0.7 - 1.1					1.4 - 1.5			GHz
Frequency Range, LO	0.85 - 1.25					1.1 - 1.5			GHz
LO Injection Type	High Side					Low Side			
Frequency Range, IF	DC to 500					50 - 250			MHz
Conversion Loss		7.5	9.5	7.5	7.5		8	10	dB
Noise Figure (SSB)		7.5		7.5	7.5		8		dB
LO to RF Isolation	18	24		26	28	20	36		dB
LO to IF Isolation	30	41		41	42	28	39		dB
RF to IF Isolation	27	36		36	35	27	38		dB
IP3 (Input)		34		32.5	31.5		32		dBm
1 dB Compression (Input)		25		24.5	23.5		25		dBm
LO Drive Input Level (Typical)	-3 to +3			-3 to +3	-3 to +3	-3 to +3			dBm
Gate Bias Voltage G_BIAS		3.5		3.5	3.5		2.5		V
Supply Current I <sub>cc</sub> Total		105	125	80	60		120	140	mA

[1] Unless otherwise noted all measurements performed for 0.7 - 1.1 GHz RF band as downconverter with high side LO & IF = 150 MHz, I<sub>cc</sub> = 105 mA, G\_Bias = 3.5 V

[2] Unless otherwise noted all measurements performed for 1.4 - 1.5 GHz RF LTE band as downconverter with low side LO & IF = 140 MHz



**BiCMOS MIXER W/ INTEGRATED LO AMPLIFIER, 700 - 1500 MHz**

**0.7 - 1.1 GHz RF Band Performance**

**Conversion Gain vs. Temperature**

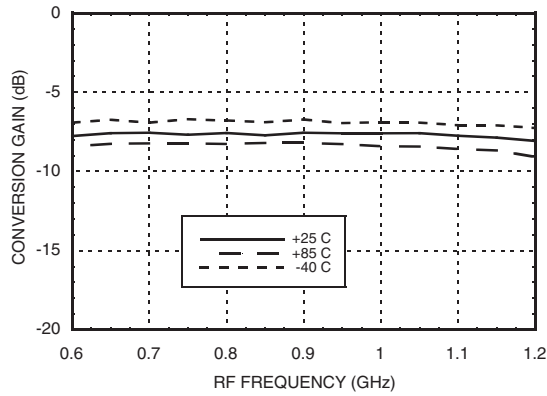

**Isolation**



**Conversion Gain vs. LO Drive**

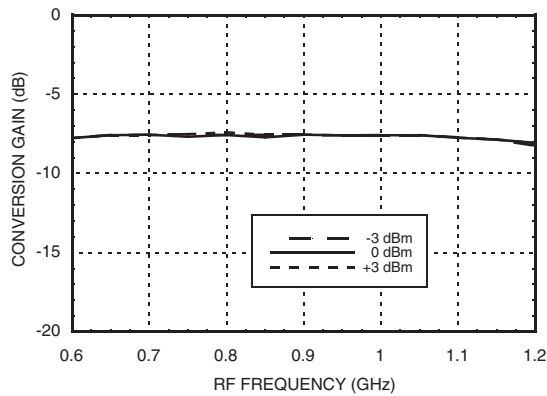

**Return Loss**



**IF Bandwidth (LO = 1.1 GHz)**

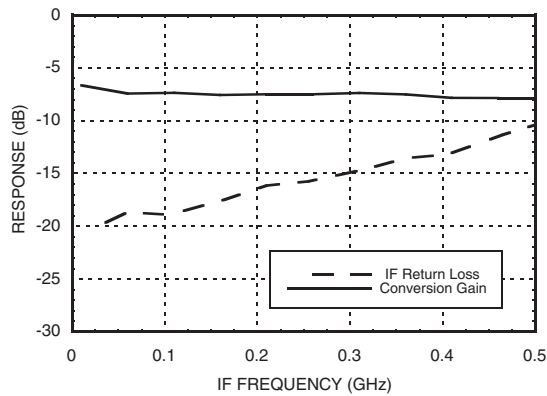

**Input P1dB vs. Temperature**

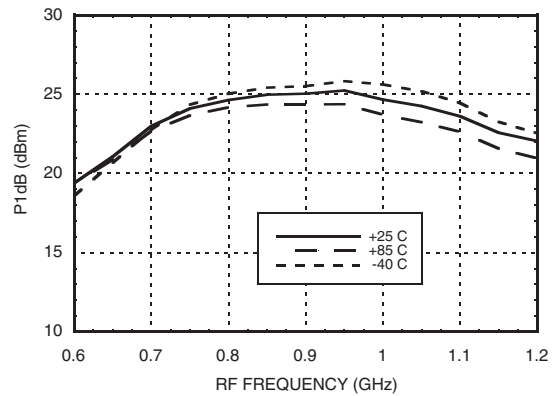

Information furnished by Analog Devices is believed to be accurate and reliable. However, no responsibility is assumed by Analog Devices for its use, nor for any infringements of patents or other rights of third parties that may result from its use. Specifications subject to change without notice. No license is granted by implication or otherwise under any patent or patent rights of Analog Devices. Trademarks and registered trademarks are the property of their respective owners.

For price, delivery, and to place orders: Analog Devices, Inc., One Technology Way, P.O. Box 9106, Norwood, MA 02062-9106 Phone: 781-329-4700 • Order online at [www.analog.com](http://www.analog.com) Application Support: Phone: 1-800-ANALOG-D



**0.7 - 1.1 GHz RF Band Performance**

**Input IP3 vs. LO Drive <sup>[1]</sup>**

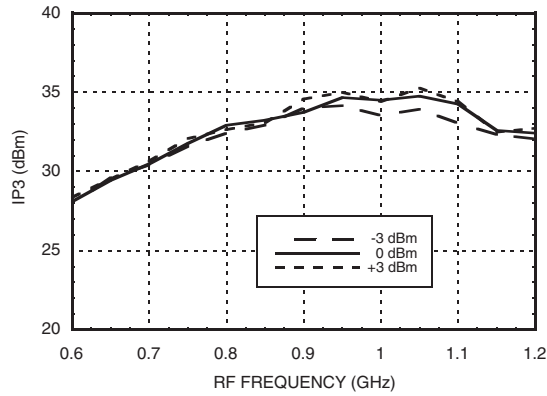

**Input IP3 vs. Temperature <sup>[1]</sup>**

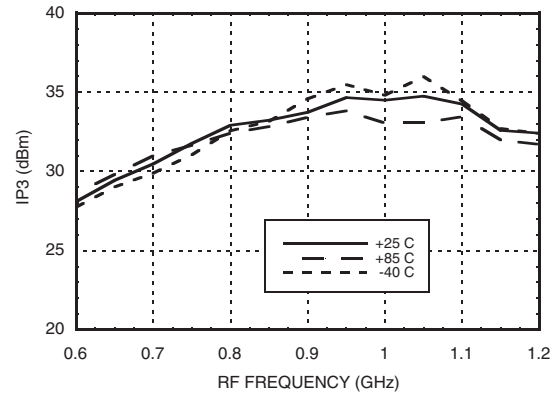

**-2RF +2LO Response vs. Temperature <sup>[2]</sup>**

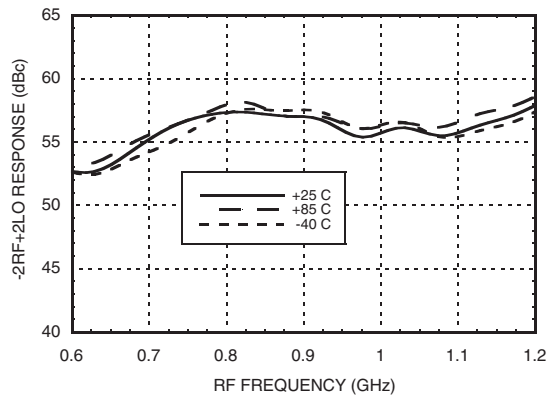

**-2RF +2LO Response vs. LO Drive <sup>[2]</sup>**

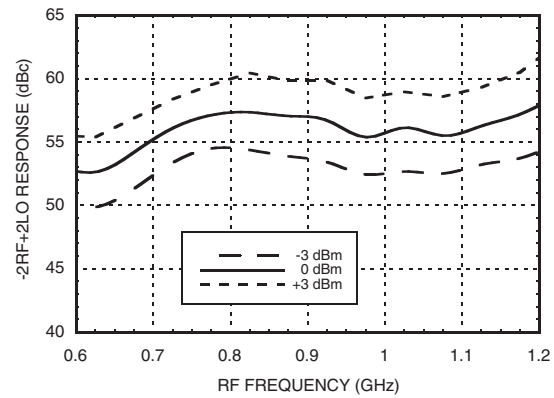

**-3RF +3LO Response vs. Temperature <sup>[2]</sup>**



**-3RF +3LO Response vs. LO Drive <sup>[2]</sup>**

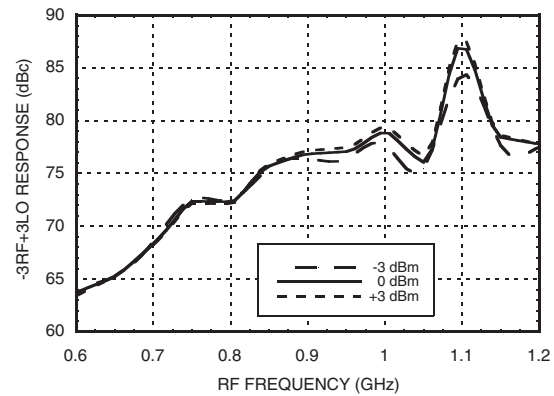

[1] Two-tone input power = +9 dBm each tone, 1 MHz spacing. [2] Referenced to RF Input power at 0 dBm

Information furnished by Analog Devices is believed to be accurate and reliable. However, no responsibility is assumed by Analog Devices for its use, nor for any infringements of patents or other rights of third parties that may result from its use. Specifications subject to change without notice. No license is granted by implication or otherwise under any patent or patent rights of Analog Devices. Trademarks and registered trademarks are the property of their respective owners.

For price, delivery, and to place orders: Analog Devices, Inc., One Technology Way, P.O. Box 9106, Norwood, MA 02062-9106 Phone: 781-329-4700 • Order online at [www.analog.com](http://www.analog.com) Application Support: Phone: 1-800-ANALOG-D



**BiCMOS MIXER W/ INTEGRATED LO AMPLIFIER, 700 - 1500 MHz**

**0.7 - 1.1 GHz RF Band Performance for Low Power Consumption**

**Conversion Gain vs. G\_Bias Voltage**



**Input IP3 vs. G\_Bias Voltage [1]**

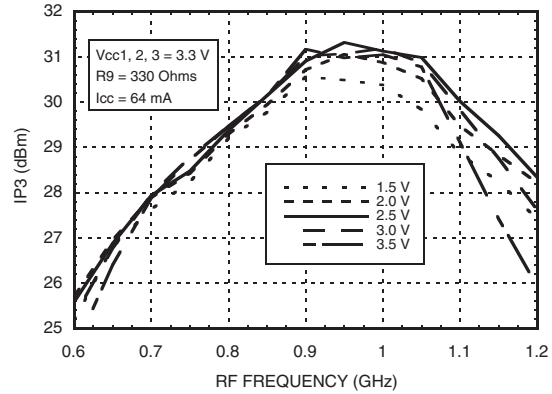

**Conversion Gain vs. G\_Bias Voltage**



**Input IP3 vs. G\_Bias Voltage [1]**

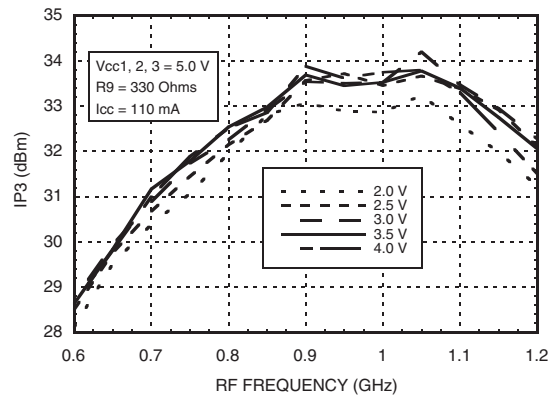

**Conversion Gain vs. Icc**

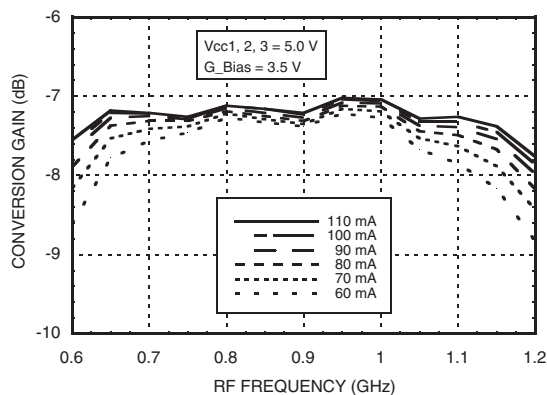

**Input IP3 vs. Icc [1]**

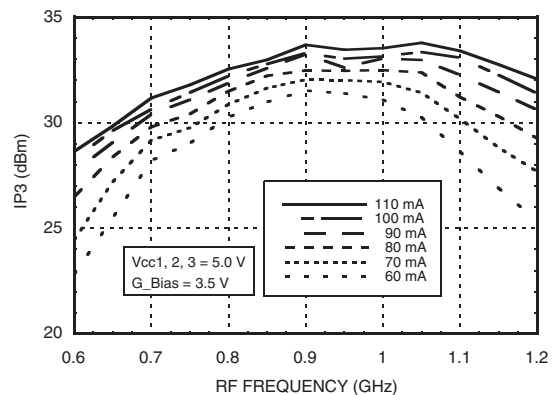

[1] Two-tone input power = +9 dBm each tone, 1 MHz spacing

Information furnished by Analog Devices is believed to be accurate and reliable. However, no responsibility is assumed by Analog Devices for its use, nor for any infringements of patents or other rights of third parties that may result from its use. Specifications subject to change without notice. No license is granted by implication or otherwise under any patent or patent rights of Analog Devices. Trademarks and registered trademarks are the property of their respective owners.

For price, delivery, and to place orders: Analog Devices, Inc., One Technology Way, P.O. Box 9106, Norwood, MA 02062-9106 Phone: 781-329-4700 • Order online at [www.analog.com](http://www.analog.com) Application Support: Phone: 1-800-ANALOG-D



**BiCMOS MIXER W/ INTEGRATED LO AMPLIFIER, 700 - 1500 MHz**

**0.7 - 1.1 GHz RF Band Performance for Low Power Consumption**

**Conversion Gain vs. Temperature,  $I_{cc} = 60 \text{ mA}$**

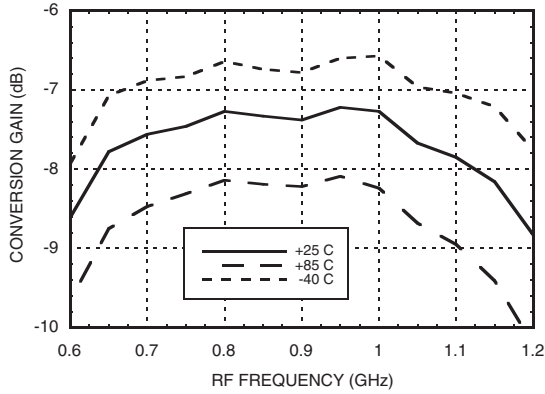

**Input IP3 vs. Temperature,  $I_{cc} = 60 \text{ mA}$  [1]**

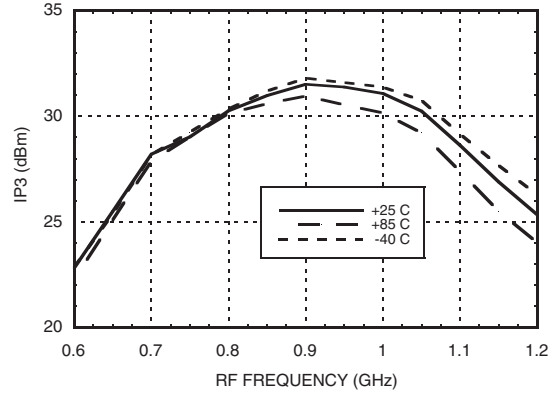

**$I_{cc}$  vs.  $R_9$**

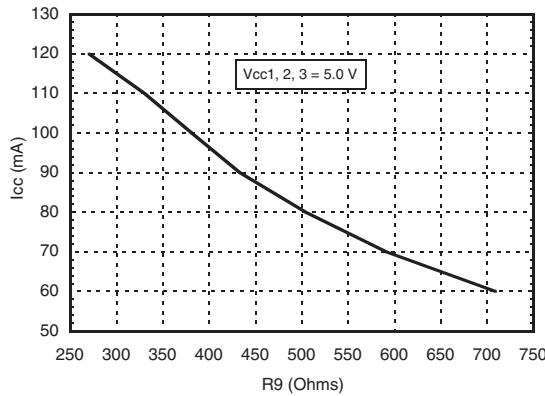

**Typical Upconverter Performance**

**Conversion Gain vs. LO Drive**

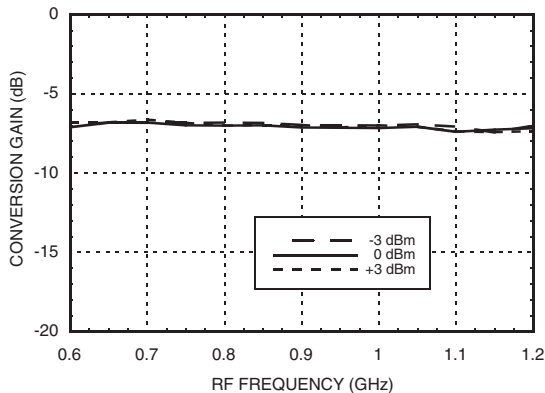

**Input IP3 vs. LO Drive [1]**

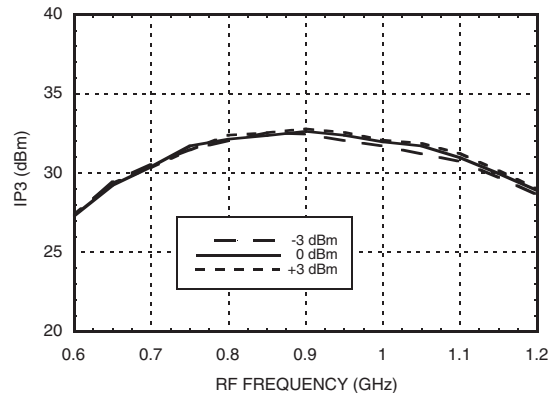

[1] Two-tone input power = +9 dBm each tone, 1 MHz spacing

Information furnished by Analog Devices is believed to be accurate and reliable. However, no responsibility is assumed by Analog Devices for its use, nor for any infringements of patents or other rights of third parties that may result from its use. Specifications subject to change without notice. No license is granted by implication or otherwise under any patent or patent rights of Analog Devices. Trademarks and registered trademarks are the property of their respective owners.

For price, delivery, and to place orders: Analog Devices, Inc., One Technology Way, P.O. Box 9106, Norwood, MA 02062-9106 Phone: 781-329-4700 • Order online at [www.analog.com](http://www.analog.com) Application Support: Phone: 1-800-ANALOG-D



**BiCMOS MIXER W/ INTEGRATED LO AMPLIFIER, 700 - 1500 MHz**

**0.7 - 1.1 GHz RF Band Performance for Narrowband High IP3 Upconverter Tune [1]**

**Conversion Gain and IP3, G\_BIAS = 1.5 [2][3]**

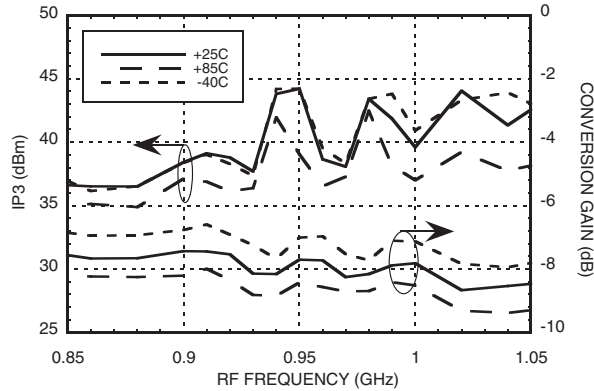

**Conversion Gain and IP3, G\_BIAS = 2.5 [2][3]**

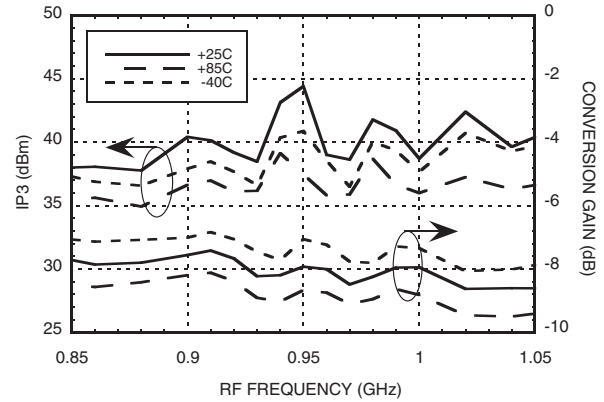

**Conversion Gain and IP3, G\_BIAS = 3.5 [2][3]**

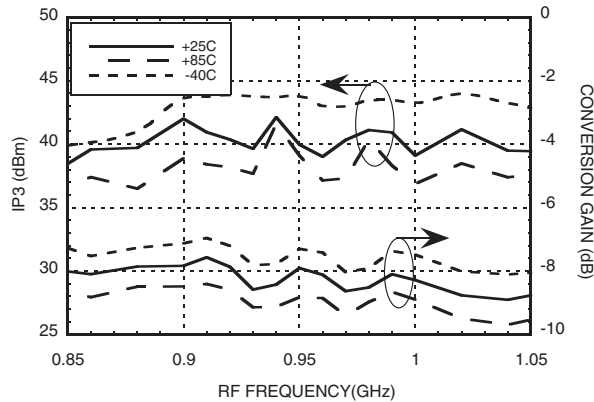

**IP3 vs G\_BIAS, LO = 1060 MHz [2]**

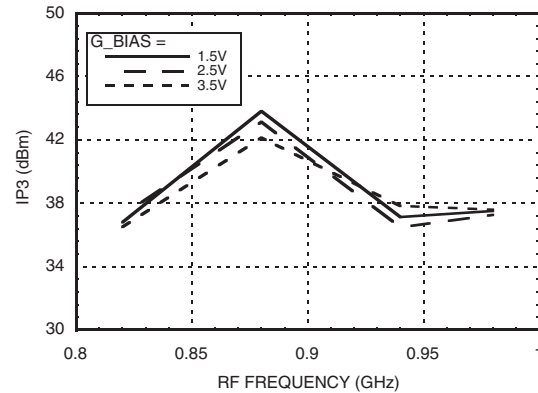

**IP3 vs Temperature, G\_BIAS = 1.5V, LO = 1060 MHz [2]**

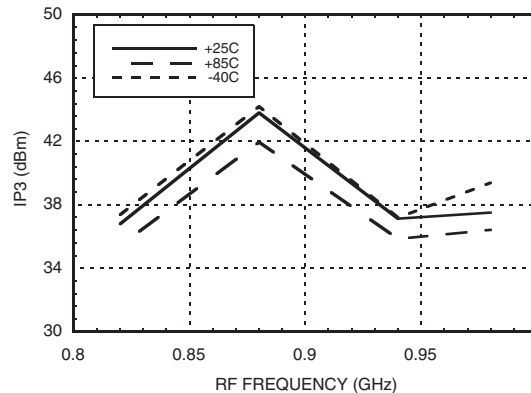

[1] See Narrowband High IP3 Upconverter Tune Evaluation PCB and schematic.

[2] Two-tone input power = +9 dBm each tone, 1 MHz spacing.

[3] IF = 120 MHz



**BiCMOS MIXER W/ INTEGRATED LO AMPLIFIER, 700 - 1500 MHz**

**1.4 - 1.5 GHz RF LTE Band Performance [1]**

**Conversion Gain vs. Temperature [2]**



**Isolation [2]**

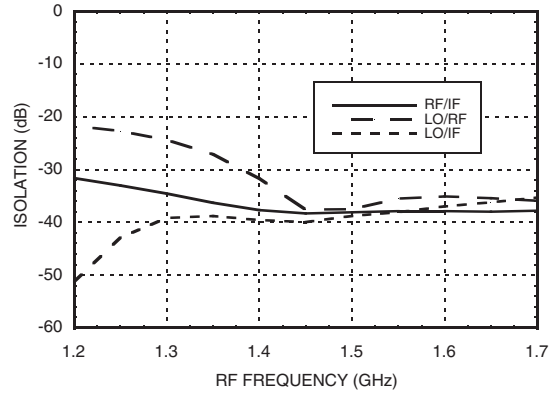

**Conversion Gain vs. LO Drive [2]**

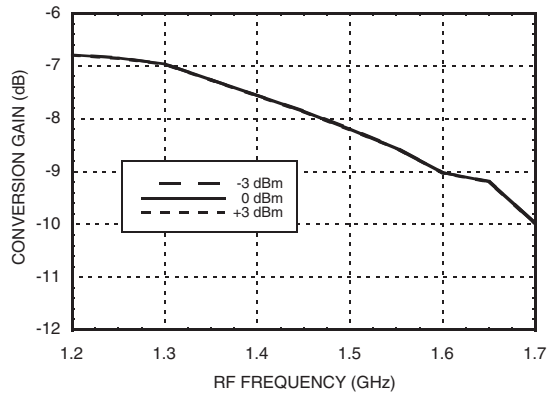

**Return Loss**

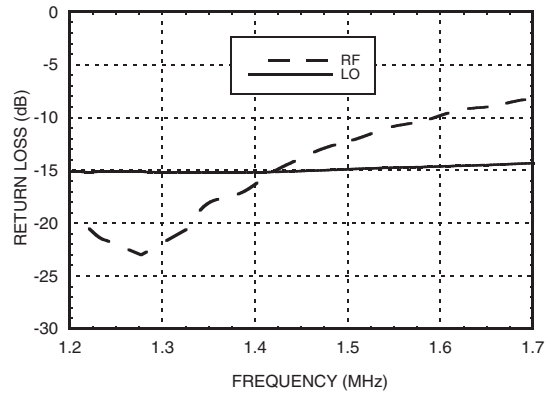

**IF Bandwidth (LO = 1.3 GHz)**

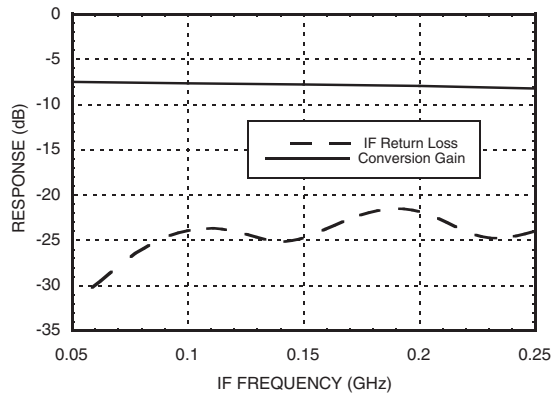

**Input P1dB vs. Temperature [2]**

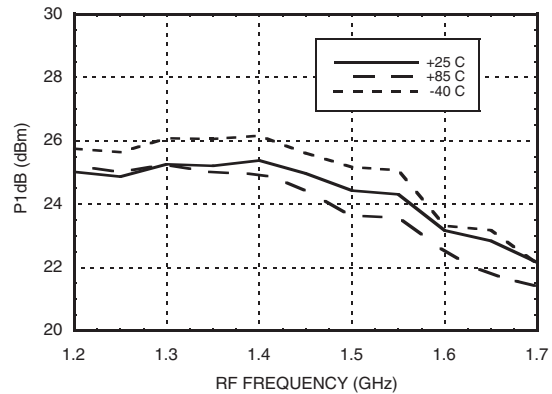

[1] See 1.4 - 1.5 GHz RF LTE Band Evaluation PCB and schematic.

[2] G\_Bias = +2.5V, IF = 140 MHz



**1.4 - 1.5 GHz RF LTE Band Performance [1]**

**Input IP3 vs. LO Drive [2] [3]**

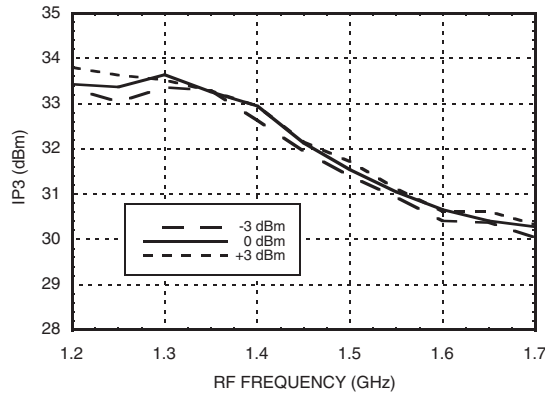

**Input IP3 vs. Temperature [2] [3]**



**+2RF -2LO Response vs. Temperature [2] [4]**

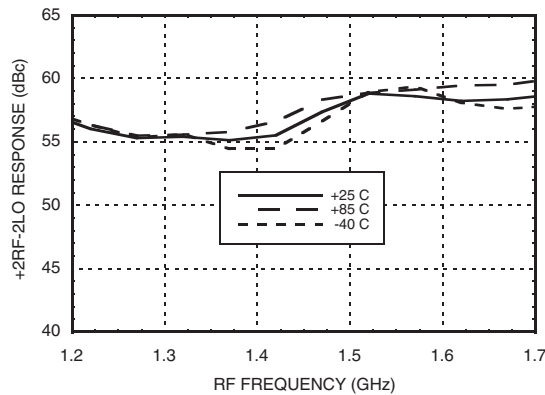

**+2RF -2LO Response vs. LO Drive [2] [4]**



**+3RF -3LO Response vs. Temperature [2] [4]**

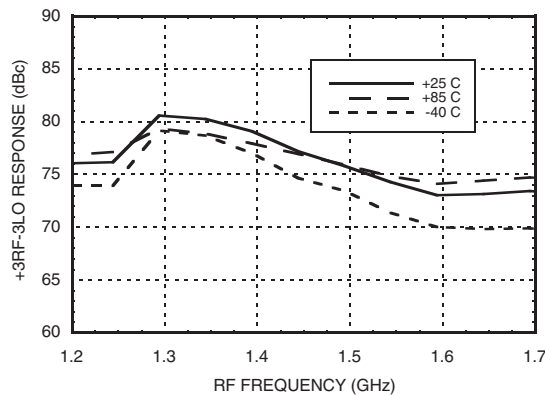

**+3RF -3LO Response vs. LO Drive [2] [4]**



[1] See 1.4 - 1.5 GHz RF LTE Band Evaluation PCB and schematic.

[2] G\_Bias = +2.5V, IF = 140 MHz

[3] Two-tone input power = +9 dBm each tone, 1 MHz spacing

[4] Referenced to RF Input Power at 0 dBm

Information furnished by Analog Devices is believed to be accurate and reliable. However, no responsibility is assumed by Analog Devices for its use, nor for any infringements of patents or other rights of third parties that may result from its use. Specifications subject to change without notice. No license is granted by implication or otherwise under any patent or patent rights of Analog Devices. Trademarks and registered trademarks are the property of their respective owners.

For price, delivery, and to place orders: Analog Devices, Inc., One Technology Way, P.O. Box 9106, Norwood, MA 02062-9106 Phone: 781-329-4700 • Order online at [www.analog.com](http://www.analog.com) Application Support: Phone: 1-800-ANALOG-D





**BiCMOS MIXER W/ INTEGRATED LO AMPLIFIER, 700 - 1500 MHz**

**1.4 - 1.5 GHz RF LTE Band Performance [1]**

**Conversion Gain vs. G\_Bias Voltage**



**Input IP3 vs. G\_Bias Voltage [2]**

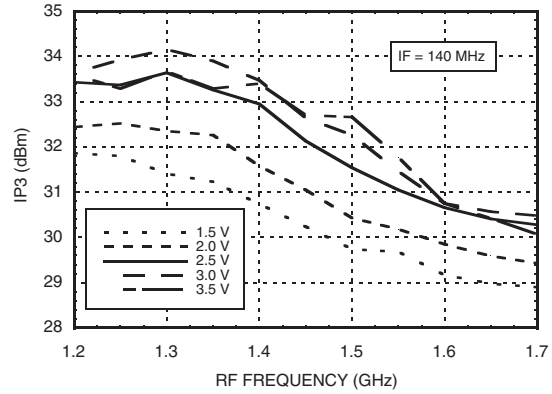

**Conversion Gain vs. IF Frequency**



**Input IP3 vs. IF Frequency [2]**

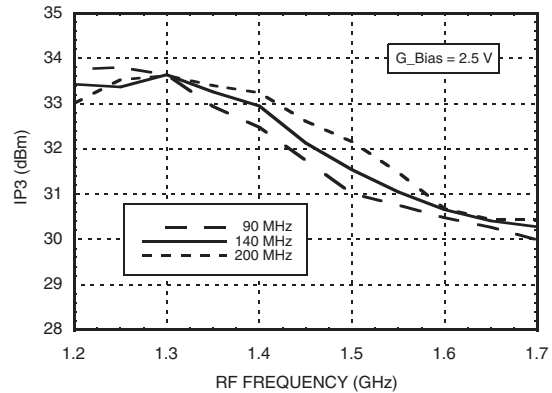

**Upconverter Performance Conversion Gain vs. Temperature [3]**



**Upconverter Performance Input IP3 vs. Temperature [2] [3]**

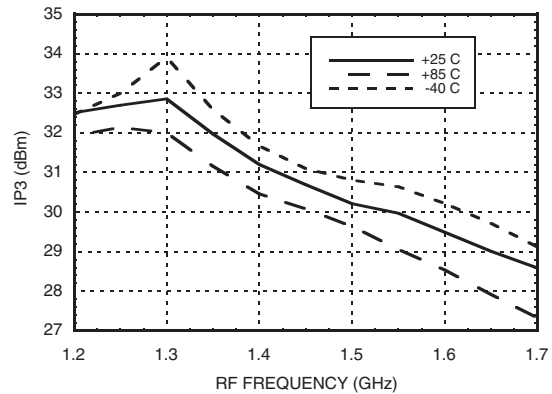

[1] See 1.4 - 1.5 GHz RF LTE Band Evaluation PCB and schematic.

[3] G\_Bias = +2.5V, IF = 140 MHz

[2] Two-tone input power = +9 dBm each tone, 1 MHz spacing

## BiCMOS MIXER W/ INTEGRATED LO AMPLIFIER, 700 - 1500 MHz



### 1.4 - 1.5 GHz RF LTE Band Performance [1]

**Upconverter Performance**  
Conversion Gain vs. LO Drive [2]

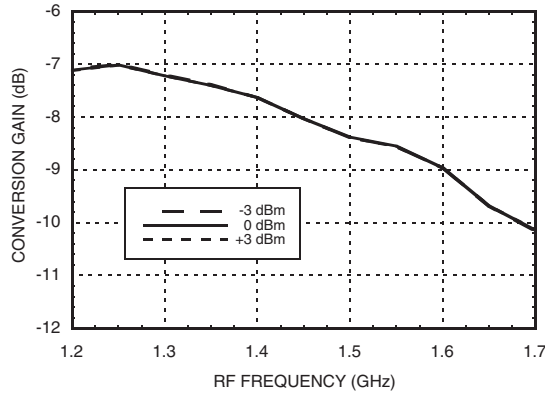

**Upconverter Performance**  
Input IP3 vs. LO Drive [2] [3]

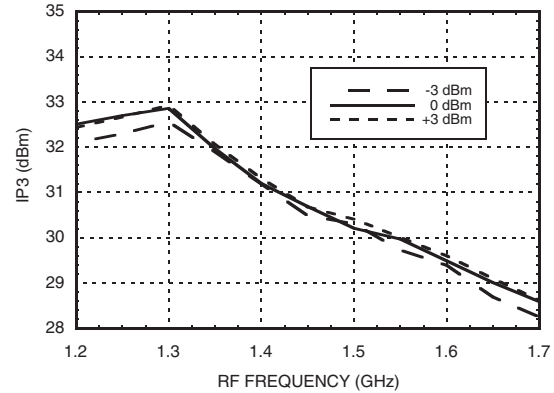

**Harmonics of LO [4]**

LO Freq. (GHz)	nLO Spur @ RF Port			
	1	2	3	4
0.75	28	40	40	39
0.85	25	34	60	33
0.95	23	29	32	31
1.05	23	28	36	26
1.15	26	23	38	34
1.25	33	19	44	34
1.35	39	18	39	38

LO = 0 dBm  
All values in dBc below input LO level measured at RF port

**MxN Spurious @ IF Port [4]**

mRF	nLO				
	0	1	2	3	4
0	xx	41	17	31	40
1	26	0	28	17	46
2	52	50	50	62	58
3	80	66	87	71	87
4	98	97	98	97	98

RF Freq. = 0.9 GHz @ 0 dBm  
LO Freq. = 1.0 GHz @ 0 dBm  
All values in dBc below IF power level (-1RF + 1LO).

### Absolute Maximum Ratings

RF / IF Input (Vcc1,2,3 = +5V)	+23 dBm
LO Drive (Vcc1,2,3 = +5V)	+10 dBm
Vcc1,2,3	+5.5V
Channel Temperature	125 °C
Continuous Pdiss (T = 85°C) (derate 19 mW/°C above 85°C)	0.76 W
Thermal Resistance (channel to ground paddle)	52 °C/W
Storage Temperature	-65 to 150 °C
Operating Temperature	-40 to +85 °C

### Typical Supply Current vs. Vcc

Vcc1,2,3 (V)	Icc Total (mA)
4.75	100
5.00	105
5.25	110

Product will operate over full voltage range shown above.



**ELECTROSTATIC SENSITIVE DEVICE**  
**OBSERVE HANDLING PRECAUTIONS**

- [1] See 1.4 - 1.5 GHz RF LTE Band Evaluation PCB and schematic.
- [2] G\_Bias = +2.5V, IF = 140 MHz
- [3] Two-tone input power = +9 dBm each tone, 1 MHz spacing
- [4] See 0.7 - 1.1 GHz RF Band Evaluation PCB and schematic



### Outline Drawing

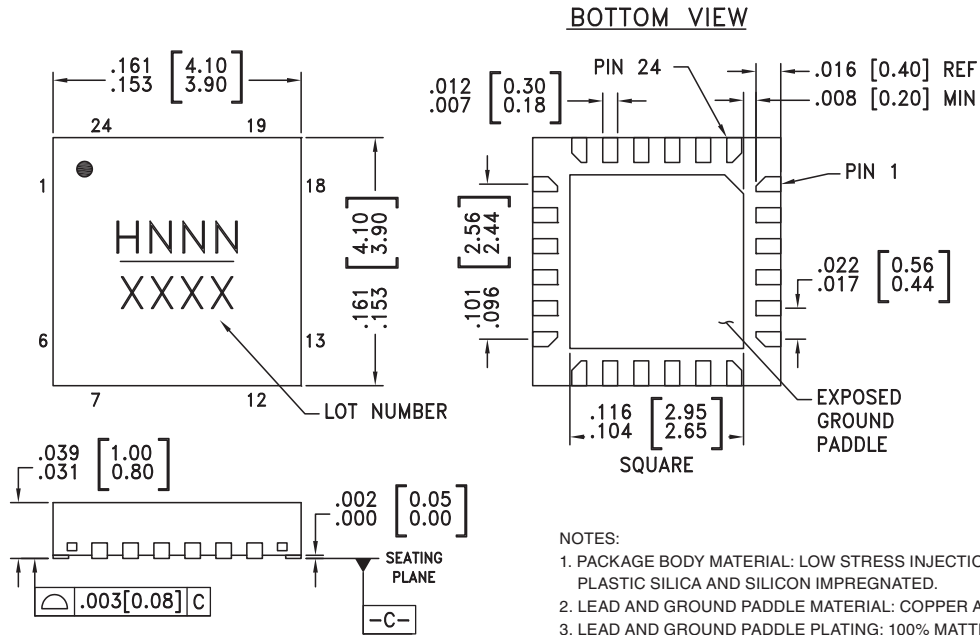

- NOTES:
1. PACKAGE BODY MATERIAL: LOW STRESS INJECTION MOLDED PLASTIC SILICA AND SILICON IMPREGNATED.
  2. LEAD AND GROUND PADDLE MATERIAL: COPPER ALLOY.
  3. LEAD AND GROUND PADDLE PLATING: 100% MATTE TIN.
  4. DIMENSIONS ARE IN INCHES [MILLIMETERS].
  5. LEAD SPACING TOLERANCE IS NON-CUMULATIVE.
  6. PAD BURR LENGTH SHALL BE 0.15mm MAX. PAD BURR HEIGHT SHALL BE 0.25mm MAX.
  7. PACKAGE WARP SHALL NOT EXCEED 0.05mm
  8. ALL GROUND LEADS AND GROUND PADDLE MUST BE SOLDERED TO PCB RF GROUND.
  9. REFER TO HITTITE APPLICATION NOTE FOR SUGGESTED PCB LAND PATTERN.

### Package Information

Part Number	Package Body Material	Lead Finish	MSL Rating	Package Marking <sup>[3]</sup>
HMC686LP4	Low Stress Injection Molded Plastic	Sn/Pb Solder	MSL1 <sup>[1]</sup>	H686 XXXX
HMC686LP4E	RoHS-compliant Low Stress Injection Molded Plastic	100% matte Sn	MSL1 <sup>[2]</sup>	H686 XXXX

[1] Max peak reflow temperature of 235 °C  
 [2] Max peak reflow temperature of 260 °C  
 [3] 4-Digit lot number XXXX

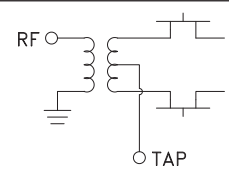
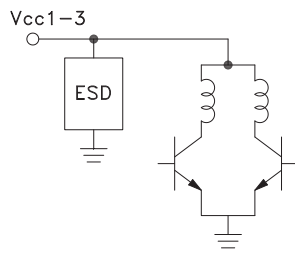
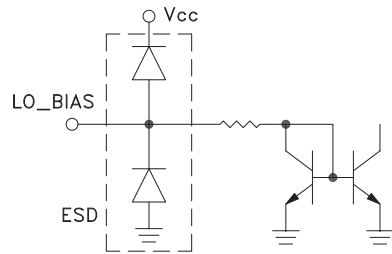
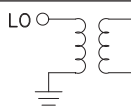
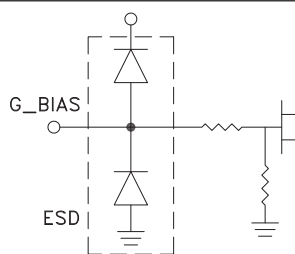
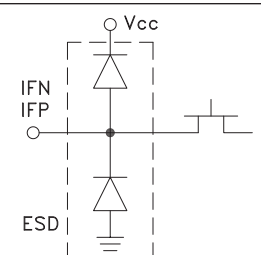

**Pin Descriptions**

Pin Number	Function	Description	Interface Schematic
1, 6, 7, 11 - 14, 18, 20, 23	N/C	No connection. These pins may be connected to RF ground. Performance will not be affected.	
2, 5, 15, 17	GND	Package bottom must be connected to RF/DC ground.	
3	RF	This pin is matched single-ended to 50 Ohms and DC shorted to ground through a balun.	
4	TAP	Center tap of secondary side of the internal RF balun. Short to ground with zero ohms close to the package.	
8, 10, 24	Vcc1, Vcc2, Vcc3	Power supply voltage. See application circuit for required external components.	
9	LO_BIAS	LO buffer current adjustment pin. Adjust the LO buffer current through the external resistor R9 shown in the application circuit (connect 330 Ohms for nominal operation). This adjustment allows for a trade-off between power dissipation and linearity performance of the converter.	
16	LO	This pin is matched single-ended to 50 Ohms and DC shorted to ground through a balun.	
19	G_BIAS	External bias. See application circuit for recommended external components. Apply +3.5V for nominal operation at 5V supply voltage. G_Bias can be set to between 0 and 5Vdc. The G_bias pin has an internal 15K ohm resistance to ground. This adjustment allows for a trade off between conversion loss and linearity performance of the converter (see figures CG, IP3 vs. G-Bias).	
21, 22	IFN, IFP	Differential IF input / output pins matched to differential 50 Ohms. For applications not requiring operation to DC an off chip DC blocking capacitor should be used.	

**BiCMOS MIXER W/ INTEGRATED  
LO AMPLIFIER, 700 - 1500 MHz**

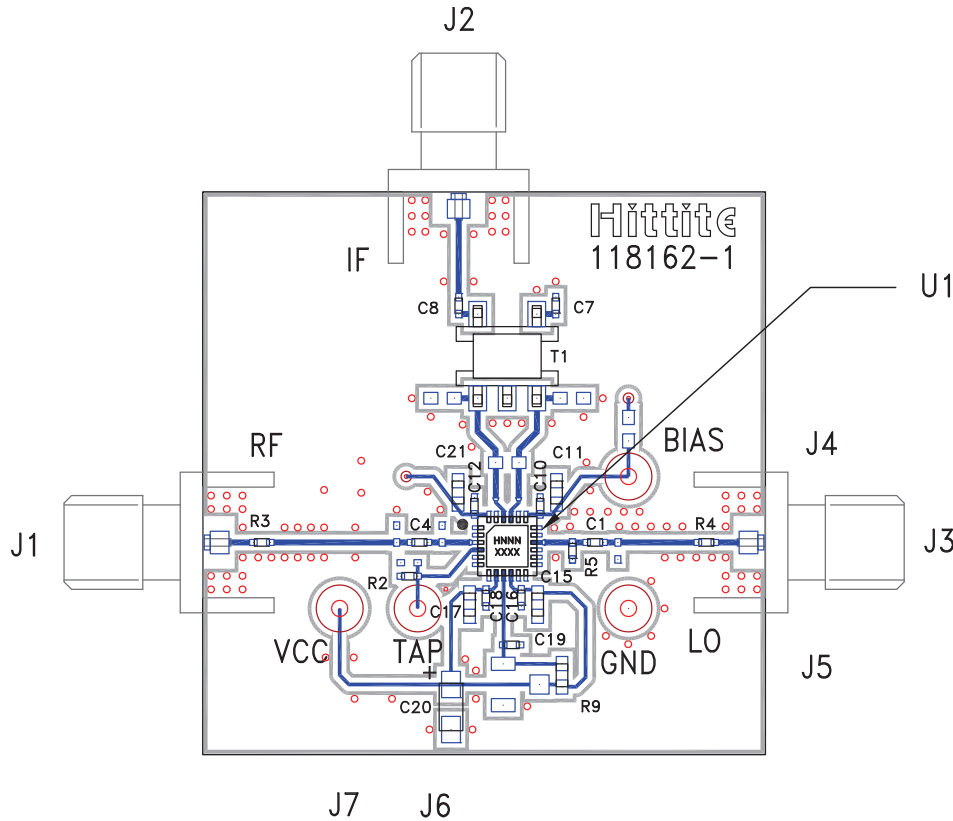

**Evaluation PCB - 0.7 - 1.1 GHz RF Band**



**List of Materials for Evaluation PCB 119936 [1]**

Item	Description
J1 - J3	SMA Connector
J4 - J7	DC Pin
C1, C19	22 pF Capacitor, 0402 Pkg.
C4	6.8 pF Capacitor, 0402 Pkg.
C7, C8	10 nF Capacitor, 0402 Pkg.
C10, C12, C16, C18	1 nF Capacitor, 0402 Pkg.
C11, C15, C17, C21	0.1 μF Capacitor, 0603 Pkg.
C20	4.7 μF Case A, Tantalum
R2 - R4	0 Ohm Resistor, 0402 Pkg.
R5	68 Ohm Resistor, 0402 Pkg.
R9	330 Ohm Resistor, 0603 Pkg.
T1	1:1 Transformer - Tyco MABACT0039
U1	HMC686LP4(E) Downconverter
PCB [2]	118162 Evaluation PCB

The circuit board used in the application should use RF circuit design techniques. Signal lines should have 50 Ohm impedance while the package ground leads and exposed paddle should be connected directly to the ground plane similar to that shown. A sufficient number of via holes should be used to connect the top and bottom ground planes. The evaluation circuit board shown is available from Hittite upon request.

[1] Reference this number when ordering complete evaluation PCB

[2] Circuit Board Material: Arlon 25R, FR4



**Application Circuit - 0.7 - 1.1 GHz RF Band**

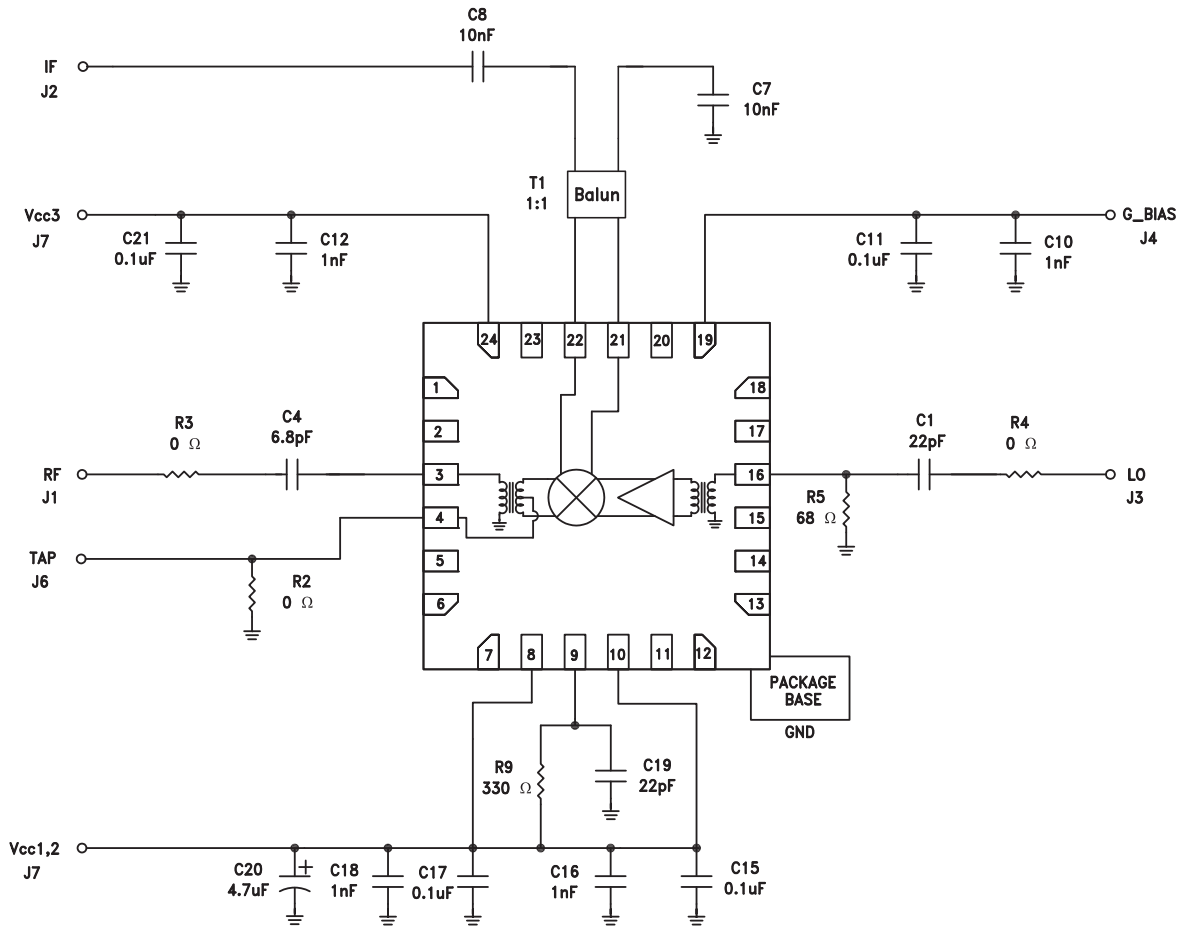

10

MIXERS - SINGLE & DOUBLE BALANCED - SMT

Information furnished by Analog Devices is believed to be accurate and reliable. However, no responsibility is assumed by Analog Devices for its use, nor for any infringements of patents or other rights of third parties that may result from its use. Specifications subject to change without notice. No license is granted by implication or otherwise under any patent or patent rights of Analog Devices. Trademarks and registered trademarks are the property of their respective owners.

For price, delivery, and to place orders: Analog Devices, Inc., One Technology Way, P.O. Box 9106, Norwood, MA 02062-9106 Phone: 781-329-4700 • Order online at [www.analog.com](http://www.analog.com) Application Support: Phone: 1-800-ANALOG-D



**Evaluation PCB - 0.7 - 1.1 GHz RF Band, Narrowband High IP3 Upconverter Tune**

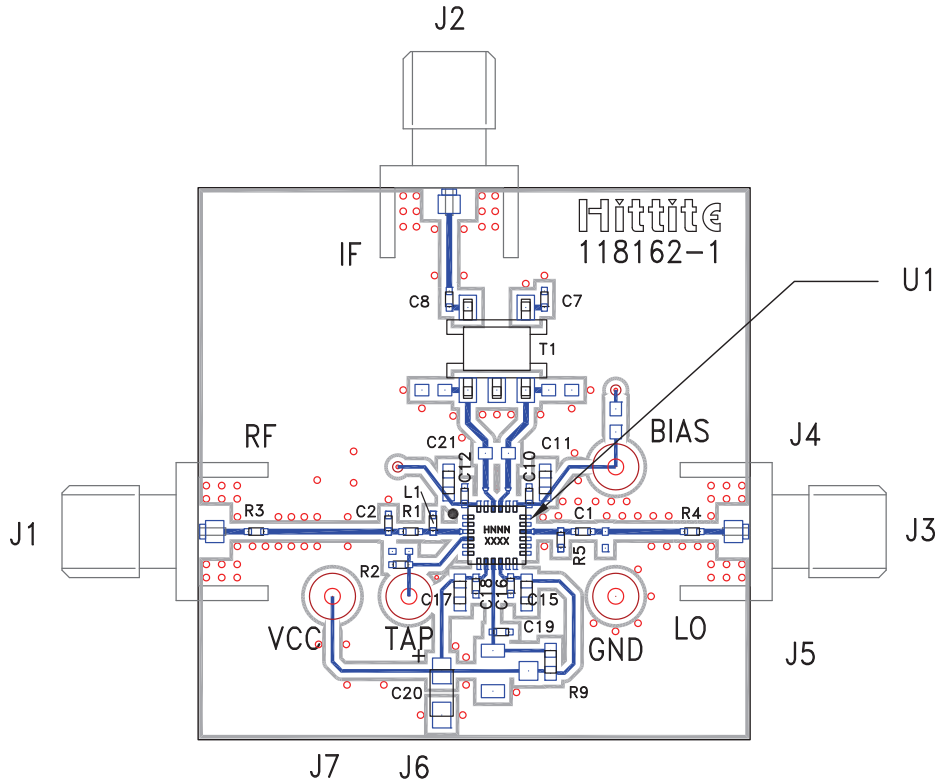

**List of Materials for Evaluation PCB 122410 [1]**

Item	Description
J1 - J3	SMA Connector
J4 - J7	DC Pin
C1, C19	22 pF Capacitor, 0402 Pkg.
C2	4.7 pF Capacitor, 0402 Pkg.
C7, C8	10 nF Capacitor, 0402 Pkg.
C10, C12, C16, C18	1 nF Capacitor, 0402 Pkg.
C11, C15, C17, C21	0.1 μF Capacitor, 0603 Pkg.
C20	4.7 μF Case A, Tantalum
R1	0 Ohm Resistor, 0402 Pkg.
R2 - R4	0 Ohm Resistor, 0402 Pkg.
R5	68 Ohm Resistor, 0402 Pkg.
R9	330 Ohm Resistor, 0603 Pkg.
T1	1:1 Transformer - Tyco MABACT0039
U1	HMC686LP4(E) Downconverter
L1	5.6 nH Ind, 0402 Pkg.
PCB [2]	118162 Evaluation PCB

The circuit board used in the application should use RF circuit design techniques. Signal lines should have 50 Ohm impedance while the package ground leads and exposed paddle should be connected directly to the ground plane similar to that shown. A sufficient number of via holes should be used to connect the top and bottom ground planes. The evaluation circuit board shown is available from Hittite upon request.

[1] Reference this number when ordering complete evaluation PCB

[2] Circuit Board Material: Arlon 25R, FR4

**BiCMOS MIXER W/ INTEGRATED LO AMPLIFIER, 700 - 1500 MHz**



**Application Circuit - 0.7 - 1.1 GHz RF Band, Narrowband High IP3 Upconverter Tune**

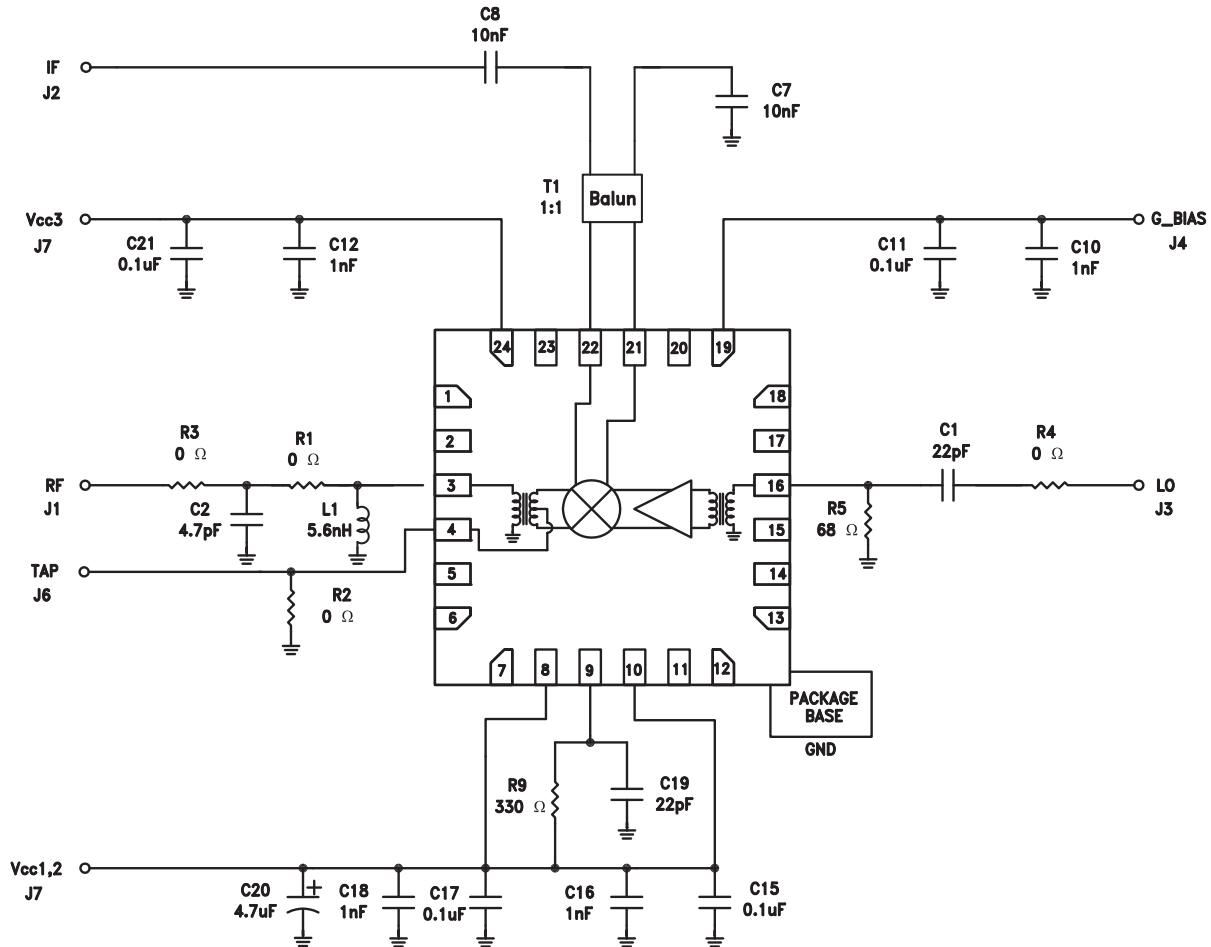

10

MIXERS - SINGLE & DOUBLE BALANCED - SMT

Information furnished by Analog Devices is believed to be accurate and reliable. However, no responsibility is assumed by Analog Devices for its use, nor for any infringements of patents or other rights of third parties that may result from its use. Specifications subject to change without notice. No license is granted by implication or otherwise under any patent or patent rights of Analog Devices. Trademarks and registered trademarks are the property of their respective owners.

For price, delivery, and to place orders: Analog Devices, Inc., One Technology Way, P.O. Box 9106, Norwood, MA 02062-9106 Phone: 781-329-4700 • Order online at [www.analog.com](http://www.analog.com) Application Support: Phone: 1-800-ANALOG-D



**BiCMOS MIXER W/ INTEGRATED LO AMPLIFIER, 700 - 1500 MHz**



**Evaluation PCB - 1.4 - 1.5 GHz RF LTE Band**

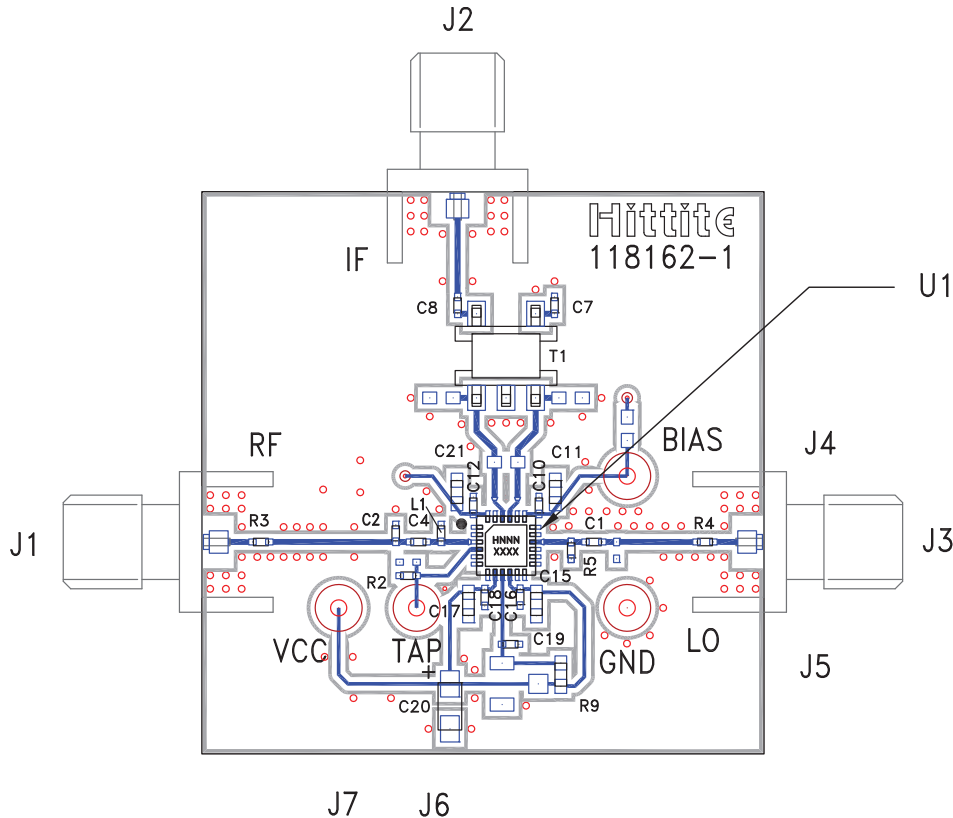

**List of Materials for Evaluation PCB 125658 [1]**

Item	Description
J1 - J3	SMA Connector
J4 - J7	DC Pin
C1, C19	22 pF Capacitor, 0402 Pkg.
C2	2.2 pF Capacitor, 0402 Pkg.
C4	6.8 pF Capacitor, 0402 Pkg.
C7, C8	10 nF Capacitor, 0402 Pkg.
C10, C12, C16, C18	1 nF Capacitor, 0402 Pkg.
C11, C15, C17, C21	0.1 μF Capacitor, 0603 Pkg.
C20	4.7 μF Case A, Tantalum
R2 - R4	0 Ohm Resistor, 0402 Pkg.
R5	68 Ohm Resistor, 0402 Pkg.
R9	270 Ohm Resistor, 0603 Pkg.
T1	1:1 Transformer - Tyco MABACT0039
U1	HMC686LP4(E) Downconverter
L1	7.5 nH Ind, 0402 Pkg.
PCB [2]	118162 Evaluation PCB

The circuit board used in the application should use RF circuit design techniques. Signal lines should have 50 Ohm impedance while the package ground leads and exposed paddle should be connected directly to the ground plane similar to that shown. A sufficient number of via holes should be used to connect the top and bottom ground planes. The evaluation circuit board shown is available from Hittite upon request.

[1] Reference this number when ordering complete evaluation PCB

[2] Circuit Board Material: Arlon 25R, FR4

**BiCMOS MIXER W/ INTEGRATED LO AMPLIFIER, 700 - 1500 MHz**



**Application Circuit - 1.4 - 1.5 GHz RF LTE Band**

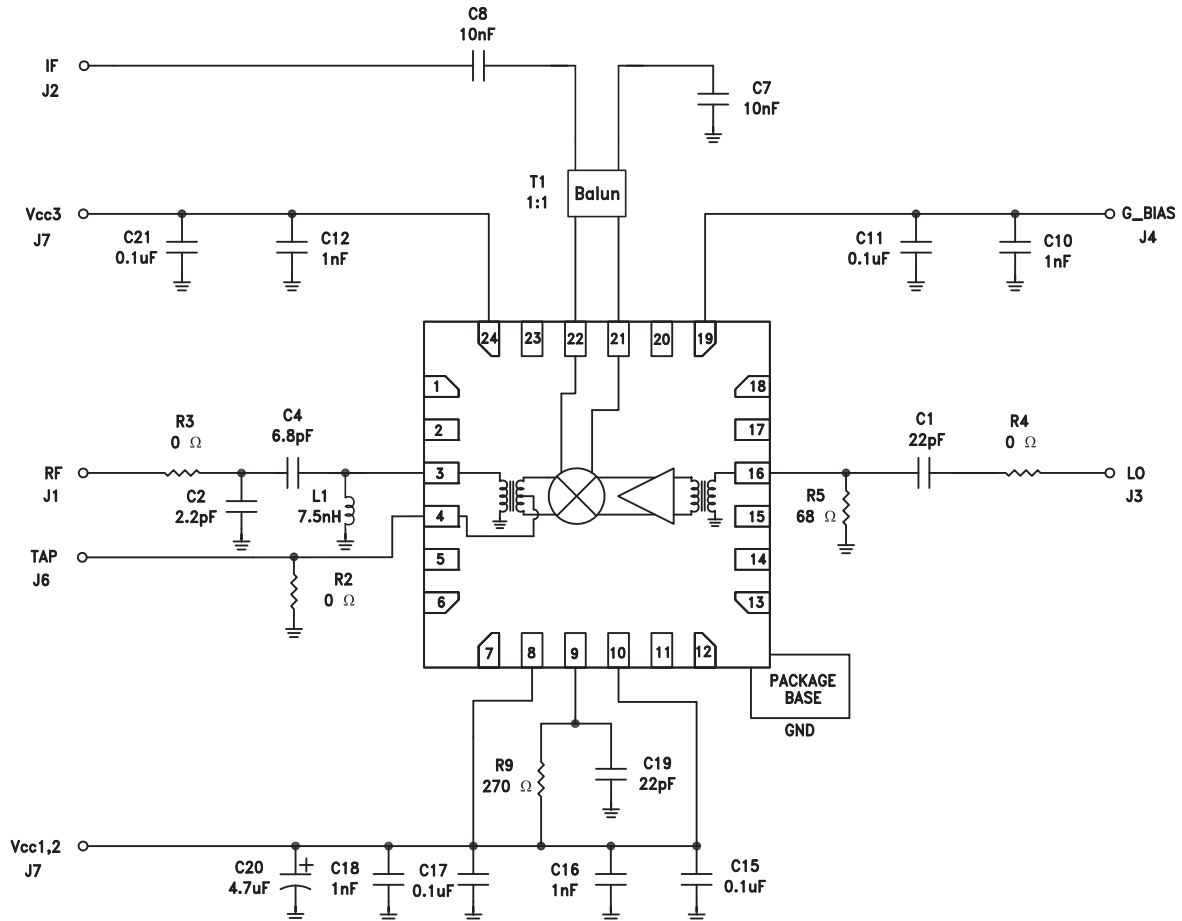

10

MIXERS - SINGLE & DOUBLE BALANCED - SMT

Information furnished by Analog Devices is believed to be accurate and reliable. However, no responsibility is assumed by Analog Devices for its use, nor for any infringements of patents or other rights of third parties that may result from its use. Specifications subject to change without notice. No license is granted by implication or otherwise under any patent or patent rights of Analog Devices. Trademarks and registered trademarks are the property of their respective owners.

For price, delivery, and to place orders: Analog Devices, Inc., One Technology Way, P.O. Box 9106, Norwood, MA 02062-9106 Phone: 781-329-4700 • Order online at [www.analog.com](http://www.analog.com) Application Support: Phone: 1-800-ANALOG-D