

## FEATURES

- 4 differential transmitters**
- 4 differential receivers**
- 2 observation receivers with 2 inputs each**
- Center frequency: 75 MHz to 6000 MHz**
- Maximum receiver bandwidth: 200 MHz**
- Maximum transmitter large signal bandwidth: 200 MHz**
- Maximum transmitter synthesis bandwidth: 450 MHz**
- Maximum observation receiver bandwidth: 450 MHz**
- Fully integrated independent fractional-N radio frequency synthesizers**
- Fully integrated clock synthesizer**
- Multichip phase synchronization for all local oscillators and baseband clocks**
- Support for TDD and FDD applications**
- 24.33 Gbps JESD204B/JESD204C digital interface**

## APPLICATIONS

- 3G/4G/5G TDD and FDD massive MIMO, macro and small cell base stations**

## GENERAL DESCRIPTION

The ADRV9026 is a highly integrated, radio frequency (RF) agile transceiver offering four independently controlled transmitters, dedicated observation receiver inputs for monitoring each transmitter channel, four independently controlled receivers, integrated synthesizers, and digital signal processing functions providing a complete transceiver solution. The device provides the performance demanded by cellular infrastructure applications, such as small cell base station radios, macro 3G/4G/5G systems, and massive multiple in/multiple out (MIMO) base stations.

The receiver subsystem consists of four independent, wide bandwidth, direct conversion receivers with wide dynamic range. The four independent transmitters use a direct conversion modulator resulting in low noise operation with low power consumption. The device also includes two wide bandwidth, time shared, observation path receivers with two inputs each for monitoring transmitter outputs.

The complete transceiver subsystem includes automatic and manual attenuation control, dc offset correction, quadrature error correction (QEC), and digital filtering, eliminating the need for these functions in the digital baseband. Other auxiliary functions such as analog-to-digital converters (ADCs), digital-to-analog converters (DACs), and general-purpose input/outputs (GPIOs) that provide an array of digital control options are also integrated.

To achieve a high level of RF performance, the transceiver includes five fully integrated phase-locked loops (PLLs). Two PLLs provide low noise and low power fractional-N RF synthesis for the transmitter and receiver signal paths. A third fully integrated PLL supports an independent local oscillator (LO) mode for the observation receiver. The fourth PLL generates the clocks needed for the converters and digital circuits, and a fifth PLL provides the clock for the serial data interface.

A multichip synchronization mechanism synchronizes the phase of all LOs and baseband clocks between multiple ADRV9026 chips. All voltage controlled oscillators (VCOs) and loop filter components are integrated and adjustable through the digital control interface.

The serial data interface consists of four serializer lanes and four deserializer lanes. The interface supports both the JESD204B and JESD204C standards, operating at data rates up to 24.33 Gbps. The interface also supports interleaved mode for lower bandwidths, thus reducing the number of high speed data interface lanes to one. Both fixed and floating-point data formats are supported. The floating-point format allows internal automatic gain control (AGC) to be invisible to the demodulator device.

The ADRV9026 is powered directly from 1.0 V, 1.3 V, and 1.8 V regulators and is controlled via a standard serial peripheral interface (SPI) serial port. Comprehensive power-down modes are included to minimize power consumption in normal use. The ADRV9026 is packaged in a 14 mm × 14 mm, 289-ball chip scale ball grid array (CSP\_BGA).

**TABLE OF CONTENTS**

Features.....	1	2600 MHz Band.....	67
Applications .....	1	3800 MHz Band.....	82
General Description.....	1	4800 MHz Band.....	97
Revision History .....	2	5700 MHz Band.....	112
Functional Block Diagram .....	3	Theory of Operation .....	127
Specifications .....	4	General.....	127
Transmitters and Receivers.....	4	Transmitter .....	127
Synthesizers, Auxiliary Converters, and Clock References..	11	Receiver .....	127
Digital Specifications .....	14	Observation Receiver.....	127
Power Supply Specifications.....	15	Clock Input .....	127
Current Consumption .....	16	Synthesizers.....	128
Digital Interface and Timing Specifications.....	17	SPI Interface.....	128
Absolute Maximum Ratings .....	18	GPIO_x Pins .....	128
Junction Temperature .....	18	Auxiliary Converters .....	128
Reflow Profile.....	18	JTAG Boundary Scan .....	129
Thermal Resistance .....	18	Applications Information .....	130
ESD Caution.....	18	Power Supply Sequence.....	130
Pin Configuration and Function Descriptions .....	19	Data Interface .....	130
Typical Performance Characteristics.....	24	Outline Dimensions.....	131
75 MHz Band .....	24	Ordering Guide .....	131
800 MHz Band .....	37		
1800 MHz Band.....	52		

**REVISION HISTORY**

**1/2021—Rev. B to Rev. C**

Changes to Features Section and General Description Section .....	1
Changes to Table 1 .....	4
Changes to Table 8 .....	17
Changes to Figure 2.....	19
Changes to Typical Performance Characteristics Section.....	24
Added 75 MHz Band Section and Figure 3 to Figure 75; Renumbered Sequentially .....	24
Changes to Figure 84 .....	38
Changes to Figure 155 .....	50
Changes to Figure 171 .....	53
Changes to Figure 313 .....	77
Changes to Figure 481 .....	106
Changes to Figure 519 .....	113
Changes to Data Interface Section, Table 17, Table 18, and Table 19.....	130
Changes to Ordering Guide.....	131

**8/2020—Rev. A to Rev. B**

Changes to Figure 1.....	3
Changes to Table 1 .....	6
Changes to TDD Operation—Four Receiver Channels Enabled Section .....	16

**3/2020—Rev. 0 to Rev. A**

Changes to Features Section and General Description Section .....	1
Change to Observation Receivers Parameter, Table 1.....	8
Changed Synthesizers, Auxiliary ADCs, Reference Section to Synthesizers, Auxiliary Converters, and Clock References Section.....	11
Change to Spot Phase Noise: Wideband Parameter, Table 2 .....	12
Change to System Reference Inputs Parameter, Table 2.....	13
Changes to Table 3 .....	14
Changes to Current Consumption Section, Table 5, Table 6, and Table 7 .....	16
Changes to Table 8.....	17
Change to Table 13 .....	20
Changes to General Section and Observation Receiver Section.....	114
Added Table 14; Renumbered Sequentially .....	114
Added JTAG Boundary Scan Section, Table 15, and Table 16.....	116
Changes to Data Interface Section, Table 17, Table 18, and Table 19.....	117

**11/2019—Revision 0: Initial Version**

# FUNCTIONAL BLOCK DIAGRAM

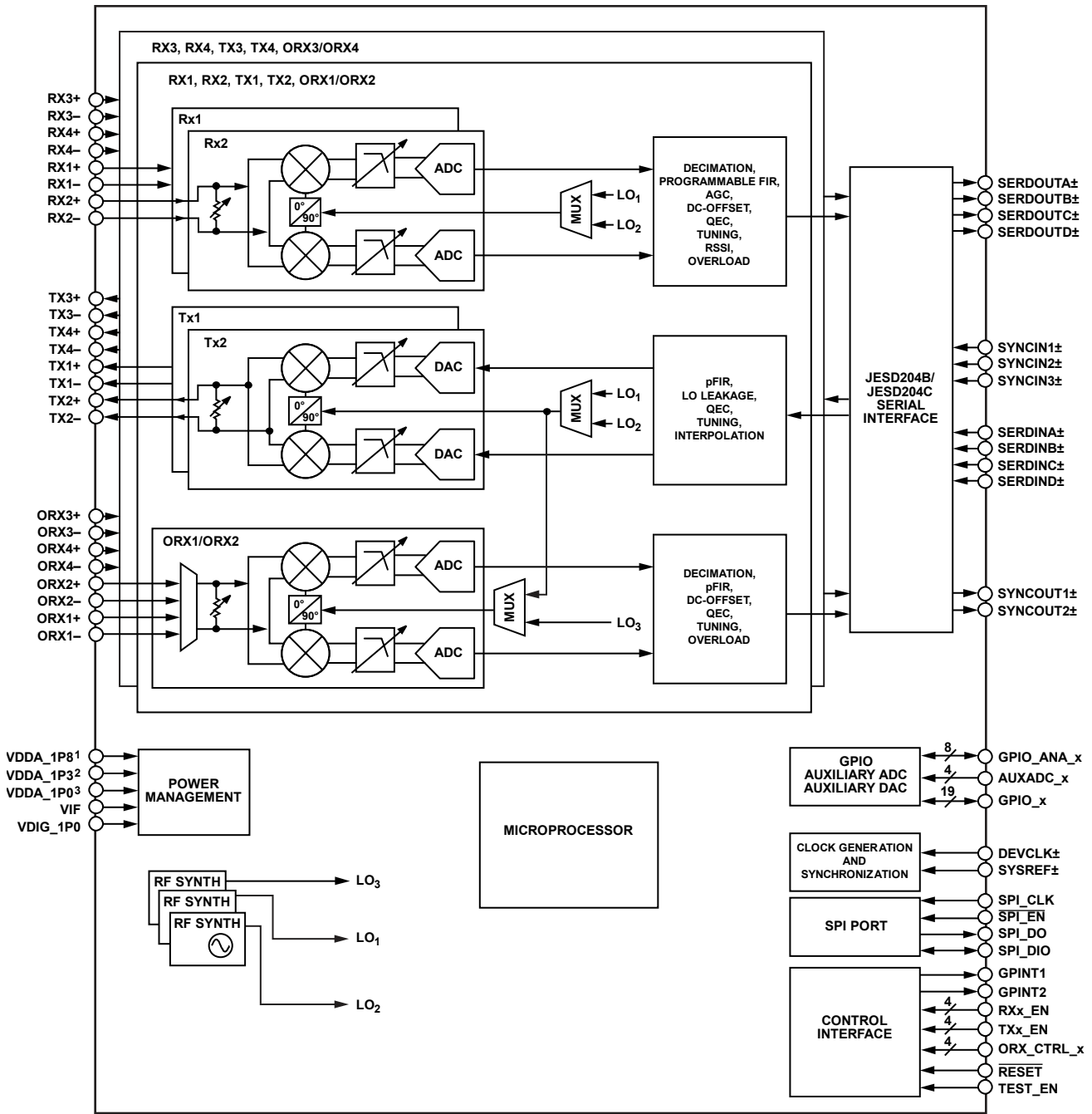

<sup>1</sup>VDDA\_1P8 REPRESENTS VCONV1\_1P8, VCONV2\_1P8, VANA1\_1P8, VANA2\_1P8, VANA3\_1P8, VANA4\_1P8, AND VJVCO\_1P8.  
<sup>2</sup>VDDA\_1P3 REPRESENTS VANA1\_1P3, VANA2\_1P3, VCONV1\_1P3, VCONV2\_1P3, VRFVCO1\_1P3, VRFVCO2\_1P3, VAUXVCO\_1P3, VCLKVCO\_1P3, VRFVSYN1\_1P3, VRFVSYN2\_1P3, VCLKSYN\_1P3, VAUXSYN\_1P3, VRXLO\_1P3, AND VTXLO\_1P3.  
<sup>3</sup>VDDA\_1P0 REPRESENTS VJSYN\_1P0, VDES\_1P0, VTT\_DES, AND VUSER\_1P0.

Figure 1.

22382-001

## SPECIFICATIONS

Electrical characteristics at ambient temperature range. Power supplies are as follows: VDDA\_1P8 = 1.8 V, VIF = 1.8 V, VDDA\_1P3 = 1.3 V, VDDA\_1P0 = 1.0 V, and VDIG\_1P0 = 1.0 V. VDDA\_1P8 represents VCONV1\_1P8, VCONV2\_1P8, VANA1\_1P8, VANA2\_1P8, VANA3\_1P8, VANA4\_1P8, and VJVCO\_1P8. VDDA\_1P3 represents VANA1\_1P3, VANA2\_1P3, VCONV1\_1P3, VCONV2\_1P3, VRFVCO1\_1P3, VRFVCO2\_1P3, VAUXVCO\_1P3, VCLKVCO\_1P3, VRFSYN1\_1P3, VRFSYN2\_1P3, VCLKSYN\_1P3, VAUXSYN\_1P3, VRXLO\_1P3, and VTXLO\_1P3. VDDA\_1P0 represents VJSYN\_1P0, VDES\_1P0, VTT\_DES, and VSER\_1P0. All RF specifications are based on measurements that include printed circuit board (PCB) and matching circuit losses, unless otherwise noted.

Device configuration profile: Receiver = 200 MHz bandwidth, I/Q rate = 245.76 MHz, transmitter = 200 MHz large signal bandwidth plus 450 MHz synthesis bandwidth, I/Q rate = 491.52 MHz, observation receiver (OR<sub>x</sub>) = 450 MHz bandwidth, I/Q rate = 491.52 MHz, device clock = 245.76 MHz, unless otherwise noted. Characterization at 75 MHz followed this profile: Receiver = 62.5 MHz bandwidth, I/Q rate = 76.8 MHz, transmitter = 62.5 MHz large signal bandwidth plus 141 MHz synthesis bandwidth, I/Q rate = 153.6 MHz, observation receiver = 141 MHz bandwidth, I/Q rate = 153.6 MHz, device clock = 153.6 MHz.

Note: if signals are placed outside of the primary bandwidth, degradation in linearity, image rejection, and flatness may be observed.

## TRANSMITTERS AND RECEIVERS

Table 1.

Parameter	Symbol	Min	Typ	Max	Unit	Test Conditions/Comments
<b>TRANSMITTERS</b>						
Center Frequency	Tx	75		6000	MHz	
Tx Synthesis Bandwidth				450	MHz	
Tx Large Signal Bandwidth				200	MHz	Zero intermediate frequency (IF) mode
Peak-to-Peak Gain Deviation			1.0		dB	450 MHz bandwidth, includes compensation by programmable finite impulse response (FIR) filter
			0.1		dB	Any 20 MHz bandwidth span, includes compensation by programmable FIR filter (pFIR)
Deviation from Linear Phase			1		Degrees	450 MHz bandwidth
Maximum Output Power						0 dBFS, 1 MHz signal input, 50 Ω load, 0 dB transmitter attenuation
75 MHz			7.0		dBm	
800 MHz			6.7		dBm	
1800 MHz			6.6		dBm	
2600 MHz			6.3		dBm	
3800 MHz			6.4		dBm	
4800 MHz			6.1		dBm	
5700 MHz			6.4		dBm	
Power Control Range			32		dB	
Power Control Resolution			0.05		dB	
Attenuation Accuracy						
Integral Nonlinearity (Gain)	INL		0.1		dB	Valid over full power control range for any 4 dB step
Differential Nonlinearity (Gain)	DNL		±0.04		dB	Monotonic
Output Power Temperature Slope			-4.5		mdB/°C	Valid over full power control range
LO Delay Temperature Slope			1.05		ps/°C	Valid over full power control range
Adjacent Channel Leakage Power Ratio (ACLR) Long Term Evolution (LTE)						20 MHz LTE at -12 dBFS
75 MHz			-64		dB	
800 MHz			-68		dB	
1800 MHz			-67		dB	
2600 MHz			-66		dB	
3800 MHz			-65		dB	
4800 MHz			-65		dB	
5700 MHz			-65		dB	

Parameter	Symbol	Min	Typ	Max	Unit	Test Conditions/Comments
In Band Noise Floor			-154.5		dBFS/Hz	0 dB attenuation; in band noise falls 1 dB for each decibel of attenuation for attenuation settings between 0 dB and 20 dB
Interpolation Images			-76		dBc	
Tx to Tx Isolation: All Tx Output Effects on All Other Tx Outputs						
800 MHz			78		dB	
1800MHz			77		dB	
2600 MHz			77		dB	
3800 MHz			71		dB	
4800 MHz			70		dB	
5700 MHz			65		dB	
Image Rejection						
Within 200 MHz Large Signal Bandwidth						QEC active up to 20 dB of attenuation, continuous wave tone swept across the large signal bandwidth
75 MHz			80		dB	
800 MHz			76		dB	
1800 MHz			75		dB	
2600 MHz			73		dB	
3800 MHz			65		dB	
4800 MHz			64		dB	
5700 MHz			61		dB	
Beyond Large Signal Bandwidth						Assumes that distortion power density is 25 dB below desired power density
800 MHz			40		dB	
1800 MHz			38		dB	
2600 MHz			34		dB	
3800 MHz			37		dB	
4800 MHz			37		dB	
5700 MHz			37		dB	
Output Impedance	Z <sub>OUT</sub>		50		Ω	Differential—nominal
Maximum Output Load Voltage Standing Wave Ratio	VSWR			3		Maximum value to ensure adequate calibration
Output Return Loss			10		dB	
Output Third-Order Intercept Point	OIP3					0 dB transmitter attenuation
75 MHz			30		dBm	
800 MHz			29		dBm	
1800 MHz			29		dBm	
2600 MHz			28		dBm	
3800 MHz			26.5		dBm	
4800 MHz			29		dBm	
5700 MHz			27		dBm	
Carrier Leakage						With LO leakage correction active, 0 dB transmitter attenuation, scales decibel for decibel with attenuation
Carrier Offset from LO						
75 MHz LO			-84		dBFS/MHz	
800 MHz LO			-84		dBFS/MHz	
1800 MHz LO			-84		dBFS/MHz	
2600 MHz LO			-83		dBFS/MHz	
3800 MHz LO			-84		dBFS/MHz	
4800 MHz LO			-84		dBFS/MHz	
5700 MHz LO			-83		dBFS/MHz	

Parameter	Symbol	Min	Typ	Max	Unit	Test Conditions/Comments
Carrier on the LO			-71		dBFS/MHz	Measured using an LTE 20 MHz signal
Error Vector Magnitude	EVM					PLL optimized for narrow-band noise, measured using LTE 20 MHz signal
75 MHz LO			0.25		%	50 kHz PLL bandwidth
800 MHz LO			0.38		%	50 kHz PLL bandwidth
1800 MHz LO			0.60		%	50 kHz PLL bandwidth
2600 MHz LO			0.44		%	500 kHz PLL bandwidth
3800 MHz LO			0.53		%	200 kHz PLL bandwidth
4800 MHz LO			0.63		%	400 kHz PLL bandwidth
5700 MHz LO			0.84		%	500 kHz PLL bandwidth
Transmitter Time Division Duplex	TDD					
Time from $\overline{\text{SPI\_EN}}$ Going High to Change in Tx Attenuation	$t_{\text{SCH}}$		12		ns	
Time Between Consecutive Microattenuation Steps	$t_{\text{ACH}}$		20		ns	A large change in attenuation can be segmented into a series of smaller attenuation changes
Attenuation Overshoot During Transition			0.1		dB	
Change in Attenuation per Microstep			0.1		dB	
<b>RECEIVERS</b>	Rx					
Center Frequency		75		6000	MHz	
Gain Range			30		dB	
Attenuation Accuracy						
Analog Gain Step			0.5		dB	Attenuator steps from 0 dB to 6 dB
Residual Gain Step Error			1		dB	Attenuator steps from 6 dB to 30 dB
Gain Temperature Slope			0.1		dB	
Internal LO Delay Temperature Slope			-6.4		mdB/°C	
Frequency Response			1.0		ps/°C	
Peak-to-Peak Gain Deviation			1		dB	200 MHz bandwidth, includes compensation by programmable FIR filter
Rx Bandwidth			0.2		dB	Any 20 MHz span, includes compensation by programmable FIR filter
Rx Alias Band Rejection				200	MHz	Zero IF mode
Maximum Useable Input Level	$P_{\text{HIGH}}$	80			dB	Due to digital filters
75 MHz			-11.7		dBm	This continuous wave signal level corresponds to the input power that produces -2 dBFS at the digital output with 0 dB channel attenuation
800 MHz			-12.4		dBm	
1800 MHz			-12.7		dBm	
2600 MHz			-11.9		dBm	
3800 MHz			-11.0		dBm	
4800 MHz			-12.0		dBm	
5700 MHz			-11.1		dBm	
Maximum Source VSWR				3		
Input Impedance	$Z_{\text{IN}}$		100		$\Omega$	Differential
Input Port/Return Loss			10		dB	Unmatched differential port return loss

Parameter	Symbol	Min	Typ	Max	Unit	Test Conditions/Comments
Noise Figure	NF					0 dB receiver attenuation, measured at single-ended input, matching circuit included
75 MHz			12		dB	
800 MHz			11		dB	
1800 MHz			11.5		dB	
2600 MHz			11.9		dB	
3800 MHz			12.8		dB	
4800 MHz			13.3		dB	
5700 MHz			14.5		dB	
Noise Figure Ripple			1.5		dB	At band edge
Second-Order Input Intermodulation Intercept Point	IIP2					0 dB attenuation, complex
75 MHz			70		dBm	
800 MHz			65		dBm	
1800 MHz			65		dBm	
2600 MHz			65		dBm	
3800 MHz			62		dBm	
4800 MHz			62		dBm	
5700 MHz			58		dBm	
Wideband Third-Order Input Intermodulation Intercept Point, Difference Product	IIP3 <sub>WB_DIFF</sub>					Two tones near the band edge, test condition: P <sub>HIGH</sub> – 9 dB/tone
75 MHz			14		dBm	
800 MHz			15		dBm	
1800 MHz			17		dBm	
2600 MHz			17		dBm	
3800 MHz			17		dBm	
4800 MHz			17		dBm	
5700 MHz			18		dBm	
Midband Third-Order Input Intermodulation Intercept Point, Difference Product	IIP3 <sub>MB_DIFF</sub>					Two tones near the middle of the band; test condition: P <sub>HIGH</sub> – 9 dB/tone
75 MHz			20		dBm	
800 MHz			18		dBm	
1800 MHz			22		dBm	
2600 MHz			21		dBm	
3800 MHz			22		dBm	
4800 MHz			22		dBm	
5700 MHz			20		dBm	
Wideband Third-Order Input Intermodulation Intercept Point, Sum Product	IIP3 <sub>WB_SUM</sub>					Two tones approximately bandwidth ÷ 6 offset from the LO; test condition: P <sub>HIGH</sub> – 9 dB/tone
75 MHz			15		dBm	
800 MHz			17		dBm	
1800 MHz			17		dBm	
2600 MHz			20		dBm	
3800 MHz			23		dBm	
4800 MHz			23		dBm	
5700 MHz			20		dBm	
Second-Order Harmonic Distortion Maximum Input	HD2 <sub>MAX</sub>		–72		dBc	P <sub>HIGH</sub> continuous wave signal, harmonic distortion tones falling within 100 MHz of the LO
Recommended Input	HD2		–75		dBc	P <sub>HIGH</sub> – 3 dB continuous wave signal, harmonic distortion tones falling within 100 MHz of the LO

Parameter	Symbol	Min	Typ	Max	Unit	Test Conditions/Comments
Third-Order Harmonic Distortion Maximum Input	HD3 <sub>MAX</sub>		-66		dBc	P <sub>HIGH</sub> continuous wave signal, harmonic distortion tones falling within 100 MHz of the LO
Recommended Input	HD3		-72		dBc	P <sub>HIGH</sub> - 3 dB continuous wave signal, harmonic distortion tones falling within 100 MHz of the LO
Fourth-Order Harmonic Distortion Maximum Input	HD4 <sub>MAX</sub>		-90		dBc	P <sub>HIGH</sub> continuous wave signal, harmonic distortion tones falling within 100 MHz of the LO
Recommended Input	HD4		-90		dBc	P <sub>HIGH</sub> - 3 dB continuous wave signal, harmonic distortion tones falling within 100 MHz of the LO
Fifth-Order Harmonic Distortion Maximum Input	HD5 <sub>MAX</sub>		-87		dBc	P <sub>HIGH</sub> continuous wave signal, harmonic distortion tones falling within 100 MHz of the LO
Recommended Input	HD5		-90		dBc	P <sub>HIGH</sub> - 3 dB continuous wave signal, harmonic distortion tones falling within 100 MHz of the LO
Image Rejection Rx to Rx Signal Isolation			75		dB	QEC active, within 200 MHz receiver bandwidth
75 MHz			80		dB	
800 MHz			75		dB	
1800 MHz			70		dB	
2600 MHz			70		dB	
3800 MHz			65		dB	
4800 MHz			62		dB	
5700 MHz			60		dB	
Rx Band Spurs Referenced to RF Input at Maximum Gain			-95		dBm	No more than one spur at this level per 10 MHz of receiver bandwidth; excludes harmonics of the reference clock
Spurious-Free Dynamic Range	SFDR		81		dBc	P <sub>HIGH</sub> continuous wave signal anywhere inside the band ±20 MHz, excludes harmonic distortion products
Rx Input LO Leakage at Maximum Gain						Leakage decreased decibel for decibel with attenuation for first 12 decibels
75 MHz			-68		dBm	
800 MHz			-68		dBm	
1800 MHz			-68		dBm	
2600 MHz			-65		dBm	
3800 MHz			-65		dBm	
4800 MHz			-58		dBm	
5700 MHz			-54		dBm	
Tx to Rx Signal Isolation: All Tx Output Effects on all Rx Inputs						
75 MHz			80		dB	
800 MHz			80		dB	
1800 MHz			75		dB	
2600 MHz			75		dB	
3800 MHz			65		dB	
4800 MHz			65		dB	
5700 MHz			65		dB	
OBSERVATION RECEIVERS	ORx					
Center Frequency		75		6000	MHz	
Gain Range			30		dB	
Attenuation Accuracy			0.5		dB	Attenuator steps from 0 dB to 6 dB
Analog Gain Step			1		dB	Attenuator steps from 6 dB to 30 dB



Parameter	Symbol	Min	Typ	Max	Unit	Test Conditions/Comments
Peak-to-Peak Gain Deviation			1		dB	450 MHz RF bandwidth, compensation by programmable FIR filter
			0.1		dB	Any 20 MHz bandwidth span, compensation by programmable FIR filter
Deviation from Linear Phase			1		Degrees	450 MHz RF bandwidth
ORx Bandwidth				450	MHz	
ORx Alias Band Rejection		60			dB	Due to digital filters
Maximum Useable Input Level	$P_{HIGH}$					This continuous wave signal level corresponds to the input power that produces $-2$ dBFS at the digital output with 0 dB channel attenuation
75 MHz			-11.4		dBm	
800 MHz			-12.7		dBm	
1800 MHz			-11.5		dBm	
2600 MHz			-10.6		dBm	
3800 MHz			-12.0		dBm	
4800 MHz			-11.3		dBm	
5700 MHz			-9.5		dBm	
Input Impedance	$Z_{IN}$		100		$\Omega$	Differential
Input Source VSWR				3		
Input Port Return Loss			10		dB	Unmatched differential port return loss
Integrated Noise						
450 MHz Bandwidth			-58.5		dBFS	Sample rate at maximum value integrated from 500 kHz to 225 MHz, no input signal
491.52 MHz Bandwidth (Nyquist)			-57.5		dBFS	Sample rate at maximum value integrated from 500 kHz to 245.76 MHz, no input signal
Second-Order Input Intermodulation Intercept Point	IIP2					Maximum observation receiver gain; test condition: $P_{HIGH} - 11$ dB/tone
75 MHz			55		dBm	
800 MHz			55		dBm	
1800 MHz			53		dBm	
2600 MHz			55		dBm	
3800 MHz			48		dBm	
4800 MHz			45		dBm	
5700 MHz			55		dBm	
Third-Order Input Intermodulation Intercept Point	IIP3					Maximum observation receiver gain; test condition: $P_{HIGH} - 11$ dB/tone
Narrow Band	IIP3 <sub>NB</sub>					IM3 product < 130 MHz at baseband; test condition: $P_{HIGH} - 11$ dB/tone, 491.52 MSPS
75 MHz			11		dBm	
800 MHz			13.6		dBm	
1800 MHz			15		dBm	
2600 MHz			16.5		dBm	
3800 MHz			18		dBm	
4800 MHz			18		dBm	
5700 MHz			18		dBm	
Wide Band	IIP3 <sub>WB</sub>					IM3 products > 130 MHz at baseband; test condition: $P_{HIGH} - 11$ dB/tone, 491.52 MSPS
800 MHz			7.8		dBm	
1800 MHz			13		dBm	
2600 MHz			11		dBm	
3800 MHz			13		dBm	
4800 MHz			13		dBm	
5700 MHz			14		dBm	

Parameter	Symbol	Min	Typ	Max	Unit	Test Conditions/Comments
Third-Order Intermodulation Product	IM3					
Narrow Band	IM3 <sub>NB</sub>					IM3 product < 130 MHz at baseband; test condition: two tones, each at P <sub>HIGH</sub> – 11 dB, 491.52 MSPS
800 MHz			-74		dBc	
1800 MHz			-79		dBc	
2600 MHz			-78.6		dBc	
3800 MHz			-80.4		dBc	
4800 MHz			-79.8		dBc	
5700 MHz			-76		dBc	
Wide Band	IM3 <sub>WB</sub>					IM3 product > 130 MHz at baseband; test condition: two tones, each at P <sub>HIGH</sub> – 11 dB, 491.52 MSPS
800 MHz			-62.4		dBc	
1800 MHz			-70		dBc	
2600 MHz			-67.6		dBc	
3800 MHz			-70.4		dBc	
4800 MHz			-69.8		dBc	
5700 MHz			-66		dBc	
Fifth-Order Intermodulation Product	IM5					
Narrow Band	IM5 <sub>NB</sub>					IM5 product < 130 MHz at baseband; test condition: two tones, each at P <sub>HIGH</sub> – 11 dB, 491.52 MSPS
800 MHz			-83		dBc	
1800 MHz			-87		dBc	
2600 MHz			-84		dBc	
3800 MHz			-80		dBc	
4800 MHz			-78		dBc	
5700 MHz			-81		dBc	
Wide Band	IM5 <sub>WB</sub>					IM5 product > 130 MHz at baseband; test condition: two tones, each at P <sub>HIGH</sub> – 11 dB, 491.52 MSPS
800 MHz			-83		dBc	
1800 MHz			-96		dBc	
2600 MHz			-85		dBc	
3800 MHz			-80		dBc	
4800 MHz			-77		dBc	
5700 MHz			-85		dBc	
Seventh-Order Intermodulation Product	IM7					
Narrow Band	IM7 <sub>NB</sub>					IM7 product < 130 MHz at baseband; test condition: two tones, each at P <sub>HIGH</sub> – 11 dB, 491.52 MSPS
800 MHz			-74		dBc	
1800 MHz			-78		dBc	
2600 MHz			-75		dBc	
3800 MHz			-73		dBc	
4800 MHz			-78		dBc	
5700 MHz			-75		dBc	

Parameter	Symbol	Min	Typ	Max	Unit	Test Conditions/Comments
Wide Band	IM7 <sub>WB</sub>					IM7 product > 130 MHz at baseband; test condition: two tones, each at P <sub>HIGH</sub> – 11 dB, 491.52 MSPS
800 MHz			–83		dBc	
1800 MHz			–82		dBc	
2600 MHz			–83		dBc	
3800 MHz			–83		dBc	
4800 MHz			–85		dBc	
5700 MHz			–81		dBc	
Spurious-Free Dynamic Range	SFDR		64		dB	Nonintermodulation related spurs; does not include harmonic distortion; input set at P <sub>HIGH</sub> – 8 dB
Second-Order Harmonic Distortion	HD2					Input set at P <sub>HIGH</sub> – 8 dB
In Band			–80		dBc	In-band harmonic distortion falls within ±100 MHz
Out of Band			–73		dBc	Out of band harmonic distortion falls within ±225 MHz
Third-Order Harmonic Distortion	HD3					Input set at P <sub>HIGH</sub> – 8 dB
In Band			–70		dBc	Harmonic distortion falls within ±100 MHz
Out of Band			–65		dBc	Harmonic distortion falls within ±225 MHz
Image Rejection			75		dB	After online tone calibration, QEC active
Tx to ORx Signal Isolation: All Tx Output Effects on all ORx Inputs			75		dB	

## SYNTHESIZERS, AUXILIARY CONVERTERS, AND CLOCK REFERENCES

Table 2.

Parameter	Symbol	Min	Typ	Max	Unit	Test Conditions/Comments
LO1 and LO2 SYNTHESIZER	LO1, LO2					
Frequency Step			7.3		Hz	1.6 GHz to 3.2 GHz, 245.76 MHz phase frequency detector (PFD) frequency
Spectral Purity			–80		dBc	
Integrated Phase Noise						Integrated from 1 kHz to 100 MHz
Narrow Bandwidth						PLL bandwidth optimized to minimize phase noise at offsets > 200 kHz
Optimized						
800 MHz			0.12		°rms	
1800 MHz			0.27		°rms	
2600 MHz			0.66		°rms	
3800 MHz			0.53		°rms	
4800 MHz			0.91		°rms	
5700 MHz			1.57		°rms	
Wide Bandwidth						PLL bandwidth optimized for integrated phase noise and phase noise at offsets > 1 MHz and phase noise at offsets > 1 MHz
Optimized						
800 MHz			0.07		°rms	
1800 MHz			0.11		°rms	
2600 MHz			0.17		°rms	
3800 MHz			0.26		°rms	
4800 MHz			0.30		°rms	
5700 MHz			0.42		°rms	
Spot Phase Noise: Narrow Band						PLL bandwidth optimized to minimize phase noise at offsets > 200 kHz
800 MHz LO1 and LO2						
100 kHz Offset			–115		dBc/Hz	
1 MHz Offset			–141		dBc/Hz	
10 MHz Offset			–162		dBc/Hz	

Parameter	Symbol	Min	Typ	Max	Unit	Test Conditions/Comments
1800 MHz LO1 and LO2						
100 kHz Offset			-107		dBc/Hz	
200 kHz Offset			-115		dBc/Hz	
400 kHz Offset			-123		dBc/Hz	
600 kHz Offset			-128		dBc/Hz	
800 kHz Offset			-131		dBc/Hz	
1.2 MHz Offset			-136		dBc/Hz	
1.8 MHz Offset			-140		dBc/Hz	
6 MHz Offset			-151		dBc/Hz	
10 MHz Offset			-156		dBc/Hz	
2600 MHz LO1 and LO2						
100 kHz Offset			-97		dBc/Hz	
1 MHz Offset			-124		dBc/Hz	
10 MHz Offset			-150		dBc/Hz	
3800 MHz LO1 and LO2						
100 kHz Offset			-100		dBc/Hz	
1 MHz Offset			-126		dBc/Hz	
10 MHz Offset			-149		dBc/Hz	
4800 MHz LO1 and LO2						
100 kHz Offset			-94		dBc/Hz	
1 MHz Offset			-120		dBc/Hz	
10 MHz Offset			-145		dBc/Hz	
5700 MHz LO1 and LO2						
100 kHz Offset			-89		dBc/Hz	
1 MHz Offset			-115		dBc/Hz	
10 MHz Offset			-141		dBc/Hz	
Spot Phase Noise: Wideband						PLL bandwidth optimized for integrated phase noise and phase noise at offsets > 1 MHz
800 MHz LO1 and LO2						
100 kHz Offset			-114		dBc/Hz	
1 MHz Offset			-141		dBc/Hz	
10 MHz Offset			-162		dBc/Hz	
1800 MHz LO1 and LO2						
100 kHz Offset			-112		dBc/Hz	
1 MHz Offset			-133		dBc/Hz	
10 MHz Offset			-156		dBc/Hz	
2600 MHz LO1 and LO2						
100 kHz Offset			-112		dBc/Hz	
1 MHz Offset			-120		dBc/Hz	
10 MHz Offset			-149		dBc/Hz	
3800 MHz LO						
100 kHz Offset			-104		dBc/Hz	
1 MHz Offset			-125		dBc/Hz	
10 MHz Offset			-149		dBc/Hz	
4800 MHz LO1 and LO2						
100 kHz Offset			-106		dBc/Hz	
1 MHz Offset			-117		dBc/Hz	
10 MHz Offset			-144		dBc/Hz	
5700 MHz LO1 and LO2						
100 kHz Offset			-104		dBc/Hz	
1 MHz Offset			-112		dBc/Hz	
10 MHz Offset			-140		dBc/Hz	

Parameter	Symbol	Min	Typ	Max	Unit	Test Conditions/Comments
AUXILIARY SYNTHESIZER	LO3					
Frequency Step			1.8		Hz	1.625 GHz to 3.25 GHz, 61.44 MHz PFD frequency
Spectral Purity			-65		dBc	$ f_{RFLO} - f_{AUXLO}  > 15$ MHz
Integrated Phase Noise						Integrated from 1 kHz to 100 MHz, PLL bandwidth optimized for integrated phase noise
800 MHz LO3			0.18		°rms	
1800 MHz LO3			0.22		°rms	
2600 MHz LO3			0.46		°rms	
3800 MHz LO3			0.43		°rms	
4800 MHz LO3			0.70		°rms	
5700 MHz LO3			1.12		°rms	
Spot Phase Noise						
800 MHz LO3						
100 kHz Offset			-112		dBc/Hz	
1 MHz Offset			-121		dBc/Hz	
10 MHz Offset			-141		dBc/Hz	
1800 MHz LO3						
100 kHz Offset			-110		dBc/Hz	
1 MHz Offset			-120		dBc/Hz	
10 MHz Offset			-134		dBc/Hz	
2600 MHz LO3						
100 kHz Offset			-103		dBc/Hz	
1 MHz Offset			-114		dBc/Hz	
10 MHz Offset			-132		dBc/Hz	
3800 MHz LO3						
100 kHz Offset			-104		dBc/Hz	
1 MHz Offset			-114		dBc/Hz	
10 MHz Offset			-128		dBc/Hz	
4800 MHz LO3						
100 kHz Offset			-100		dBc/Hz	
1 MHz Offset			-110		dBc/Hz	
10 MHz Offset			-127		dBc/Hz	
5700 MHz LO3						
100 kHz Offset			-95		dBc/Hz	
1 MHz Offset			-106		dBc/Hz	
10 MHz Offset			-126		dBc/Hz	
LO PHASE SYNCHRONIZATION						
Initial Phase Sync Accuracy			0.9		ps	
CLOCK SYNTHESIZER						
4915.2 MHz Sample Clock						
Integrated Phase Noise			0.69		°rms	1 kHz to 10 MHz, PLL bandwidth optimized for integrated phase noise
Spot Phase Noise						PLL bandwidth optimized for integrated phase noise
100 kHz Offset			-96		dBc/Hz	
1 MHz Offset			-113		dBc/Hz	
10 MHz Offset			-140		dBc/Hz	
3932.16 MHz Sample Clock						
Integrated Phase Noise			0.89		°rms	1 kHz to 10 MHz, PLL bandwidth optimized to minimize phase noise at offsets >200 kHz

Parameter	Symbol	Min	Typ	Max	Unit	Test Conditions/Comments
Spot Phase Noise						PLL bandwidth optimized to minimize phase noise at offsets >200 kHz
100 kHz Offset			-91		dBc/Hz	
1 MHz Offset			-120		dBc/Hz	
10 MHz Offset			-143		dBc/Hz	
REFERENCE CLOCK (DEV_CLK± INPUT SIGNAL)	DEV_CLK+, DEV_CLK-					
Frequency Range		15		1000	MHz	
Signal Level (Differential)		0.2		1.0	V p-p	AC-coupled, common-mode voltage internally supplied; for optimal spurious performance and to meet the specified PLL performance parameters, use a 1 V p-p input clock
SYSTEM REFERENCE INPUTS	SYSREF+, SYSREF-					
Logic Compliance			LVDS/LVPECL			
Differential Input Voltage		400	800	1800	mV p-p	External 100 Ω differential termination
Input Common-Mode Voltage			0.675	2.0	V	
Input Resistance (Differential)			18		kΩ	
Input Capacitance (Differential)			1		pF	
AUXILIARY CONVERTERS						
ADC						
Resolution			10		Bits	
Input Voltage						
Minimum			0.05		V	
Maximum			0.95		V	
AUXDAC_0						
Resolution			12		Bits	
Output Voltage						
Minimum			0.2		V	
Maximum			VDDA_1P8 - 0.25		V	
AUXDAC_1 To AUXDAC_7						
Resolution			12		Bits	
Output Voltage						
Minimum			0.1		V	
Maximum			VDDA_1P8 - 0.1		V	
Drive Capability			10		mA	

DIGITAL SPECIFICATIONS

Table 3.

Parameter	Min	Typ	Max	Unit	Test Conditions/Comments
DIGITAL SPECIFICATIONS— SINGLE-ENDED SIGNALS					Applies to the following pins: GPIO_x, GPINTx, TXx_EN, RXx_EN, ORX_CTRL_x, TEST_EN, RESET, SPI_EN, SPI_CLK, SPI_DO, and SPI_DIO
Logic Inputs					
Input Voltage					
High Level	VIF × 0.65		VIF + 0.18	V	
Low Level	-0.30		VIF × 0.35	V	

Parameter	Min	Typ	Max	Unit	Test Conditions/Comments
Input Current					
High Level	-10		+10	μA	
Low Level	-10		+10	μA	
Logic Outputs					
Output Voltage					
High Level	V <sub>IF</sub> - 0.45			V	
Low Level			0.45	V	
Drive Capability		10		mA	
DIGITAL SPECIFICATIONS—DIFFERENTIAL SIGNALS					
Logic Inputs					Applies to the SYNCINx± pins and the SYNCOUTx± pins
Input Voltage Range	825		1675	mV	Each differential input in the pair
Input Differential Voltage Threshold	-100		+100	mV	
Receiver Differential Input Impedance		100		Ω	Internal termination enabled
Logic Outputs					
Output Voltage					
High			1375	mV	
Low	1025			mV	
Differential Offset		225		mV	
		1200		mV	
DIGITAL SPECIFICATIONS—VDDA_1P8 REFERENCED SIGNALS					
Logic Inputs					Applies to the GPIO_ANA_x pins
Input Voltage					
High Level	VDDA_1P8 × 0.65		VDDA_1P8 + 0.18	V	
Low Level	-0.30		VDDA_1P8 × 0.35	V	
Input Current					
High Level	-10		+10	μA	
Low Level	-10		+10	μA	
Logic Outputs					
Output Voltage					
High Level	VDDA_1P8 - 0.45			V	
Low Level			0.45	V	
Drive Capability		10		mA	

## POWER SUPPLY SPECIFICATIONS

Table 4. Power Supply Voltages

Parameter	Min	Typ	Max	Unit
SUPPLY CHARACTERISTICS				
VDDA_1P0 Supply	0.95	1.0	1.05	V
VDIG Supply	0.95	1.0	1.05	V
VDDA_1P3 Supply	1.235	1.3	1.365	V
VDDA_1P8 Supply	1.71	1.8	1.89	V
V <sub>IF</sub> Supply	1.71	1.8	1.89	V

**CURRENT CONSUMPTION**

In Table 5, Table 6, and Table 7, the first row contains the data for the UC13-NLS profile and subsequent rows provide UC13-NLS profile details. Note that all current measurements reported in Table 5, Table 6, and Table 7 are obtained at room temperature without a heat sink.

**TDD Operation—Four Receiver Channels Enabled**

Maximum gain and typical values.

**Table 5.**

Profile Conditions	Supply (A)			Total Average Power (W)	75% Tx, 25% Rx Average Power (W)
	1.0 V	1.3 V	1.8 V		
USE CASE UC13-NLS (16 BITS) 245.76 MSPS Tx/ORx Data Rate 122.88 MSPS Rx Data Rate 245.76 MHz Device Clock	1.181	2.003	0.217	4.19	5.01

**TDD Operation—Four Transmitter and One Observation Receiver Channels Enabled**

Maximum gain, 0 dB attenuation, typical values.

**Table 6.**

Profile Conditions	Supply (A)			Total Average Power (W)	75% Tx, 25% Rx Average Power (W)
	1.0 V	1.3 V	1.8 V		
USE CASE UC13-NLS (16 BITS) 245.76 MSPS Tx/ORx Data Rate 122.88 MSPS Rx Data Rate 245.76 MHz Device Clock	1.419	2.084	0.633	5.28	5.01

**FDD Operation—LO1 and LO2, Four Receiver, Four Transmitter, and One Observation Receiver Channels Enabled**

Maximum gain, 0 dB attenuation, typical values.

**Table 7.**

Profile Conditions	Supply (A)			Total Average Power (W)
	1.0 V	1.3 V	1.8 V	
USE CASE UC13-NLS (16 BITS) 245.76 MSPS Tx/ORx Data Rate 122.88 MSPS Rx Data Rate 245.76 MHz Device Clock	1.664	2.929	0.762	6.86



## DIGITAL INTERFACE AND TIMING SPECIFICATIONS

Table 8.

Parameter	Symbol	Min	Typ	Max	Unit	Test Conditions/Comments
SERIAL PERIPHERAL INTERFACE (SPI) TIMING						
SPI_CLK Period	$t_{CP}$	40			ns	
SPI_CLK Pulse Width	$t_{MP}$	10			ns	
SPI_EN Setup to First SPI_CLK Rising Edge	$t_{SC}$	4			ns	
Last SPI_CLK Falling Edge to SPI_EN Hold	$t_{HC}$	0			ns	
SPI_DIO Data Input Setup to SPI_CLK	$t_S$	4			ns	
SPI_DIO Data Input Hold to SPI_CLK	$t_H$	0			ns	
SPI_CLK Falling Edge to Output Data Delay	$t_{CO}$	10		8	ns	3- or 4-wire mode
Bus Turnaround Time After Baseband Processor Drives Last Address Bit	$t_{HZM}$	$t_H$		$t_{CO}$	ns	
Bus Turnaround Time After ADRV9026 Drives Last Address Bit	$t_{HZS}$	0		$t_{CO}$	ns	
DIGITAL TIMING						
TXx_EN Pulse Width		10			$\mu s$	
RXx_EN Pulse Width		10			$\mu s$	
ORX_CTRL_x Pulse Width		10			$\mu s$	
TXx_EN to Valid Data			2		$\mu s$	
RXx_EN to Valid Data			2		$\mu s$	
ORX_CTRL_x to Valid Data			3		$\mu s$	
JESD204B/JESD204C DATA OUTPUT TIMING						
Unit Interval	UI	41.1		333	ps	
Data Rate per Channel (No Return to Zero (NRZ))		3000		24330.24	Mbps	
Rise Time	$t_R$	17	20		ps	20% to 80% in 100 $\Omega$ load
Fall Time	$t_F$	17	20		ps	20% to 80% in 100 $\Omega$ load
Output Common-Mode Voltage	$V_{CM}$	0		1.8	V	AC-coupled
Differential Output Voltage	$V_{DIFF}$	475		1050	mV p-p	
Short-Circuit Current	$I_{DSHORT}$	-100		+100	mA	
Differential Termination Impedance	$Z_{RDIFF}$	80	100	120	$\Omega$	
SYSREF $\pm$ Input Signal Setup Time to DEV_CLK $\pm$ Input Signal	$t_S$	200			ps	
SYSREF $\pm$ Input Signal Hold Time to DEV_CLK $\pm$ Input Signal	$t_H$	200			ps	
JESD204B/C DATA INPUT TIMING						
Unit Interval	UI	41.1		333	ps	
Data Rate per Channel (NRZ)		3000		24330.24	Mbps	
Input Common-Mode Voltage	$V_{CM}$	0.05		1.65	V	AC-coupled
Termination Voltage = 1.0 V	$V_{TT}$	720		1200	mV	DC-coupled (not recommended)
Differential Input Voltage	$V_{DIFF}$	110		1050	mV	
$V_{TT}$ Source Impedance	$Z_{TT}$		7.5	30	$\Omega$	
Differential Termination Impedance	$Z_{RDIFF}$	80	100	120	$\Omega$	
$V_{TT}$						
AC-Coupled		0.95		1.05	V	
DC-Coupled		0.95		1.05	V	

## ABSOLUTE MAXIMUM RATINGS

Table 9.

Parameter	Rating
VDDA_1P8 to VSSA	-0.3 V to +2.2 V
VDDA_1P3 to VSSA	-0.2 V to +1.5 V
VDDA_1P0, VDIG_1P0 to VSSD, VSSA	-0.2 V to +1.2 V
VIF Referenced Logic Inputs and Outputs to VSSD	-0.3 V to VIF + 0.3 V
JESD204B/JESD204C Logic Outputs to VSSA	-0.3 V to VSER_1P0
JESD204B/JESD204C Logic Inputs to VSSA	-0.3 V to VDES_1P0
Input Current to Any Pin Except Supplies	±10 mA
Maximum Input Power into RF Ports	See Table 11 for limits vs. survival time
Reflow Temperature	260°C
Junction Temperature Range <sup>1</sup>	-40°C to +110°C
Storage Temperature Range	-65°C to +150°C

<sup>1</sup> The maximum junction temperature for continuous operation is 110°C. See the Junction Temperature section for more details.

Stresses at or above those listed under Absolute Maximum Ratings may cause permanent damage to the product. This is a stress rating only; functional operation of the product at these or any other conditions above those indicated in the operational section of this specification is not implied. Operation beyond the maximum operating conditions for extended periods may affect product reliability.

### JUNCTION TEMPERATURE

The maximum junction temperature for continuous operation is 110°C. Although operation up to 125°C is supported, specification compliance is only guaranteed up to 110°C. To avoid a reduction in operating lifetime by operating at temperatures greater than 110°C, the device must operate at a temperature less than 110°C for a period determined by the following equation:

$$t_{UNITS < 110} = (AF_{T > 110} - 1) / (1 - AF_{T < 110})$$

where:

*AF* is the acceleration factor.

*AF<sub>T > 110</sub>* and *AF<sub>T < 110</sub>* are acceleration factors obtained from Table 10.

For example, if the device operates at 125°C for 1 hour, expected device lifetime is maintained if the device operates at 100°C for 4.5 hours to offset the time operating above 110°C.

Table 10. Acceleration Factors for High Temperature Operation

Operating Junction Temperature (°C)	Acceleration Factor
125	3.75
120	2.44
115	1.57
110	1.00
105	0.63
100	0.39
95	0.24
90	0.14

Table 11. Maximum Input Power into RF Ports vs. Lifetime

RF Port Input Power, Continuous Wave Signal (dBm)	Lifetime	
	Gain = -30 dB	Gain = 0 dB
7	>10 years	>10 years
10	>10 years	20,000 hours
20	>10 years	14 hours
23	>10 years	110 minutes
25	>7 years	60 minutes

### REFLOW PROFILE

The ADRV9026 reflow profile is in accordance with the JEDEC JESD20 criteria for lead-free (Pb-free) devices. The maximum reflow temperature is 260°C.

### THERMAL RESISTANCE

Thermal resistance values specified in Table 12 are calculated based on JEDEC specifications and should be used in compliance with JESD51-2. Note that using enhanced heat removal techniques (PCB, heat sink, airflow, and so forth) improves thermal resistance.

Table 12. Thermal Resistance Values

Package Type	θ <sub>JA</sub>	θ <sub>JTOP</sub>	θ <sub>JB</sub>	ψ <sub>JC</sub>	ψ <sub>JB</sub>	Unit
BC-289-6	14.8	0.03	3.4	0.02	3.4	(°C/W)

### ESD CAUTION



**ESD (electrostatic discharge) sensitive device.** Charged devices and circuit boards can discharge without detection. Although this product features patented or proprietary protection circuitry, damage may occur on devices subjected to high energy ESD. Therefore, proper ESD precautions should be taken to avoid performance degradation or loss of functionality.

# PIN CONFIGURATION AND FUNCTION DESCRIPTIONS

ADRV9026  
TOP VIEW  
(Not to Scale)

	1	2	3	4	5	6	7	8	9	10	11	12	13	14	15	16	17
A	VSSA	VSSA	VSSA	TX3+	TX3-	VSSA	VTXLO_1P3	VSSA	VRXLO_1P3	VSSA	VSSA	VSSA	TX2+	TX2-	VSSA	VSSA	VSSA
B	RX3-	VSSA	VSSA	VANA3_1P8	VSSA	VSSA	VSSA	VSSA	VSSA	VSSA	VAUXVCO_1P0	VSSA	VSSA	VANA2_1P8	VSSA	VSSA	RX2+
C	RX3+	VSSA	NIC	GPIO_ANA_7	GPIO_ANA_6	VAUXSYN_1P3	VSSA	DEVCLK+	DEVCLK-	VSSA	VAUXVCO_1P3	GPIO_ANA_1	GPIO_ANA_0	VSSA	RBIAS	VSSA	RX2-
D	VSSA	VSSA	VANA2_1P3	VSSA	VSSA	VSSA	VSSA	SYSREF+	SYSREF-	VSSA	VSSA	VSSA	VSSA	VSSA	VANA1_1P3	VSSA	VSSA
E	AUXADC_3	EXT_LO2-	VSSA	ORX3+	ORX3-	VSSA	TX3_EN	GPIO_11	GPIO_9	GPIO_3	TX2_EN	VSSA	ORX1+	ORX1-	VSSA	EXT_LO1+	AUXADC_1
F	AUXADC_2	EXT_LO2+	VSSA	VSSA	VSSA	VSSA	ORX_CTRL_C	GPIO_12	GPIO_10	GPIO_4	ORX_CTRL_B	VSSA	VSSA	VSSA	VSSA	EXT_LO1-	AUXADC_0
G	VSSA	VSSA	VRFVCO2_1P3	VSSA	VRFVCO2_1P0	VSSA	RX3_EN	GPIO_13	VDIG_1P0	GPIO_5	RX2_EN	VSSA	VRFVCO1_1P0	VSSA	VRFVCO1_1P3	VSSA	VSSA
H	RX4-	VSSA	VCONV2_1P8	VSSA	VSSA	VSSA	GPIO_17	GPIO_14	VSSD	GPIO_6	GPIO_0	VSSA	VSSA	VSSA	VCONV1_1P8	VSSA	RX1+
J	RX4+	VSSA	VCONV2_1P3	VSSA	VRFVCO2_1P3	VSSA	RX4_EN	GPIO_15	VDIG_1P0	GPIO_7	RX1_EN	VSSA	VRFVCO1_1P3	VSSA	VCONV1_1P3	VSSA	RX1-
K	VSSA	VSSA	VCONV2_1P0	VSSA	VSSA	VSSA	GPIO_18	GPIO_16	VSSD	GPIO_8	GPIO_1	VSSA	VSSA	VSSA	VCONV1_1P0	VSSA	VSSA
L	GPIO_ANA_5	GPIO_ANA_4	VSSA	ORX4+	ORX4-	VSSA	ORX_CTRL_D	SPI_DIO	VDIG_1P0	SPI_EN	ORX_CTRL_A	VSSA	ORX2+	ORX2-	VSSA	GPIO_ANA_2	GPIO_ANA_3
M	VSSA	VSSA	VSSA	VSSA	VSSA	VSSA	TX4_EN	SPI_DO	VSSD	SPI_CLK	TX1_EN	VSSA	VSSA	VSSA	VSSA	VSSA	VSSA
N	TX4-	VANA4_1P8	VSSA	VSSA	VCLKVCO_1P3	SYNCIN3+	GPINT2	GPINT1	VIF	RESET	GPIO_2	SYNCIN1+	SYNCIN1-	SYNCOUT2+	SYNCOUT2-	VANA1_1P8	TX1+
P	TX4+	VSSA	VSSA	VSSA	VCLKVCO_1P0	SYNCIN3-	SYNCIN2+	SYNCIN2-	VSSA	TEST_EN	VJVCO_1P8	VDES_1P0	VDES_1P0	VTT_DES	SYNCOUT1+	VSSA	TX1-
R	VSSA	VSSA	VSER_1P0	VSER_1P0	VSSA	VSSA	VCLKSYN_1P3	VSSA	VJSYN_1P0	VSSA	NIC	VSSA	VSSA	VSSA	SYNCOUT1-	VSSA	VSSA
T	VSSA	VSSA	SERDOUTC+	SERDOUTC-	VSSA	VSSA	SERDOUTA+	SERDOUTA-	VSSA	SERDINA-	SERDINA+	VSSA	VSSA	SERDINC-	SERDINC+	VSSA	VSSA
U	SERDOUTD+	SERDOUTD-	VSSA	VSSA	SERDOUTB+	SERDOUTB-	VSSA	VSSA	VSSA	VSSA	VSSA	SERDINB+	SERDINB-	VSSA	VSSA	SERDIND+	SERDIND-

ANALOG GROUND
  DIGITAL POWER
  AUXILIARY ADC INPUTS
  LVDS SERDES CONTROLS
  NOT INTERNALLY CONNECTED

DIGITAL GROUND
  ANALOG INPUTS/OUTPUTS
  DIGITAL INPUTS/OUTPUTS
  SERDES INPUTS/OUTPUTS

ANALOG POWER
  ANALOG GPIO
  SPI BUS
  DIFFERENTIAL SYSREF SIGNAL

NOTES  
1. NIC = NOT INTERNALLY CONNECTED. THESE PINS MUST REMAIN DISCONNECTED.

Figure 2. Pin Configuration

22382-004

Table 13. Pin Function Descriptions

Pin No.	Mnemonic	Type <sup>1</sup>	Description
A1 to A3, A6, A8, A10 to A12, A15 to A17, B2, B3, B5 to B10, B12, B13, B15, B16, C2, C7, C10, C14, C16, D1, D2, D4 to D7, D10 to D14, D16, D17, E3, E6, E12, E15, F3 to F6, F12 to F15, G1, G2, G4, G6, G12, G14, G16, G17, H2, H4 to H6, H12 to H14, H16, J2, J4, J6, J12, J14, J16, K1, K2, K4 to K6, K12 to K14, K16, K17, L3, L6, L12, L15, M1 to M6, M12 to M17, N3, N4, P2 to P4, P9, P16, R1, R2, R5, R6, R8, R10, R12 to R14, R16, R17, T1, T2, T5, T6, T9, T12, T13, T16, T17, U3, U4, U7 to U11, U14, U15	VSSA	I	Analog Ground.
A4, A5	TX3+, TX3–	O	Differential Output for Transmitter Channel 3. If unused, do not connect these pins.
A7	VTXLO_1P3	I	1.3 V Supply Input.
A9	VRXLO_1P3	I	1.3 V Supply Input.
A13, A14	TX2+, TX2–	O	Differential Output for Transmitter Channel 2. When unused, do not connect.
B1, C1	RX3–, RX3+	I	Differential Input for Receiver Channel 3. If unused, connect these pins to VSSA.
B4	VANA3_1P8	I	1.8 V Supply Input.
B11	VAUXVCO_1P0	O	1.0 V Internal Supply Node. Bypass Pin B11 with a 4.7 $\mu$ F capacitor.
B14	VANA2_1P8	I	1.8 V Supply Input.
B17, C17	RX2+, RX2–	I	Differential Input for Receiver Channel 2. If unused, connect these pins to VSSA.
C3, R11	NIC	N/A	Not Internally Connected. These pins must remain disconnected.
C4, C5, L1, L2, L17, L16, C12, C13	GPIO_ANA_7 to GPIO_ANA_0	I/O	General-Purpose Inputs and Outputs. The GPIO_ANA_7 to GPIO_ANA_0 pins are referenced to 1.8 V and can also function as auxiliary DAC outputs. If unused, these pins can be connected to VSSA with a 10 k $\Omega$ resistor or configured as outputs, driven low, and left disconnected.
C6	VAUXSYN_1P3	I	1.3 V Supply Input.
C8, C9	DEVCLK+, DEVCLK–	I	Device Clock Differential Input.
C11	VAUXVCO_1P3	I	1.3 V Supply Input.
C15	RBIAS	I	Bias Resistor Connection. Pin C15 generates an internal current based on an external 1% resistor. Connect a 4.99 k $\Omega$ resistor between Pin C15 and analog ground (VSSA).
D3	VANA2_1P3	I	1.3 V Supply Input.
D8, D9	SYSREF+, SYSREF–	I	LVDS System Reference Clock Inputs for the SERDES Interface. Connect a 100 $\Omega$ termination between these pins.
D15	VANA1_1P3	I	1.3 V Supply Input.
E1	AUXADC_3	I	Auxiliary ADC 3 Input. If Pin E1 is unused, do not connect.
E2, F2	EXT_LO2–, EXT_LO2+	I/O	Differential External LO Input/Output 2. If used for the external LO input, the input frequency must be 2 $\times$ the desired carrier frequency. Do not connect if unused. External LO functionality not supported currently.
E4, E5	ORX3+, ORX3–	I	Differential Input for Observation Receiver Channel 3. Connect to VSSA if unused.
E7	TX3_EN	I	Enable Input for Transmitter Channel 3. Connect to VSSA if unused.

Pin No.	Mnemonic	Type <sup>1</sup>	Description
H11, K11, N11, E10, F10, G10, H10, J10, K10, E9, F9, E8, F8, G8, H8, J8, K8, H7, K7	GPIO_0 to GPIO_18	I/O	General-Purpose Digital Inputs and Outputs. See Figure 2 to match the ball location to the GPIO_x signal name. If unused, these pins can be connected to VSSA with a 10 kΩ resistor or configured as outputs, driven low, and left disconnected.
E11	TX2_EN	I	Enable Input for Transmitter Channel 2. Connect to VSSA if unused.
E13, E14	ORX1+, ORX1–	I	Differential Input for Observation Receiver Channel 1. Connect to VSSA if unused.
E16, F16	EXT_LO1+, EXT_LO1–	I/O	Differential External LO Input/Output 1. If used for the external LO input, the input frequency must be 2× the desired carrier frequency. Do not connect if unused. External LO functionality not currently supported.
E17	AUXADC_1	I	Auxiliary ADC 1 Input. Do not connect if unused.
F1	AUXADC_2	I	Auxiliary ADC 2 Input. Do not connect if unused.
F7, F11, L7, L11	ORX_CTRL_C, ORX_CTRL_B, ORX_CTRL_D, ORX_CTRL_A	I	Determine Active Observation Receiver Path. Connect to VSSA directly or with a pull-down resistor if unused.
F17	AUXADC_0	I	Auxiliary ADC 0 Input. Do not connect if unused.
G3	VRFVCO2_1P3	I	1.3 V Supply Input.
G5	VRFVCO2_1P0	O	1.0 V Internal Supply Node. Bypass this pin with a 4.7 μF capacitor.
G7	RX3_EN	I	Enable Input for Receiver Channel 3. Connect to VSSA if unused.
G9, J9, L9	VDIG_1P0	I	1.0 V Digital Supply Input.
G11	RX2_EN	I	Enable Input for Receiver Channel 2. Connect to VSSA if unused.
G13	VRFVCO1_1P0	O	1.0 V Internal Supply Node. Bypass this pin with a 4.7 μF capacitor.
G15	VRFVCO1_1P3	I	1.3 V Supply Input.
H1, J1	RX4–, RX4+	I	Differential Input for Receiver Channel 4. If unused, connect to VSSA.
H3	VCONV2_1P8	I	1.8 V Supply Input.
H9, K9, M9	VSSD	I	Digital Ground.
H15	VCONV1_1P8	I	1.8 V Supply Input.
H17, J17	RX1+, RX1–	I	Differential Input for Receiver Channel 1. If unused, connect to VSSA.
J3	VCONV2_1P3	I	1.3 V Supply Input.
J5	VRFSYN2_1P3	I	1.3 V Supply Input.
J7	RX4_EN	I	Enable Input for Receiver Channel 4. If unused, connect to VSSA.
J11	RX1_EN	I	Enable Input for Receiver Channel 1. If unused, connect to VSSA.
J13	VRFSYN1_1P3	I	1.3 V Supply Input.
J15	VCONV1_1P3	I	1.3 V Supply Input.
K3	VCONV2_1P0	O	1.0 V Internal Supply Node. Bypass this pin with a 4.7 μF capacitor.
K15	VCONV1_1P0	O	1.0 V Internal Supply Node. Bypass this pin with a 4.7 μF capacitor.
L4, L5	ORX4+, ORX4–	I	Differential Input for Observation Receiver Channel 4. If unused, connect to VSSA.

Pin No.	Mnemonic	Type <sup>1</sup>	Description
L8	SPI_DIO	I/O	Serial Data Input. SPI_DIO is the serial data input in 4-wire mode or input/output in 3-wire mode.
L10	$\overline{\text{SPI\_EN}}$	I	Serial Data Bus Chip Select. Active low.
L13, L14	ORX2+, ORX2-	I	Differential Input for Observation Receiver Channel 2. If unused, connect to VSSA.
M7	TX4_EN	I	Enable Input for Transmitter Channel 4. If unused, connect to VSSA.
M8	SPI_DO	O	Serial Data Output.
M10	SPI_CLK	I	Serial Data Bus Clock Input.
M11	TX1_EN	I	Enable Input for Transmitter Channel 1. If unused, connect to VSSA.
N1, P1	TX4-, TX4+	O	Differential Output for Transmitter Channel 4. If unused, do not connect.
N2	VANA4_1P8	I	1.8 V Supply Input.
N5	VCLKVCO_1P3	I	1.3 V Supply Input.
N6, P6	SYNCIN3+, SYNCIN3-	I	LVDS Sync Signal Input 3. If unused, connect to VSSA.
N7	GPINT2	O	General-Purpose Interrupt Output 2. If unused, do not connect.
N8	GPINT1	O	General-Purpose Interrupt Output 1. If unused, do not connect.
N9	VIF	I	1.8 V Interface Supply Input.
N10	$\overline{\text{RESET}}$	I	Active Low Chip Reset.
N12, N13	SYNCIN1+, SYNCIN1-	I	LVDS Sync Signal Input 1. If unused, connect to VSSA.
N14, N15	SYNCOUT2+, SYNCOUT2-	O	LVDS Sync Signal Output 2. If unused, do not connect.
N16	VANA1_1P8	I	1.8 V Supply Input.
N17, P17	TX1+, TX1-	O	Differential Output for Transmitter Channel 1. Do not connect if unused.
P5	VCLKVCO_1P0	O	1.0 V Internal Supply Node. Bypass this pin with a 4.7 $\mu\text{F}$ capacitor.
P7, P8	SYNCIN2+, SYNCIN2-	I	LVDS Sync Signal Input 2. If unused, connect to VSSA.
P10	TEST_EN	I	Test Input for JTAG Boundary Scan. Pull high to enable boundary scan. If unused, tie to VSSA.
P11	VJVCO_1P8	I	1.8 V Supply Input.
P12, P13	VDES_1P0	I	1.0 V Analog Supply Input.
P14	VTT_DES	I	1.0 V Analog Supply Input.
P15, R15	SYNCOUT1+, SYNCOUT1-	O	LVDS Sync Signal Output 1. If unused, do not connect.
R3, R4	VSER_1P0	I	1.0 V Analog Supply Input.
R7	VCLKSYN_1P3	I	1.3 V Supply Input.
R9	VJSYN_1P0	I	1.0 V Analog Supply Input.
T3, T4	SERDOUTC+, SERDOUTC-	O	SERDES Differential Output C. If unused, do not connect.
T7, T8	SERDOUTA+, SERDOUTA-	O	SERDES Differential Output A. If unused, do not connect.
T10, T11	SERDINA-, SERDINA+	I	SERDES Differential Input A. If unused, do not connect.
T14, T15	SERDINC-, SERDINC+	I	SERDES Differential Input C. If unused, do not connect.
U1, U2	SERDOUTD+, SERDOUTD-	O	SERDES Differential Output D. If unused, do not connect.
U5, U6	SERDOUTB+, SERDOUTB-	O	SERDES Differential Output B. If unused, do not connect.

Pin No.	Mnemonic	Type <sup>1</sup>	Description
U12, U13	SERDINB+, SERDINB-	I	SERDES Differential Input B. If unused, do not connect.
U16, U17	SERDIND+, SERDIND-	I	SERDES Differential Input D. If unused, do not connect.

<sup>1</sup> I is input, O is output, I/O is input/output, and N/A is not applicable.

## TYPICAL PERFORMANCE CHARACTERISTICS

Device configuration profile: receiver = 62.5 MHz bandwidth, I/Q rate = 76.8 MHz, transmitter = 62.5 MHz large signal bandwidth plus 141 MHz synthesis bandwidth, I/Q rate = 153.6 MHz, observation receiver (OR<sub>x</sub>) = 141 MHz bandwidth, I/Q rate = 153.6 MHz, device clock = 153.6 MHz, unless otherwise noted.

### 75 MHz BAND

The temperature settings refer to the die temperature. All LO frequencies set to 75 MHz, unless otherwise noted.

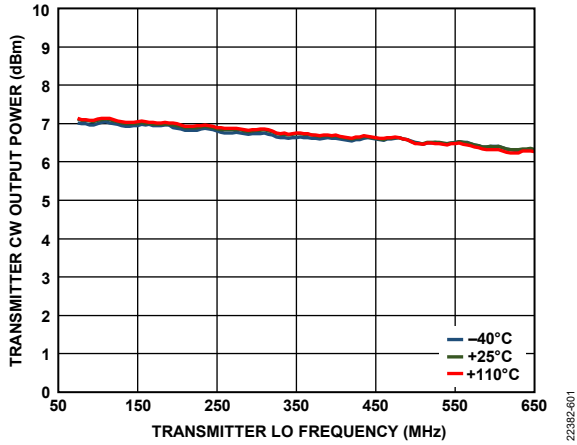

Figure 3. Transmitter Continuous Wave Output Power vs. Transmitter LO Frequency, 10 MHz Offset, 0 dB Attenuation

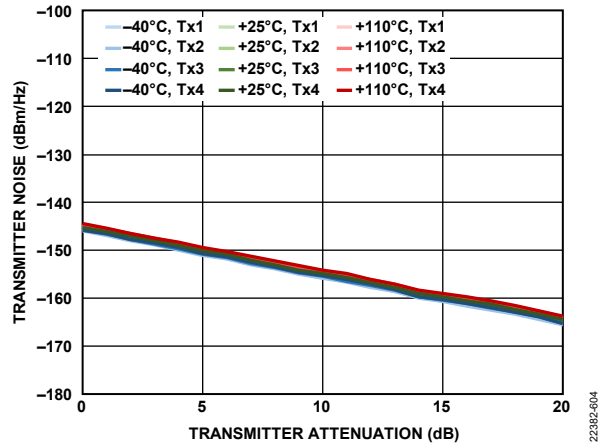

Figure 6. Transmitter Noise vs. Transmitter Attenuation, 10 MHz Offset

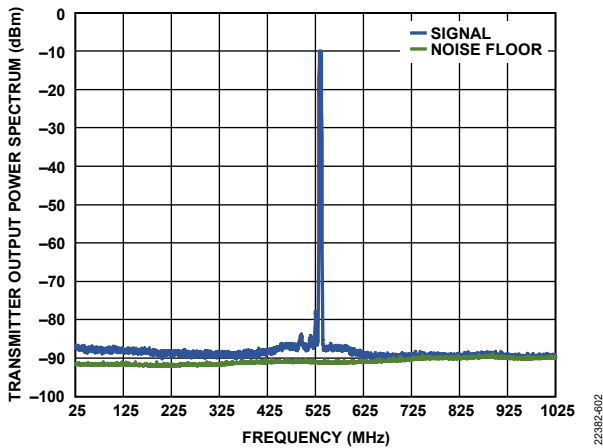

Figure 4. Transmitter Output Power Spectrum, Tx1, 5 MHz LTE, 10 MHz Offset, -10 dBFS RMS, 1 MHz Resolution Bandwidth, T<sub>j</sub> = 25°C

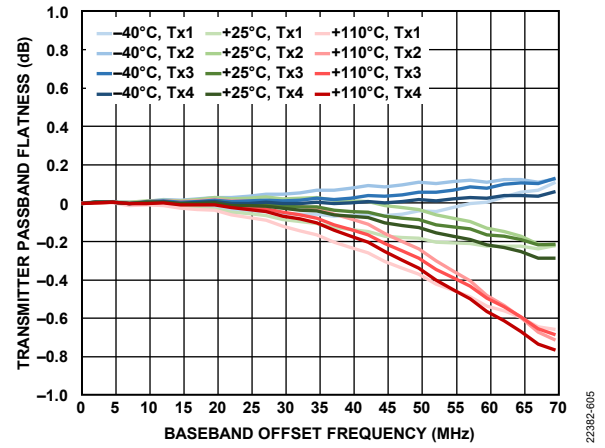

Figure 7. Transmitter Pass Band Flatness vs. Baseband Offset Frequency

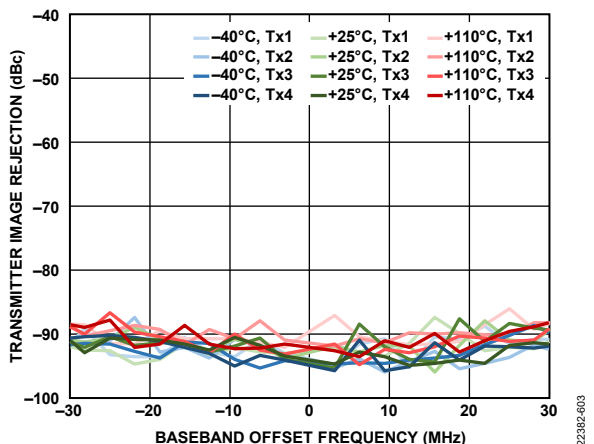

Figure 5. Transmitter Image Rejection Across Large Signal Bandwidth vs. Baseband Offset Frequency

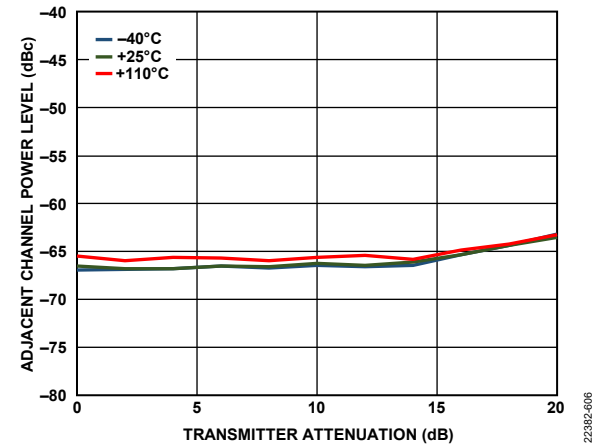

Figure 8. Adjacent Channel Power Level vs. Transmitter Attenuation, 21 MHz Baseband Offset, 5 MHz LTE, Peak to Average Ratio (PAR) = 12 dB



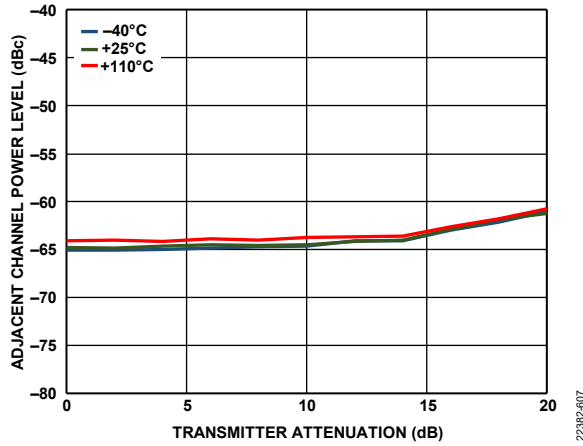

Figure 9. Adjacent Channel Power Level vs. Transmitter Attenuation, 44 MHz Baseband Offset, 5 MHz LTE, PAR = 12 dB

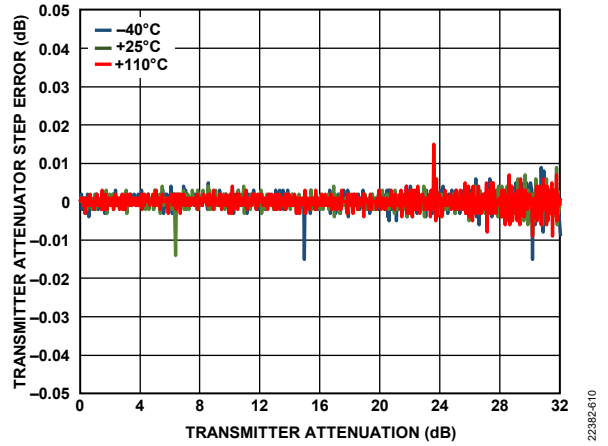

Figure 12. Transmitter Attenuator Step Error vs. Transmitter Attenuation, 10 MHz Offset

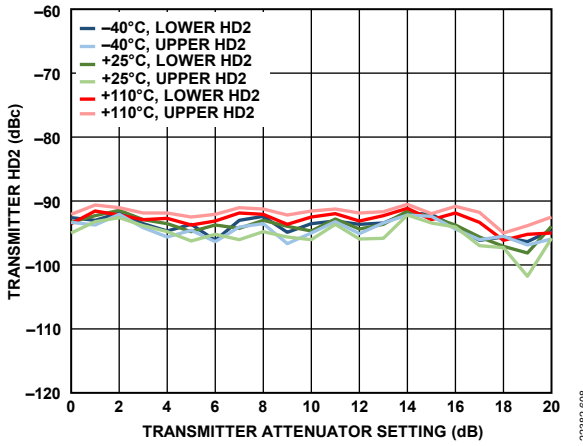

Figure 10. Transmitter Second-Order Harmonic Distortion (HD2) vs. Transmitter Attenuation, 10 MHz Offset

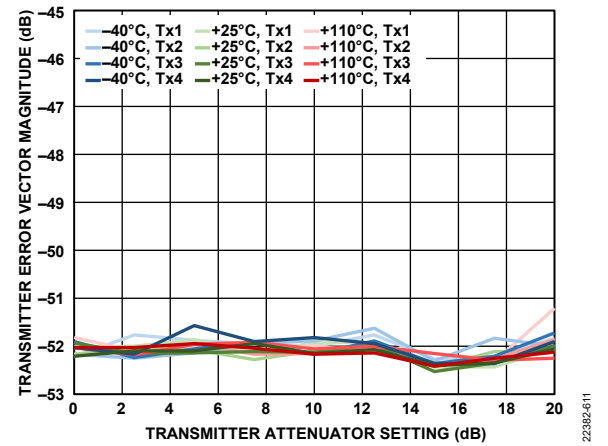

Figure 13. Transmitter Error Vector Magnitude vs. Transmitter Attenuation, 5 MHz LTE Signal Centered at LO Frequency, Sample Rate = 153.6 MSPS, Loop Filter Bandwidth = 50 kHz, Loop Filter Phase Margin = 40°

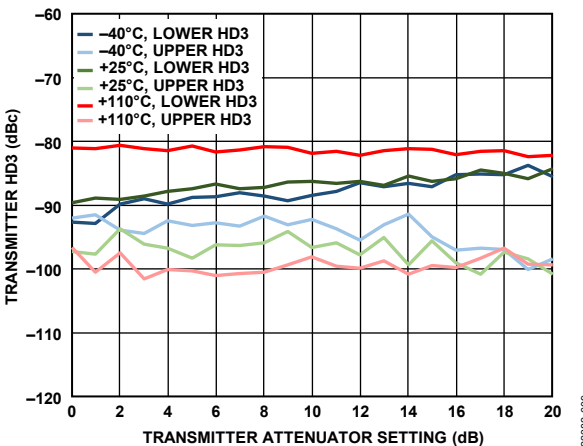

Figure 11. Transmitter Third-Order Harmonic Distortion (HD3) vs. Transmitter Attenuation, 10 MHz Offset

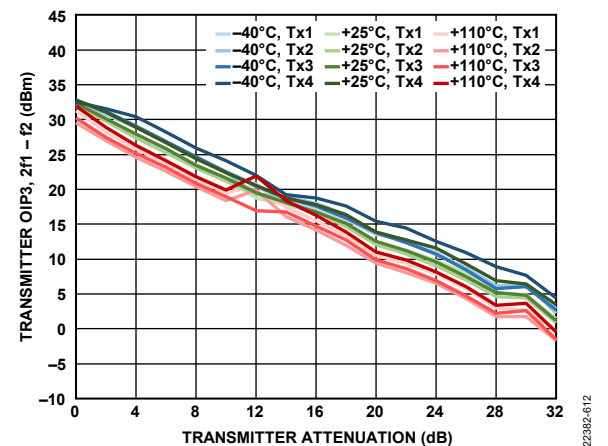

Figure 14. Transmitter OIP3, 2f1 - f2 vs. Transmitter Attenuation, 15 dB Digital Back Off per Tone, f1 = 50.5 MHz, f2 = 55.5 MHz

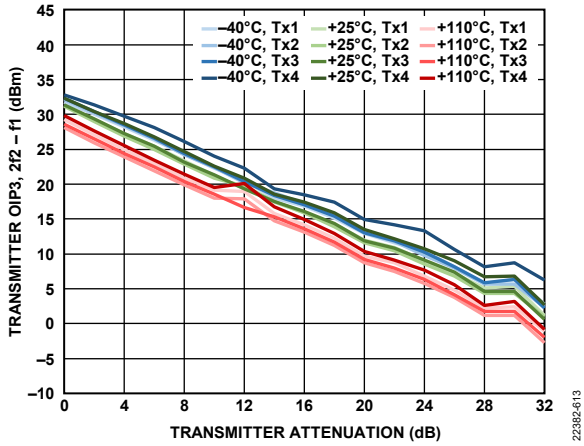

Figure 15. Transmitter OIP3, 2f2 - f1 vs. Transmitter Attenuation, 15 dB Digital Back Off per Tone, f1 = 50.5 MHz, f2 = 55.5 MHz

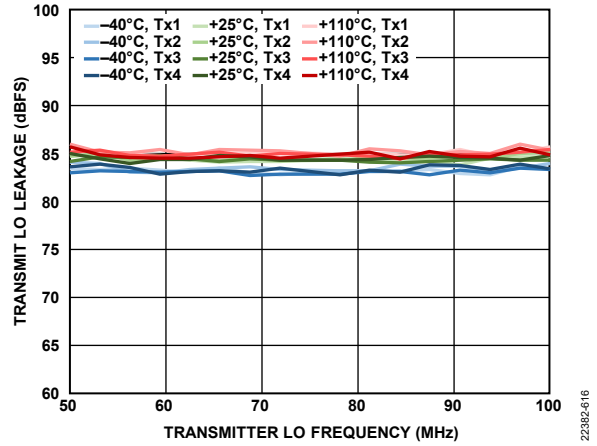

Figure 18. Transmitter LO Leakage vs. Transmitter LO Frequency

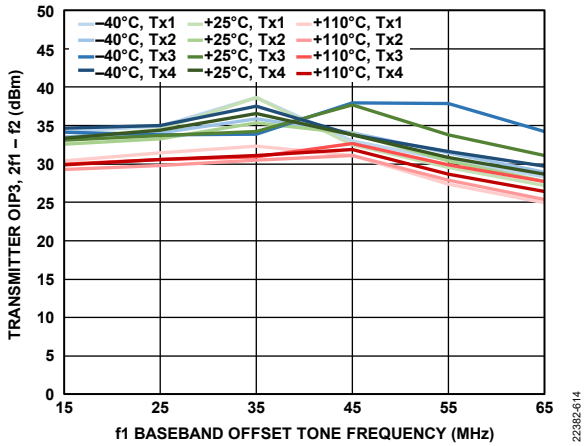

Figure 16. Transmitter OIP3, 2f1 - f2 vs. f1 Baseband Offset Tone Frequency, f2 = f1 + 5 MHz, 15 dB Digital Back Off per Tone

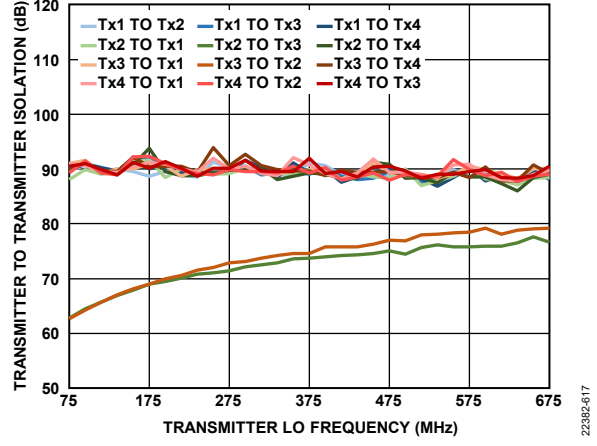

Figure 19. Transmitter to Transmitter Isolation vs. Transmitter LO Frequency

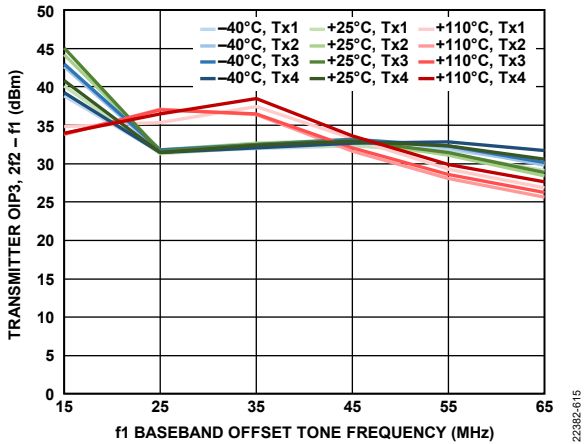

Figure 17. Transmitter OIP3, 2f2 - f1 vs. f1 Baseband Offset Tone Frequency, f2 = f1 + 5 MHz, 15 dB Digital Back Off per Tone

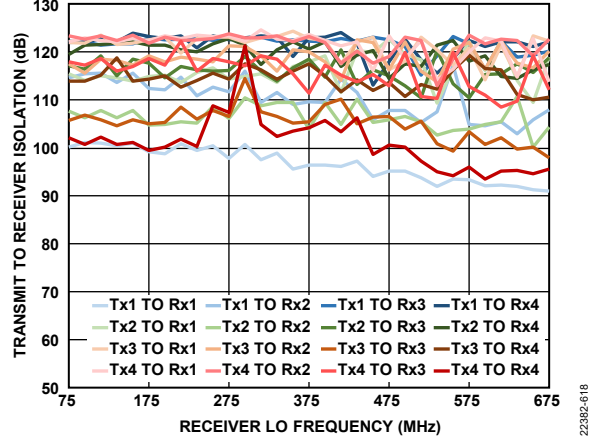

Figure 20. Transmitter to Receiver Isolation vs. Receiver LO Frequency

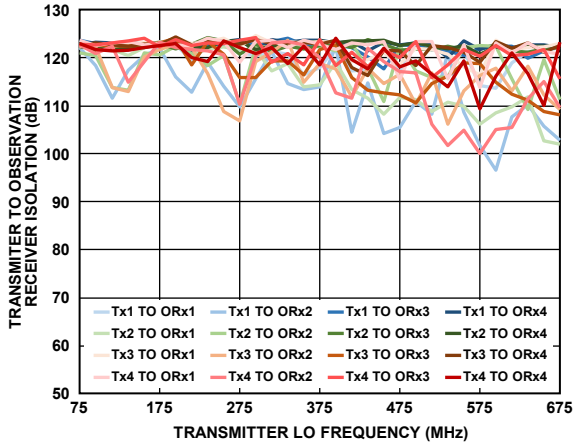

Figure 21. Transmitter to Observation Receiver Isolation vs. Transmitter LO Frequency

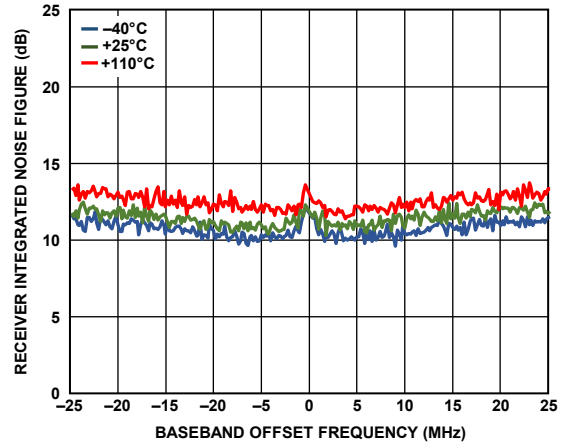

Figure 24. Receiver Integrated Noise Figure vs. Baseband Offset Frequency, 62.5 MHz Bandwidth, Sample Rate = 76.8 MSPS, Integrated in 200 kHz Steps

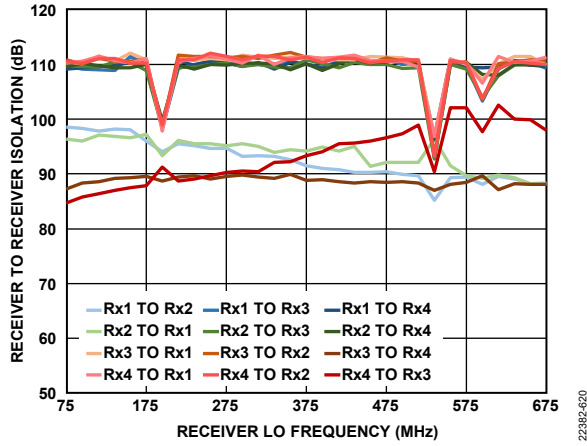

Figure 22. Receiver to Receiver Isolation vs. Receiver LO Frequency

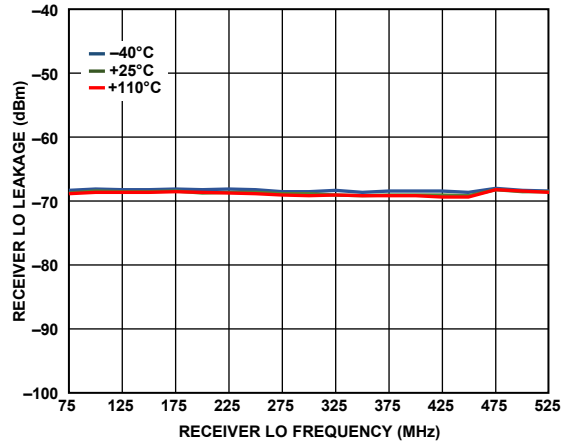

Figure 25. Receiver LO Leakage vs. Receiver LO Frequency, Attenuation = 0 dB, Sample Rate = 76.8 MSPS

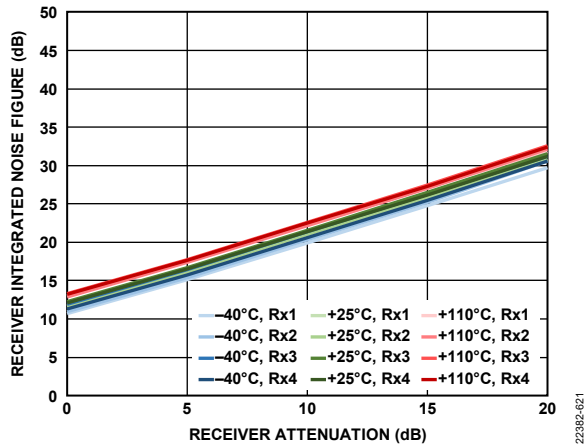

Figure 23. Receiver Integrated Noise Figure vs. Receiver Attenuation, 62.5 MHz Bandwidth, Sample Rate = 76.8 MSPS, Integration Bandwidth = 500 kHz to 100 MHz

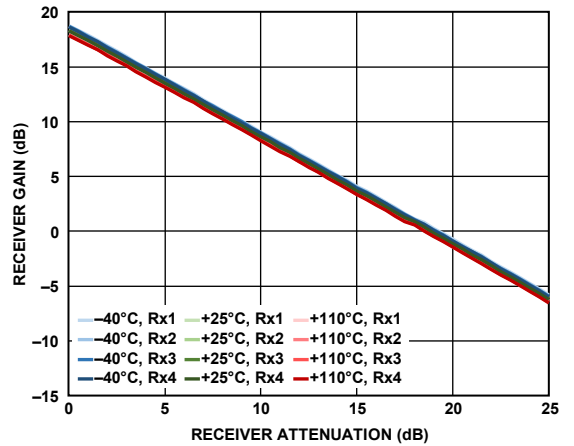

Figure 26. Receiver Gain vs. Receiver Attenuation, 20 MHz Offset, 62.5 MHz Bandwidth, Sample Rate = 76.8 MSPS

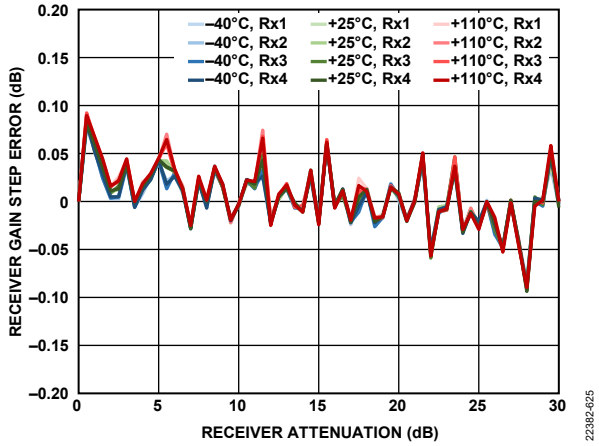

Figure 27. Receiver Gain Step Error vs. Receiver Attenuation, 10 MHz Offset, -5 dBFS Input Signal

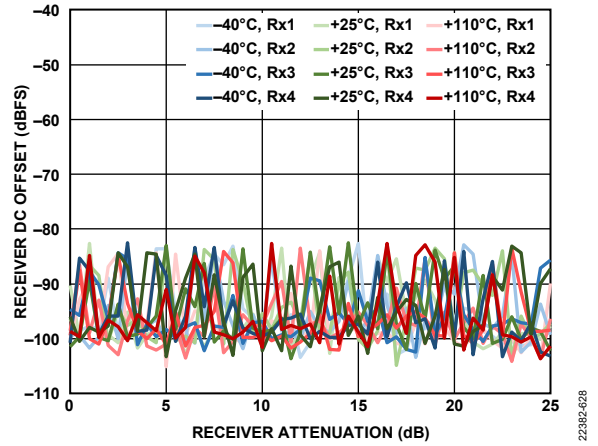

Figure 30. Receiver DC Offset vs. Receiver Attenuation, 10 MHz Offset, -5 dBFS Input Signal

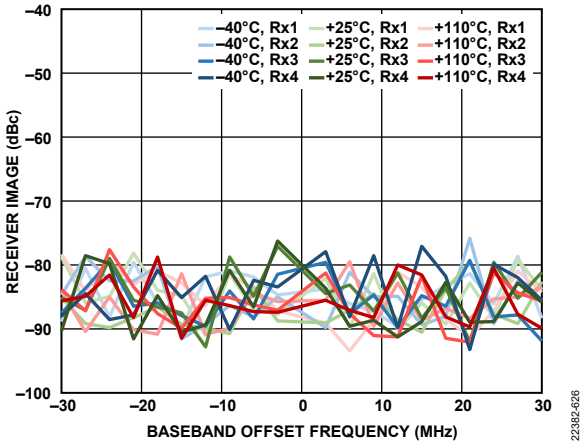

Figure 28. Receiver Image vs. Baseband Offset Frequency, Tracking Calibration Active, Sample Rate = 76.8 MSPS

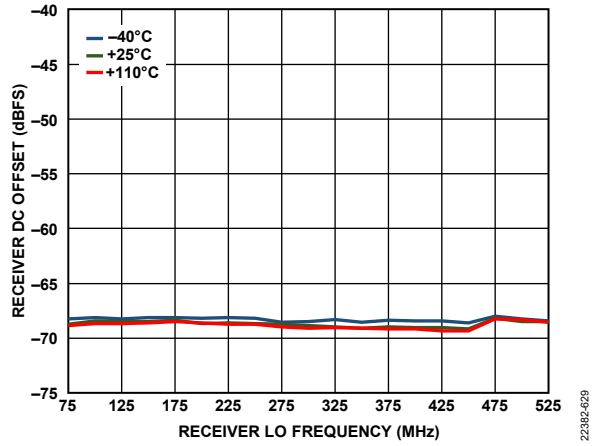

Figure 31. Receiver DC Offset vs. Receiver LO Frequency, 10 MHz Offset, -5 dBFS Input Signal

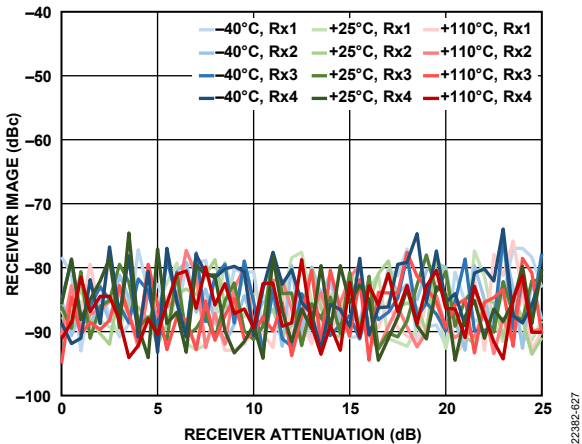

Figure 29. Receiver Image vs. Receiver Attenuation, 10 MHz Offset, Tracking Calibration Active, Sample Rate = 76.8 MSPS

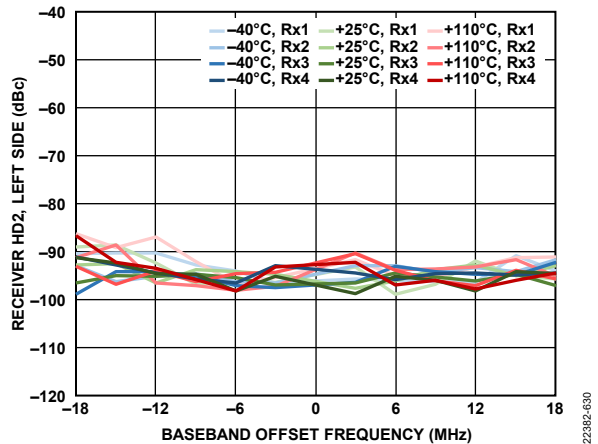

Figure 32. Receiver HD2, Left Side vs. Baseband Offset Frequency, -5 dBFS Input Signal, Distortion Tone Measured Left of 0 Hz (HD2 Canceller Enabled)

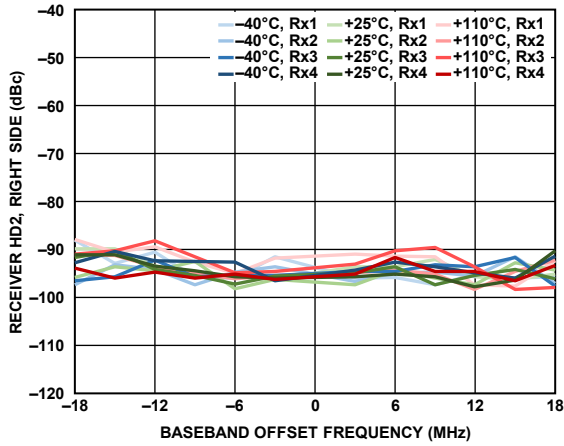

Figure 33. Receiver HD2, Right Side vs. Baseband Offset Frequency, -5 dBFS Input Signal, Distortion Tone Measured Right of 0 Hz (HD2 Canceller Enabled)

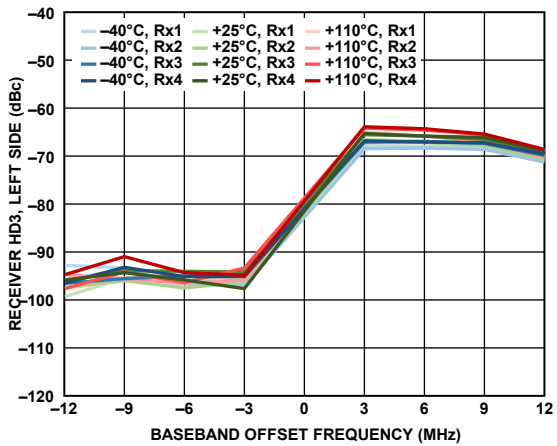

Figure 34. Receiver HD3, Left Side vs. Baseband Offset Frequency, -5 dBFS Input Signal, Distortion Tone Measured Left of 0 Hz

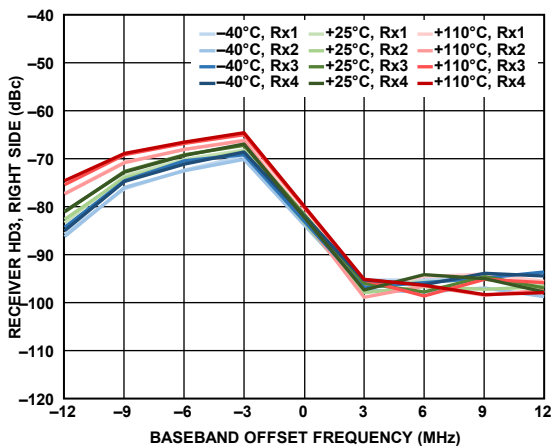

Figure 35. Receiver HD3, Right Side vs. Baseband Offset Frequency, -5 dBFS Input Signal, Distortion Tone Measured Right of 0 Hz

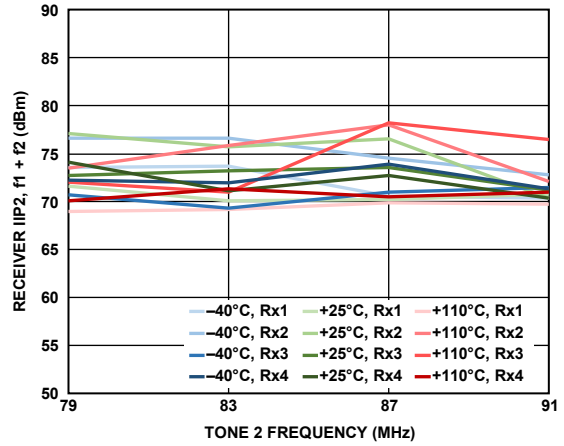

Figure 36. Receiver IIP2,  $f_1 + f_2$  vs. Tone 2 Frequency, Both Tones at -11 dBFS,  $f_1 = f_2 + 2$  MHz

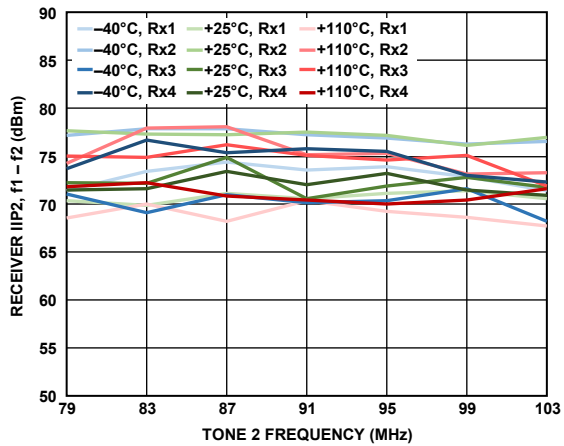

Figure 37. Receiver IIP2,  $f_1 - f_2$  vs. Tone 2 Frequency, Both Tones at -11 dBFS,  $f_1 = f_2 + 2$  MHz

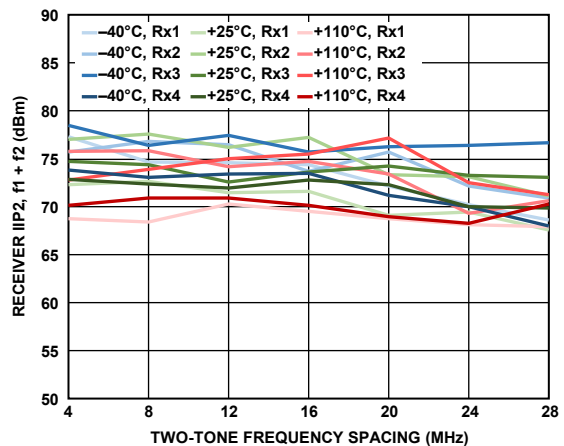

Figure 38. Receiver IIP2,  $f_1 + f_2$  vs. Two-Tone Frequency Spacing, Both Tones at -11 dBFS,  $f_2 = 2$  MHz

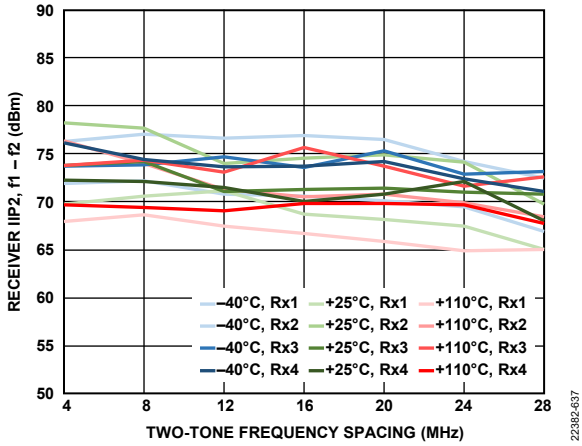

Figure 39. Receiver IIP2,  $f_1 - f_2$  vs. Two-Tone Frequency Spacing, Both Tones at  $-11$  dBFS,  $f_2 = 2$  MHz

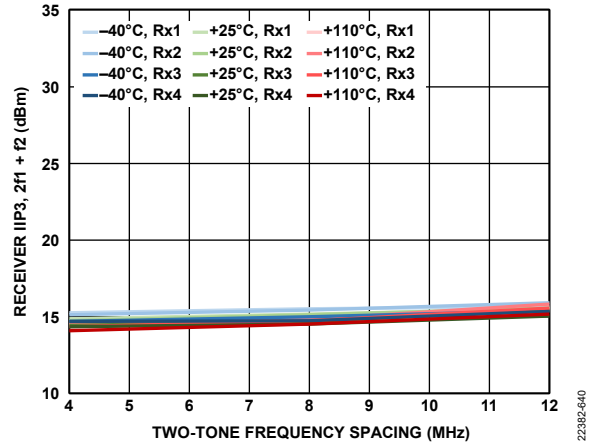

Figure 42. Receiver IIP3,  $2f_1 + f_2$  vs. Two-Tone Frequency Spacing, Both Tones at  $-11$  dBFS,  $f_2 = 2$  MHz

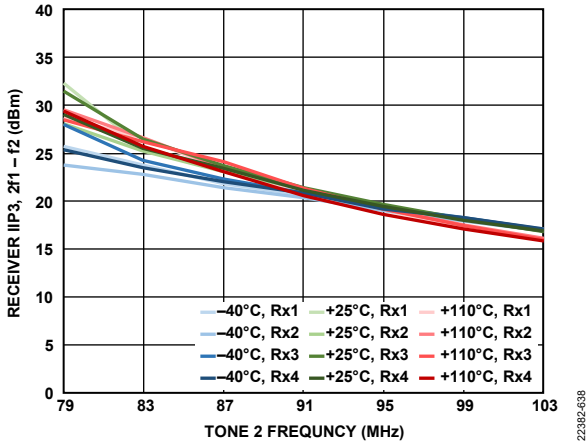

Figure 40. Receiver IIP3,  $2f_1 - f_2$  vs. Tone 2 Frequency, Both Tones at  $-11$  dBFS,  $f_1 = f_2 + 2$  MHz

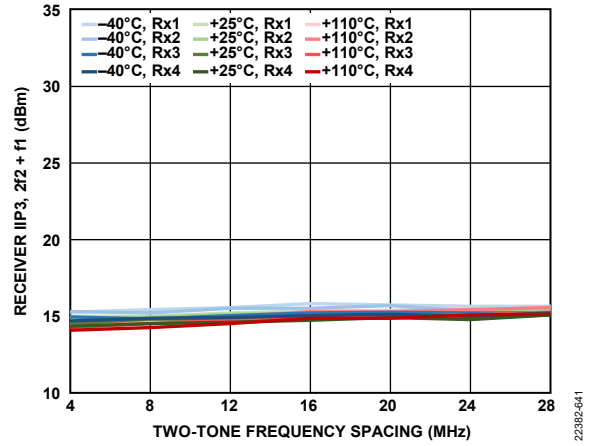

Figure 43. Receiver IIP3,  $2f_2 + f_1$  vs. Two-Tone Frequency Spacing, Both Tones at  $-11$  dBFS,  $f_2 = 2$  MHz

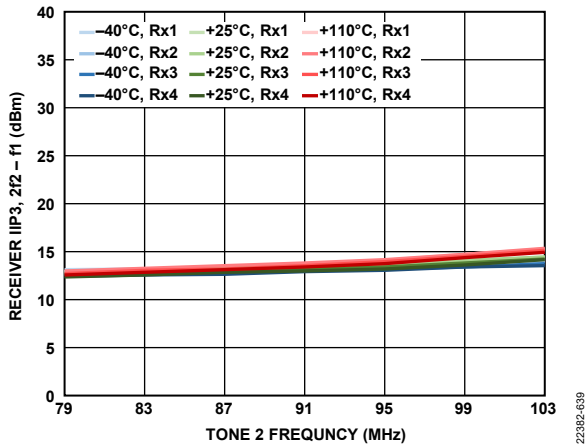

Figure 41. Receiver IIP3,  $2f_2 - f_1$  vs. Tone 2 Frequency, Both Tones at  $-11$  dBFS,  $f_1 = f_2 + 2$  MHz

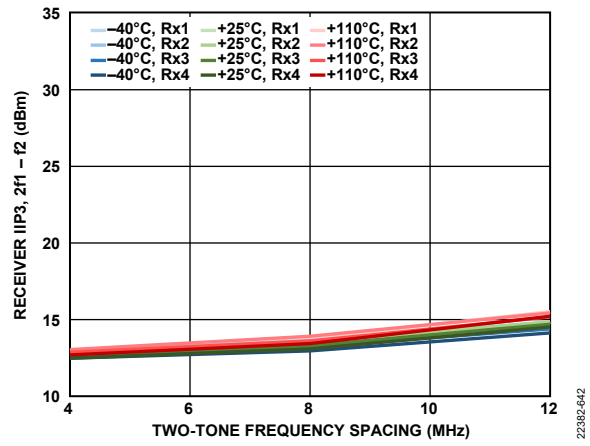

Figure 44. Receiver IIP3,  $2f_1 - f_2$  vs. Two-Tone Frequency Spacing, Both Tones at  $-11$  dBFS,  $f_2 = 2$  MHz

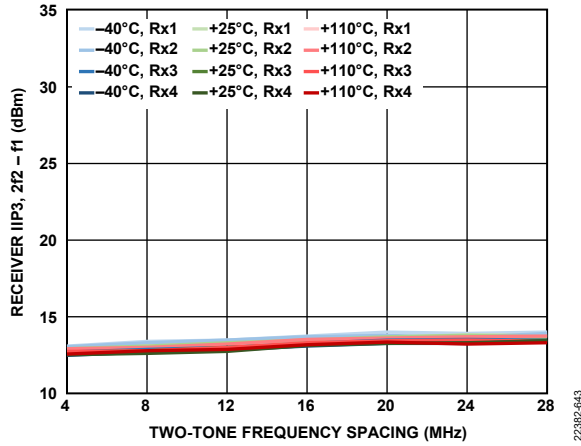

Figure 45. Receiver IIP3, 2f2 - f1 vs. Two-Tone Frequency Spacing, Both Tones at -11 dBFS, f2 = 2 MHz

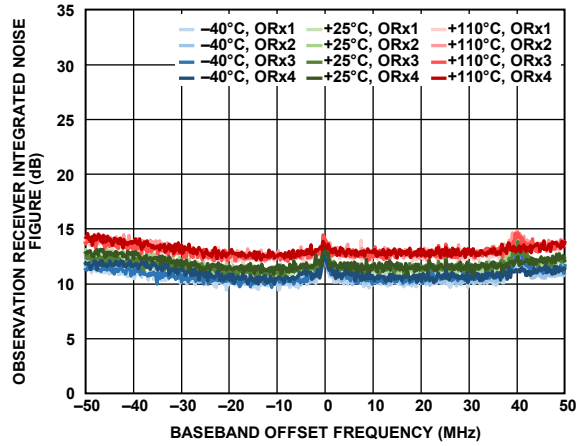

Figure 48. Observation Receiver Integrated Noise Figure vs. Baseband Offset Frequency, 141 MHz Bandwidth, Sample Rate = 153.6 MSPS, Integrated in 200 kHz Steps

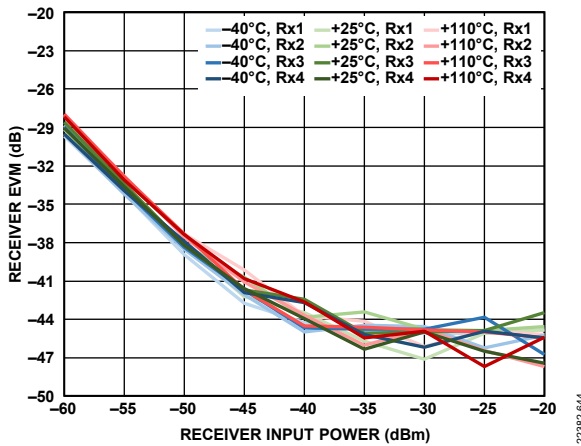

Figure 46. Receiver Error Vector Magnitude vs. Receiver Input Power, 20 MHz LTE Signal Centered at LO Frequency, Sample Rate = 153.6 MSPS, Loop Filter Bandwidth = 50 kHz, Loop Filter Phase Margin = 40°

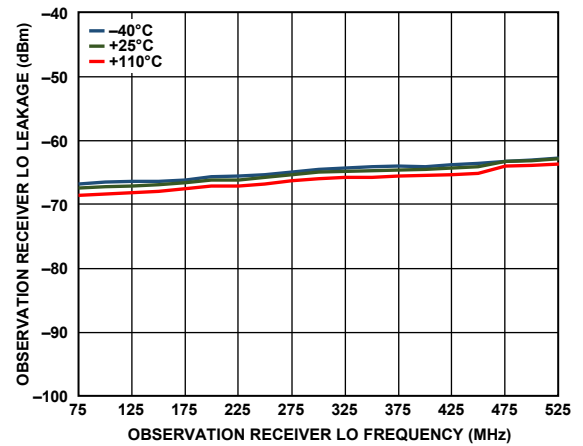

Figure 49. Observation Receiver LO Leakage vs. Observation Receiver LO Frequency, Attenuation = 0 dB, Sample Rate = 153.6 MSPS

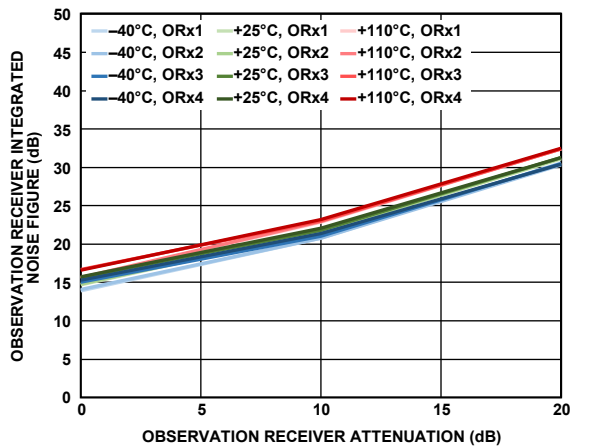

Figure 47. Observation Receiver (ORx) Integrated Noise Figure vs. Observation Receiver Attenuation, 141 MHz Bandwidth, Sample Rate = 153.6 MSPS, Integration Bandwidth = 500 kHz to 245.76 MHz

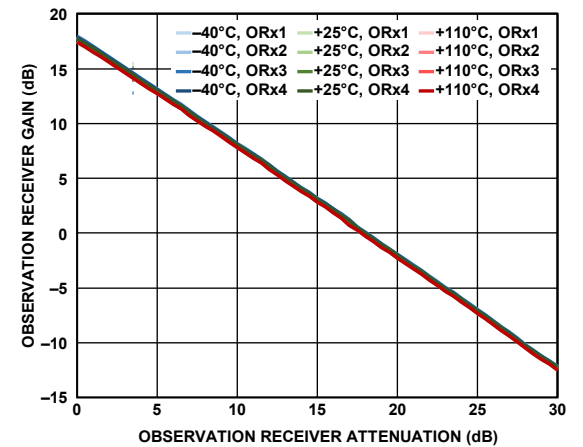

Figure 50. Observation Receiver Gain vs. Observation Receiver Attenuation, 45 MHz Offset, 141 MHz Bandwidth, Sample Rate = 153.6 MSPS

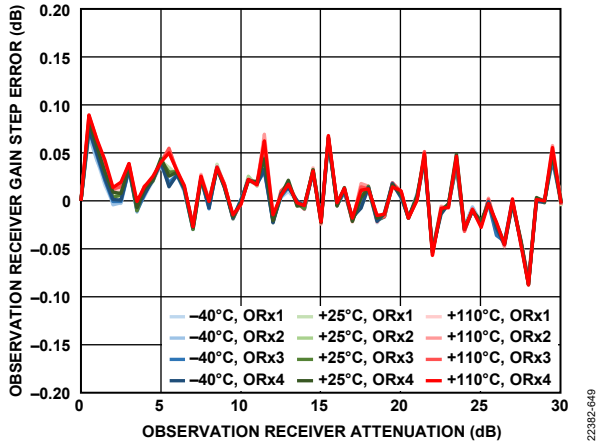

Figure 51. Observation Receiver Gain Step Error vs. Observation Receiver Attenuation, 45 MHz Offset, -10 dBFS Input Signal

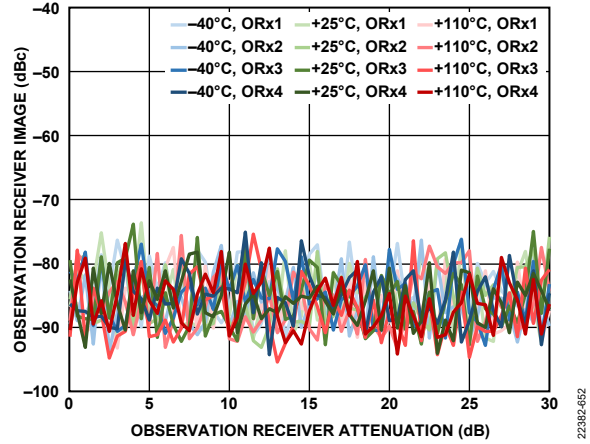

Figure 54. Observation Receiver Image vs. Observation Receiver Attenuation, 45 MHz Offset, Tracking Calibration Active, Sample Rate = 153.6 MSPS

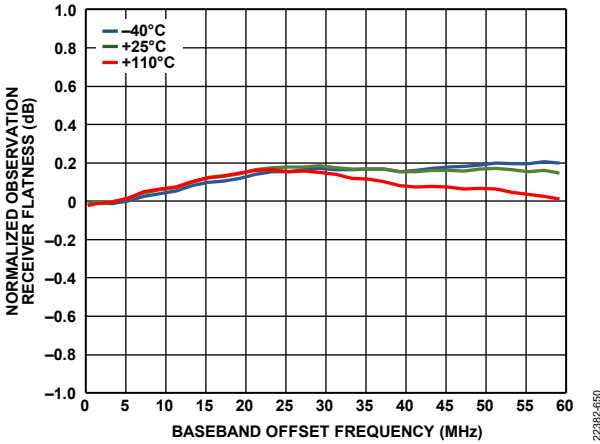

Figure 52. Normalized Observation Receiver Flatness vs. Baseband Offset Frequency, -10 dBFS Input Signal

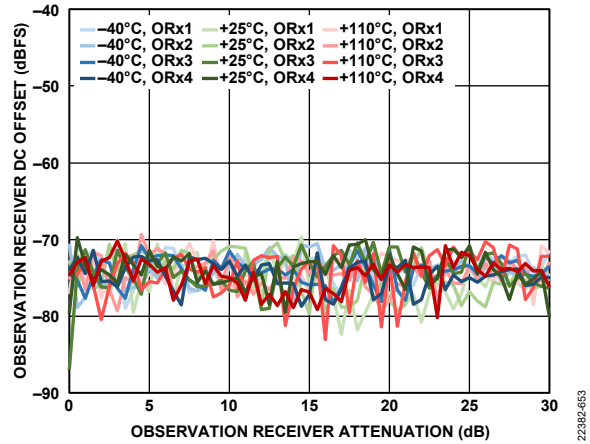

Figure 55. Observation Receiver DC Offset vs. Observation Receiver Attenuation, 45 MHz Offset, -10 dBFS Input Signal

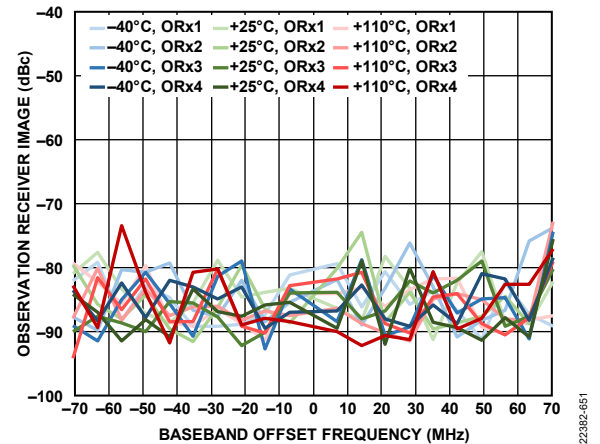

Figure 53. Observation Receiver Image vs. Baseband Offset Frequency, Tracking Calibration Active, Sample Rate = 153.6 MSPS

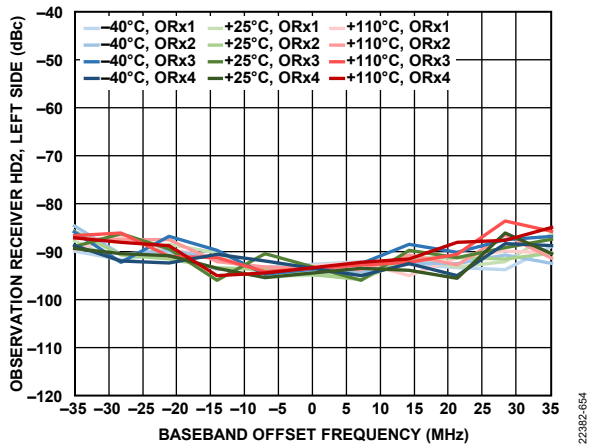

Figure 56. Observation Receiver HD2, Left Side vs. Baseband Offset Frequency, -10 dBFS Input Signal, Distortion Tone Measured Left of 0 Hz



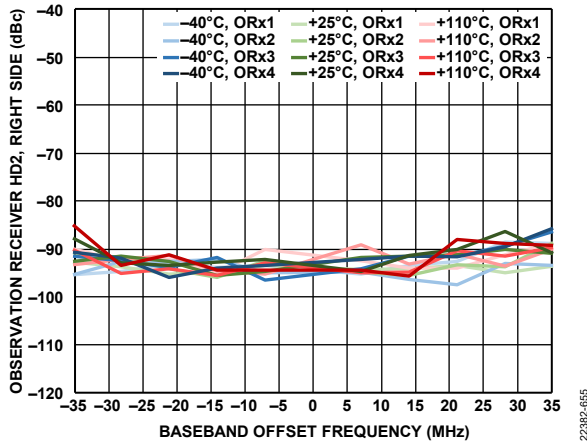

Figure 57. Observation Receiver HD2, Right Side vs. Baseband Offset Frequency, -10 dBFS Input Signal, Distortion Tone Measured Right of 0 Hz

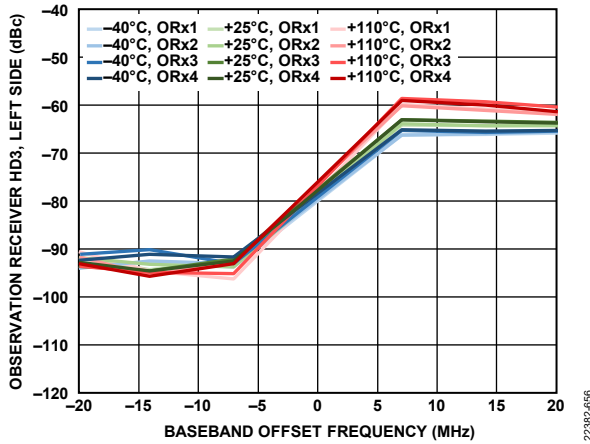

Figure 58. Observation Receiver HD3, Left Side vs. Baseband Offset Frequency, -10 dBFS Input Signal, Distortion Tone Measured Left of 0 Hz

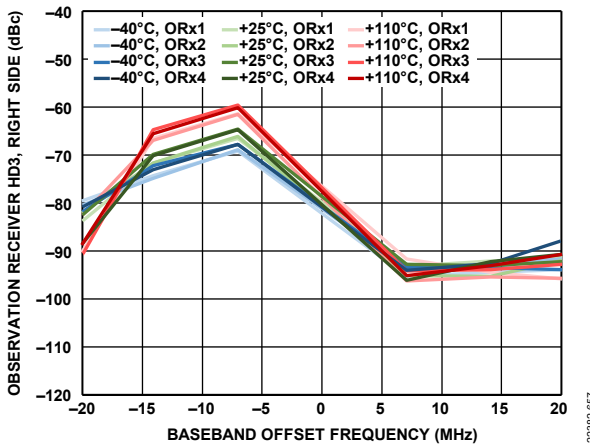

Figure 59. Observation Receiver HD3, Right Side vs. Baseband Offset Frequency, -10 dBFS Input Signal, Distortion Tone Measured Right of 0 Hz

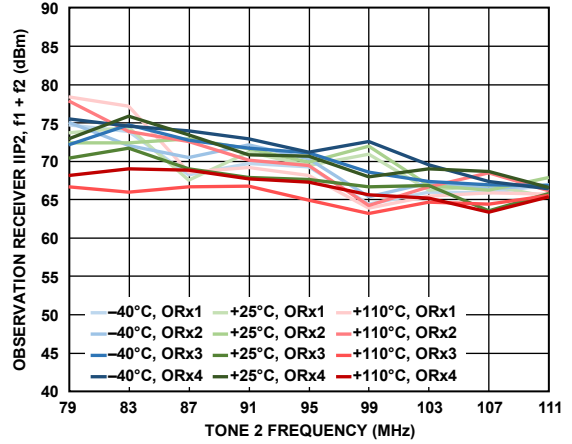

Figure 60. Observation Receiver IIP2,  $f_1 + f_2$  vs. Tone 2 Frequency, Both Tones at -13 dBFS,  $f_1 = f_2 + 2$  MHz

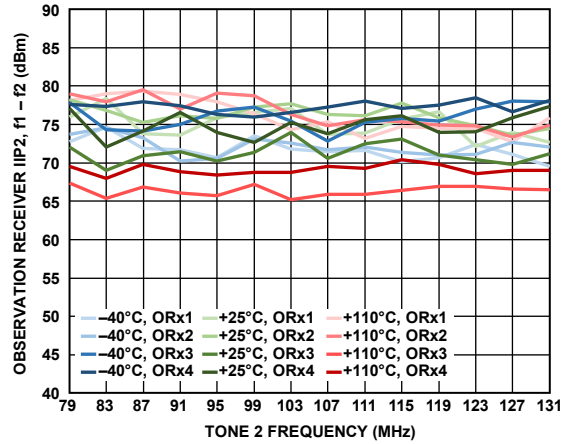

Figure 61. Observation Receiver IIP2,  $f_1 - f_2$  vs. Tone 2 Frequency, Both Tones at -13 dBFS,  $f_1 = f_2 + 2$  MHz

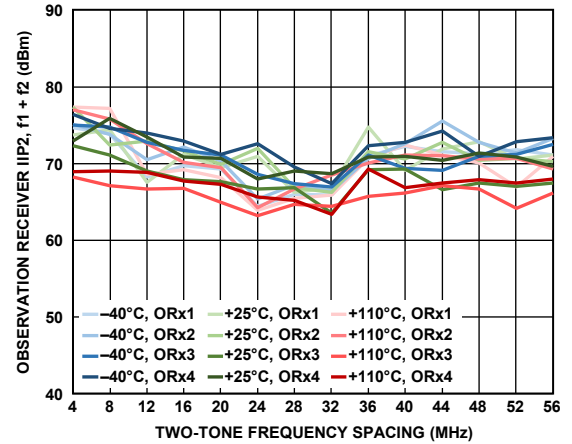

Figure 62. Observation Receiver IIP2,  $f_1 + f_2$  vs. Two-Tone Frequency Spacing, Both Tones at -13 dBFS,  $f_2 = 2$  MHz

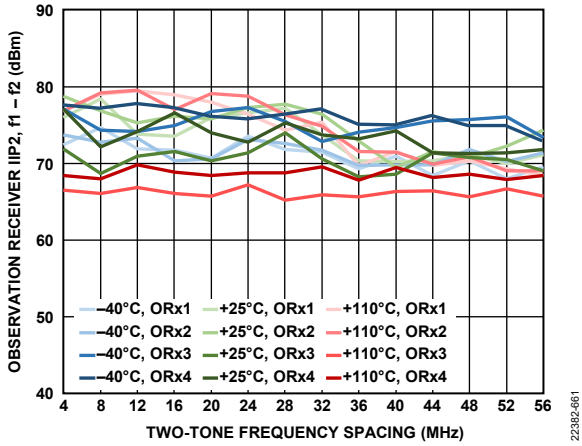

Figure 63. Observation Receiver IIP2,  $f_1 - f_2$  vs. Two-Tone Frequency Spacing, Both Tones at  $-13$  dBFS,  $f_2 = 2$  MHz

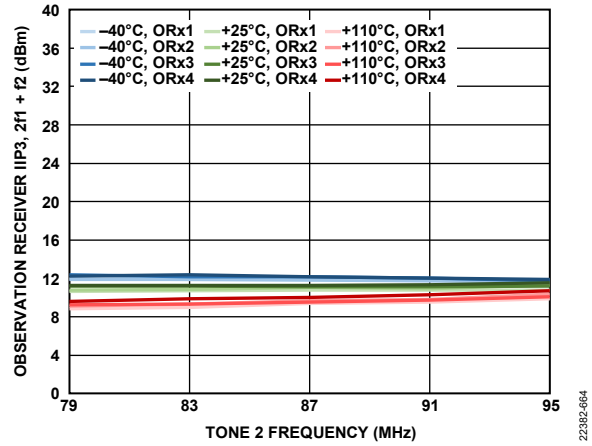

Figure 66. Observation Receiver IIP3,  $2f_1 + f_2$  vs. Tone 2 Frequency, Both Tones at  $-13$  dBFS,  $f_1 = f_2 + 2$  MHz

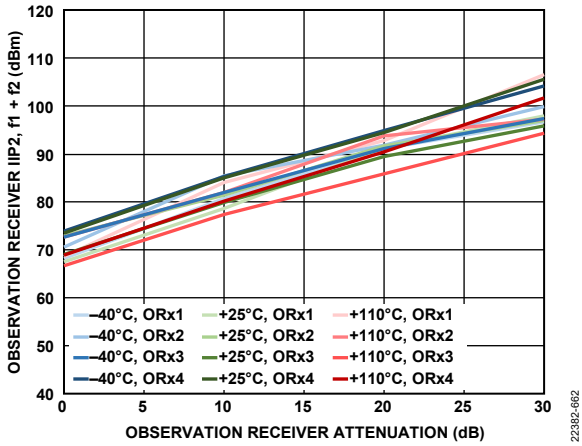

Figure 64. Observation Receiver IIP2,  $f_1 + f_2$  vs. Observation Receiver Attenuation, Both Tones at  $-13$  dBFS,  $f_1 = 102$  MHz,  $f_2 = 2$  MHz

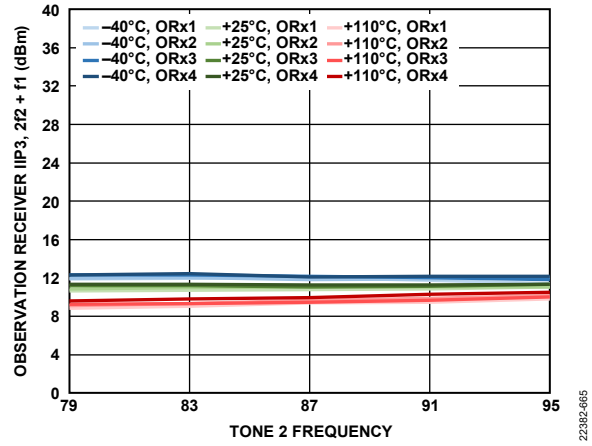

Figure 67. Observation Receiver IIP3,  $2f_2 + f_1$  vs. Tone 2 Frequency, Both Tones at  $-13$  dBFS,  $f_1 = f_2 + 2$  MHz

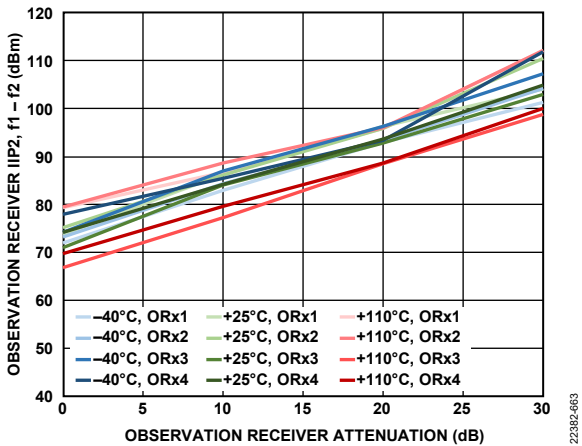

Figure 65. Observation Receiver IIP2,  $f_1 - f_2$  vs. Observation Receiver Attenuation, Both Tones at  $-13$  dBFS,  $f_1 = 102$  MHz,  $f_2 = 2$  MHz

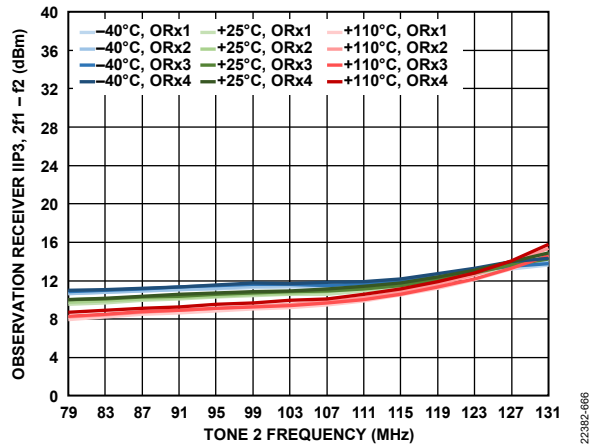

Figure 68. Observation Receiver IIP3,  $2f_1 - f_2$  vs. Tone 2 Frequency, Both Tones at  $-13$  dBFS,  $f_1 = f_2 + 2$  MHz

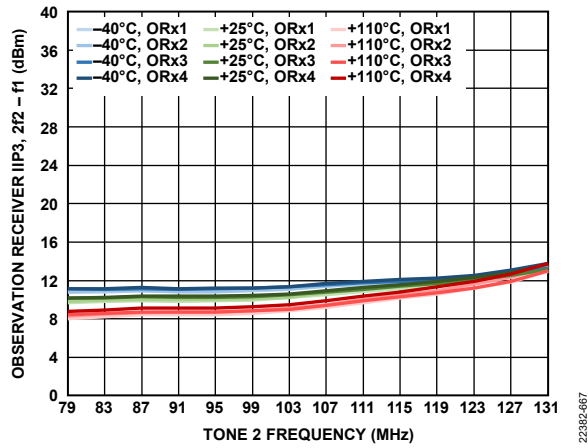

Figure 69. Observation Receiver IIP3,  $2f_2 - f_1$  vs. Tone 2 Frequency, Both Tones at  $-13$  dBFS,  $f_1 = f_2 + 2$  MHz

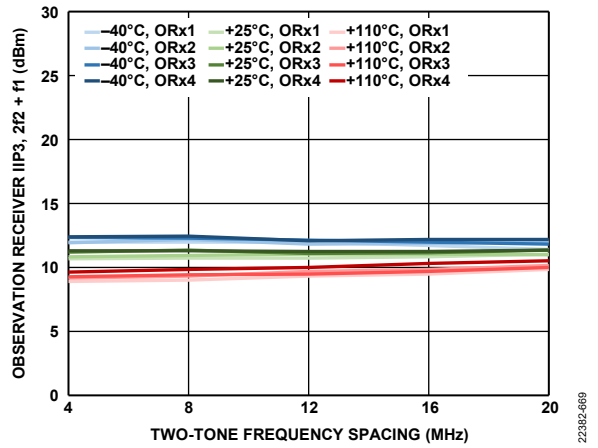

Figure 71. Observation Receiver IIP3,  $2f_2 + f_1$  vs. Two-Tone Frequency Spacing, Both Tones at  $-13$  dBFS,  $f_2 = 2$  MHz

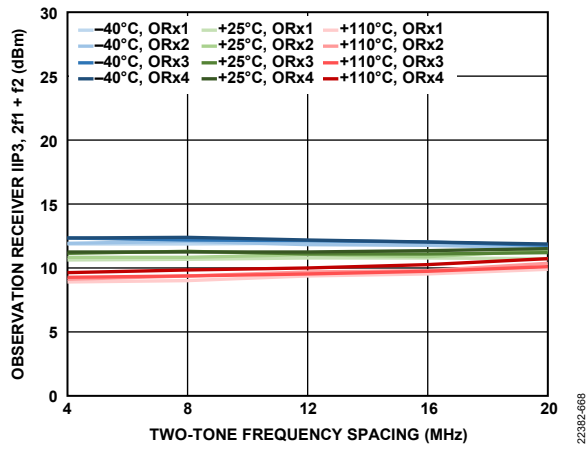

Figure 70. Observation Receiver IIP3,  $2f_1 + f_2$  vs. Two-Tone Frequency Spacing, Both Tones at  $-13$  dBFS,  $f_2 = 2$  MHz

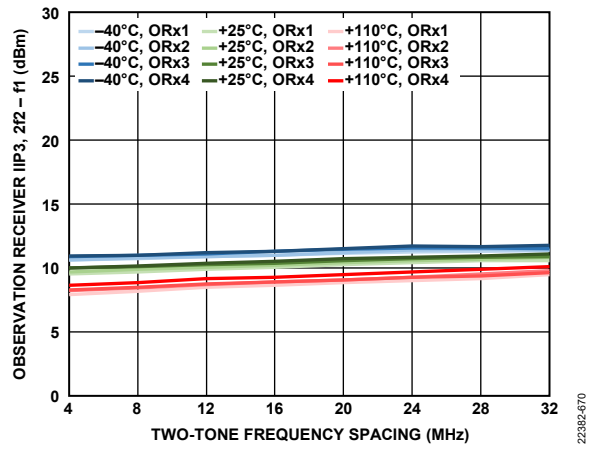

Figure 72. Observation Receiver IIP3,  $2f_1 - f_2$  vs. Two-Tone Frequency Spacing, Both Tones at  $-13$  dBFS,  $f_2 = 2$  MHz

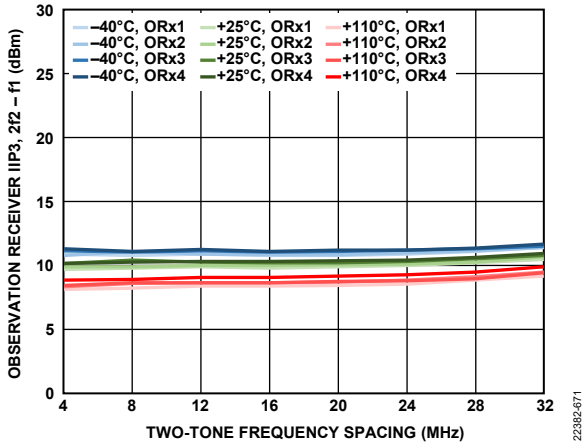

Figure 73. Observation Receiver IIP3, 2f2 – f1 vs. Two-Tone Frequency Spacing, Both Tones at –13 dBFS, f2 = 2 MHz

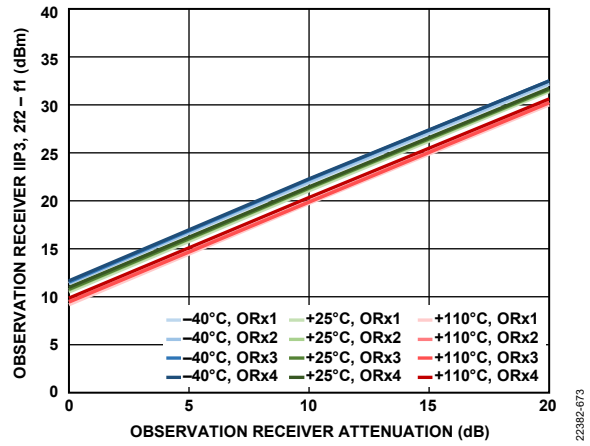

Figure 75. Observation Receiver IIP3, 2f2 – f1 vs. Observation Receiver Attenuation, Both Tones at –13 dBFS, f1 = 122 MHz, f2 = 2 MHz

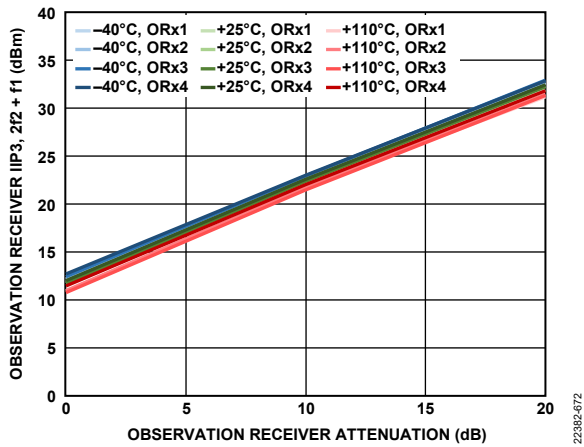

Figure 74. Observation Receiver IIP3, 2f2 + f1 vs. Observation Receiver Attenuation, Both Tones at –13 dBFS, f1 = 122 MHz, f2 = 2 MHz

**800 MHz BAND**

Device configuration profile: receiver = 200 MHz bandwidth, I/Q rate = 245.76 MHz, transmitter = 200 MHz large signal bandwidth plus 450 MHz synthesis bandwidth, I/Q rate = 491.52 MHz, observation receiver (OR<sub>x</sub>) = 450 MHz bandwidth, I/Q rate = 491.52 MHz, device clock = 245.76 MHz, unless otherwise noted. The temperature settings refer to the die temperature. All LO frequencies set to 800 MHz, unless otherwise noted.

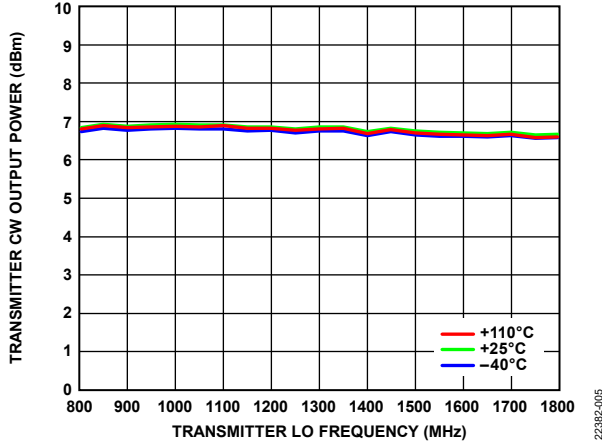

Figure 76. Transmitter Continuous Wave Output Power vs. Transmitter LO Frequency, 10 MHz Offset, 0 dB Attenuation

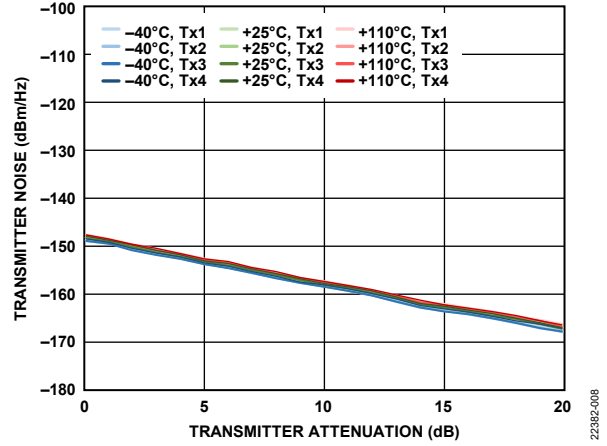

Figure 79. Transmitter Noise vs. Transmitter Attenuation, 10 MHz Offset

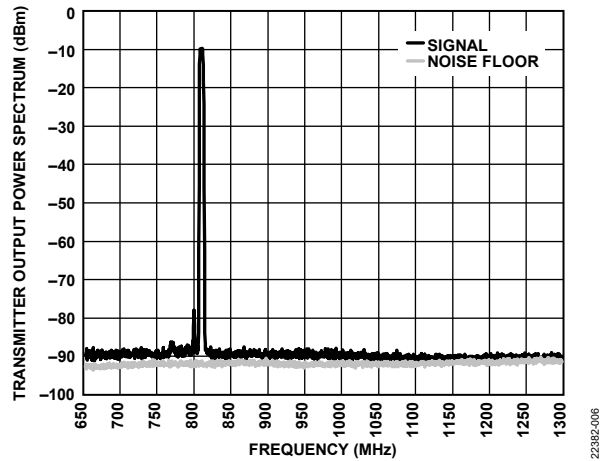

Figure 77. Transmitter Output Power Spectrum, Tx1, 5 MHz LTE, 10 MHz Offset, -10 dBFS RMS, 1 MHz Resolution Bandwidth, T<sub>j</sub> = 25°C

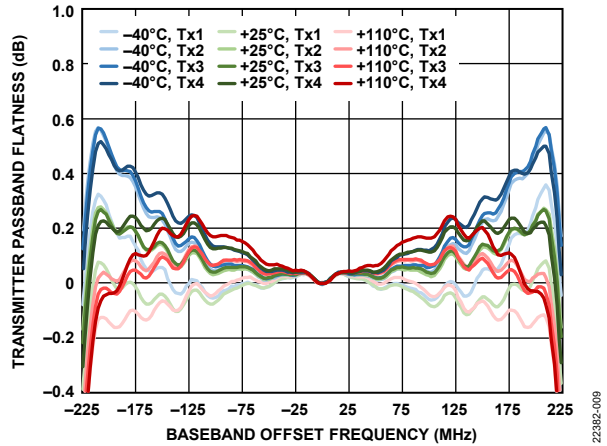

Figure 80. Transmitter Pass Band Flatness vs. Baseband Offset Frequency

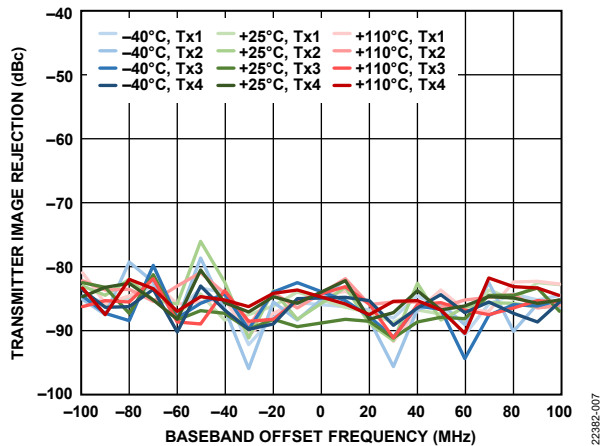

Figure 78. Transmitter Image Rejection Across Large Signal Bandwidth vs. Baseband Offset Frequency

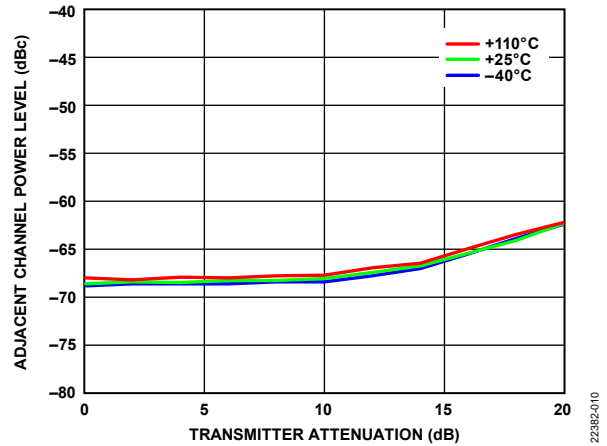

Figure 81. Adjacent Channel Power Level vs. Transmitter Attenuation, -10 MHz Baseband Offset, 20 MHz LTE, Peak to Average Ratio (PAR) = 12 dB

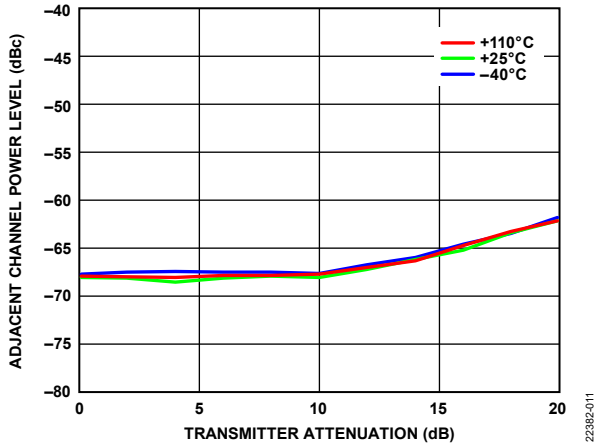

Figure 82. Adjacent Channel Power Level vs. Transmitter Attenuation, 90 MHz Baseband Offset, 20 MHz LTE, PAR = 12 dB

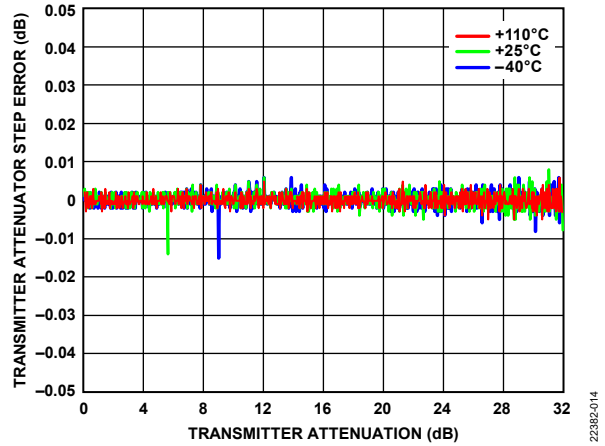

Figure 85. Transmitter Attenuator Step Error vs. Transmitter Attenuation, 10 MHz Offset

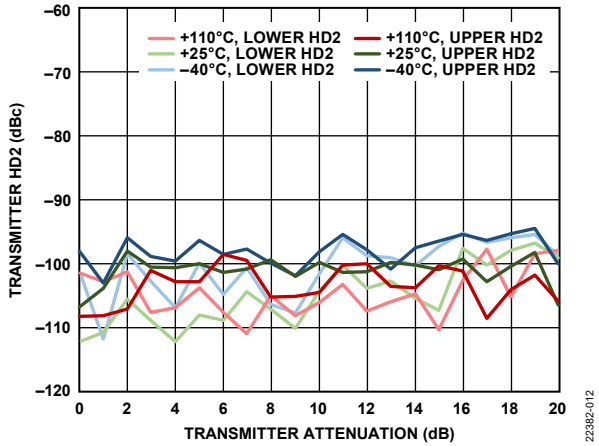

Figure 83. Transmitter Second-Order Harmonic Distortion (HD2) vs. Transmitter Attenuation, 10 MHz Offset

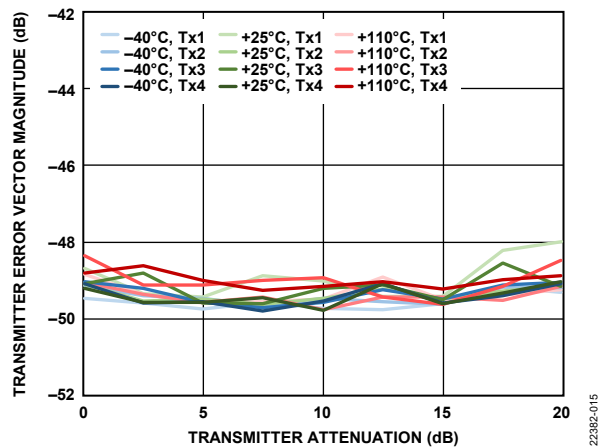

Figure 86. Transmitter Error Vector Magnitude vs. Transmitter Attenuation, 20 MHz LTE Signal Centered at LO Frequency, Sample Rate = 491.52 MSPS, Loop Filter Bandwidth = 50 kHz, Loop Filter Phase Margin = 85°

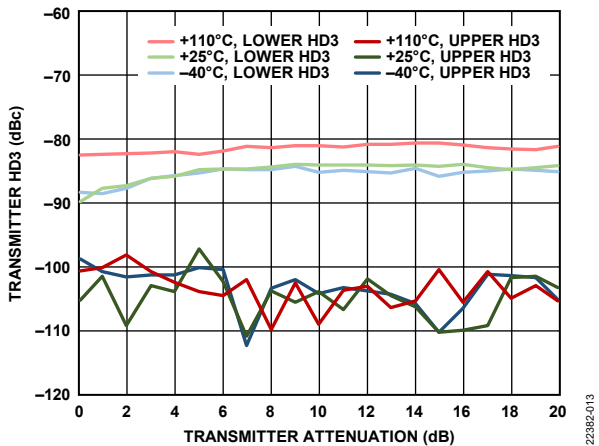

Figure 84. Transmitter Third-Order Harmonic Distortion (HD3) vs. Transmitter Attenuation, 10 MHz Offset

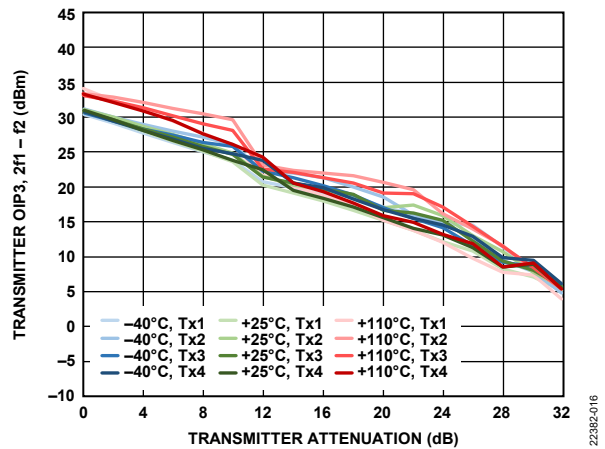

Figure 87. Transmitter OIP3, 2f1 - f2 vs. Transmitter Attenuation, 15 dB Digital Back Off per Tone, f1 = 50.5 MHz, f2 = 55.5 MHz

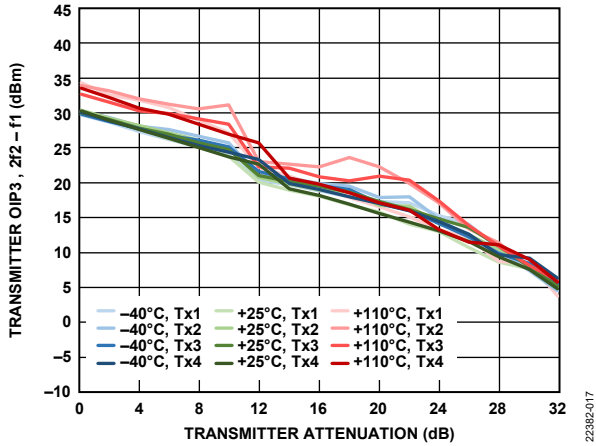

Figure 88. Transmitter OIP3, 2f2 – f1 vs. Transmitter Attenuation, 15 dB Digital Back Off per Tone, f1 = 50.5 MHz, f2 = 55.5 MHz

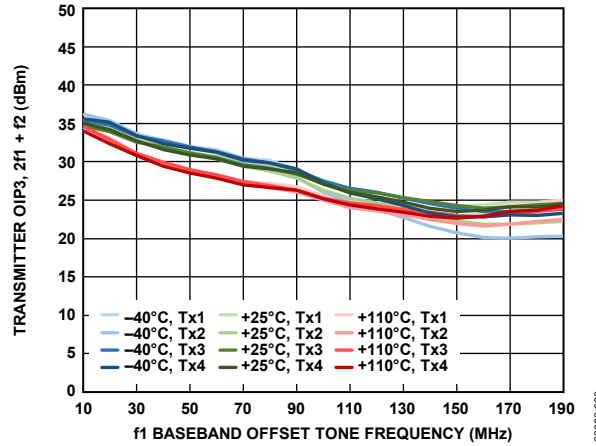

Figure 91. Transmitter OIP3, 2f1 + f2 vs. f1 Baseband Offset Tone Frequency, f2 = f1 + 5 MHz, 15 dB Digital Back Off per Tone

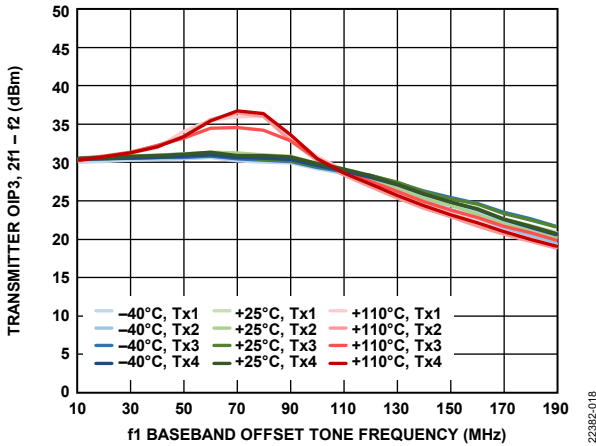

Figure 89. Transmitter OIP3, 2f1 – f2 vs. f1 Baseband Offset Tone Frequency, f2 = f1 + 5 MHz, 15 dB Digital Back Off per Tone

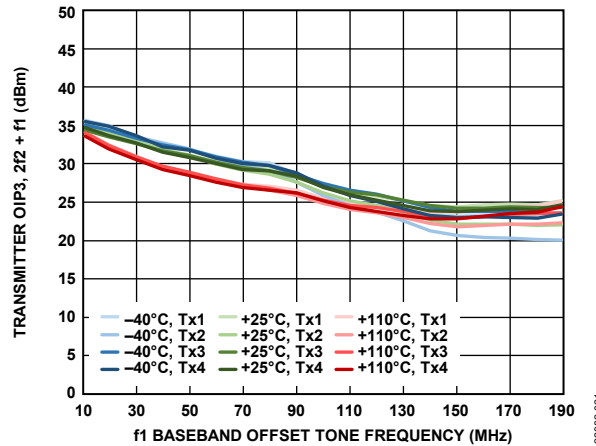

Figure 92. Transmitter OIP3, 2f2 + f1 vs. f1 Baseband Offset Tone Frequency, f2 = f1 + 5 MHz, 15 dB Digital Back Off per Tone

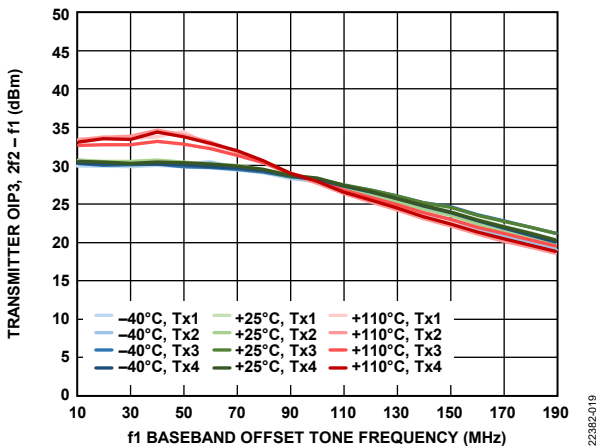

Figure 90. Transmitter OIP3, 2f2 – f1 vs. f1 Baseband Offset Tone Frequency, f2 = f1 + 5 MHz, 15 dB Digital Back Off per Tone

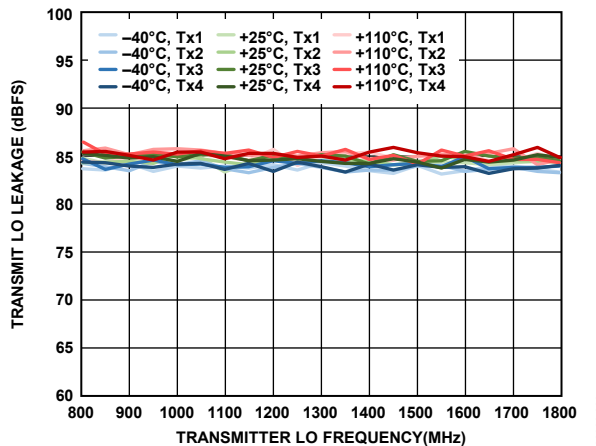

Figure 93. Transmitter LO Leakage vs. Transmitter LO Frequency

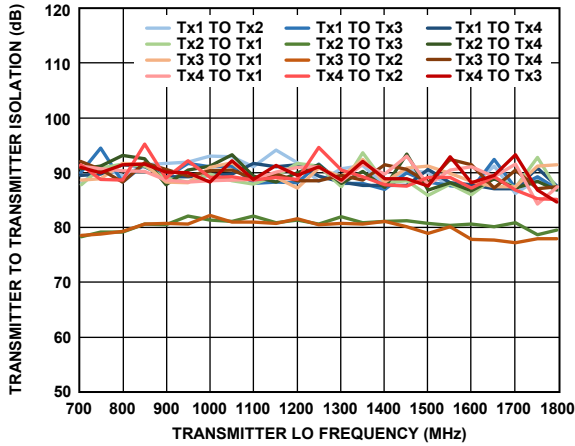

Figure 94. Transmitter to Transmitter Isolation vs. Transmitter LO Frequency

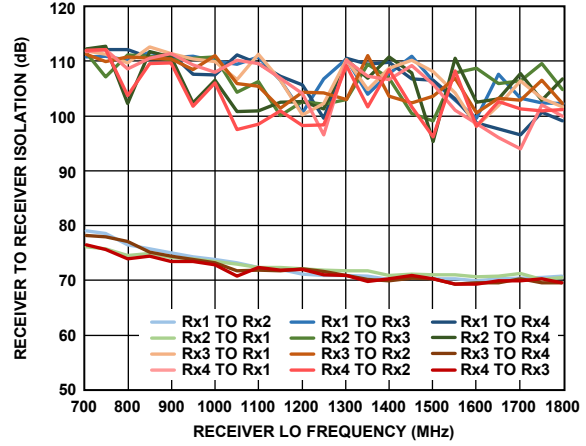

Figure 97. Receiver to Receiver Isolation vs. Receiver LO Frequency

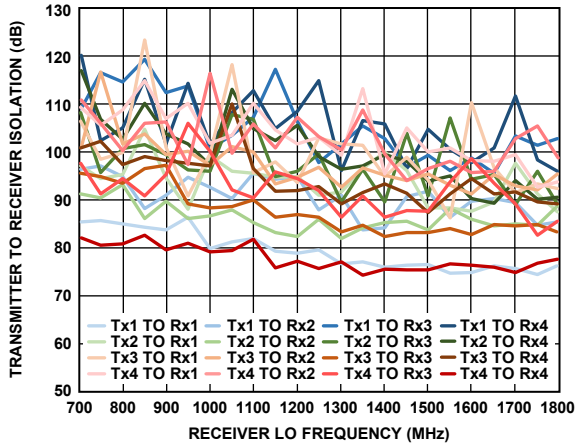

Figure 95. Transmitter to Receiver Isolation vs. Receiver LO Frequency

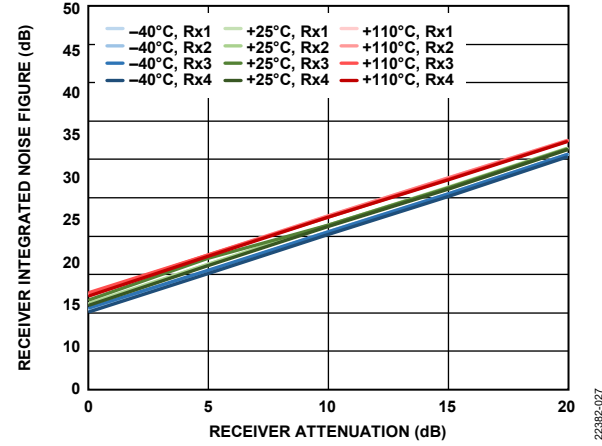

Figure 98. Receiver Integrated Noise Figure vs. Receiver Attenuation, 200 MHz Bandwidth, Sample Rate = 245.76 MSPS, Integration Bandwidth = 500 kHz to 100 MHz

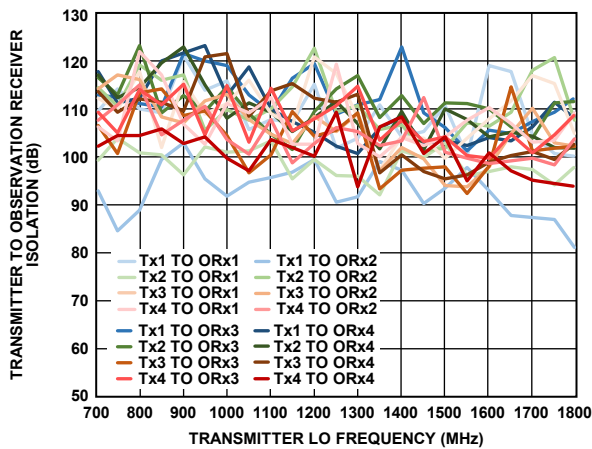

Figure 96. Transmitter to Observation Receiver Isolation vs. Transmitter LO Frequency

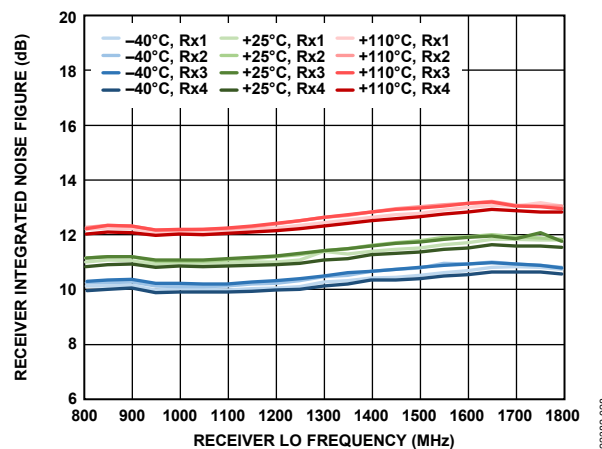

Figure 99. Receiver Integrated Noise Figure vs. Receiver LO Frequency, 200 MHz Bandwidth, Sample Rate = 245.76 MSPS, Integration Bandwidth = 500 kHz to 100 MHz



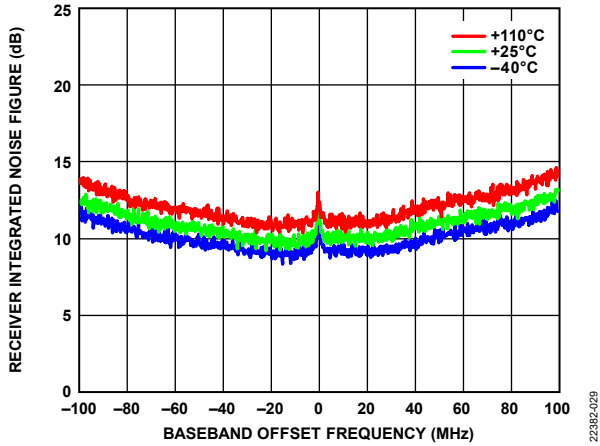

Figure 100. Receiver Integrated Noise Figure vs. Baseband Offset Frequency, 200 MHz Bandwidth, Sample Rate = 245.76 MSPS, Integrated in 200 kHz Steps

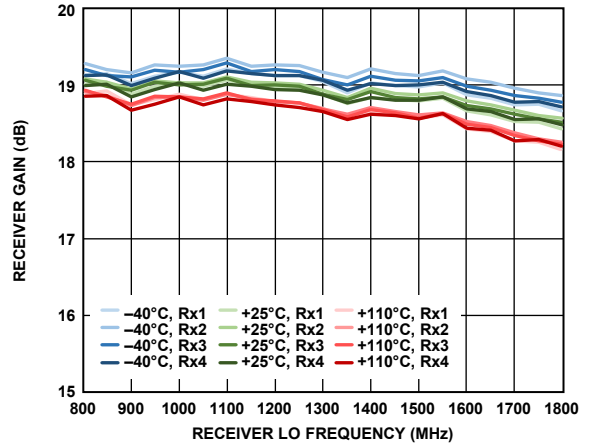

Figure 103. Receiver Gain vs. Receiver LO Frequency, 200 MHz Bandwidth, Sample Rate = 245.76 MSPS

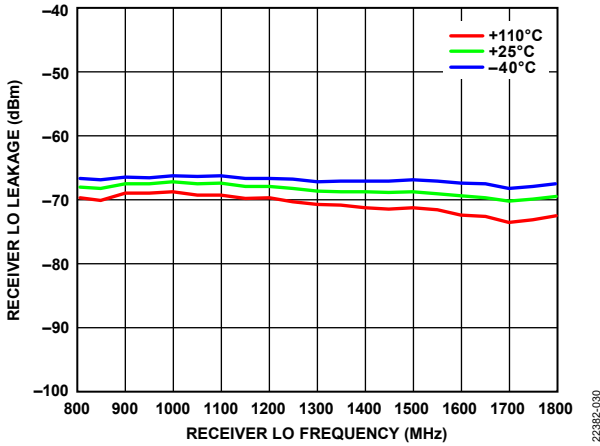

Figure 101. Receiver LO Leakage vs. Receiver LO Frequency, Attenuation = 0 dB, Sample Rate = 245.76 MSPS

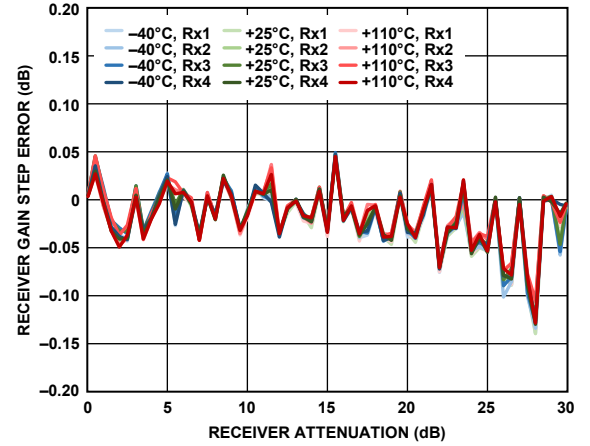

Figure 104. Receiver Gain Step Error vs. Receiver Attenuation, 20 MHz Offset, -5 dBFS Input Signal

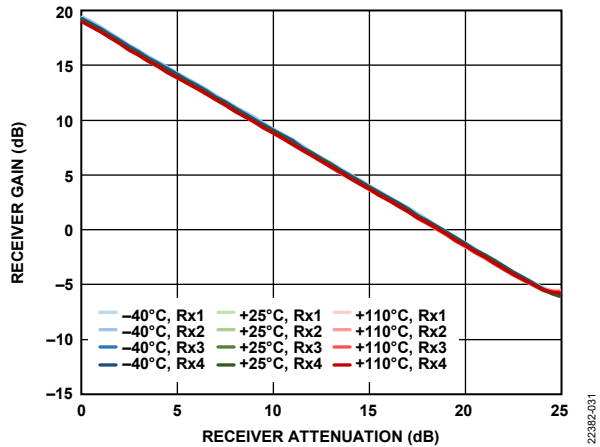

Figure 102. Receiver Gain vs. Receiver Attenuation, 20 MHz Offset, 200 MHz Bandwidth, Sample Rate = 245.76 MSPS

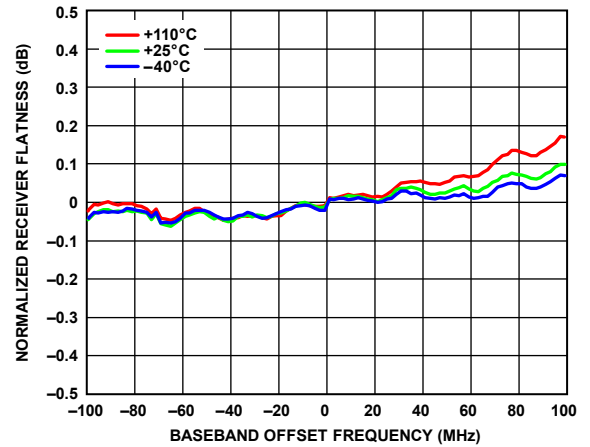

Figure 105. Normalized Receiver Flatness vs. Baseband Offset Frequency, -5 dBFS Input Signal

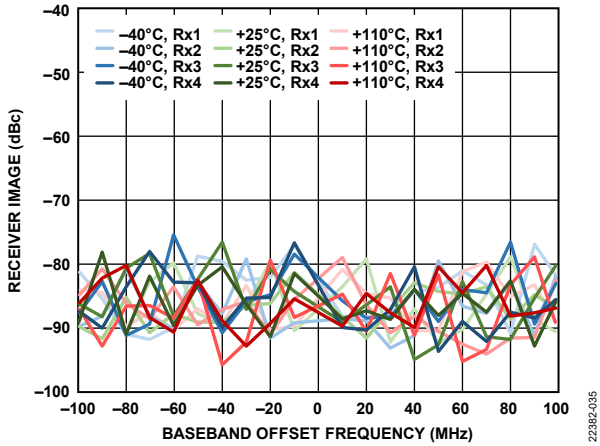

Figure 106. Receiver Image vs. Baseband Offset Frequency, Tracking Calibration Active, Sample Rate = 245.76 MSPS

22382-035

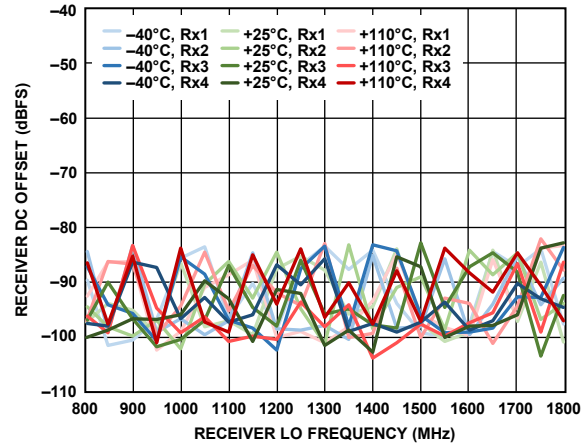

Figure 109. Receiver DC Offset vs. Receiver LO Frequency, 20 MHz Offset, -5 dBFS Input Signal

22382-038

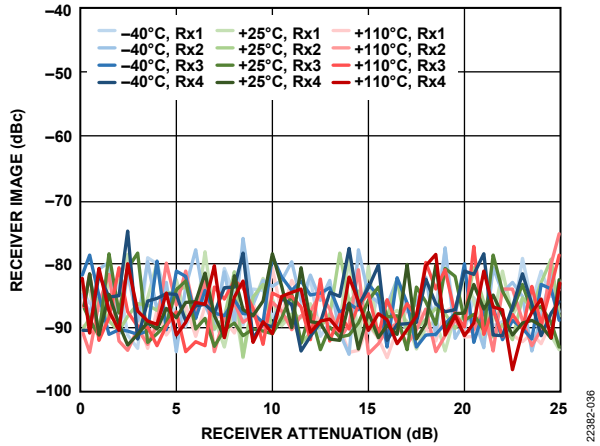

Figure 107. Receiver Image vs. Receiver Attenuation, 20 MHz Offset, Tracking Calibration Active, Sample Rate = 245.76 MSPS

22382-036

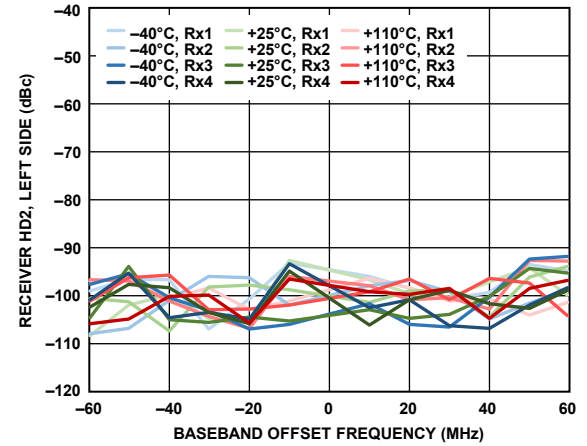

Figure 110. Receiver HD2, Left Side vs. Baseband Offset Frequency, -5 dBFS Input Signal, Distortion Tone Measured Left of 0 Hz (HD2 Canceller Enabled)

22382-039

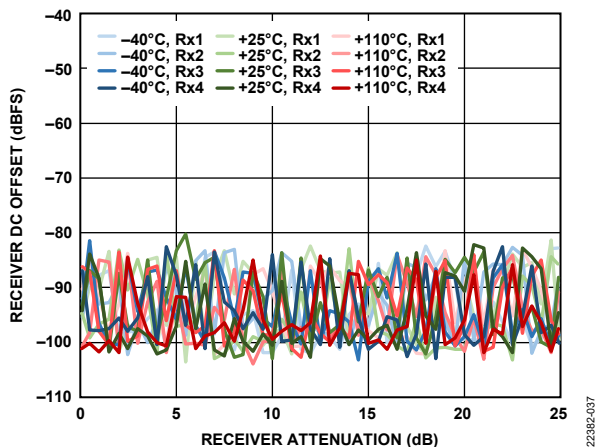

Figure 108. Receiver DC Offset vs. Receiver Attenuation, 20 MHz Offset, -5 dBFS Input Signal

22382-037

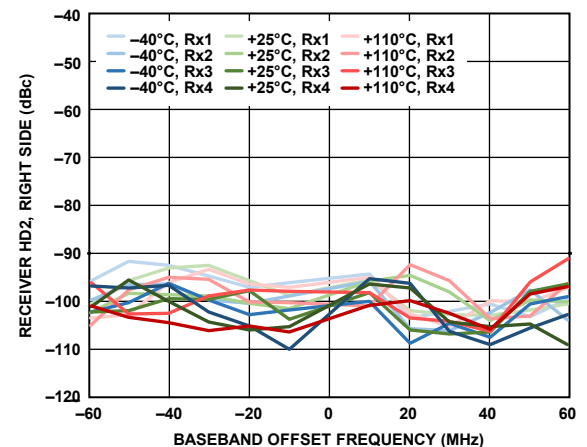

Figure 111. Receiver HD2, Right Side vs. Baseband Offset Frequency, -5 dBFS Input Signal, Distortion Tone Measured Right of 0 Hz (HD2 Canceller Enabled)

22382-040

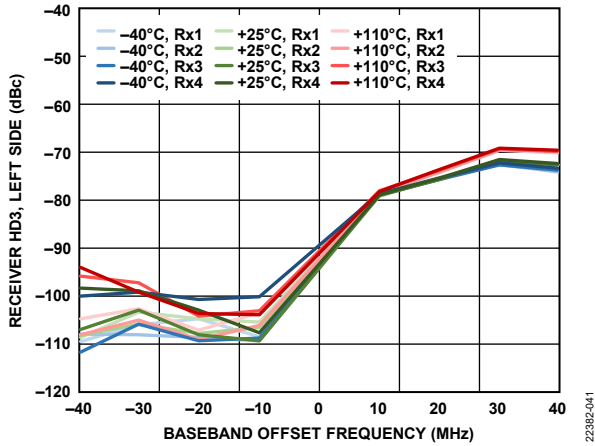

Figure 112. Receiver HD3, Left Side vs. Baseband Offset Frequency, -5 dBFS Input Signal, Distortion Tone Measured Left of 0 Hz

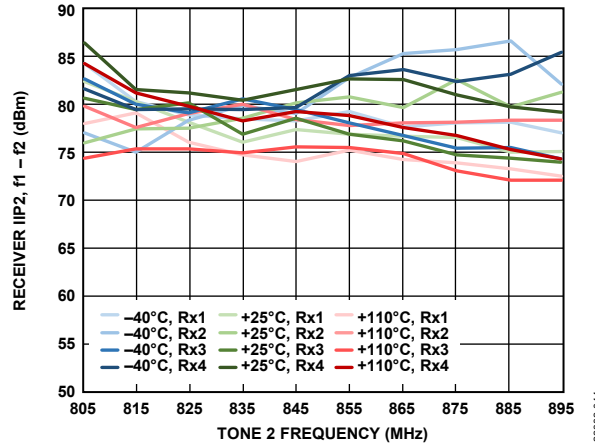

Figure 115. Receiver IIP2,  $f_1 - f_2$  vs. Tone 2 Frequency, Both Tones at -11 dBFS,  $f_1 = f_2 + 2$  MHz

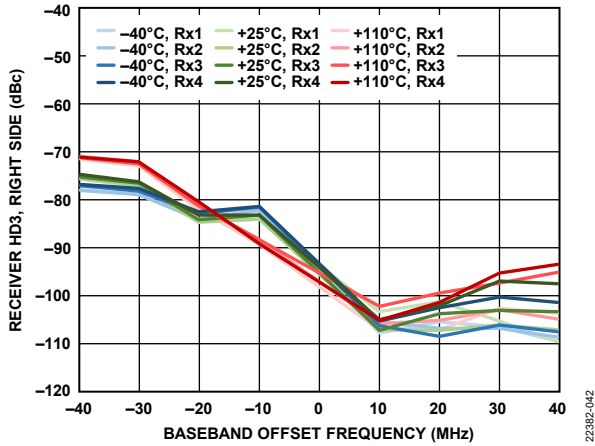

Figure 113. Receiver HD3, Right Side vs. Baseband Offset Frequency, -5 dBFS Input Signal, Distortion Tone Measured Right of 0 Hz

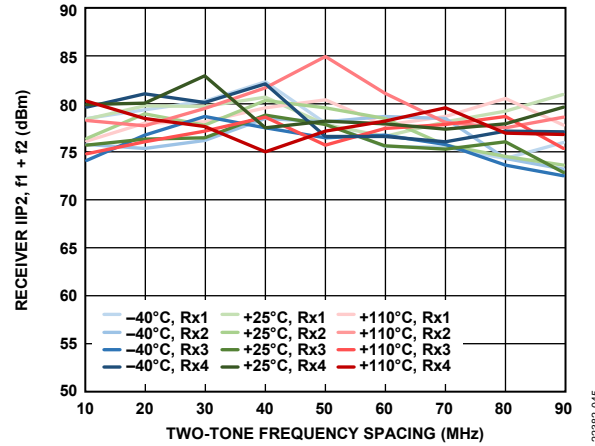

Figure 116. Receiver IIP2,  $f_1 + f_2$  vs. Two-Tone Frequency Spacing, Both Tones at -11 dBFS,  $f_2 = 2$  MHz

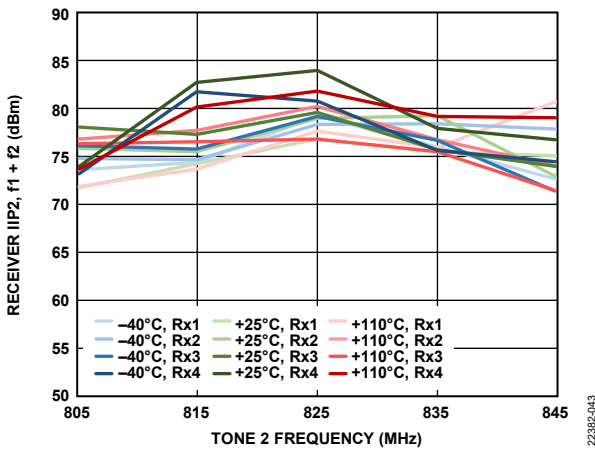

Figure 114. Receiver IIP2,  $f_1 + f_2$  vs. Tone 2 Frequency, Both Tones at -11 dBFS,  $f_1 = f_2 + 2$  MHz

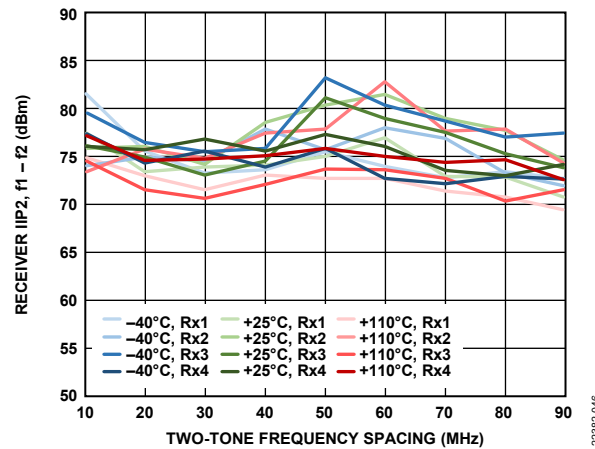

Figure 117. Receiver IIP2,  $f_1 - f_2$  vs. Two-Tone Frequency Spacing, Both Tones at -11 dBFS,  $f_2 = 2$  MHz

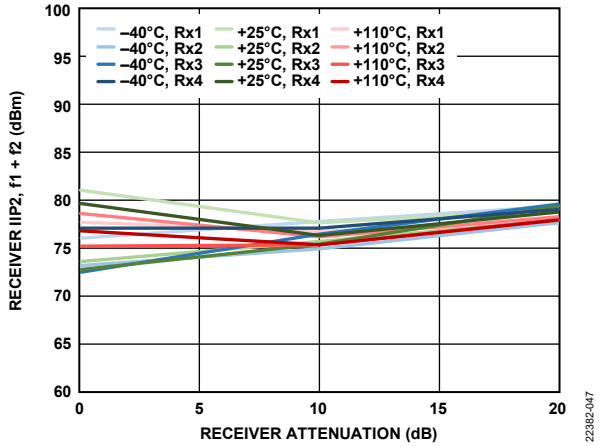

Figure 118. Receiver IIP2,  $f_1 + f_2$  vs. Receiver Attenuation, Both Tones at  $-11$  dBFS,  $f_1 = 92$  MHz,  $f_2 = 2$  MHz

22382-047

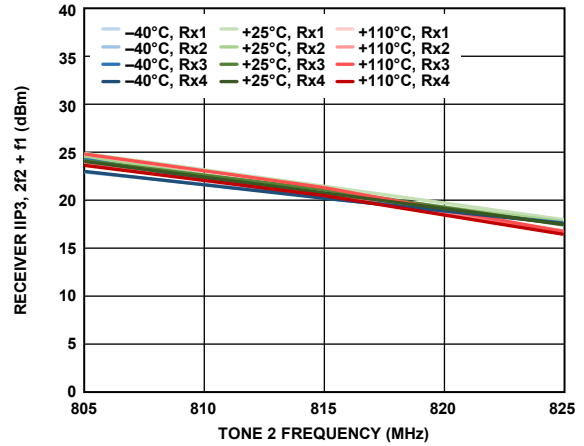

Figure 121. Receiver IIP3,  $2f_2 + f_1$  vs. Tone 2 Frequency, Both Tones at  $-11$  dBFS,  $f_1 = f_2 + 2$  MHz

22382-050

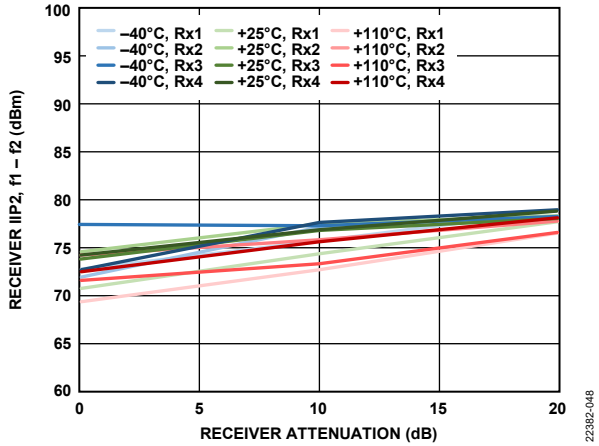

Figure 119. Receiver IIP2,  $f_1 - f_2$  vs. Receiver Attenuation, Both Tones at  $-11$  dBFS,  $f_1 = 92$  MHz,  $f_2 = 2$  MHz

22382-046

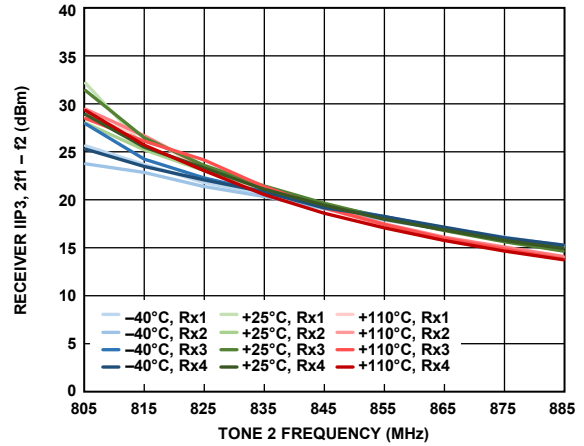

Figure 122. Receiver IIP3,  $2f_1 - f_2$  vs. Tone 2 Frequency, Both Tones at  $-11$  dBFS,  $f_1 = f_2 + 2$  MHz

22382-051

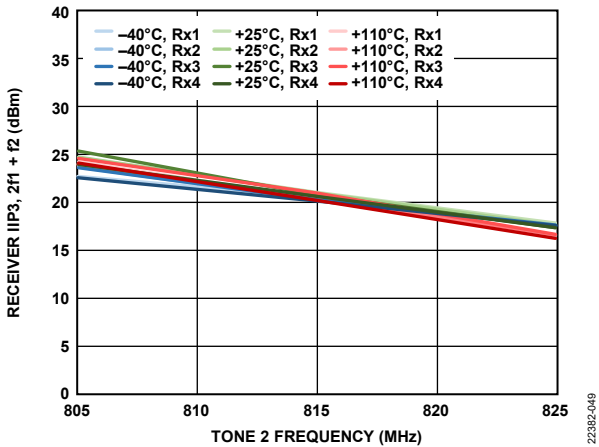

Figure 120. Receiver IIP3,  $2f_1 + f_2$  vs. Tone 2 Frequency, Both Tones at  $-11$  dBFS,  $f_1 = f_2 + 2$  MHz

22382-049

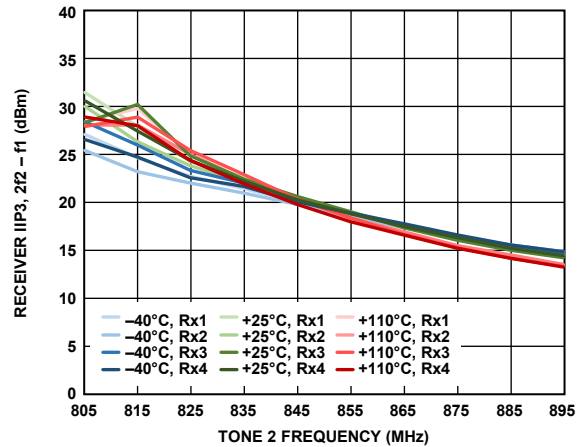

Figure 123. Receiver IIP3,  $2f_2 - f_1$  vs. Tone 2 Frequency, Both Tones at  $-11$  dBFS,  $f_1 = f_2 + 2$  MHz

22382-052

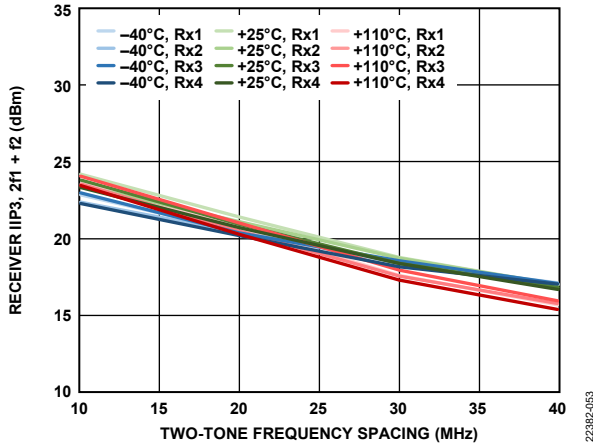

Figure 124. Receiver IIP3,  $2f_1 + f_2$  vs. Two-Tone Frequency Spacing, Both Tones at  $-11$  dBFS,  $f_2 = 2$  MHz

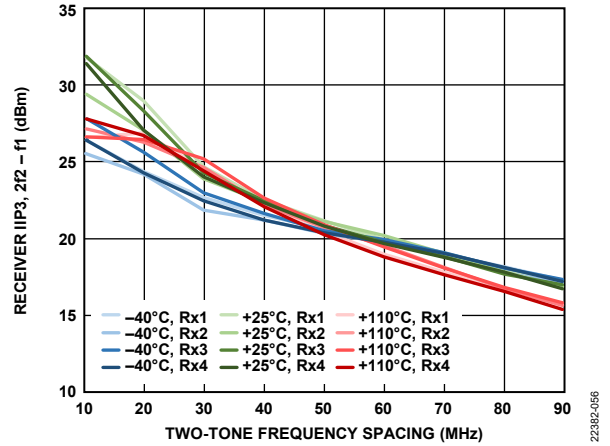

Figure 127. Receiver IIP3,  $2f_2 - f_1$  vs. Two-Tone Frequency Spacing, Both Tones at  $-11$  dBFS,  $f_2 = 2$  MHz

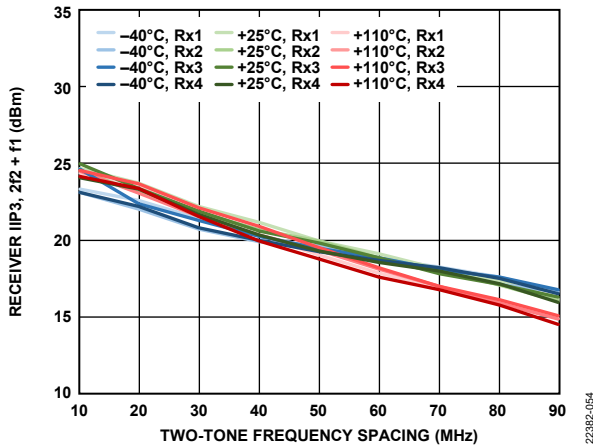

Figure 125. Receiver IIP3,  $2f_2 + f_1$  vs. Two-Tone Frequency Spacing, Both Tones at  $-11$  dBFS,  $f_2 = 2$  MHz

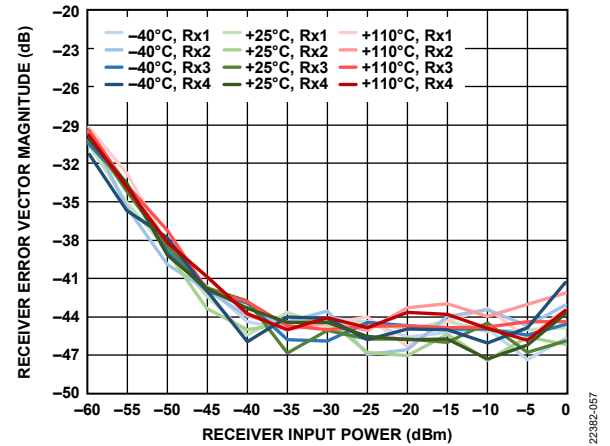

Figure 128. Receiver Error Vector Magnitude vs. Receiver Input Power, 20 MHz LTE Signal Centered at LO Frequency, Sample Rate = 245.76 MSPS, Loop Filter Bandwidth = 50 kHz, Loop Filter Phase Margin =  $85^\circ$

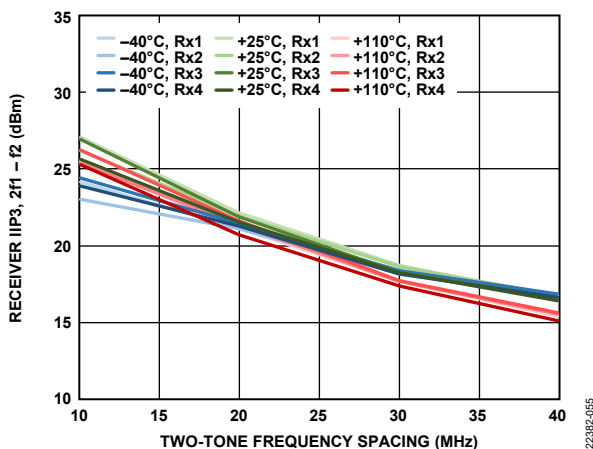

Figure 126. Receiver IIP3,  $2f_1 - f_2$  vs. Two-Tone Frequency Spacing, Both Tones at  $-11$  dBFS,  $f_2 = 2$  MHz

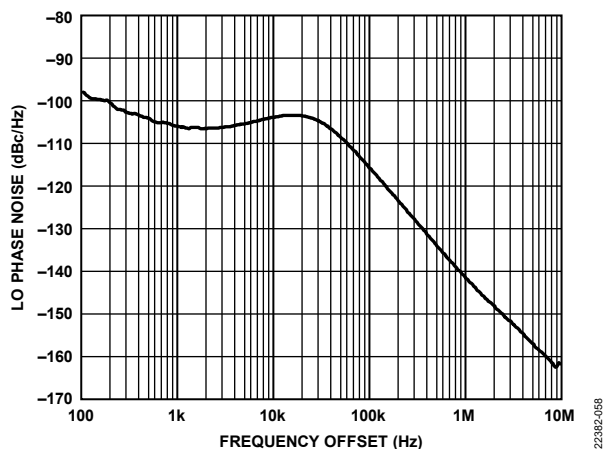

Figure 129. LO Phase Noise vs. Frequency Offset, Loop Bandwidth = 50 kHz, Phase Margin =  $85^\circ$

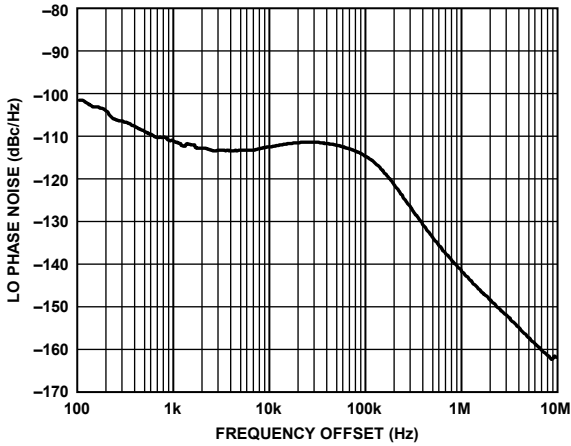

Figure 130. LO Phase Noise vs. Frequency Offset, Loop Bandwidth = 100 kHz, Phase Margin = 60°

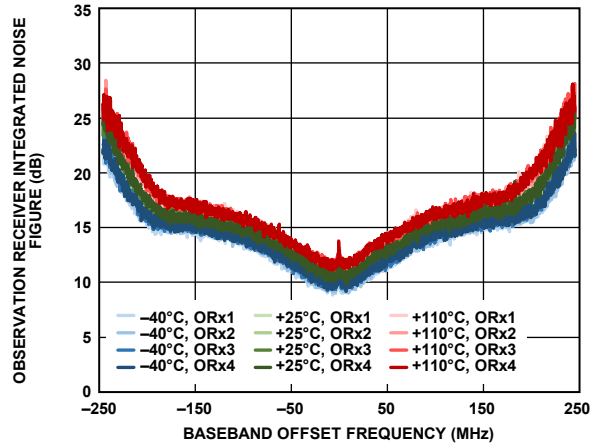

Figure 133. Observation Receiver Integrated Noise Figure vs. Baseband Offset Frequency, 450 MHz Bandwidth, Sample Rate = 491.52 MSPS, Integrated in 200 kHz Steps

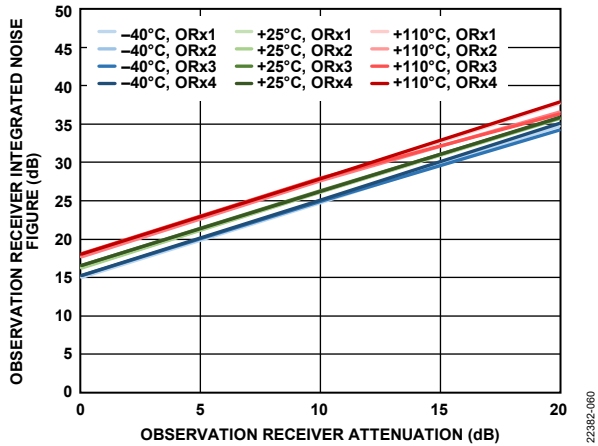

Figure 131. Observation Receiver (ORx) Integrated Noise Figure vs. Observation Receiver Attenuation, 450 MHz Bandwidth, Sample Rate = 491.52 MSPS, Integration Bandwidth = 500 kHz to 245.76 MHz

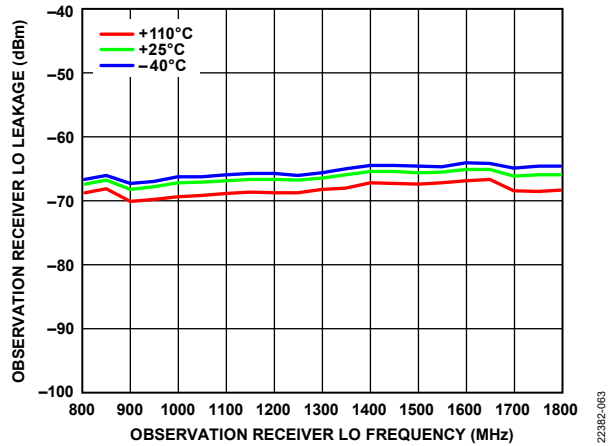

Figure 134. Observation Receiver LO Leakage vs. Observation Receiver LO Frequency, Attenuation = 0 dB, Sample Rate = 491.52 MSPS

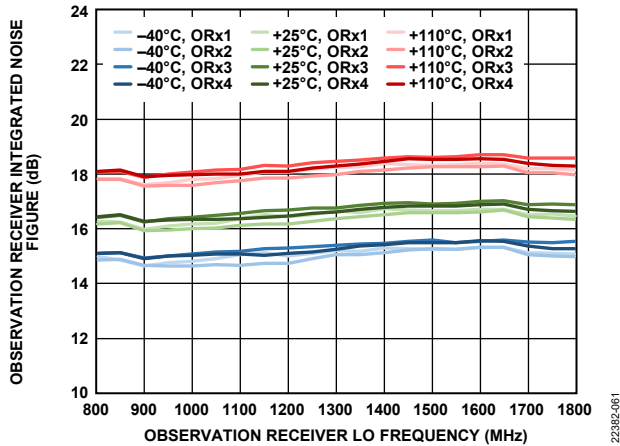

Figure 132. Observation Receiver Integrated Noise Figure vs. Observation Receiver LO Frequency, Attenuation = 0 dB, Sample Rate = 491.52 MSPS, Integration Bandwidth = 500 kHz to 245.76 MHz

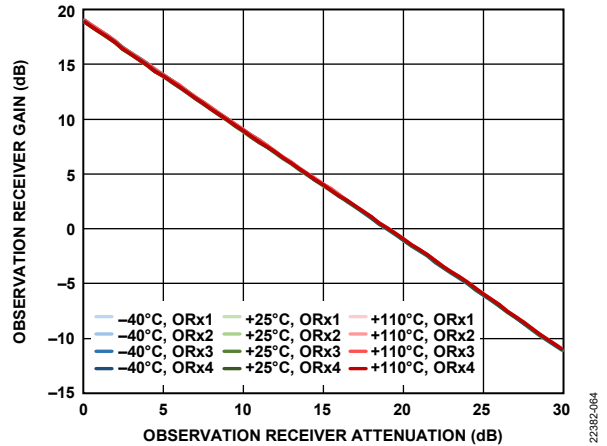

Figure 135. Observation Receiver Gain vs. Observation Receiver Attenuation, 45 MHz Offset, 450 MHz Bandwidth, Sample Rate = 491.52 MSPS

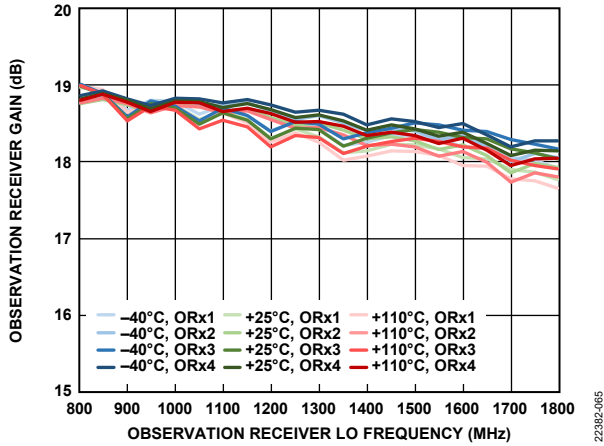

Figure 136. Observation Receiver Gain vs. Observation Receiver LO Frequency, 450 MHz Bandwidth, Sample Rate = 491.52 MSPS

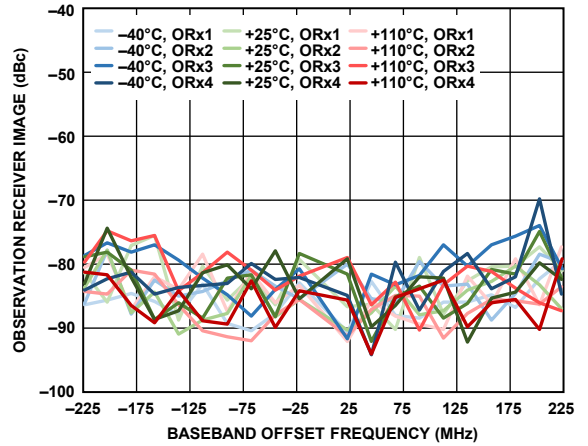

Figure 139. Observation Receiver Image vs. Baseband Offset Frequency, Tracking Calibration Active, Sample Rate = 491.52 MSPS

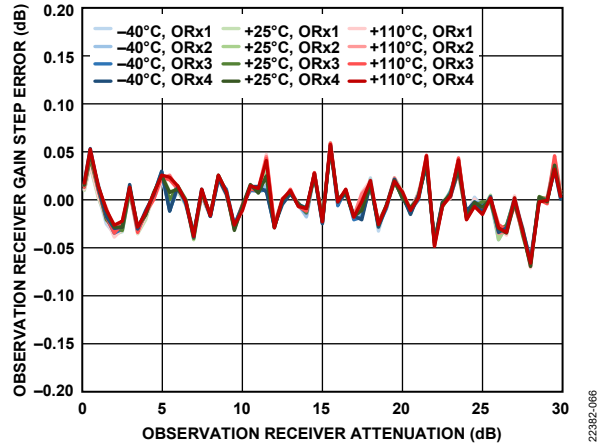

Figure 137. Observation Receiver Gain Step Error vs. Observation Receiver Attenuation, 45 MHz Offset, -10 dBFS Input Signal

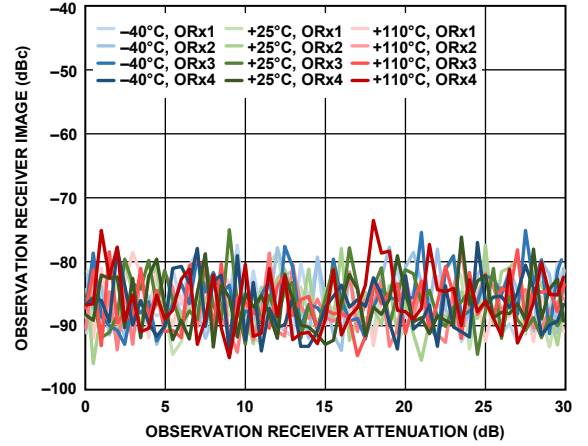

Figure 140. Observation Receiver Image vs. Observation Receiver Attenuation, 45 MHz Offset, Tracking Calibration Active, Sample Rate = 491.52 MSPS

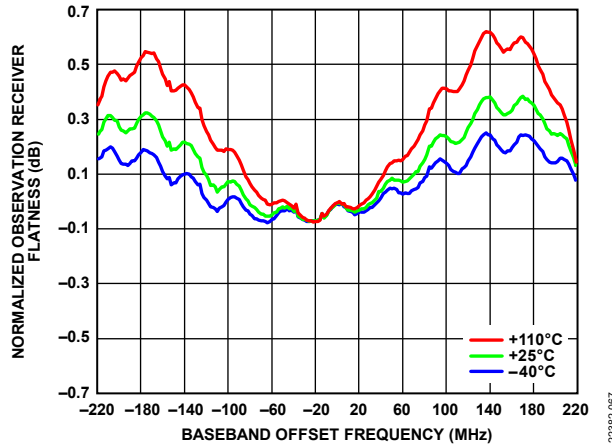

Figure 138. Normalized Observation Receiver Flatness vs. Baseband Offset Frequency, -10 dBFS Input Signal

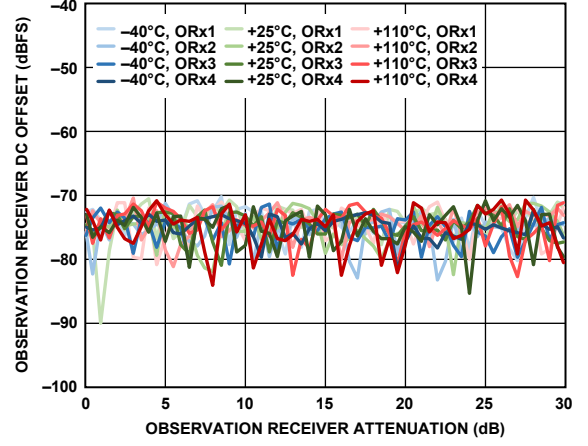
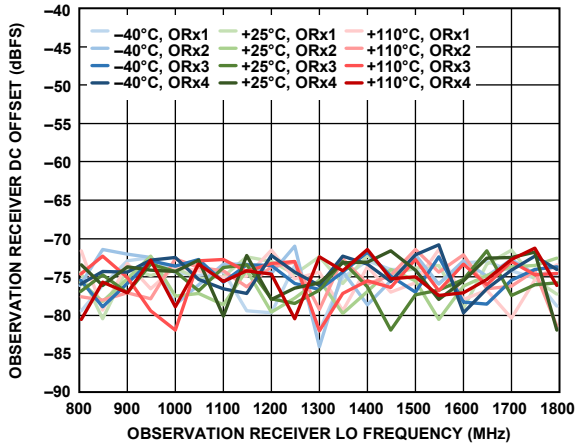
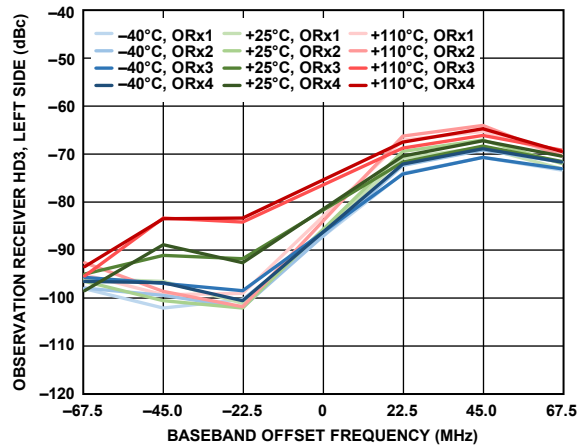

Figure 141. Observation Receiver DC Offset vs. Observation Receiver Attenuation, 45 MHz Offset, -10 dBFS Input Signal



22382-071

Figure 142. Observation Receiver DC Offset vs. Observation Receiver LO Frequency, Attenuation = 0 dB, Sample Rate = 491.52 MSPS



22382-074

Figure 145. Observation Receiver HD3, Left Side vs. Baseband Offset Frequency, -10 dBFS Input Signal, Distortion Tone Measured Left of 0 Hz

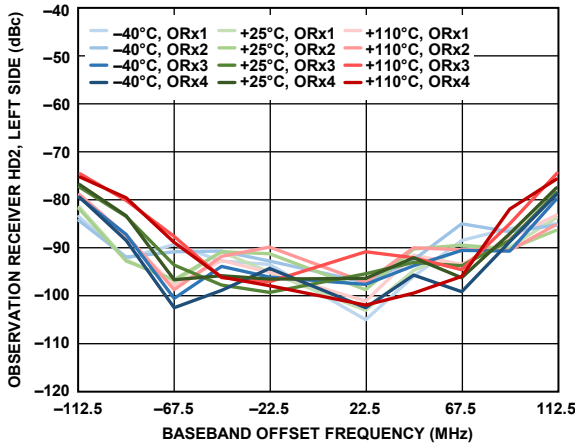

22382-072

Figure 143. Observation Receiver HD2, Left Side vs. Baseband Offset Frequency, -10 dBFS Input Signal, Distortion Tone Measured Left of 0 Hz

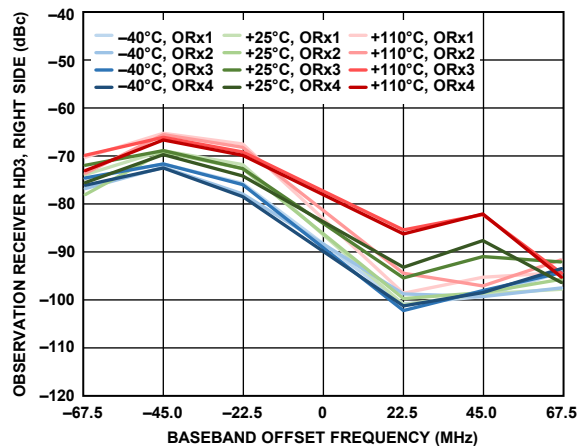

22382-075

Figure 146. Observation Receiver HD3, Right Side vs. Baseband Offset Frequency, -10 dBFS Input Signal, Distortion Tone Measured Right of 0 Hz

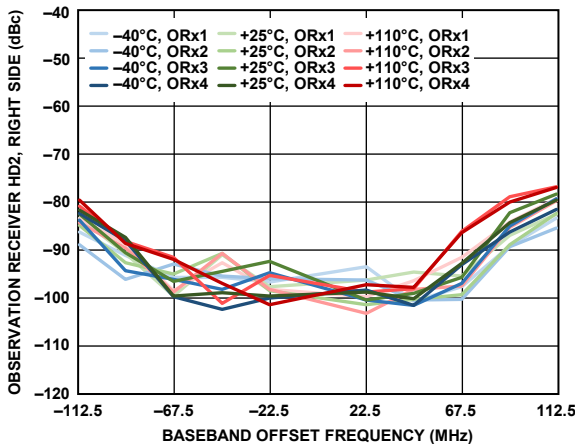

22382-073

Figure 144. Observation Receiver HD2, Right Side vs. Baseband Offset Frequency, -10 dBFS Input Signal, Distortion Tone Measured Right of 0 Hz

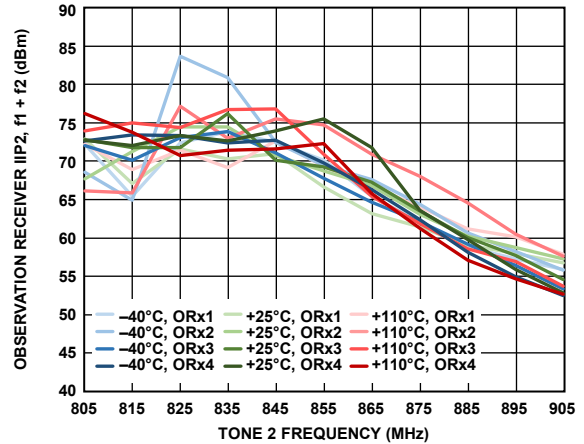

22382-076

Figure 147. Observation Receiver IIP2, f1 + f2 vs. Tone 2 Frequency, Both Tones at -13 dBFS, f1 = f2 + 2 MHz



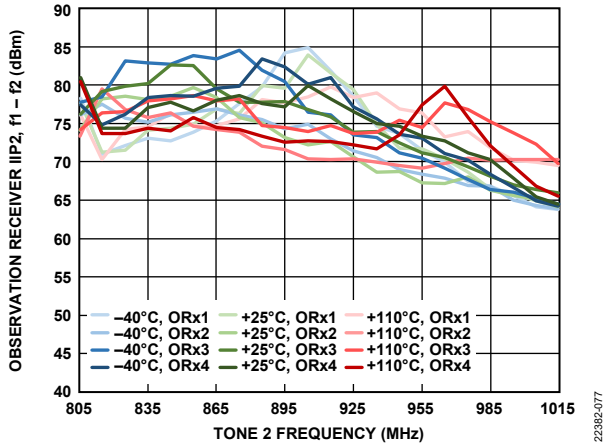

Figure 148. Observation Receiver IIP2,  $f_1 - f_2$  vs. Tone 2 Frequency, Both Tones at  $-13$  dBFS,  $f_1 = f_2 + 2$  MHz

22382-077

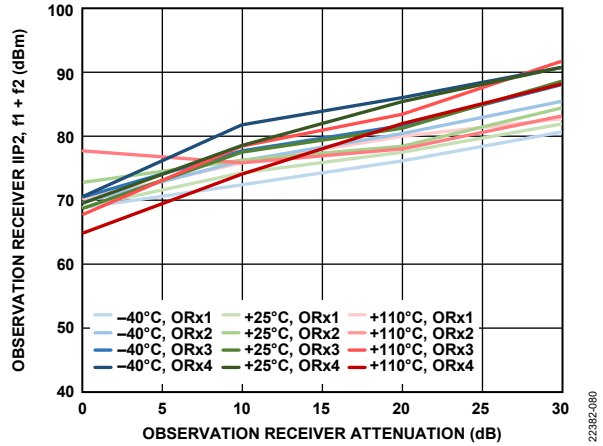

Figure 151. Observation Receiver IIP2,  $f_1 + f_2$  vs. Observation Receiver Attenuation, Both Tones at  $-13$  dBFS,  $f_1 = 102$  MHz,  $f_2 = 2$  MHz

22382-080

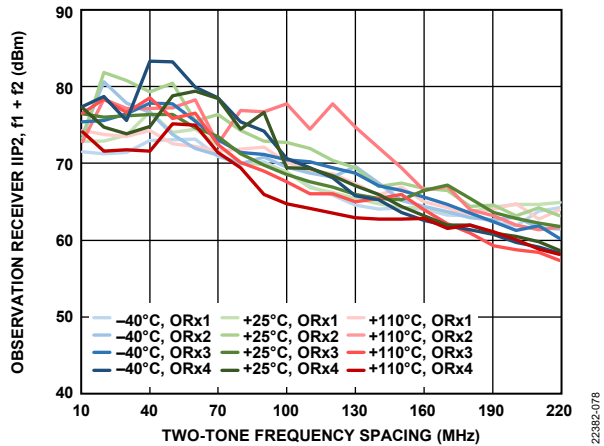

Figure 149. Observation Receiver IIP2,  $f_1 + f_2$  vs. Two-Tone Frequency Spacing, Both Tones at  $-13$  dBFS,  $f_2 = 2$  MHz

22382-078

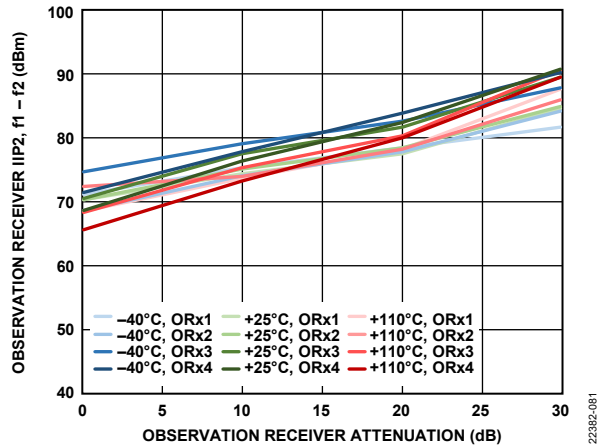

Figure 152. Observation Receiver IIP2,  $f_1 - f_2$  vs. Observation Receiver Attenuation, Both Tones at  $-13$  dBFS,  $f_1 = 102$  MHz,  $f_2 = 2$  MHz

22382-081

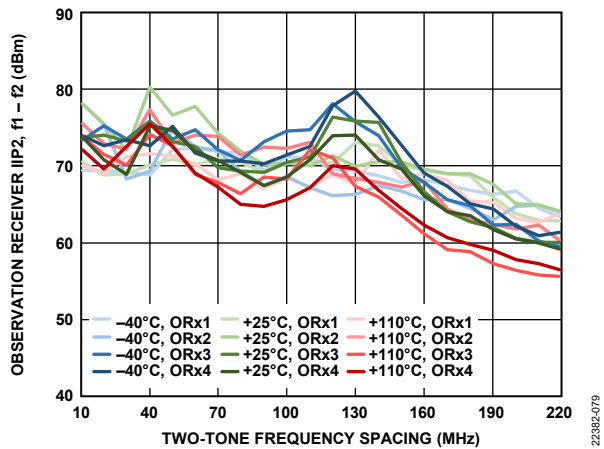

Figure 150. Observation Receiver IIP2,  $f_1 - f_2$  vs. Two-Tone Frequency Spacing, Both Tones at  $-13$  dBFS,  $f_2 = 2$  MHz

22382-079

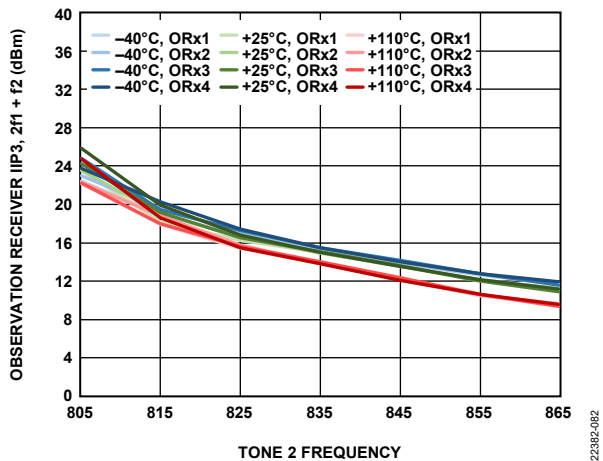
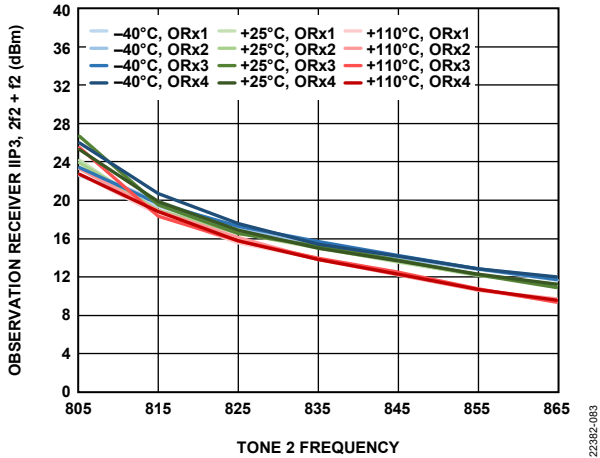

Figure 153. Observation Receiver IIP3,  $2f_1 + f_2$  vs. Tone 2 Frequency, Both Tones at  $-13$  dBFS,  $f_1 = f_2 + 2$  MHz

22382-082



22382-083

Figure 154. Observation Receiver IIP3,  $2f_2 + f_2$  vs. Tone 2 Frequency, Both Tones at  $-13$  dBFS,  $f_1 = f_2 + 2$  MHz

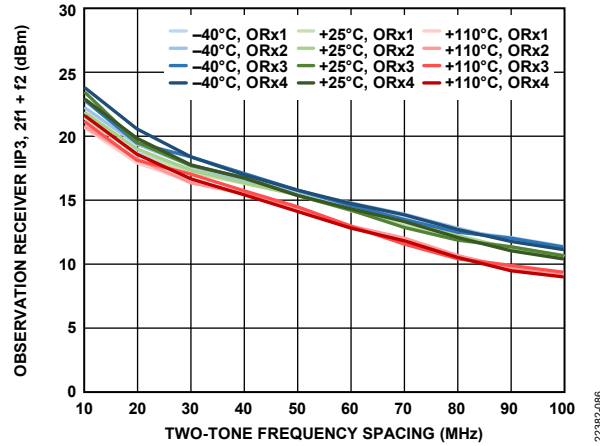

22382-086

Figure 157. Observation Receiver IIP3,  $2f_1 + f_2$  vs. Two-Tone Frequency Spacing, Both Tones at  $-13$  dBFS,  $f_2 = 2$  MHz

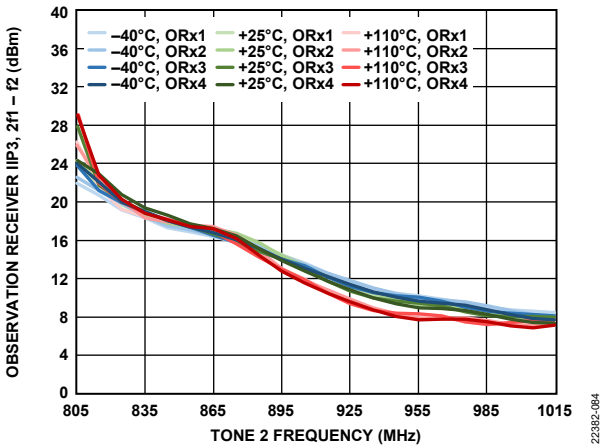

22382-084

Figure 155. Observation Receiver IIP3,  $2f_1 - f_2$  vs. Tone 2 Frequency, Both Tones at  $-13$  dBFS,  $f_1 = f_2 + 2$  MHz

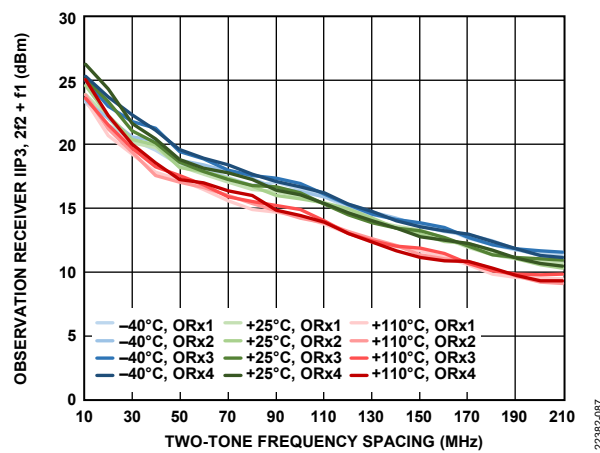

22382-087

Figure 158. Observation Receiver IIP3,  $2f_2 + f_1$  vs. Two-Tone Frequency Spacing, Both Tones at  $-13$  dBFS,  $f_2 = 2$  MHz

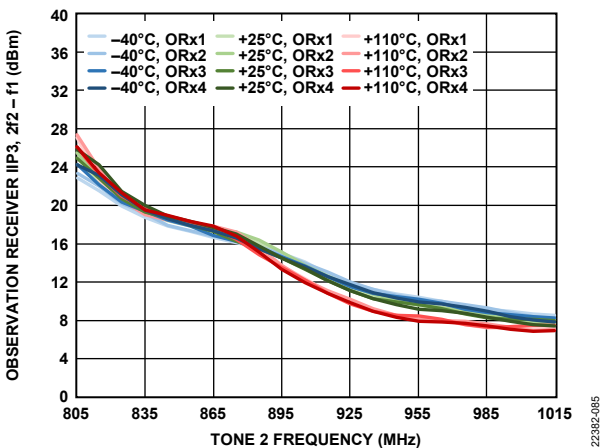

22382-085

Figure 156. Observation Receiver IIP3,  $2f_2 - f_1$  vs. Tone 2 Frequency, Both Tones at  $-13$  dBFS,  $f_1 = f_2 + 2$  MHz

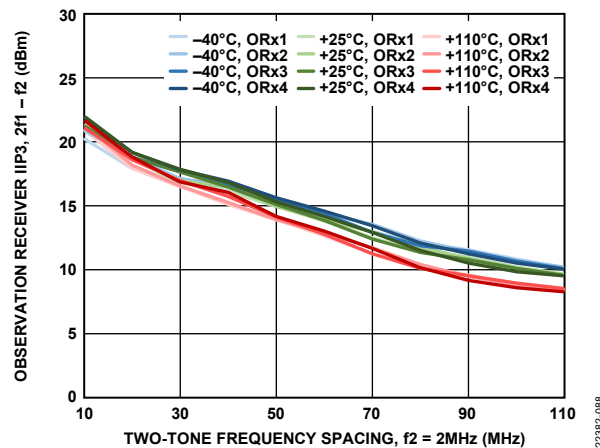

22382-088

Figure 159. Observation Receiver IIP3,  $2f_1 - f_2$  vs. Two-Tone Frequency Spacing, Both Tones at  $-13$  dBFS,  $f_2 = 2$  MHz

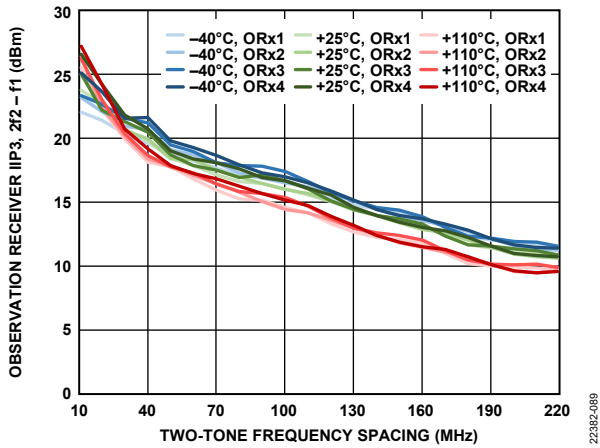

Figure 160. Observation Receiver IIP3, 2f2 - f1 vs. Two-Tone Frequency Spacing, Both Tones at -13 dBFS, f2 = 2 MHz

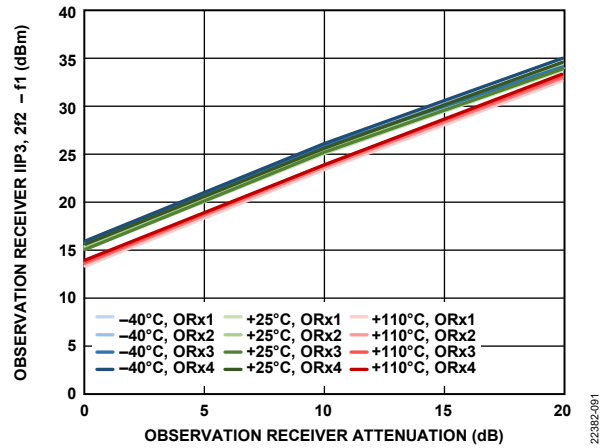

Figure 162. Observation Receiver IIP3, 2f2 - f1 vs. Observation Receiver Attenuation, Both Tones at -13 dBFS, f1 = 122 MHz, f2 = 2 MHz

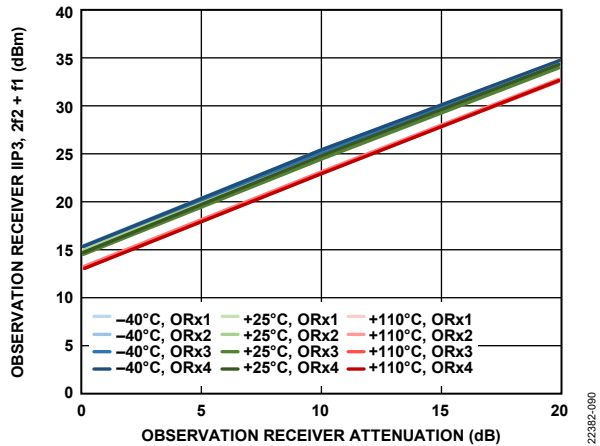

Figure 161. Observation Receiver IIP3, 2f2 + f1 vs. Observation Receiver Attenuation, Both Tones at -13 dBFS, f1 = 122 MHz, f2 = 2 MHz

**1800 MHz BAND**

Device configuration profile: receiver = 200 MHz bandwidth, I/Q rate = 245.76 MHz, transmitter = 200 MHz large signal bandwidth plus 450 MHz synthesis bandwidth, I/Q rate = 491.52 MHz, observation receiver (OR<sub>x</sub>) = 450 MHz bandwidth, I/Q rate = 491.52 MHz, device clock = 245.76 MHz, unless otherwise noted. The temperature settings refer to the die temperature. All LO frequencies set to 1800 MHz, unless otherwise noted.

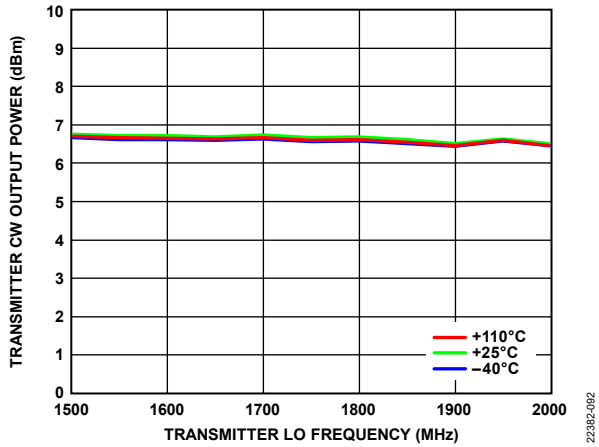

Figure 163. Transmitter Continuous Wave (CW) Output Power vs. Transmitter LO Frequency, 10 MHz Offset, 0 dB Attenuation

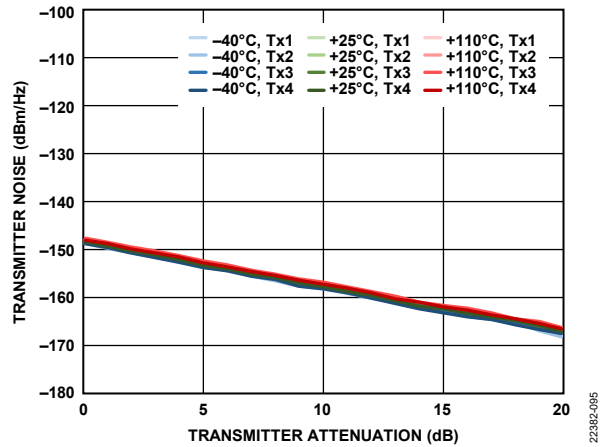

Figure 166. Transmitter Noise vs. Transmitter Attenuation, 10 MHz Offset

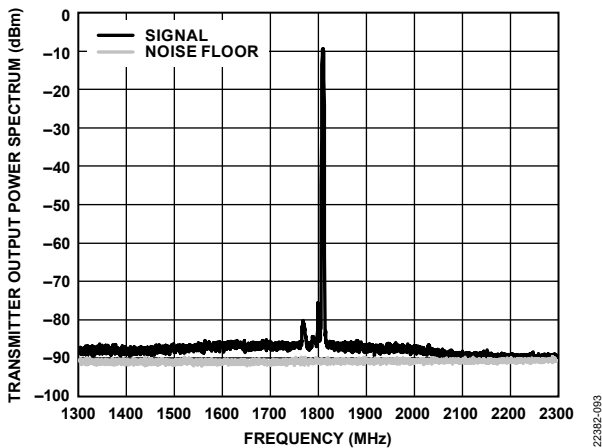

Figure 164. Transmitter Output Power Spectrum, TX1, 5 MHz LTE, 10 MHz Offset, -10 dBFS RMS, 1 MHz Resolution Bandwidth, T<sub>j</sub> = 25°C

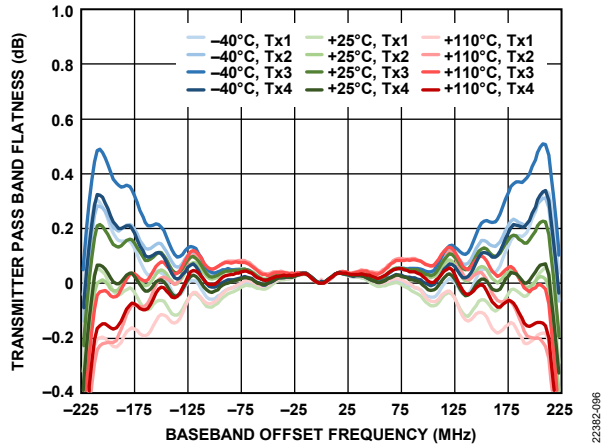

Figure 167. Transmitter Pass Band Flatness vs. Baseband Offset Frequency

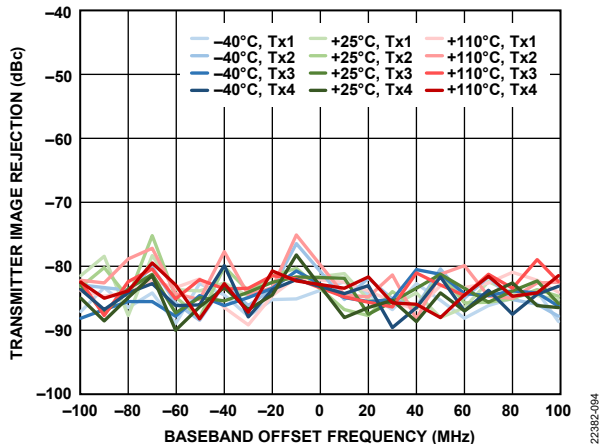

Figure 165. Transmitter Image Rejection Across Large Signal Bandwidth vs. Baseband Offset Frequency

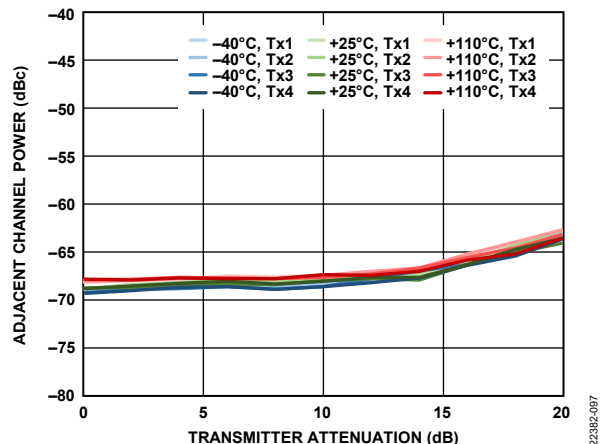

Figure 168. Adjacent Channel Power Level vs. Transmitter Attenuation, -10 MHz Baseband Offset, 20 MHz LTE, PAR = 12 dB

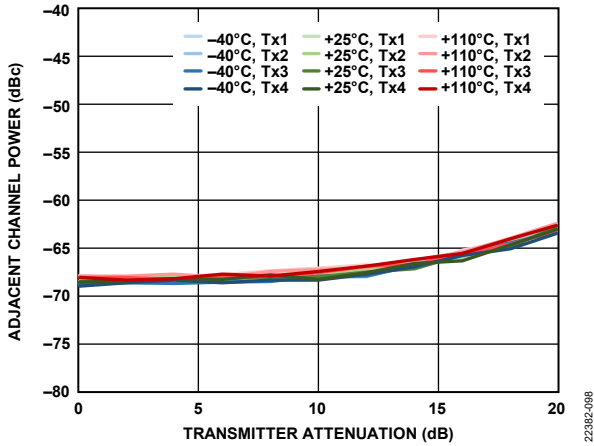

Figure 169. Adjacent Channel Power Level vs. Transmitter Attenuation, 90 MHz Baseband Offset, 20 MHz LTE, PAR = 12 dB

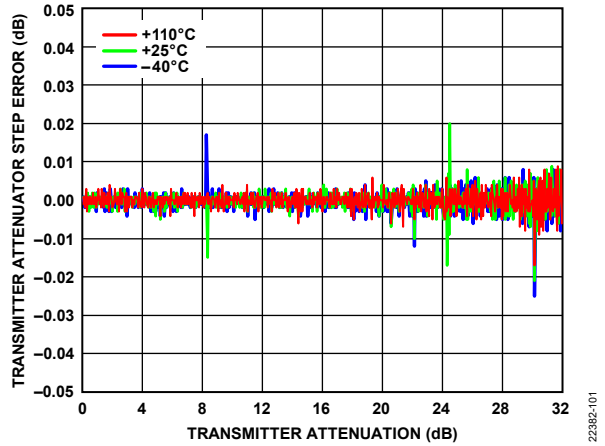

Figure 172. Transmitter Attenuator Step Error vs. Transmitter Attenuation, 10 MHz Offset

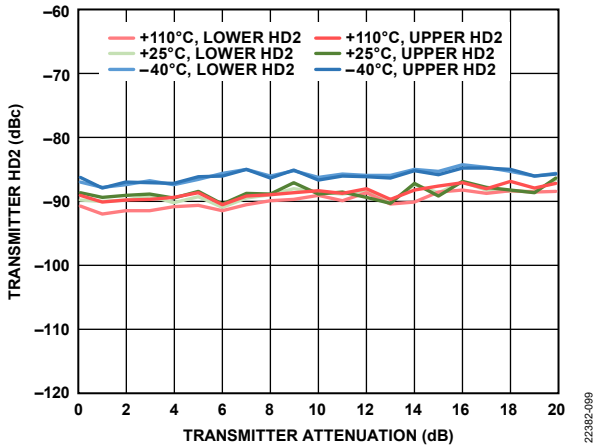

Figure 170. Transmitter Second Harmonic Distortion (HD2) vs. Transmitter Attenuation, 10 MHz Offset

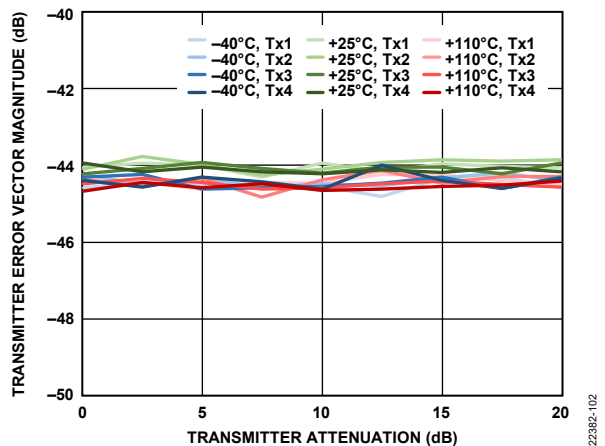

Figure 173. Transmitter Error Vector Magnitude vs. Transmitter Attenuation, 20 MHz LTE Signal Centered at LO Frequency, Sample Rate = 491.52 MSPS, Loop Filter Bandwidth = 500 kHz, Loop Filter Phase Margin = 60°

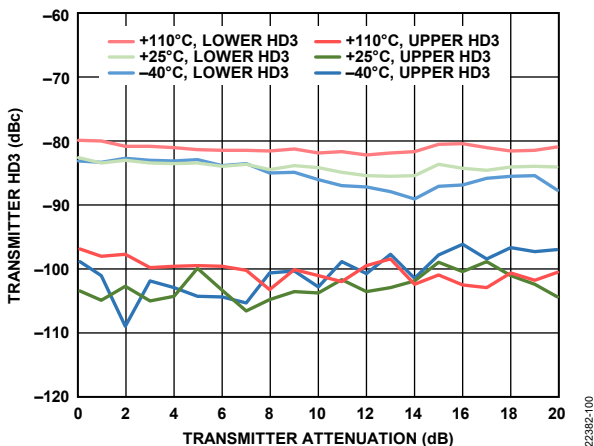

Figure 171. Transmitter Third Harmonic Distortion (HD3) vs. Transmitter Attenuation, 10 MHz Offset

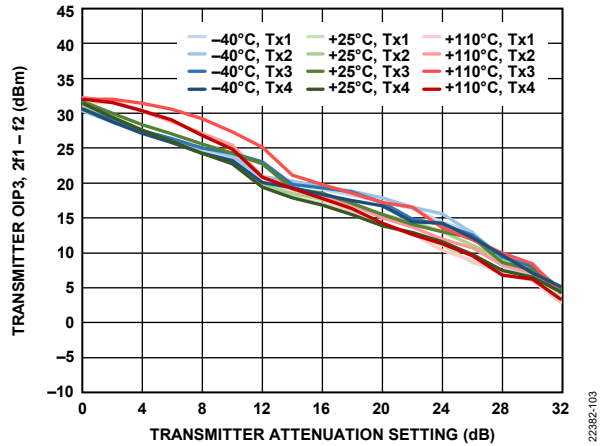

Figure 174. Transmitter OIP3, 2f1 - f2 vs. Transmitter Attenuation, 15 dB Digital Back Off per Tone, f1 = 50.5 MHz, f2 = 55.5 MHz

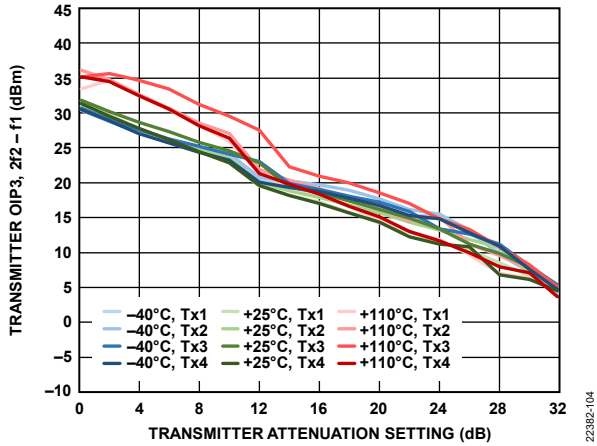

Figure 175. Transmitter OIP3, 2f2 - f1 vs. Transmitter Attenuation, 15 dB Digital Back Off per Tone, f1 = 50.5 MHz, f2 = 55.5 MHz

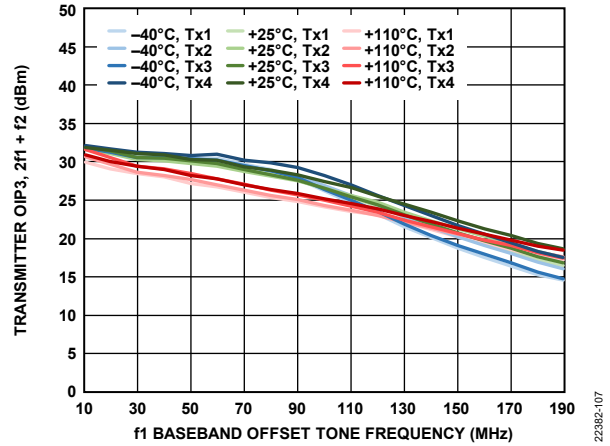

Figure 178. Transmitter OIP3, 2f1 + f2 vs. f1 Baseband Offset Tone Frequency, f2 = f1 + 5 MHz, 15 dB Digital Back Off per Tone

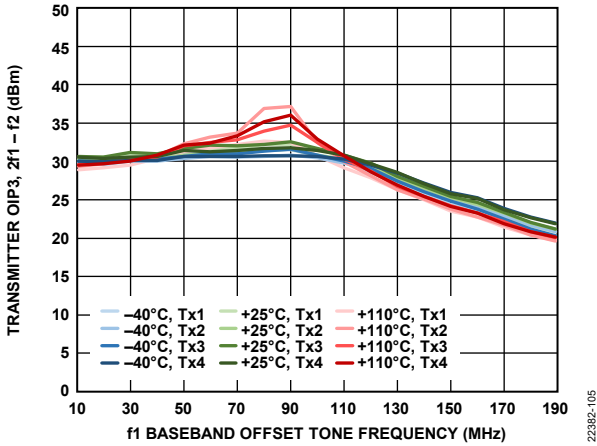

Figure 176. Transmitter OIP3, 2f1 - f2 vs. f1 Baseband Offset Tone Frequency, f2 = f1 + 5 MHz, 15 dB Digital Back Off per Tone

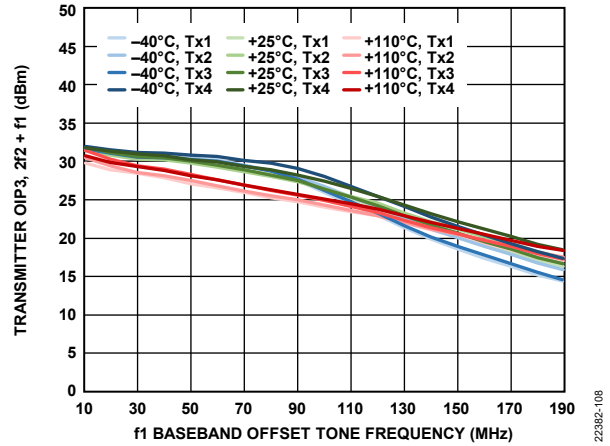

Figure 179. Transmitter OIP3, 2f2 + f1 vs. f1 Baseband Offset Tone Frequency, f2 = f1 + 5 MHz, 15 dB Digital Back Off per Tone

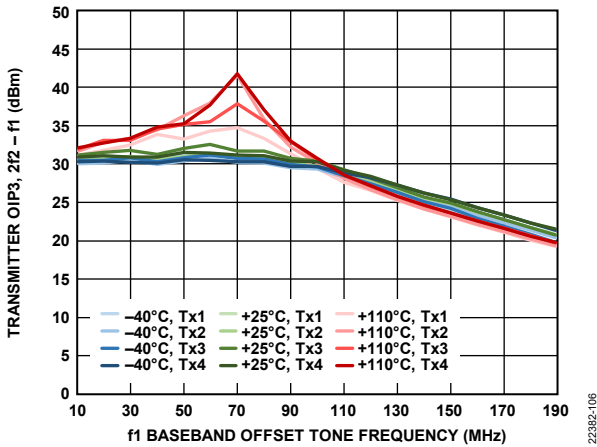

Figure 177. Transmitter OIP3, 2f2 - f1 vs. f1 Baseband Offset Tone Frequency, f2 = f1 + 5 MHz, 15 dB Digital Back Off per Tone

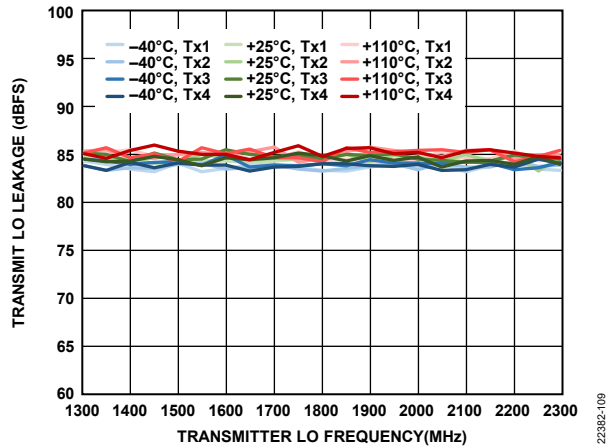

Figure 180. Transmitter LO Leakage vs. Transmitter LO Frequency

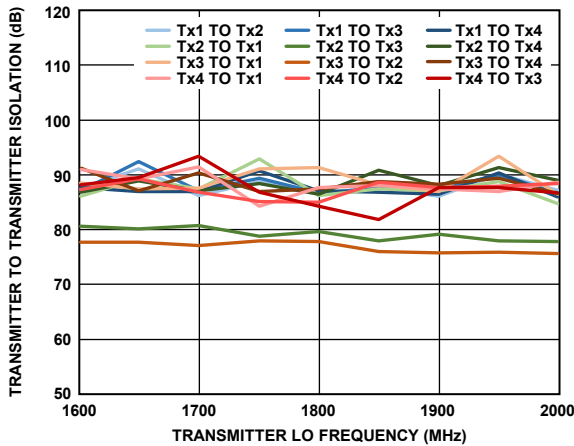

Figure 181. Transmitter to Transmitter Isolation vs. Transmitter LO Frequency

22382-110

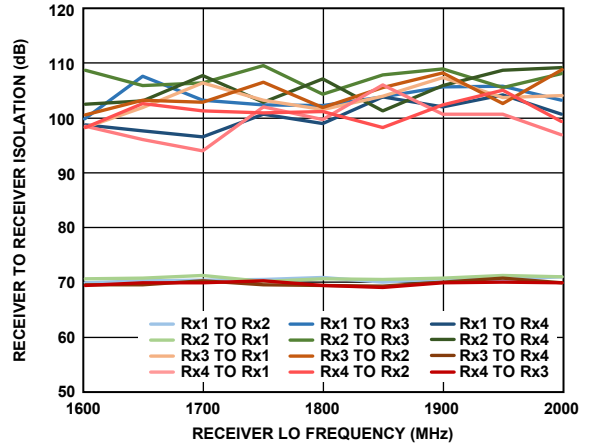

Figure 184. Receiver to Receiver Isolation vs. Receiver LO Frequency

22382-113

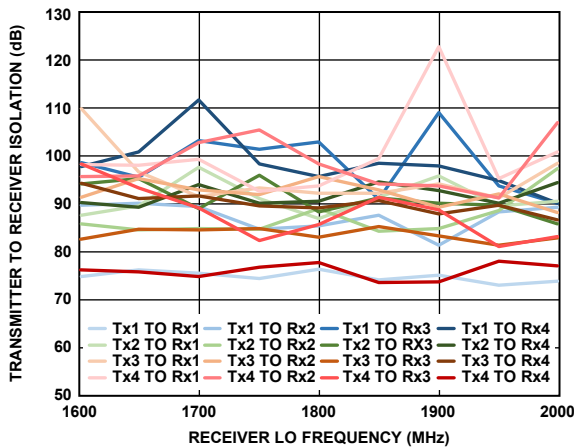

Figure 182. Transmitter to Receiver Isolation vs. Receiver LO Frequency

22382-111

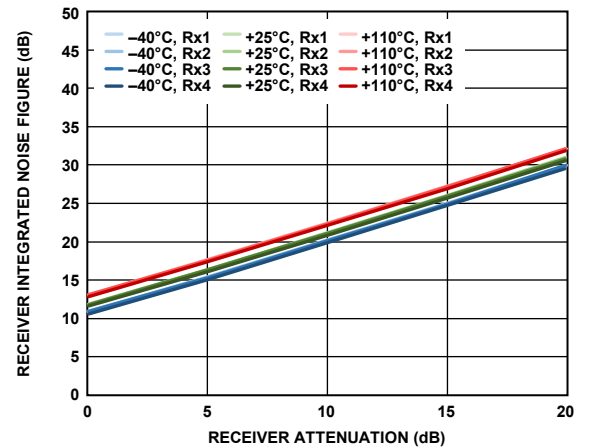

Figure 185. Receiver Integrated Noise Figure vs. Receiver Attenuation, 200 MHz Bandwidth, Sample Rate = 245.76 MSPS, Integration Bandwidth = 500 kHz to 100 MHz

22382-114

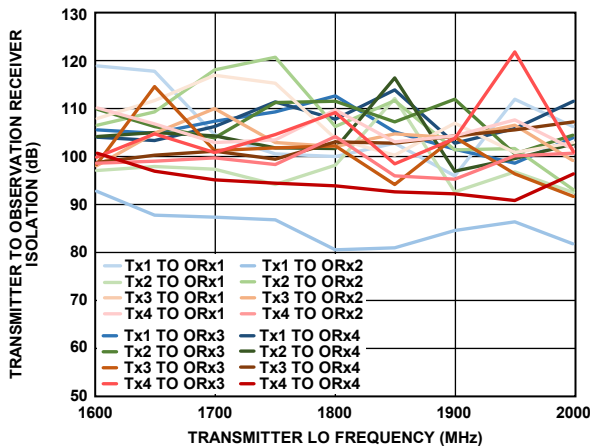

Figure 183. Transmitter to Observation Receiver Isolation vs. Transmitter LO Frequency

22382-112

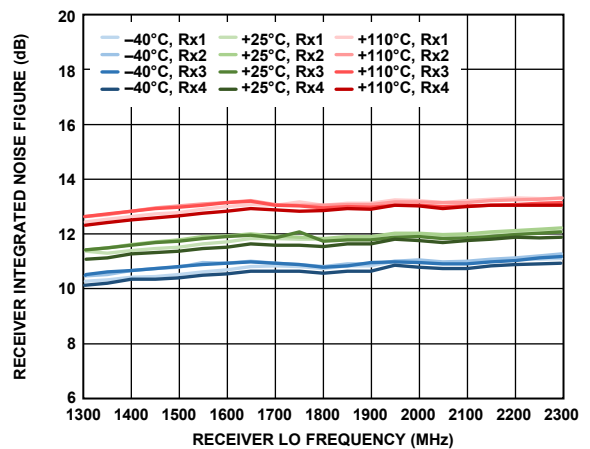

Figure 186. Receiver Integrated Noise Figure vs. Receiver LO Frequency, 200 MHz Bandwidth, Sample Rate = 245.76 MSPS, Integration Bandwidth = 500 kHz to 100 MHz

22382-115

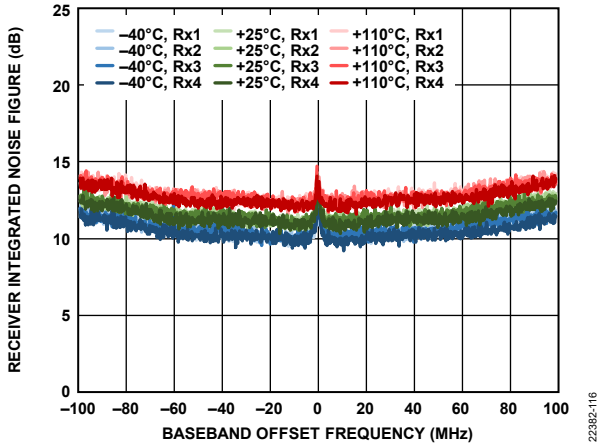

Figure 187. Receiver Integrated Noise Figure vs. Baseband Offset Frequency, 200 MHz Bandwidth, Sample Rate = 245.76 MSPS, Integrated in 200 kHz Steps

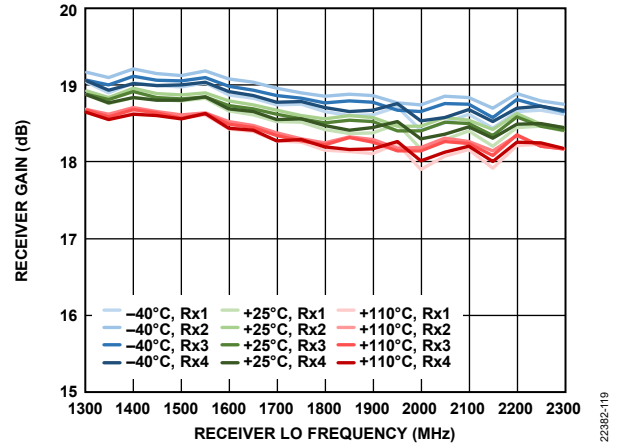

Figure 190. Receiver Gain vs. Receiver LO Frequency, 200 MHz Bandwidth, Sample Rate = 245.76 MSPS

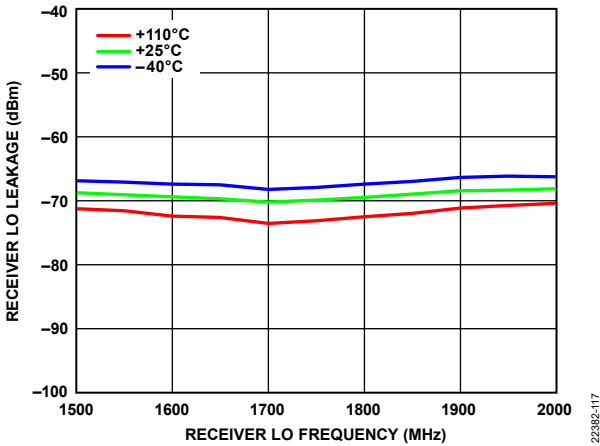

Figure 188. Receiver LO Leakage vs. Receiver LO Frequency, Attenuation = 0 dB, Sample Rate = 245.76 MSPS

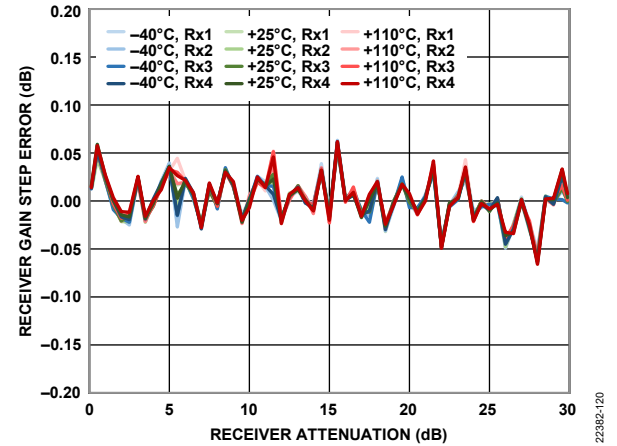

Figure 191. Receiver Gain Step Error vs. Receiver Attenuation, 20 MHz Offset, -5 dBFS Input Signal

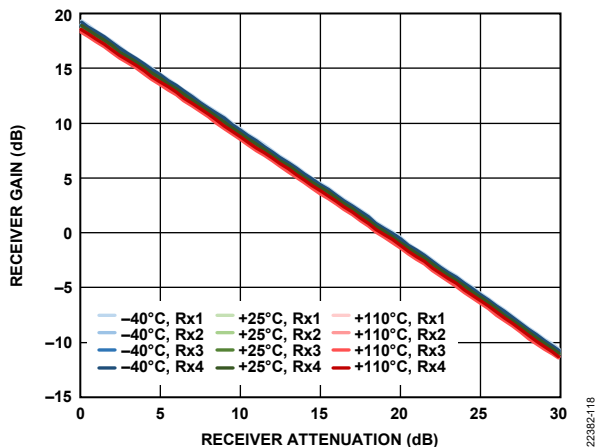

Figure 189. Receiver Gain vs. Receiver Attenuation, 20 MHz Offset, 200 MHz Bandwidth, Sample Rate = 245.76 MSPS

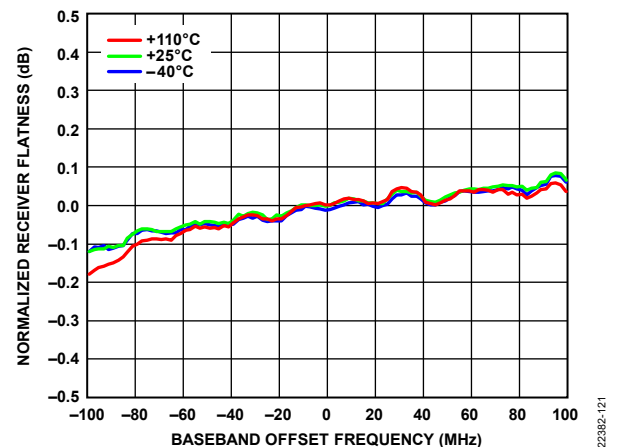

Figure 192. Normalized Receiver Flatness vs. Baseband Offset Frequency, -5 dBFS Input Signal



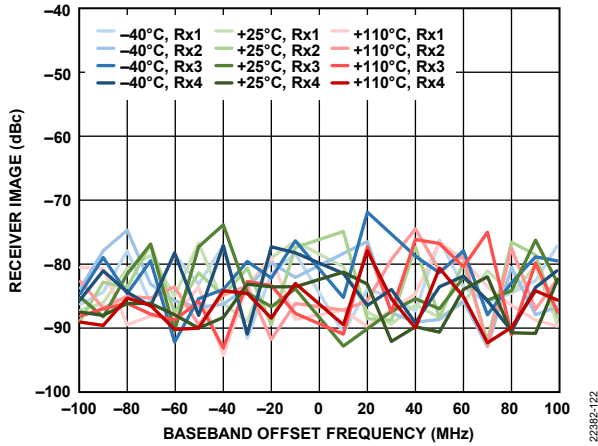

Figure 193. Receiver Image vs. Baseband Offset Frequency, Tracking Calibration Active, Sample Rate = 245.76 MSPS

22382-122

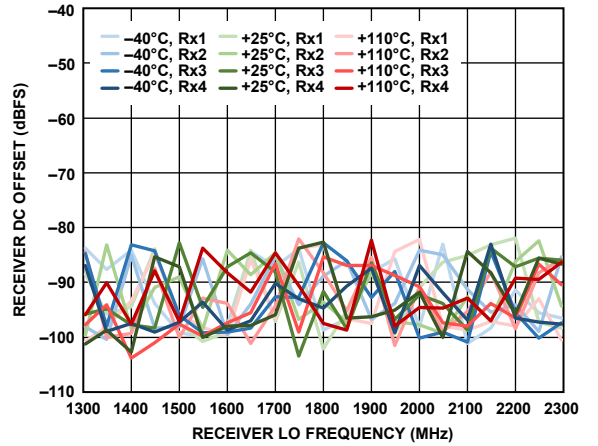

Figure 196. Receiver DC Offset vs. Receiver LO Frequency, 20 MHz Offset, -5 dBFS Input Signal

22382-125

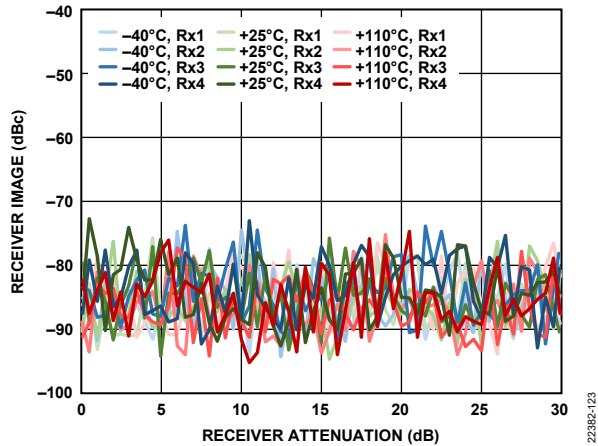

Figure 194. Receiver Image vs. Receiver Attenuation, 20 MHz Offset, Tracking Calibration Active, Sample Rate = 245.76 MSPS

22382-123

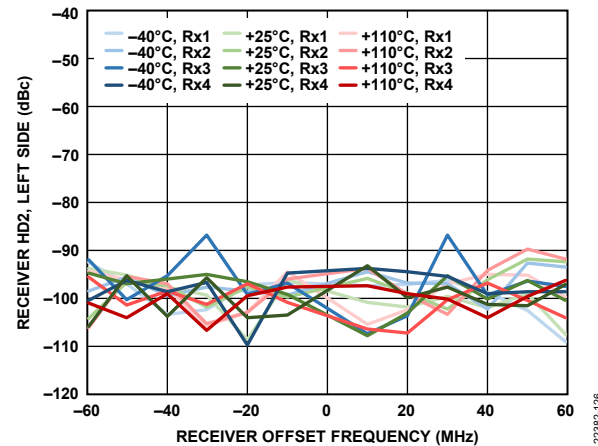

Figure 197. Receiver HD2, Left Side vs. Baseband Offset Frequency, -5 dBFS Input Signal, Distortion Tone Measured Left of 0 Hz (HD2 Canceller Not Enabled)

22382-126

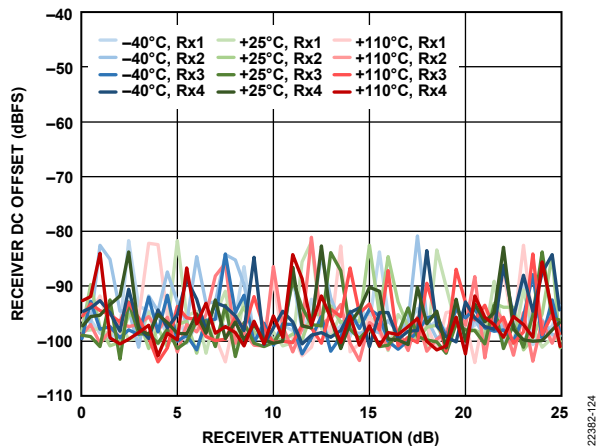

Figure 195. Receiver DC Offset vs. Receiver Attenuation, 20 MHz Offset, -5 dBFS Input Signal

22382-124

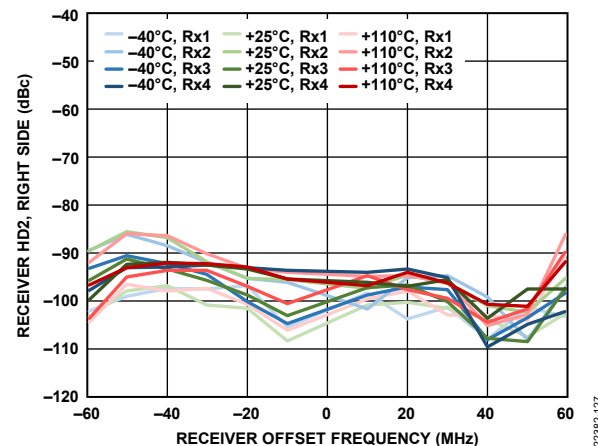

Figure 198. Receiver HD2, Right Side vs. Baseband Offset Frequency, -5 dBFS Input Signal, Distortion Tone Measured Right of 0 Hz (HD2 Canceller Not Enabled)

22382-127

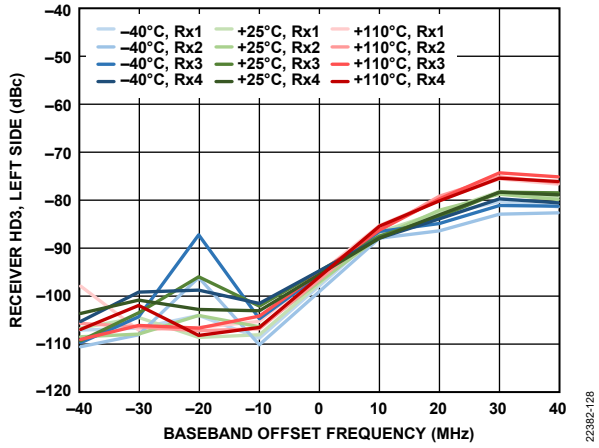

Figure 199. Receiver HD3, Left Side vs. Baseband Offset Frequency, -5 dBFS Input Signal, Distortion Tone Measured Left of 0 Hz

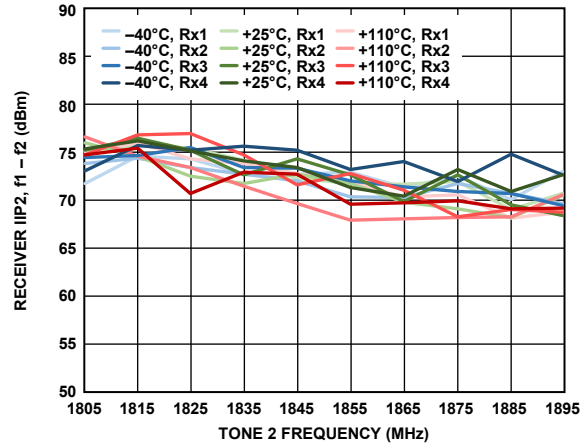

Figure 202. Receiver IIP2,  $f_1 - f_2$  vs. Tone 2 Frequency, Both Tones at -11 dBFS,  $f_1 = f_2 + 2$  MHz

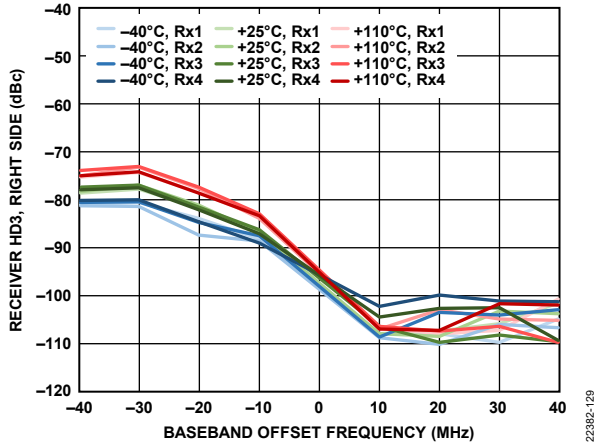

Figure 200. Receiver HD3, Right Side vs. Baseband Offset Frequency, -5 dBFS Input Signal, Distortion Tone Measured Right of 0 Hz

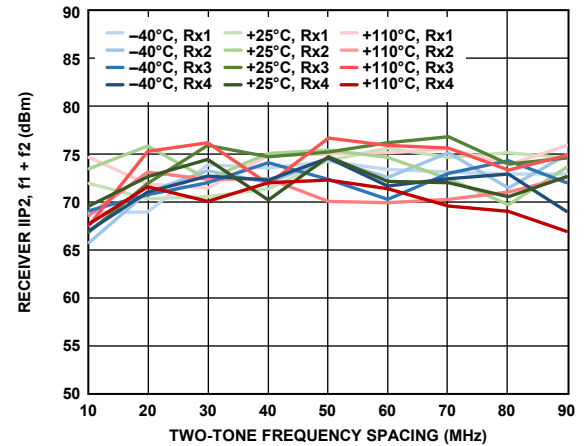

Figure 203. Receiver IIP2,  $f_1 + f_2$  vs. Two-Tone Frequency Spacing, Both Tones at -11 dBFS,  $f_2 = 2$  MHz

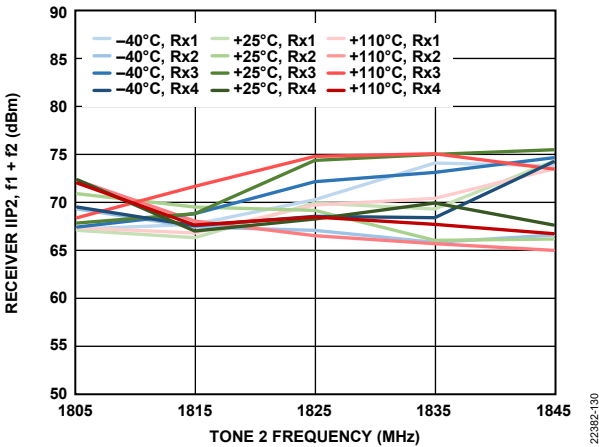

Figure 201. Receiver IIP2,  $f_1 + f_2$  vs. Tone 2 Frequency, Both Tones at -11 dBFS,  $f_1 = f_2 + 2$  MHz

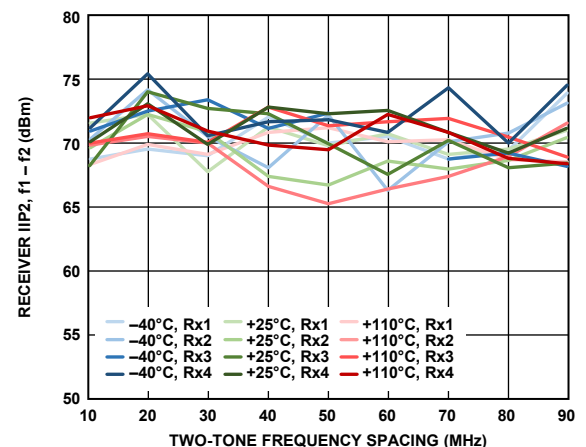

Figure 204. Receiver IIP2,  $f_1 - f_2$  vs. Two-Tone Frequency Spacing, Both Tones at -11 dBFS,  $f_2 = 2$  MHz

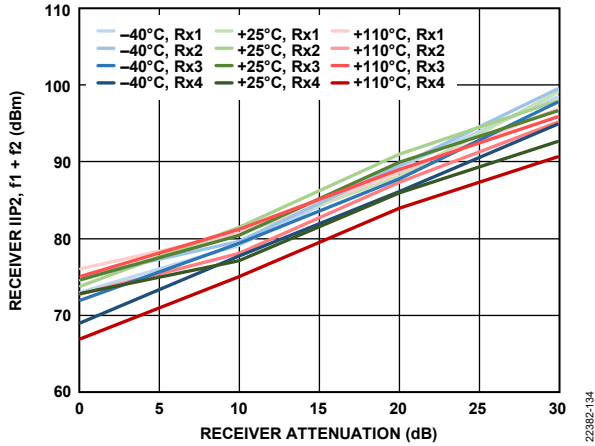

Figure 205. Receiver IIP2,  $f_1 + f_2$  vs. Receiver Attenuation, Both Tones at  $-11$  dBFS,  $f_1 = 92$  MHz,  $f_2 = 2$  MHz

22382-134

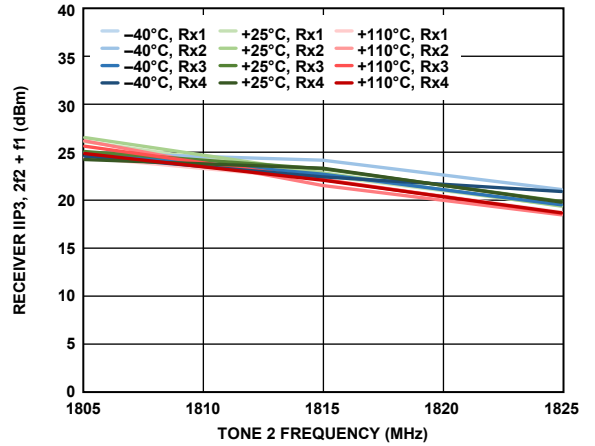

Figure 208. Receiver IIP3,  $2f_2 + f_1$  vs. Tone 2 Frequency, Both Tones at  $-11$  dBFS,  $f_1 = f_2 + 2$  MHz

22382-137

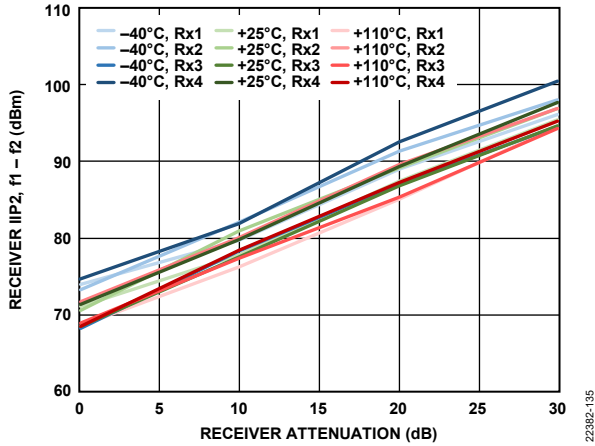

Figure 206. Receiver IIP2,  $f_1 - f_2$  vs. Receiver Attenuation, Both Tones at  $-11$  dBFS,  $f_1 = 92$  MHz,  $f_2 = 2$  MHz

22382-135

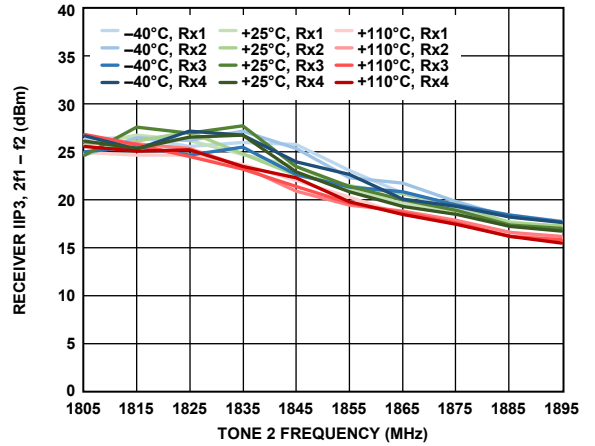

Figure 209. Receiver IIP3,  $2f_1 - f_2$  vs. Tone 2 Frequency, Both Tones at  $-11$  dBFS,  $f_1 = f_2 + 2$  MHz

22382-138

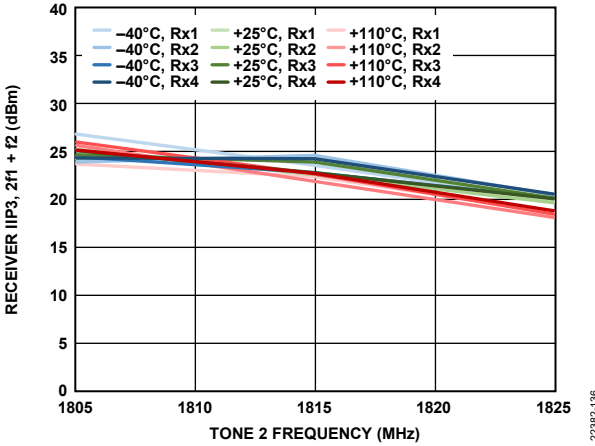

Figure 207. Receiver IIP3,  $2f_1 + f_2$  vs. Tone 2 Frequency, Both Tones at  $-11$  dBFS,  $f_1 = f_2 + 2$  MHz

22382-136

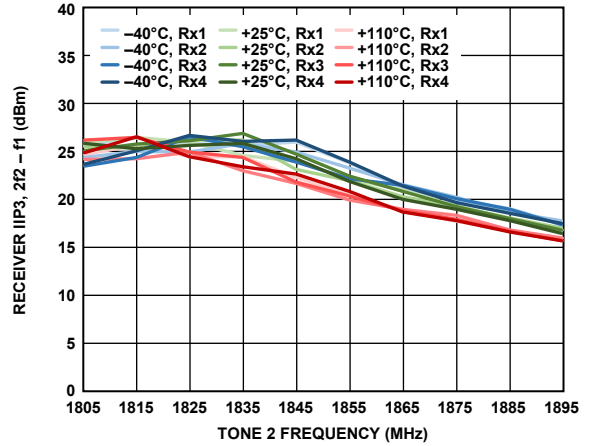

Figure 210. Receiver IIP3,  $2f_2 - f_1$  vs. Tone 2 Frequency, Both Tones at  $-11$  dBFS,  $f_1 = f_2 + 2$  MHz

22382-139

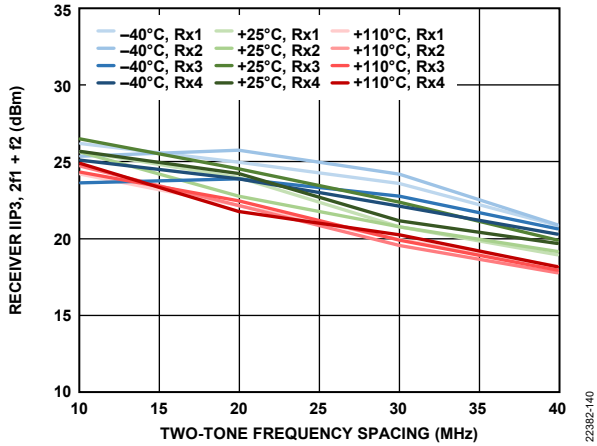

Figure 211. Receiver IIP3,  $2f_1 + f_2$  vs. Two-Tone Frequency Spacing, Both Tones at  $-11$  dBFS,  $f_2 = 2$  MHz

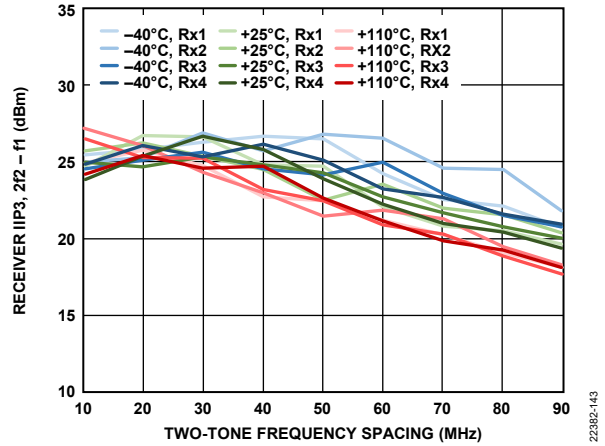

Figure 214. Receiver IIP3,  $2f_2 - f_1$  vs. Two-Tone Frequency Spacing, Both Tones at  $-11$  dBFS,  $f_2 = 2$  MHz

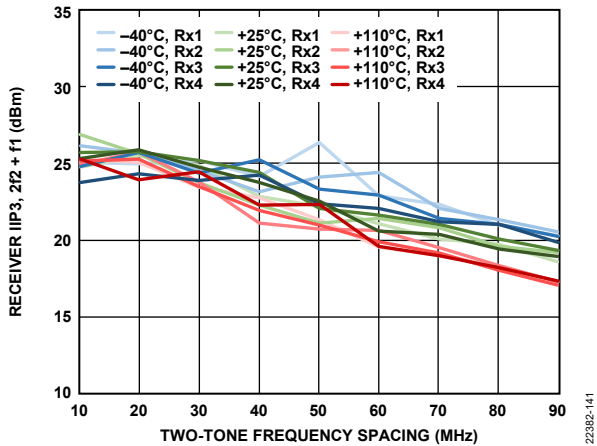

Figure 212. Receiver IIP3,  $2f_2 + f_1$  vs. Two-Tone Frequency Spacing, Both Tones at  $-11$  dBFS,  $f_2 = 2$  MHz

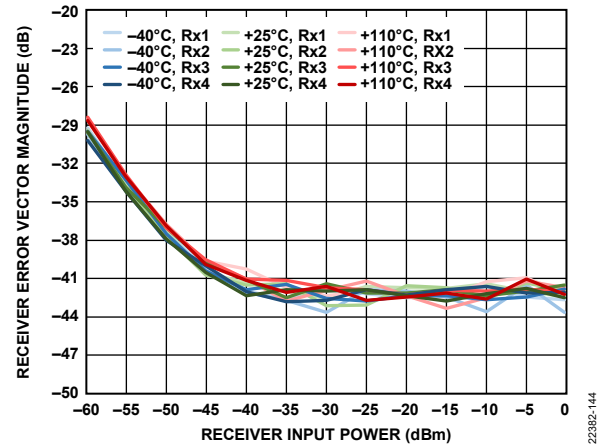

Figure 215. Receiver Error Vector Magnitude vs. Receiver Input Power, 20 MHz LTE Signal Centered at LO Frequency, Sample Rate = 245.76 MSPS, Loop Filter Bandwidth = 500 kHz, Loop Filter Phase Margin =  $60^\circ$

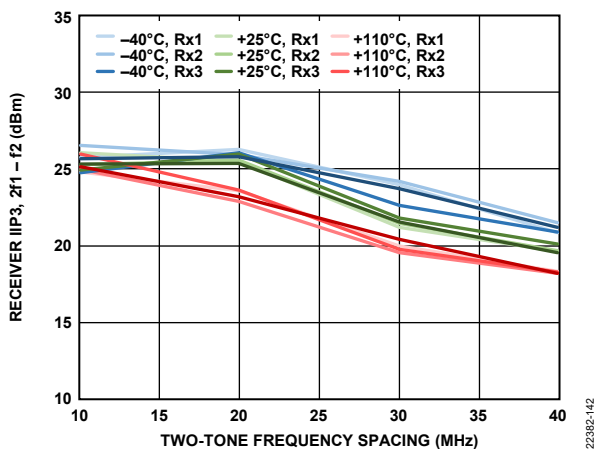

Figure 213. Receiver IIP3,  $2f_1 - f_2$  vs. Two-Tone Frequency Spacing, Both Tones at  $-11$  dBFS,  $f_2 = 2$  MHz

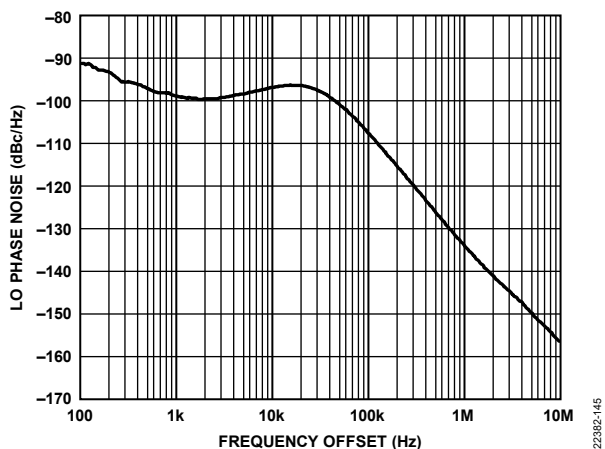

Figure 216. LO Phase Noise vs. Frequency Offset, Loop Bandwidth = 50 kHz, Phase Margin =  $85^\circ$

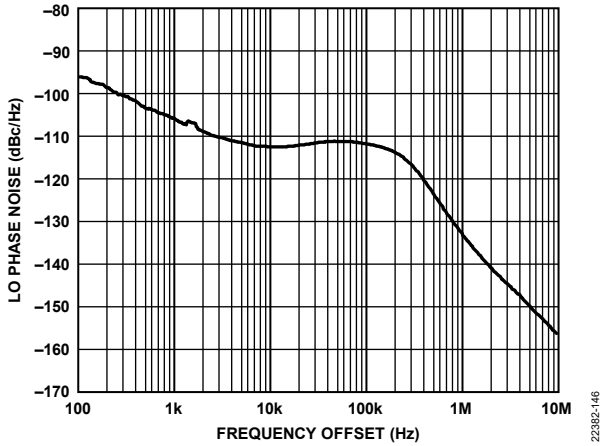

Figure 217. LO Phase Noise vs. Frequency Offset, Loop Bandwidth = 200 kHz, Phase Margin = 60°

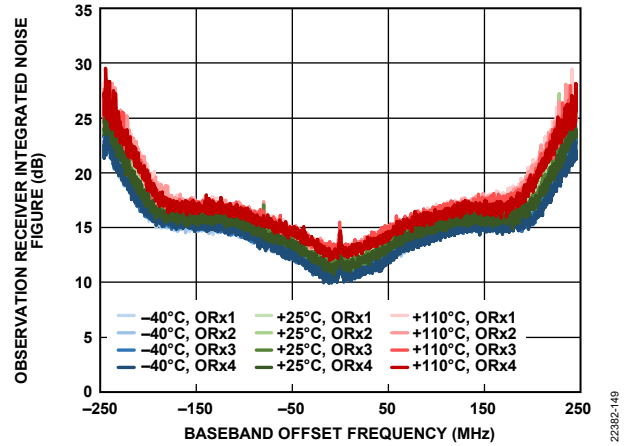

Figure 220. Observation Receiver Integrated Noise Figure vs. Baseband Offset Frequency, 450 MHz Bandwidth, Sample Rate = 491.52 MSPS, Integrated in 200 kHz Steps

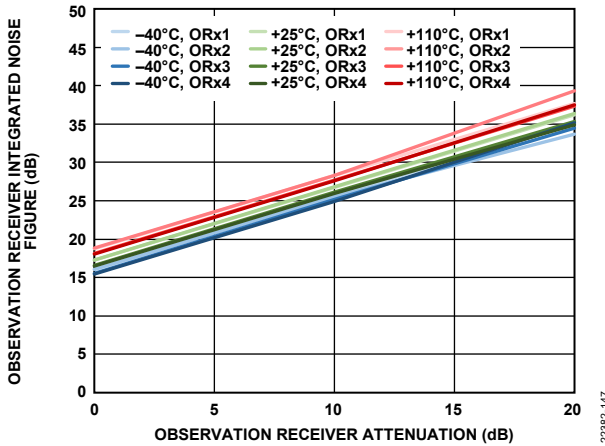

Figure 218. Observation Receiver Integrated Noise Figure vs. Observation Receiver Attenuation, 450 MHz Bandwidth, Sample Rate = 491.52 MSPS, Integration Bandwidth = 500 kHz to 245.76 MHz

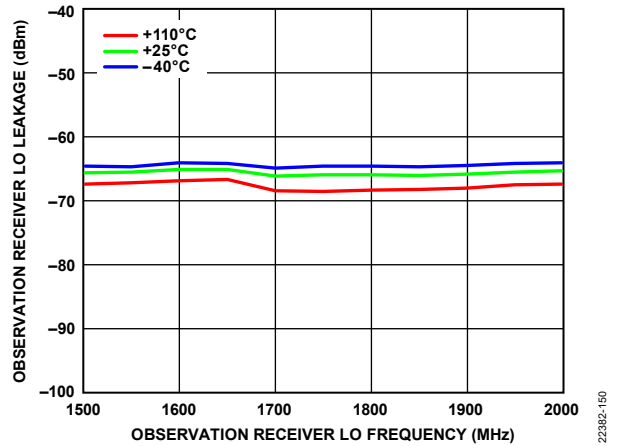

Figure 221. Observation Receiver LO Leakage vs. Observation Receiver LO Frequency, Attenuation = 0 dB, Sample Rate = 491.52 MSPS

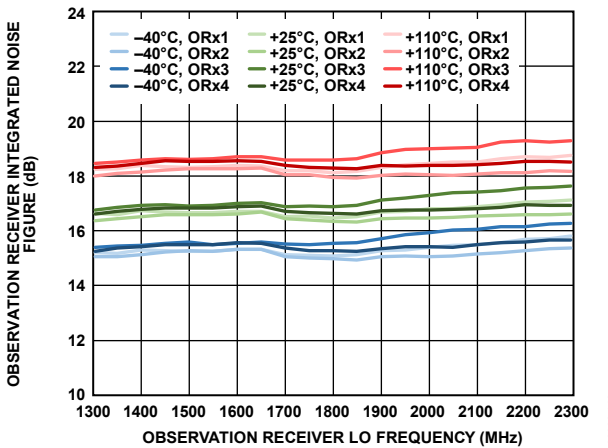

Figure 219. Observation Receiver Integrated Noise Figure vs. Observation Receiver LO Frequency, 450 MHz Bandwidth, Sample Rate = 491.52 MSPS, Integration Bandwidth = 500 kHz to 245.76 MHz

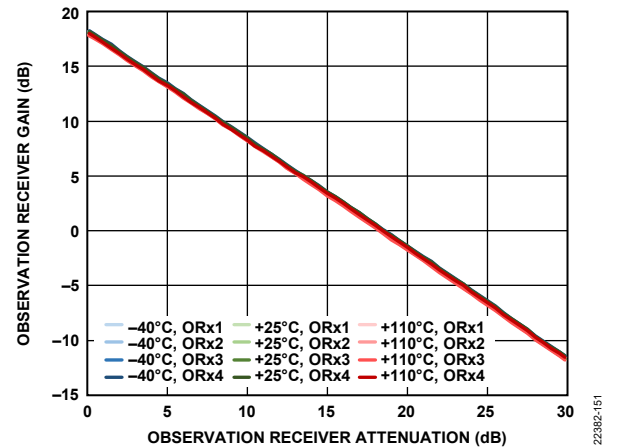

Figure 222. Observation Receiver Gain vs. Observation Receiver Attenuation, 45 MHz Offset, 450 MHz Bandwidth, Sample Rate = 491.52 MSPS

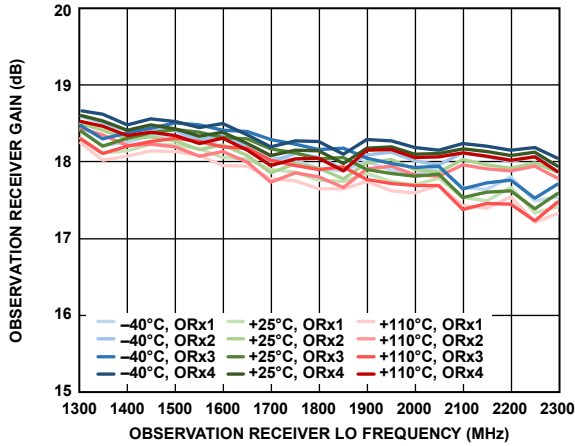

Figure 223. Observation Receiver Gain vs. Observation Receiver LO Frequency, 450 MHz Bandwidth, Sample Rate = 491.52 MSPS

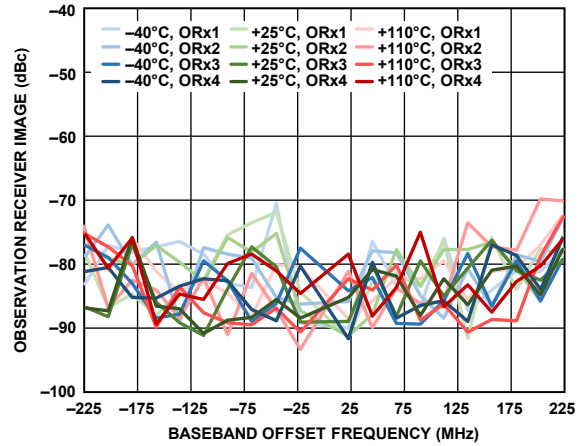

Figure 226. Observation Receiver Image vs. Baseband Offset Frequency, Tracking Calibration Active, Sample Rate = 491.52 MSPS

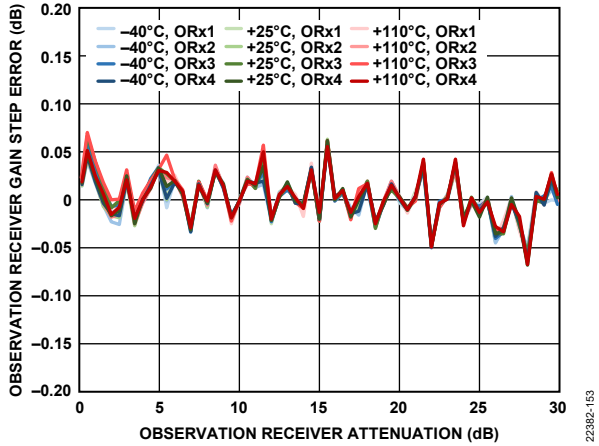

Figure 224. Observation Receiver Gain Step Error vs. Observation Receiver Attenuation, 45 MHz Offset, -10 dBFS Input Signal

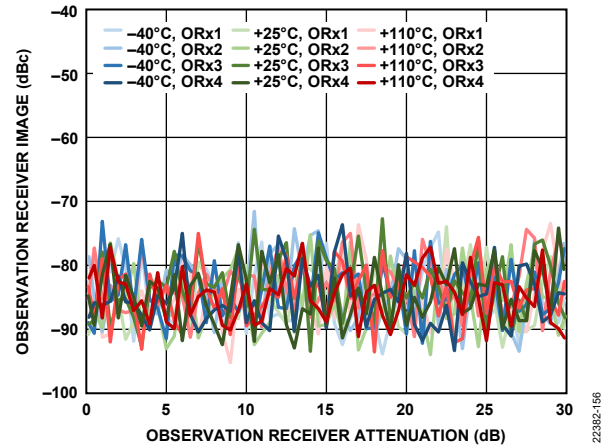

Figure 227. Observation Receiver Image vs. Observation Receiver Attenuation, 45 MHz Offset, Tracking Calibration Active, Sample Rate = 491.52 MSPS

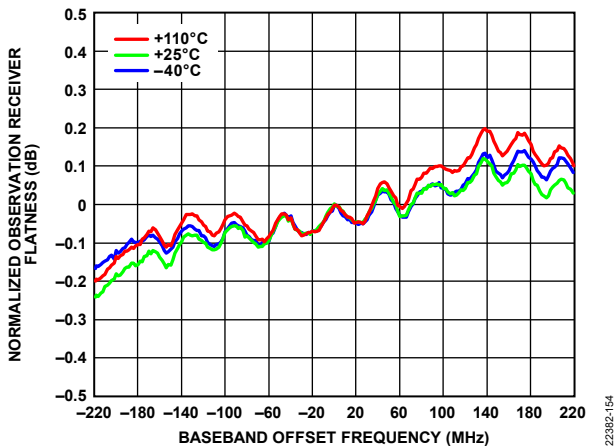

Figure 225. Normalized Observation Receiver Flatness vs. Baseband Offset Frequency, -10 dBFS Input Signal

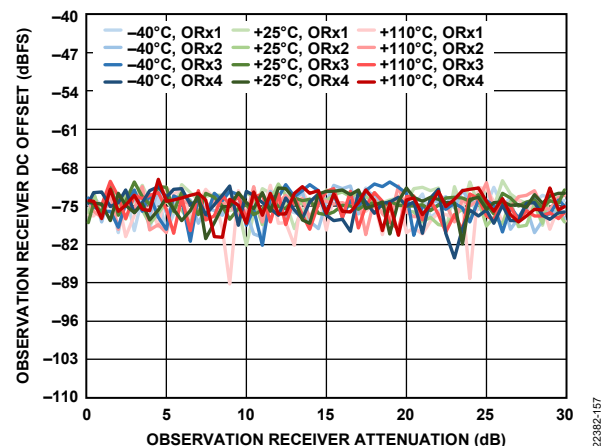

Figure 228. Observation Receiver DC Offset vs. Observation Receiver Attenuation, 45 MHz Offset, -10 dBFS Input Signal

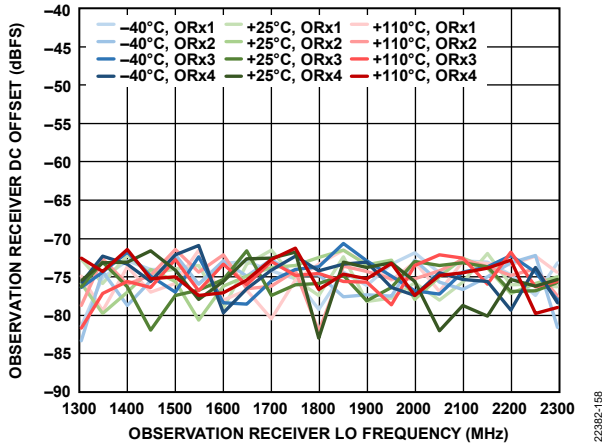

Figure 229. Observation Receiver DC Offset vs. Observation Receiver LO Frequency, Attenuation = 0 dB, Sample Rate = 491.52 MSPS

22382-158

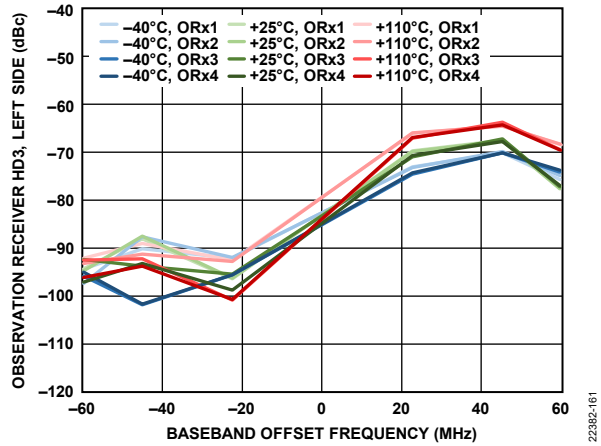

Figure 232. Observation Receiver HD3, Left Side vs. Baseband Offset Frequency, -10 dBFS Input Signal, Distortion Tone Measured Left of 0 Hz

22382-161

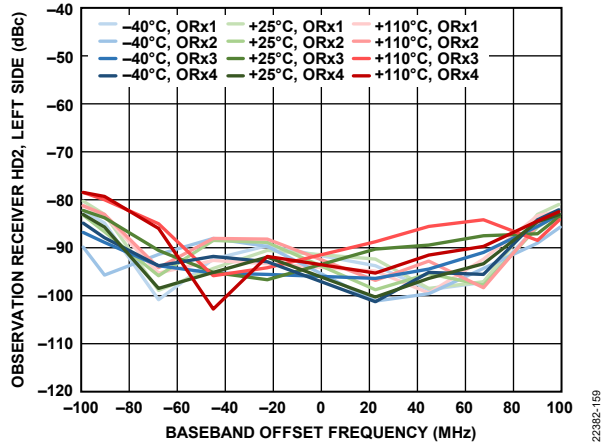

Figure 230. Observation Receiver HD2, Left Side vs. Baseband Offset Frequency, -10 dBFS Input Signal, Distortion Tone Measured Left of 0 Hz

22382-159

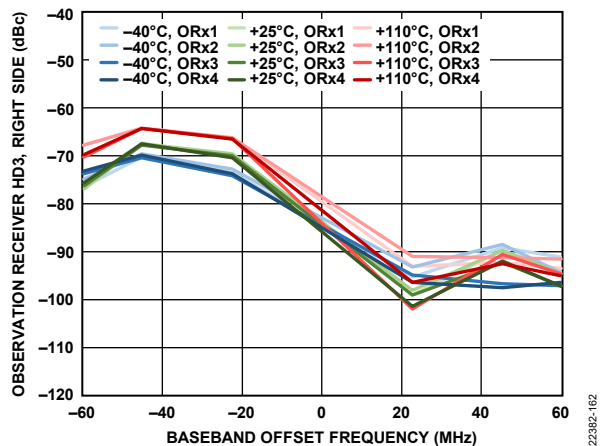

Figure 233. Observation Receiver HD3, Right Side vs. Baseband Offset Frequency, -10 dBFS Input Signal, Distortion Tone Measured Right of 0 Hz

22382-162

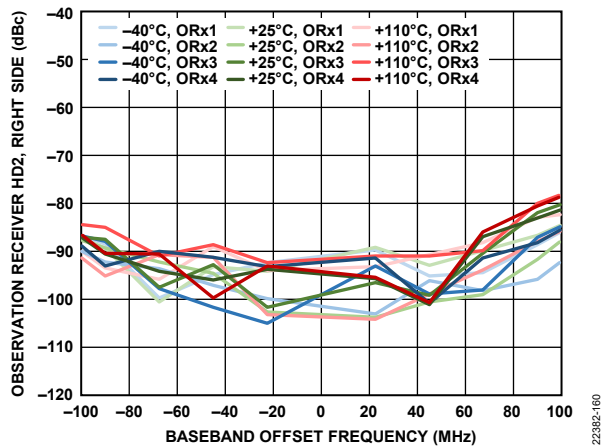

Figure 231. Observation Receiver HD2, Right Side vs. Baseband Offset Frequency, -10 dBFS Input Signal, Distortion Tone Measured Right of 0 Hz

22382-160

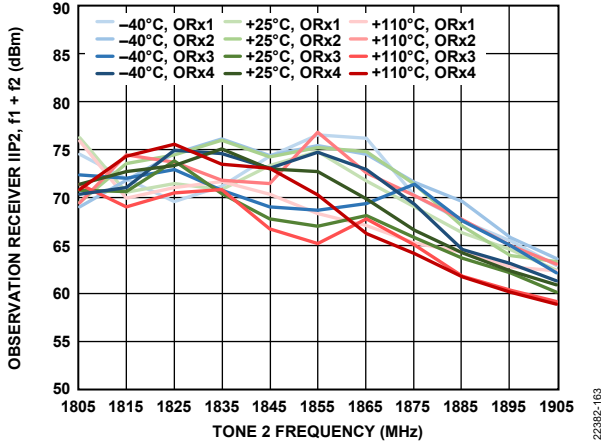

Figure 234. Observation Receiver IIP2, f1 + f2 vs. Tone 2 Frequency, Both Tones at -13 dBFS, f1 = f2 + 2 MHz

22382-163

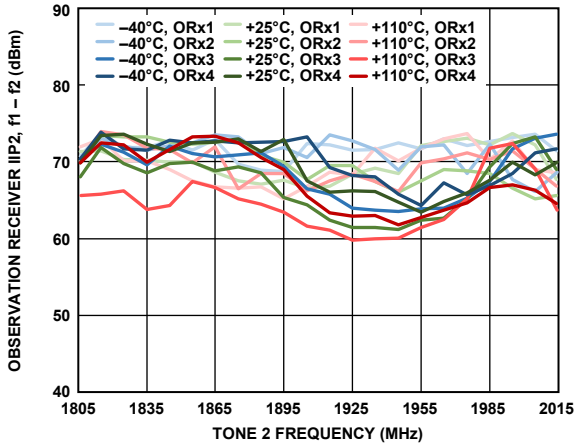

Figure 235. Observation Receiver IIP2,  $f_1 - f_2$  vs. Tone 2 Frequency, Both Tones at  $-13$  dBFS,  $f_1 = f_2 + 2$  MHz

22382-164

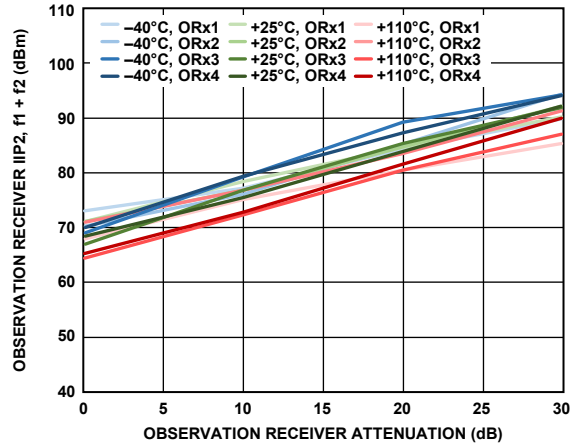

Figure 238. Observation Receiver IIP2,  $f_1 + f_2$  vs. Observation Receiver Attenuation, Both Tones at  $-13$  dBFS,  $f_1 = 102$  MHz,  $f_2 = 2$  MHz

22382-167

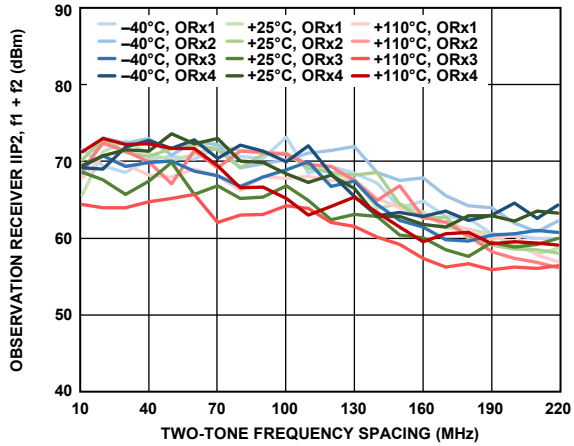

Figure 236. Observation Receiver IIP2,  $f_1 + f_2$  vs. Two-Tone Frequency Spacing, Both Tones at  $-13$  dBFS,  $f_2 = 2$  MHz

22382-165

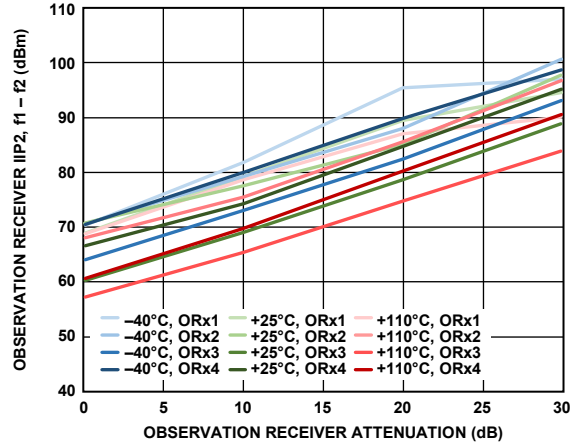

Figure 239. Observation Receiver IIP2,  $f_1 - f_2$  vs. Observation Receiver Attenuation, Both Tones at  $-13$  dBFS,  $f_1 = 102$  MHz,  $f_2 = 2$  MHz

22382-168

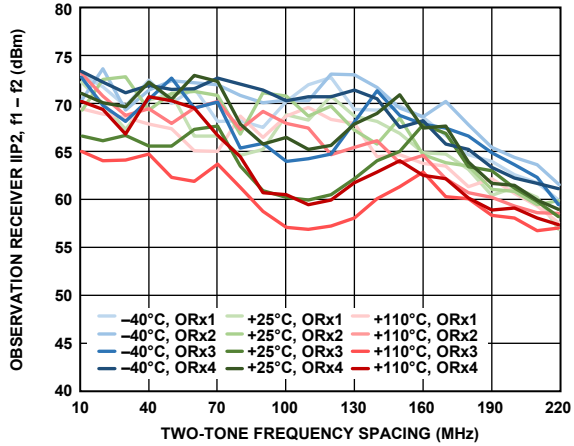

Figure 237. Observation Receiver IIP2,  $f_1 - f_2$  vs. Two-Tone Frequency Spacing, Both Tones at  $-13$  dBFS,  $f_2 = 2$  MHz

22382-166

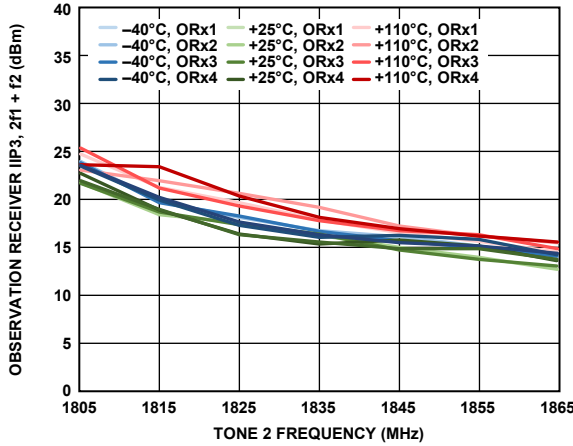

Figure 240. Observation Receiver IIP3,  $2f_1 + f_2$  vs. Tone 2 Frequency, Both Tones at  $-13$  dBFS,  $f_1 = f_2 + 2$  MHz

22382-169



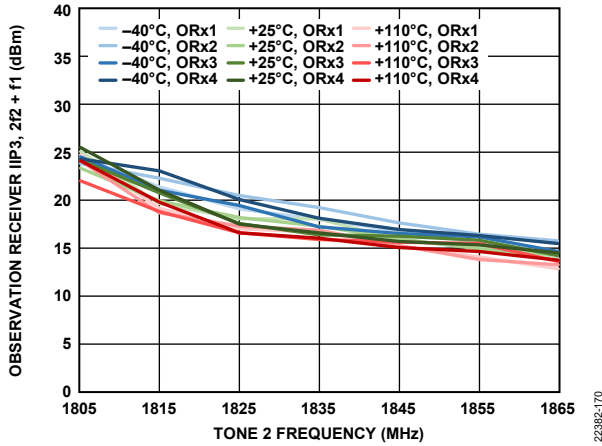

Figure 241. Observation Receiver IIP3,  $2f_2 + f_1$  vs. Tone 2 Frequency, Both Tones at  $-13$  dBFS,  $f_1 = f_2 + 2$  MHz

22382-170

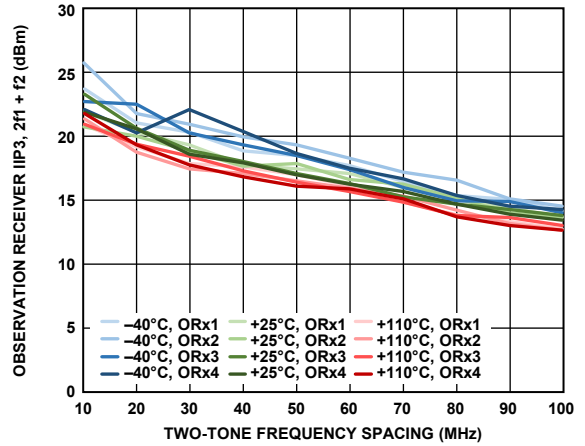

Figure 244. Observation Receiver IIP3,  $2f_1 + f_2$  vs. Two-Tone Frequency Spacing, Both Tones at  $-13$  dBFS,  $f_2 = 2$  MHz

22382-173

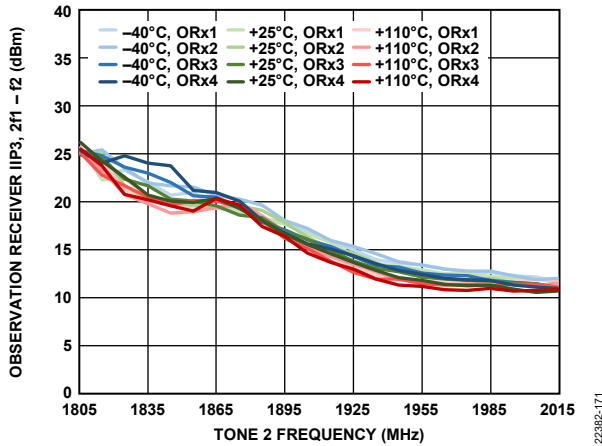

Figure 242. Observation Receiver IIP3,  $2f_1 - f_2$  vs. Tone 2 Frequency, Both Tones at  $-13$  dBFS,  $f_1 = f_2 + 2$  MHz

22382-171

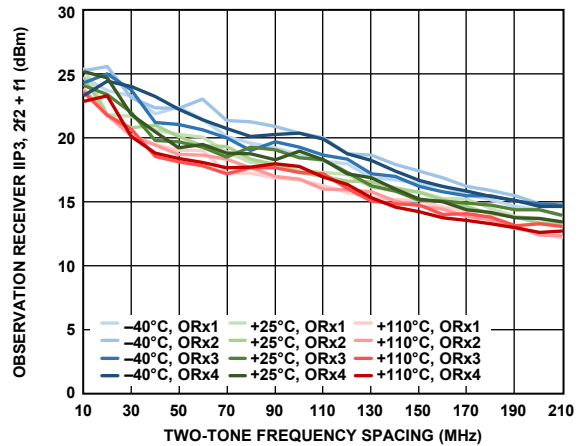

Figure 245. Observation Receiver IIP3,  $2f_2 + f_1$  vs. Two-Tone Frequency Spacing, Both Tones at  $-13$  dBFS,  $f_2 = 2$  MHz

22382-174

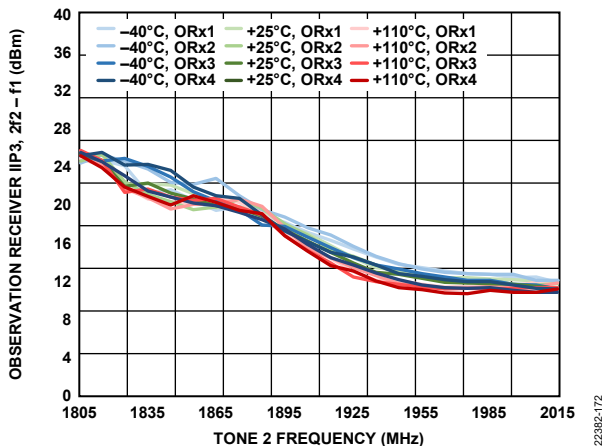

Figure 243. Observation Receiver IIP3,  $2f_2 - f_1$  vs. Tone 2 Frequency, Both Tones at  $-13$  dBFS,  $f_1 = f_2 + 2$  MHz

22382-172

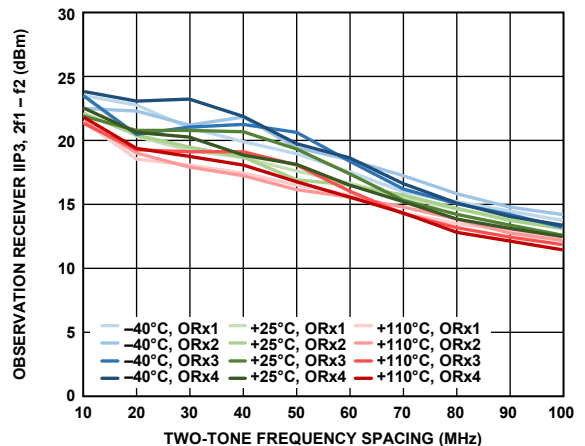
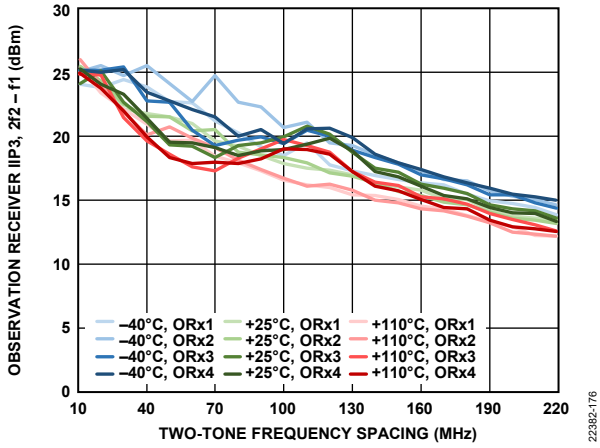

Figure 246. Observation Receiver IIP3,  $2f_1 - f_2$  vs. Two-Tone Frequency Spacing, Both Tones at  $-13$  dBFS,  $f_2 = 2$  MHz

22382-175



22382-176

Figure 247. Observation Receiver IIP3,  $2f_2 - f_1$  vs. Two-Tone Frequency Spacing, Both Tones at  $-13$  dBFS,  $f_2 = 2$  MHz

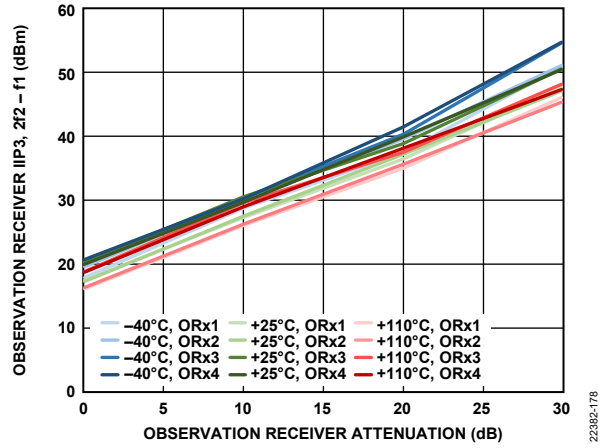

22382-176

Figure 249. Observation Receiver IIP3,  $2f_2 - f_1$  vs. Observation Receiver Attenuation, Both Tones at  $-13$  dBFS,  $f_1 = 122$  MHz,  $f_2 = 2$  MHz

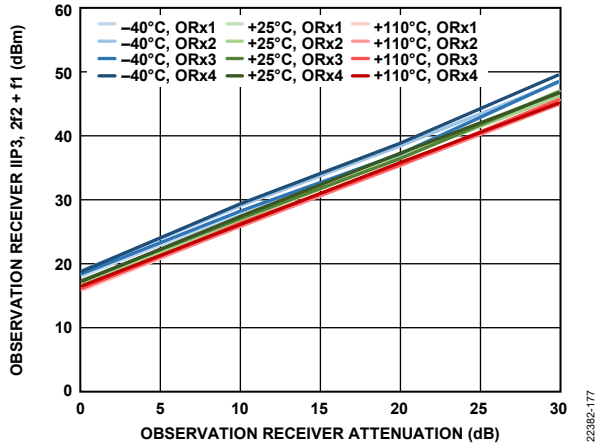

22382-177

Figure 248. Observation Receiver IIP3,  $2f_2 + f_1$  vs. Observation Receiver Attenuation, Both Tones at  $-13$  dBFS,  $f_1 = 122$  MHz,  $f_2 = 2$  MHz

**2600 MHz BAND**

Device configuration profile: receiver = 200 MHz bandwidth, I/Q rate = 245.76 MHz, transmitter = 200 MHz large signal bandwidth plus 450 MHz synthesis bandwidth, I/Q rate = 491.52 MHz, observation receiver (OR<sub>x</sub>) = 450 MHz bandwidth, I/Q rate = 491.52 MHz, device clock = 245.76 MHz, unless otherwise noted. The temperature settings refer to the die temperature. All LO frequencies set to 2600 MHz, unless otherwise noted.

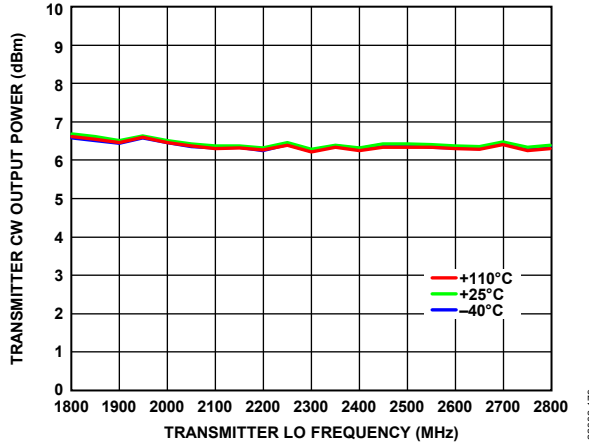

Figure 250. Transmitter Continuous Wave Output Power vs. Transmitter LO Frequency, 10 MHz Offset, 0 dB Attenuation

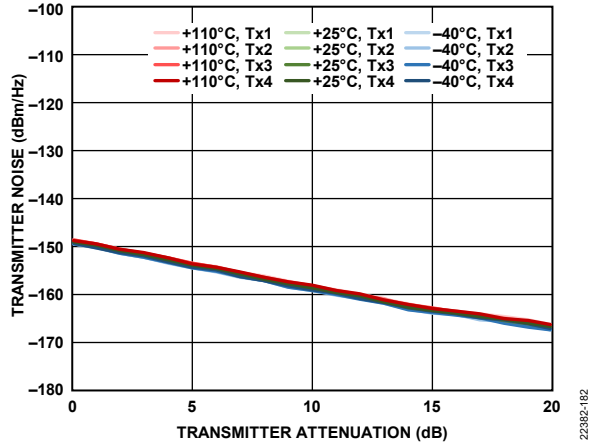

Figure 253. Transmitter Noise vs. Transmitter Attenuation, 10 MHz Offset

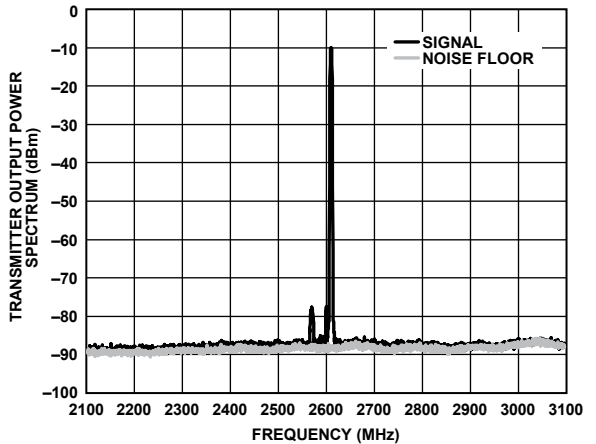

Figure 251. Transmitter Output Power Spectrum, Tx1, 5 MHz LTE, 10 MHz Offset, -10 dBFS RMS, 1 MHz Resolution Bandwidth, T<sub>j</sub> = 25°C

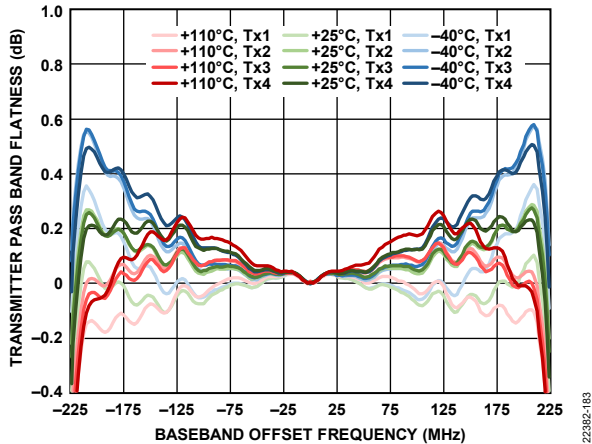

Figure 254. Transmitter Pass Band Flatness vs. Baseband Offset Frequency

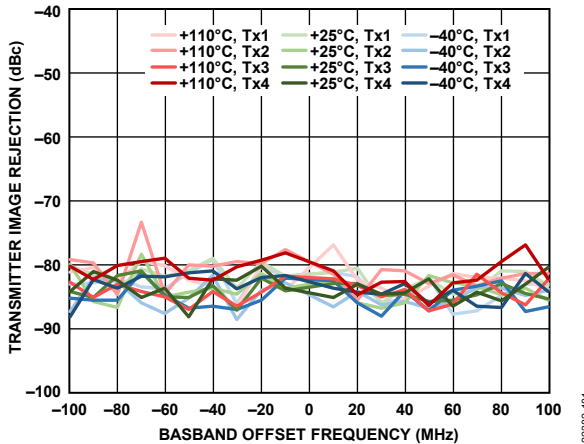

Figure 252. Transmitter Image Rejection Across Large Signal Bandwidth vs. Baseband Offset Frequency

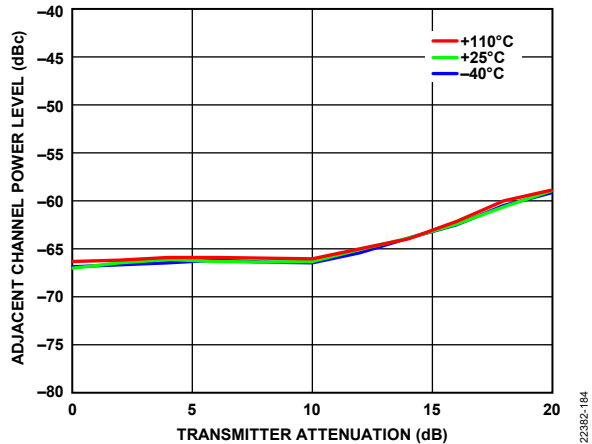

Figure 255. Adjacent Channel Power Level vs. Transmitter Attenuation, -10 MHz Baseband Offset, 20 MHz LTE, PAR = 12 dB

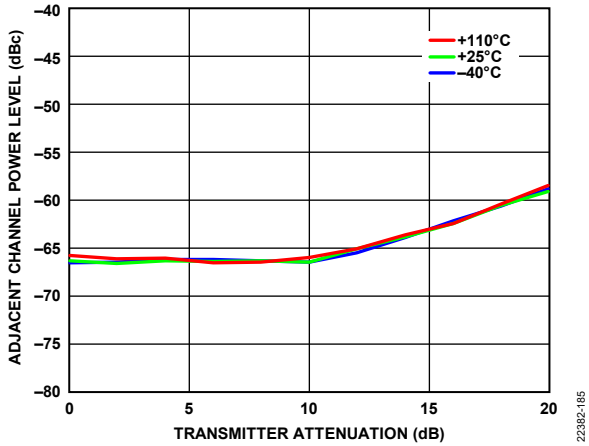

Figure 256. Adjacent Channel Power Level vs. Transmitter Attenuation, 90 MHz Baseband Offset, 20 MHz LTE, PAR = 12 dB

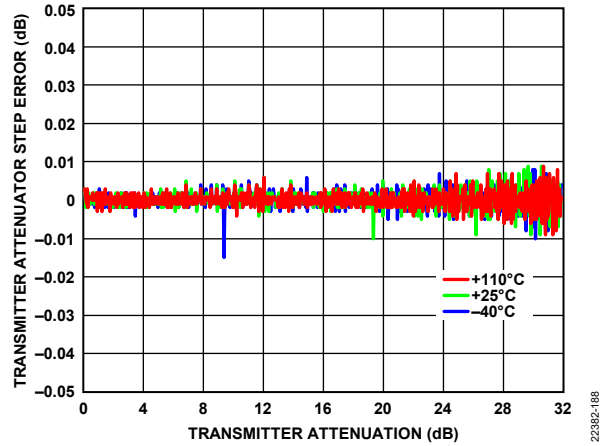

Figure 259. Transmitter Attenuator Step Error vs. Transmitter Attenuation, 10 MHz Offset

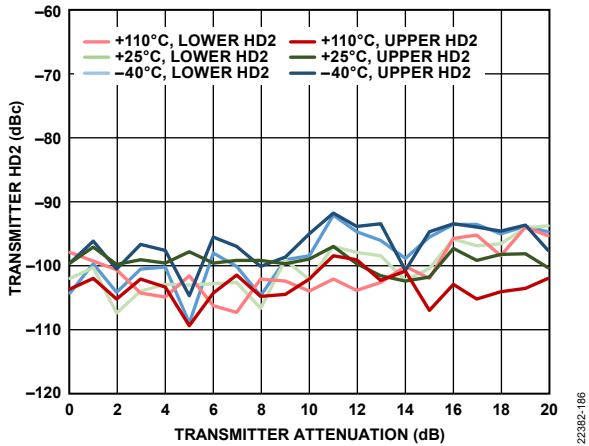

Figure 257. Transmitter Second Harmonic Distortion (HD2) vs. Transmitter Attenuation, 10 MHz Offset

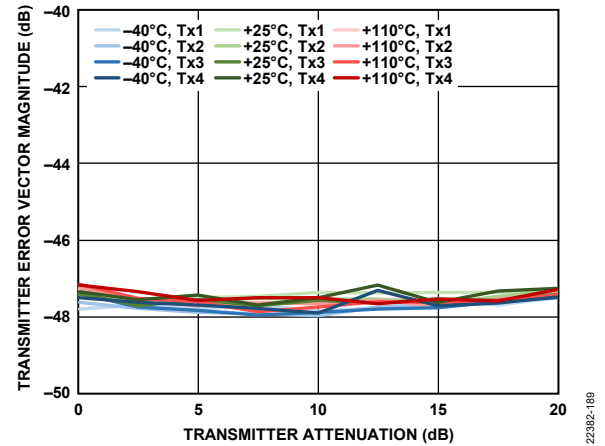

Figure 260. Transmitter Error Vector Magnitude vs. Transmitter Attenuation, 20 MHz LTE Signal Centered at LO Frequency, Sample Rate = 491.52 MSPS, Loop Filter Bandwidth = 500 kHz, Loop Filter Phase Margin = 60°

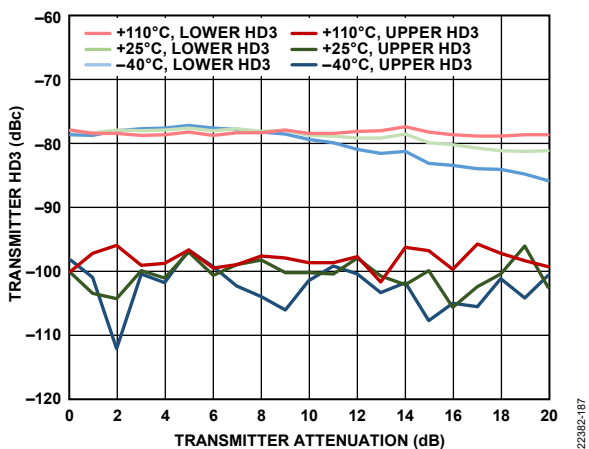

Figure 258. Transmitter Third Harmonic Distortion (HD3) vs. Transmitter Attenuation, 10 MHz Offset

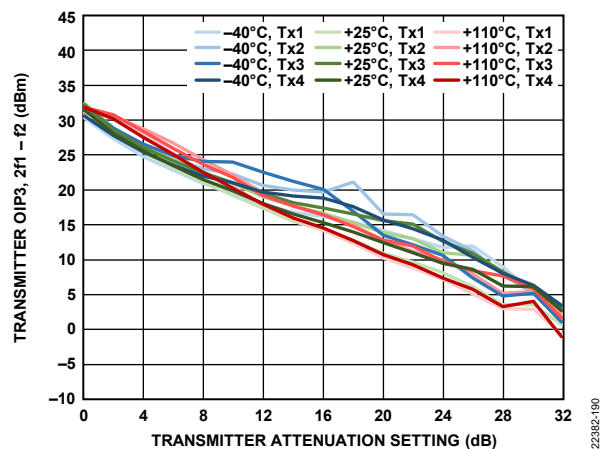

Figure 261. Transmitter OIP3, 2f1 - f2 vs. Transmitter Attenuation, 15 dB Digital Back Off per Tone, f1 = 50.5 MHz, f2 = 55.5 MHz

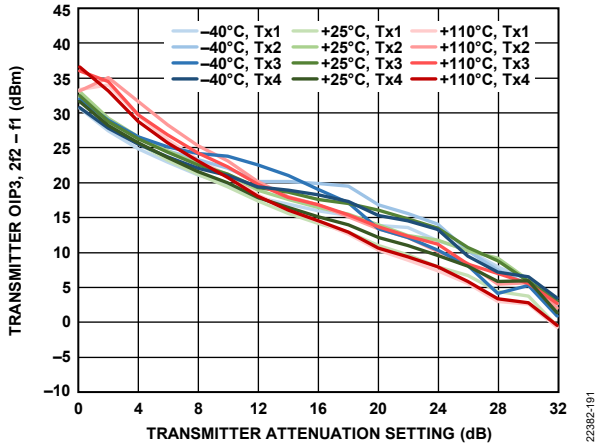

Figure 262. Transmitter OIP3,  $2f_2 - f_1$  vs. Transmitter Attenuation, 15 dB Digital Back Off per Tone,  $f_1 = 50.5$  MHz,  $f_2 = 55.5$  MHz

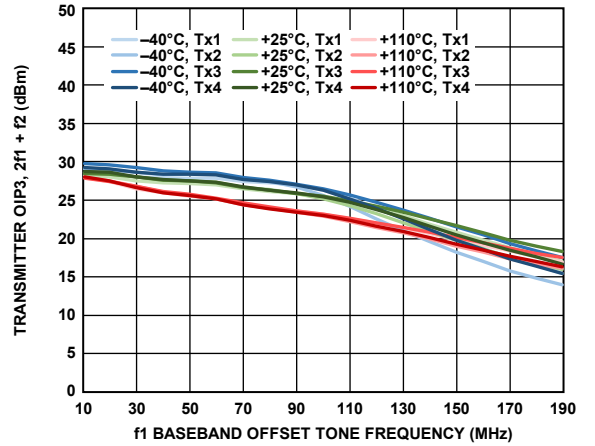

Figure 265. Transmitter OIP3,  $2f_1 + f_2$  vs.  $f_1$  Baseband Offset Tone Frequency,  $f_2 = f_1 + 5$  MHz, 15 dB Digital Back Off per Tone

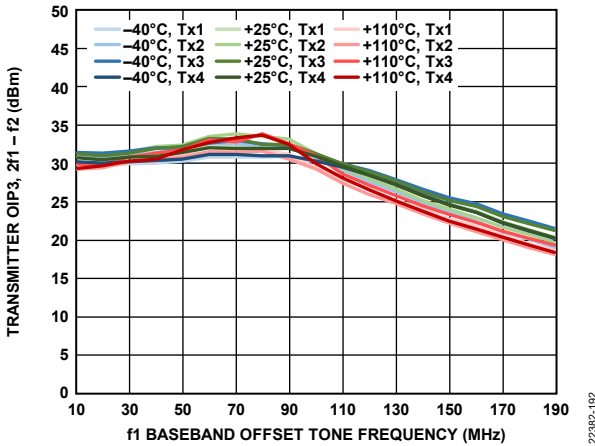

Figure 263. Transmitter OIP3,  $2f_1 - f_2$  vs.  $f_1$  Baseband Offset Tone Frequency,  $f_2 = f_1 + 5$  MHz, 15 dB Digital Back Off per Tone

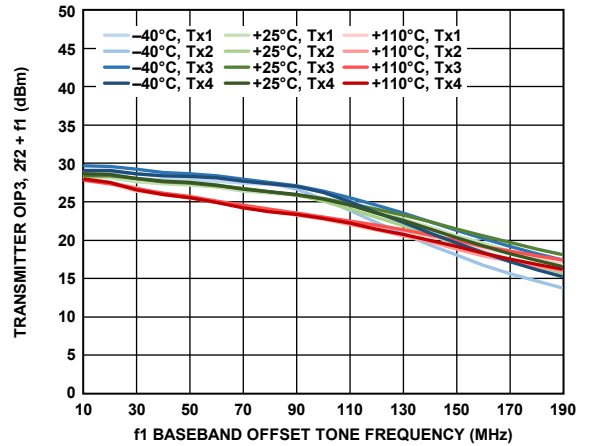

Figure 266. Transmitter OIP3,  $2f_2 + f_1$  vs.  $f_1$  Baseband Offset Tone Frequency,  $f_2 = f_1 + 5$  MHz, 15 dB Digital Back Off per Tone

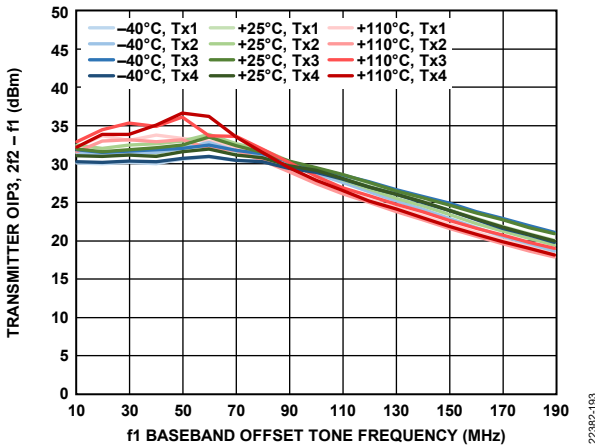

Figure 264. Transmitter OIP3,  $2f_2 - f_1$  vs.  $f_1$  Baseband Offset Tone Frequency,  $f_2 = f_1 + 5$  MHz, 15 dB Digital Back Off per Tone

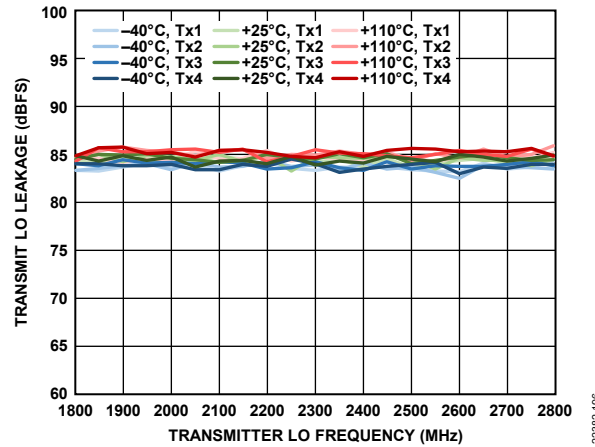

Figure 267. Transmitter LO Leakage vs. Transmitter LO Frequency

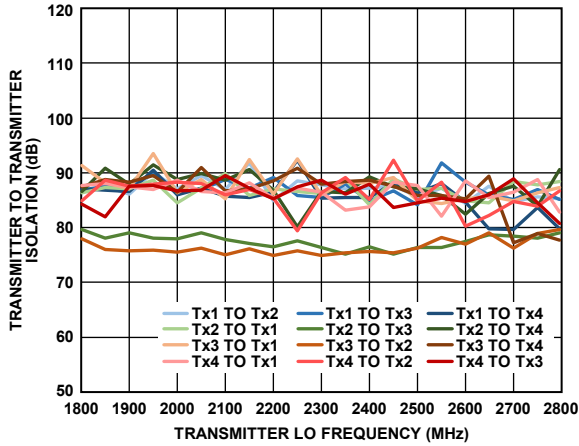

Figure 268. Transmitter to Transmitter Isolation vs. Transmitter LO Frequency

22382-197

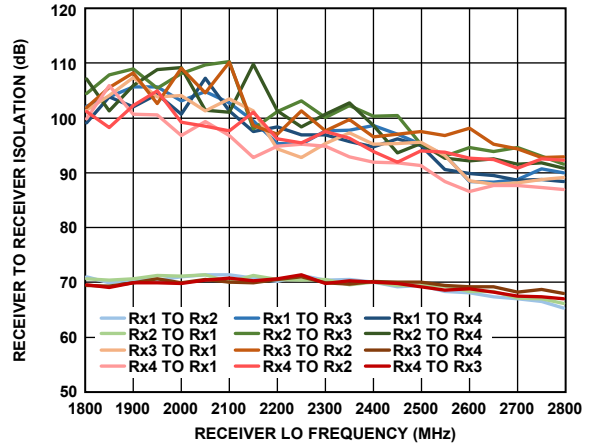

Figure 271. Receiver to Receiver Isolation vs. Receiver LO Frequency

22382-200

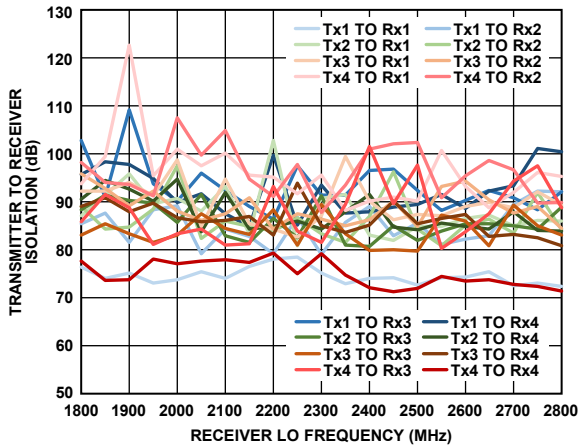

Figure 269. Transmitter to Receiver Isolation vs. Receiver LO Frequency

22382-198

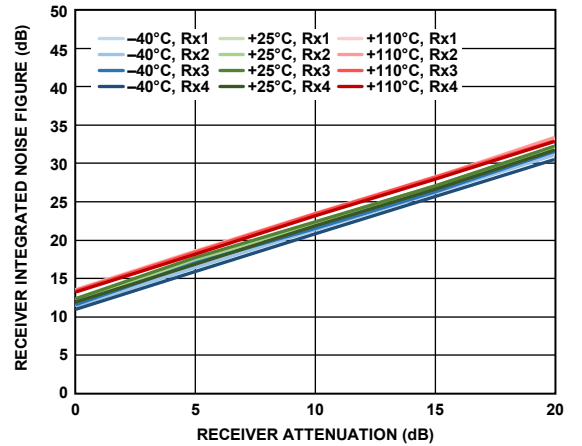

Figure 272. Receiver Integrated Noise Figure vs. Receiver Attenuation, 200 MHz Bandwidth, Sample Rate = 245.76 MSPS, Integration Bandwidth = 500 kHz to 100 MHz

22382-201

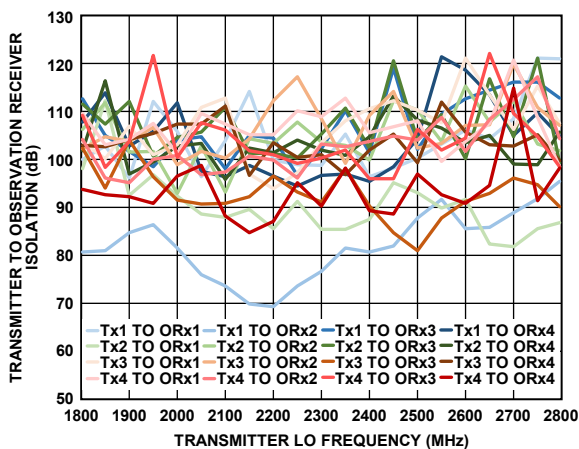

Figure 270. Transmitter to Observation Receiver Isolation vs. Transmitter LO Frequency

22382-199

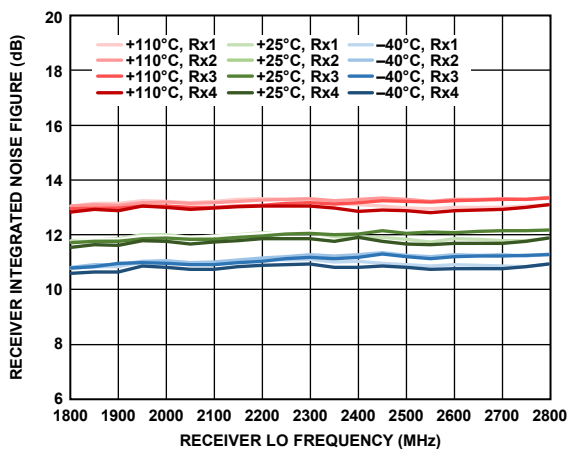

Figure 273. Receiver Integrated Noise Figure vs. Receiver LO Frequency, 200 MHz Bandwidth, Sample Rate = 245.76 MSPS, Integration Bandwidth = 500 kHz to 100 MHz

22382-202

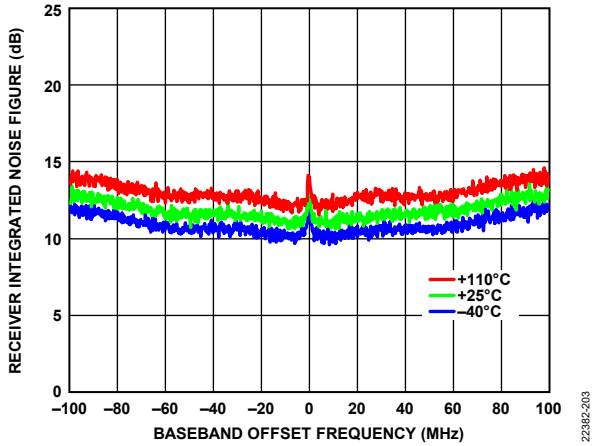

Figure 274. Receiver Integrated Noise Figure vs. Baseband Offset Frequency, 200 MHz Bandwidth, Sample Rate = 245.76 MSPS, Integrated in 200 kHz Steps

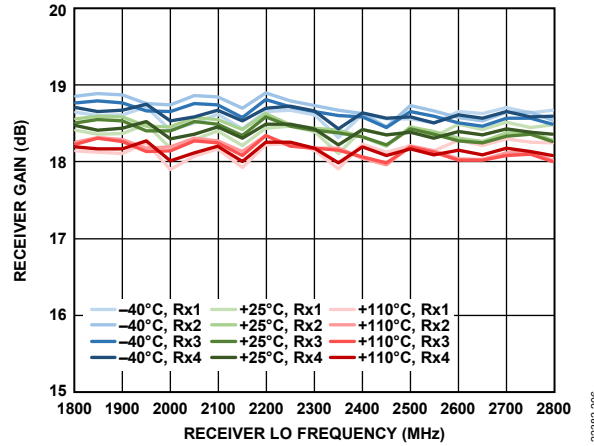

Figure 277. Receiver Gain vs. Receiver LO Frequency, 200 MHz Bandwidth, Sample Rate = 245.76 MSPS

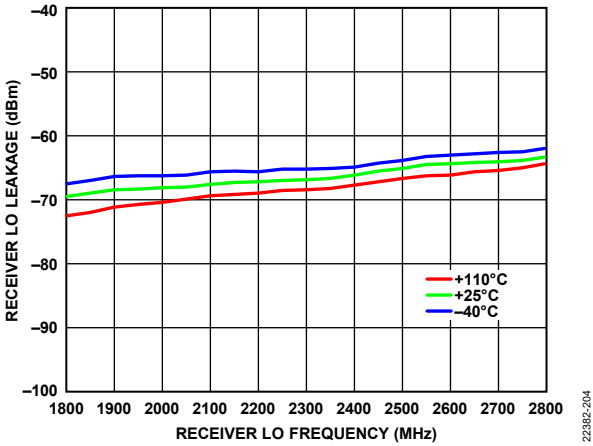

Figure 275. Receiver LO Leakage vs. Receiver LO Frequency, Attenuation = 0 dB, Sample Rate = 245.76 MSPS

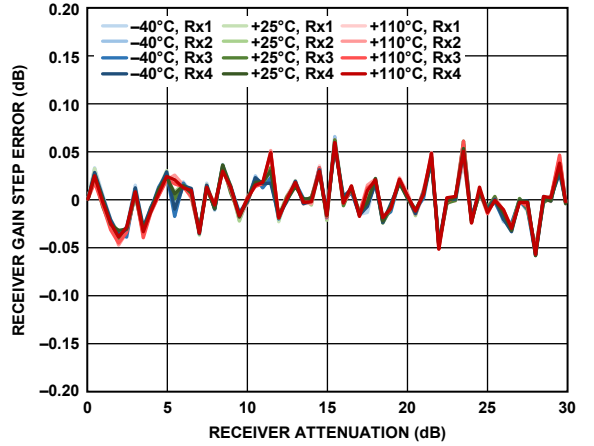

Figure 278. Receiver Gain Step Error vs. Receiver Attenuation, 20 MHz Offset, -5 dBFS Input Signal

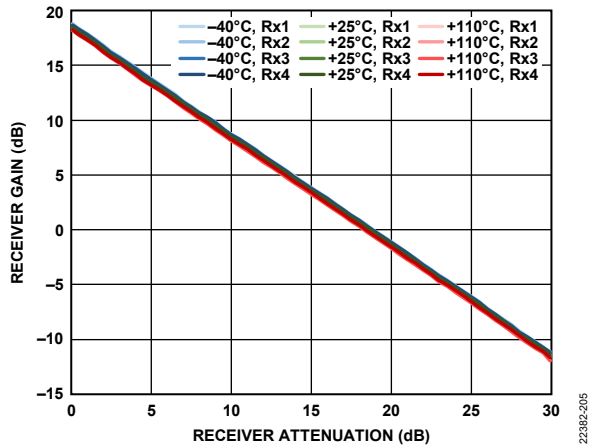

Figure 276. Receiver Gain vs. Receiver Attenuation, 20 MHz Offset, 200 MHz Bandwidth, Sample Rate = 245.76 MSPS

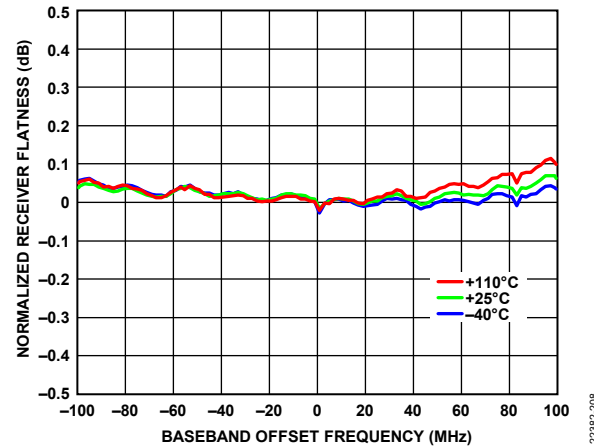

Figure 279. Normalized Receiver Flatness vs. Baseband Offset Frequency, -5 dBFS Input Signal

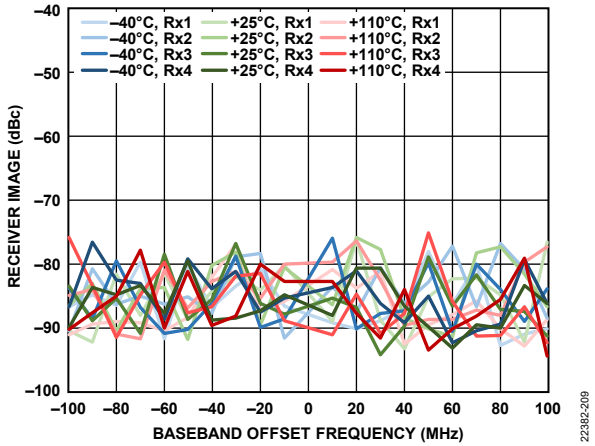

Figure 280. Receiver Image vs. Baseband Offset Frequency, Tracking Calibration Active, Sample Rate = 245.76 MSPS

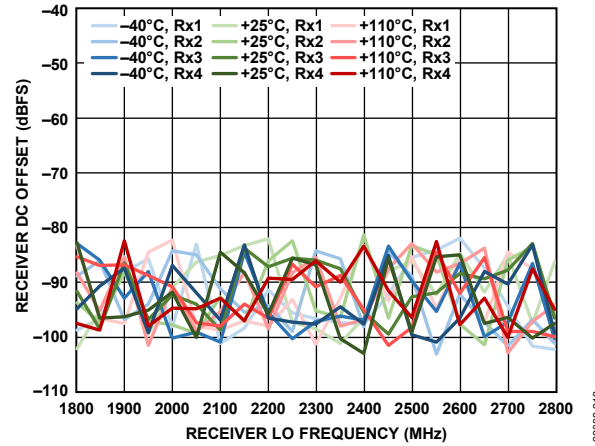

Figure 283. Receiver DC Offset vs. Receiver LO Frequency, 20 MHz Offset, -5 dBFS Input Signal

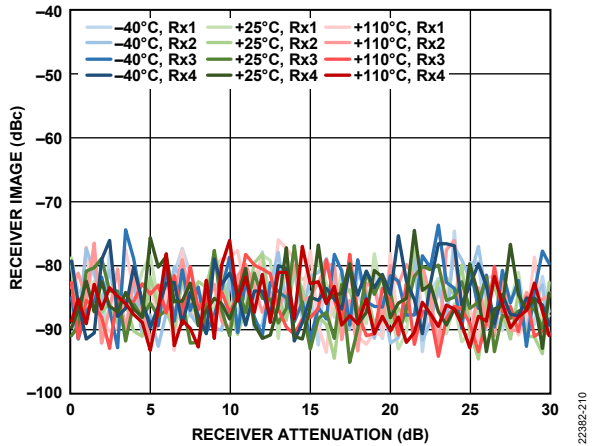

Figure 281. Receiver Image vs. Receiver Attenuation, 20 MHz Offset, Tracking Calibration Active, Sample Rate = 245.76 MSPS

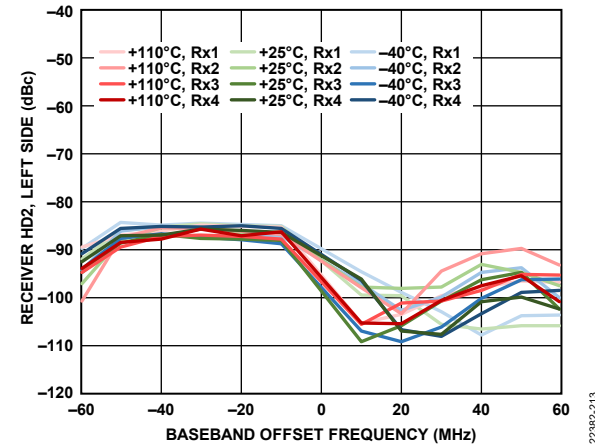

Figure 284. Receiver HD2, Left Side vs. Baseband Offset Frequency, -5 dBFS Input Signal, Distortion Tone Measured Left of 0 Hz (HD2 Canceller Not Enabled)

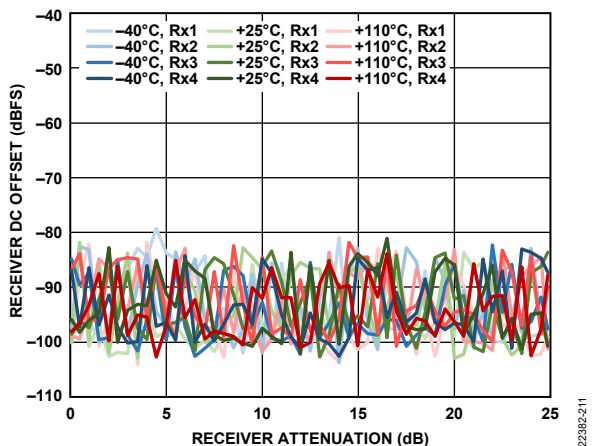

Figure 282. Receiver DC Offset vs. Receiver Attenuation, 20 MHz Offset, -5 dBFS Input Signal

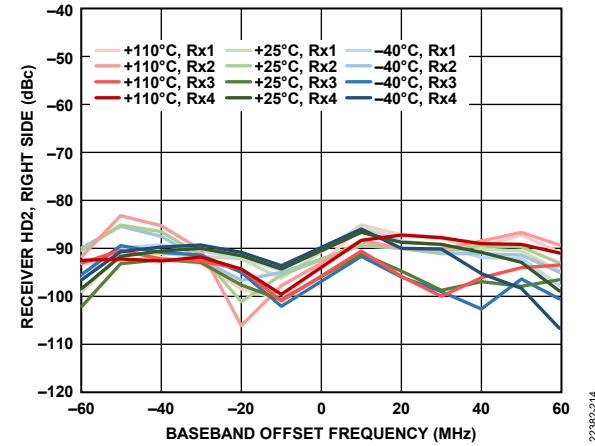

Figure 285. Receiver HD2, Right Side vs. Baseband Offset Frequency, -5 dBFS Input Signal, Distortion Tone Measured Right of 0 Hz (HD2 Canceller Not Enabled)



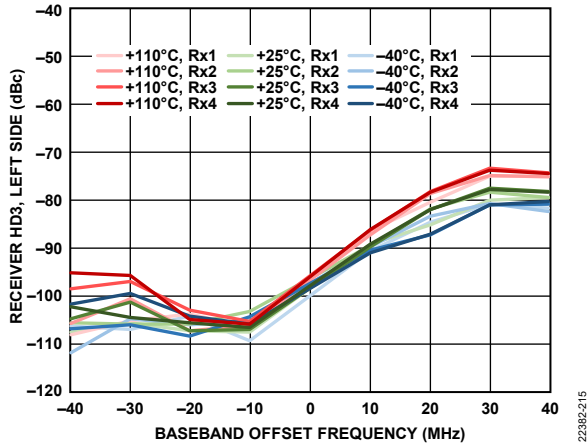

Figure 286. Receiver HD3, Left Side vs. Baseband Offset Frequency, -5 dBFS Input Signal, Distortion Tone Measured Left of 0 Hz

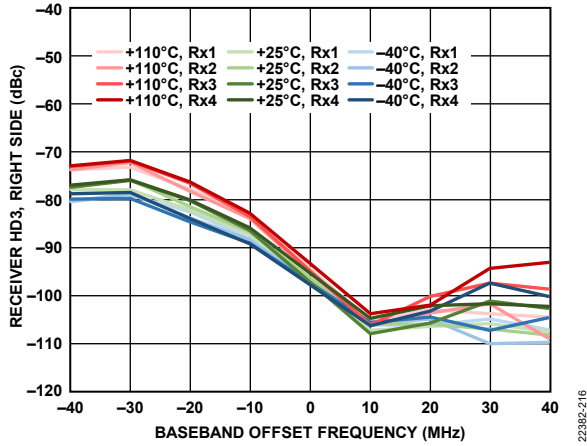

Figure 287. Receiver HD3, Right Side vs. Baseband Offset Frequency, -5 dBFS Input Signal, Distortion Tone Measured Right of 0 Hz

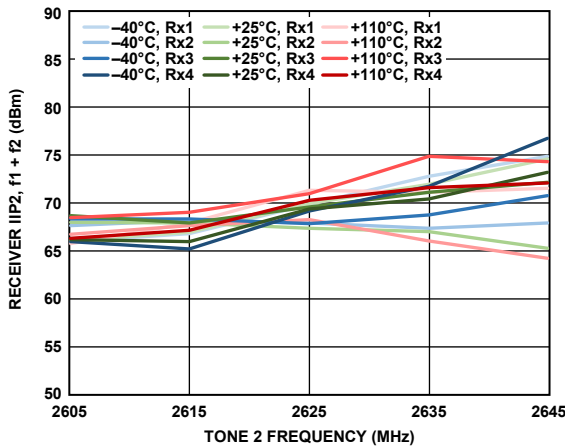

Figure 288. Receiver IIP2,  $f_1 + f_2$  vs. Tone 2 Frequency, Both Tones at -11 dBFS,  $f_1 = f_2 + 2$  MHz

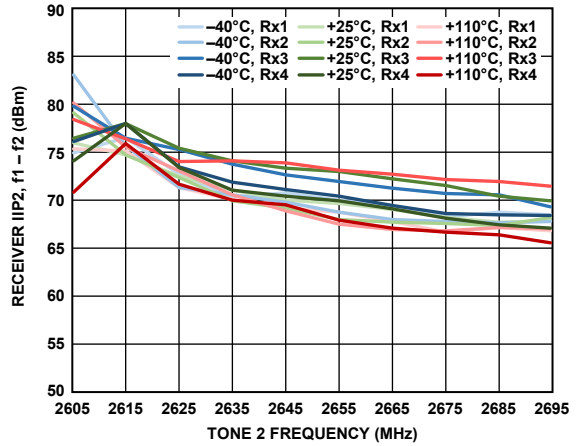

Figure 289. Receiver IIP2,  $f_1 - f_2$  vs. Tone 2 Frequency, Both Tones at -11 dBFS,  $f_1 = f_2 + 2$  MHz

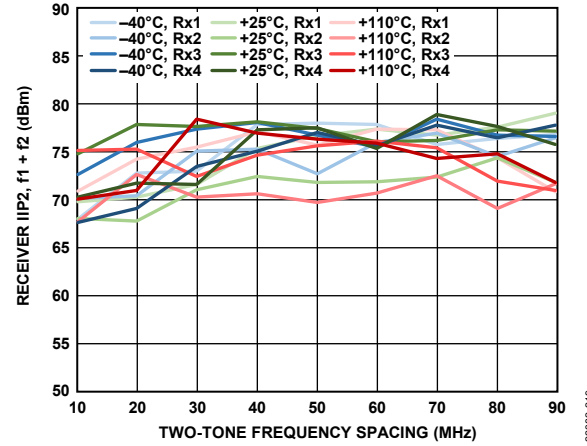

Figure 290. Receiver IIP2,  $f_1 + f_2$  vs. Two-Tone Frequency Spacing, Both Tones at -11 dBFS,  $f_2 = 2$  MHz

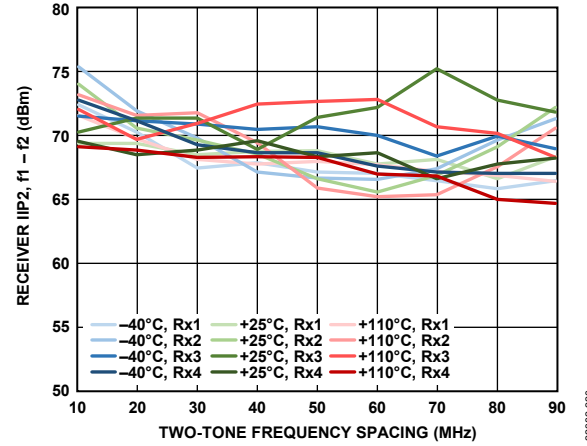

Figure 291. Receiver IIP2,  $f_1 - f_2$  vs. Two-Tone Frequency Spacing, Both Tones at -11 dBFS,  $f_2 = 2$  MHz

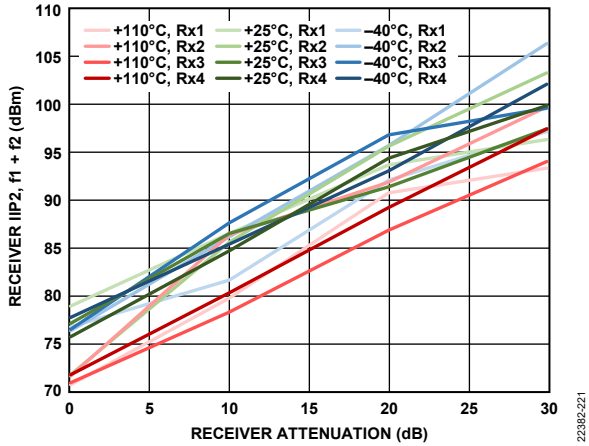

Figure 292. Receiver IIP2,  $f_1 + f_2$  vs. Receiver Attenuation, Both Tones at  $-11$  dBFS,  $f_1 = 92$  MHz,  $f_2 = 2$  MHz

22382-221

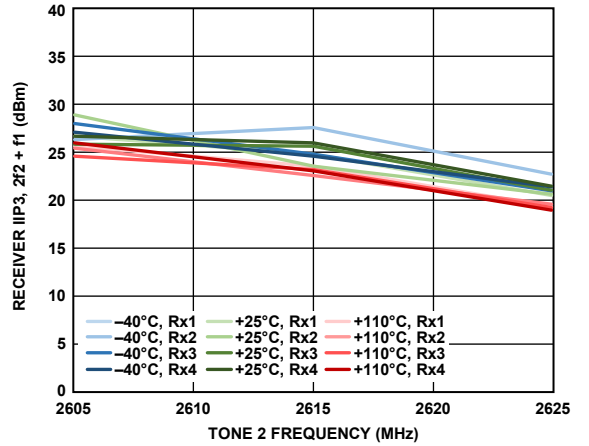

Figure 295. Receiver IIP3,  $2f_2 + f_1$  vs. Tone 2 Frequency, Both Tones at  $-11$  dBFS,  $f_1 = f_2 + 2$  MHz

22382-224

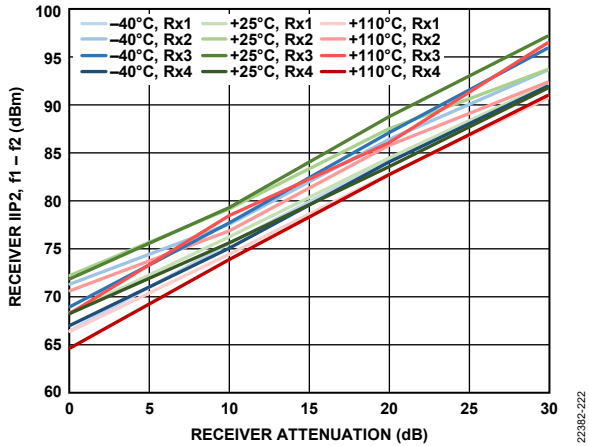

Figure 293. Receiver IIP2,  $f_1 - f_2$  vs. Receiver Attenuation, Both Tones at  $-11$  dBFS,  $f_1 = 92$  MHz,  $f_2 = 2$  MHz

22382-222

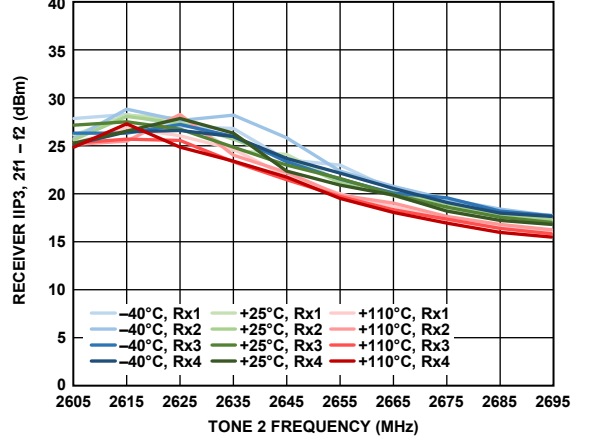

Figure 296. Receiver IIP3,  $2f_1 - f_2$  vs. Tone 2 Frequency, Both Tones at  $-11$  dBFS,  $f_1 = f_2 + 2$  MHz

22382-225

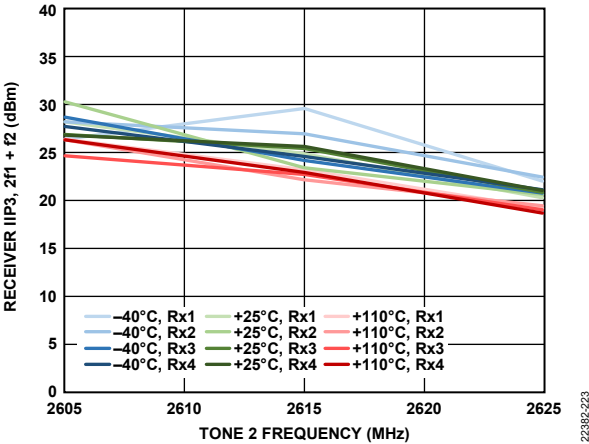

Figure 294. Receiver IIP3,  $2f_1 + f_2$  vs. Tone 2 Frequency, Both Tones at  $-11$  dBFS,  $f_1 = f_2 + 2$  MHz

22382-223

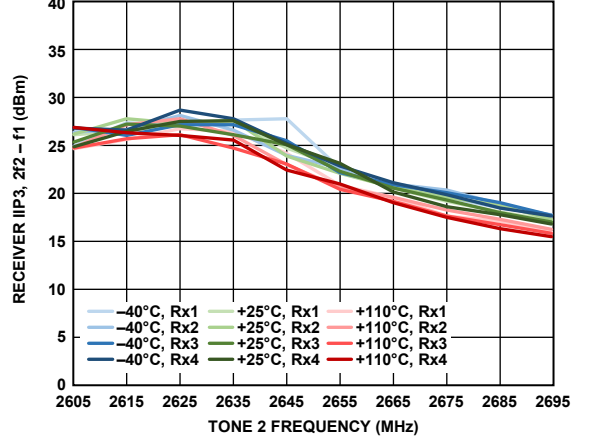

Figure 297. Receiver IIP3,  $2f_2 - f_1$  vs. Tone 2 Frequency, Both Tones at  $-11$  dBFS,  $f_1 = f_2 + 2$  MHz

22382-226

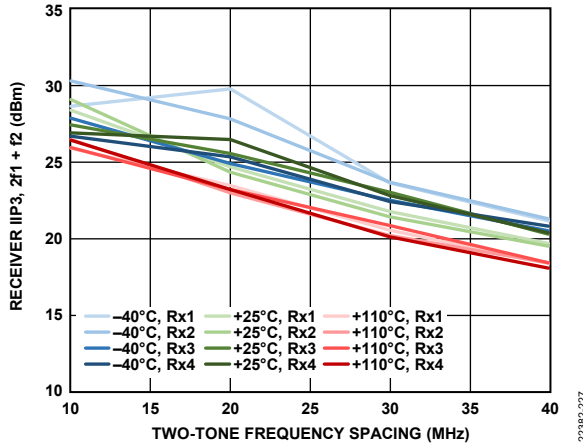

Figure 298. Receiver IIP3,  $2f_1 + f_2$  vs. Two-Tone Frequency Spacing, Both Tones at  $-11$  dBFS,  $f_2 = 2$  MHz

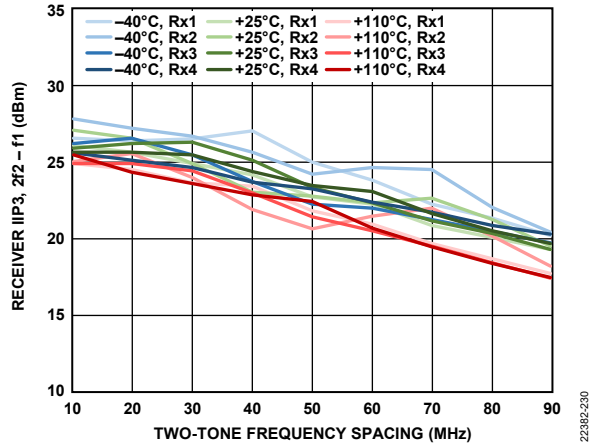

Figure 301. Receiver IIP3,  $2f_2 - f_1$  vs. Two-Tone Frequency Spacing, Both Tones at  $-11$  dBFS,  $f_2 = 2$  MHz

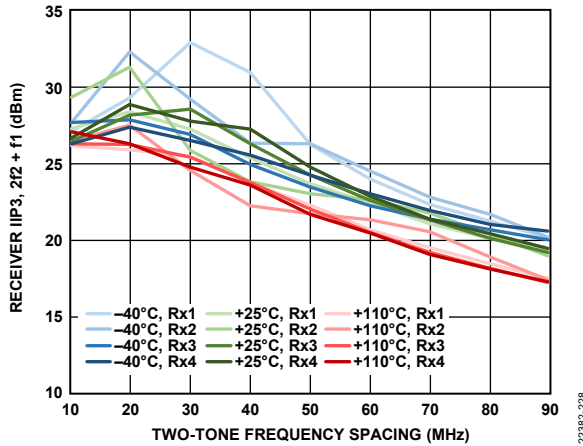

Figure 299. Receiver IIP3,  $2f_2 + f_1$  vs. Two-Tone Frequency Spacing, Both Tones at  $-11$  dBFS,  $f_2 = 2$  MHz

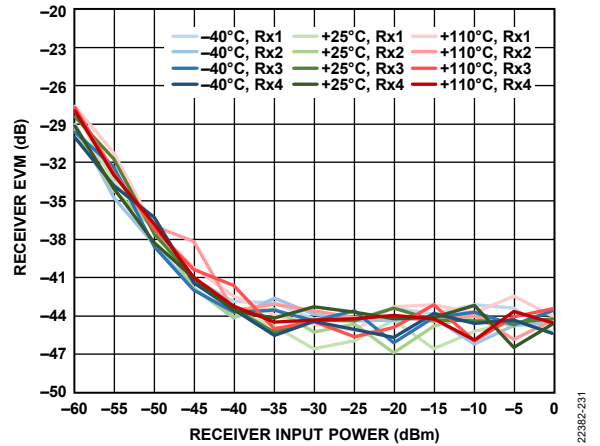

Figure 302. Receiver Error Vector Magnitude vs. Receiver Input Power, 20 MHz LTE Signal Centered at LO Frequency, Sample Rate = 245.76 MSPS, Loop Filter Bandwidth = 500 kHz, Loop Filter Phase Margin =  $60^\circ$

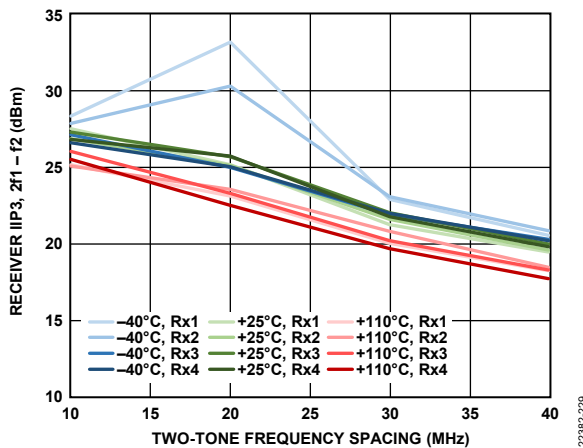

Figure 300. Receiver IIP3,  $2f_1 - f_2$  vs. Two-Tone Frequency Spacing, Both Tones at  $-11$  dBFS,  $f_2 = 2$  MHz

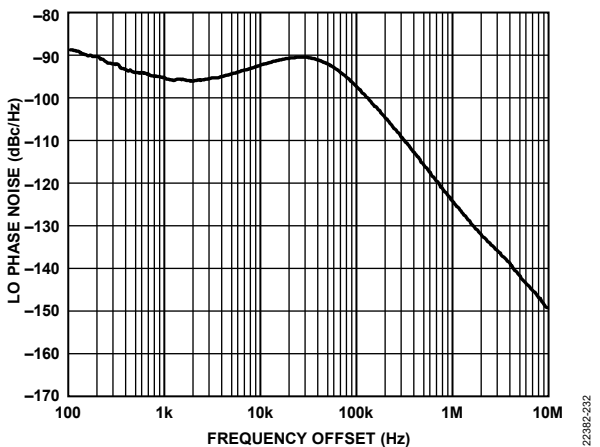

Figure 303. LO Phase Noise vs. Frequency Offset, Loop Bandwidth = 75 kHz, Phase Margin =  $85^\circ$

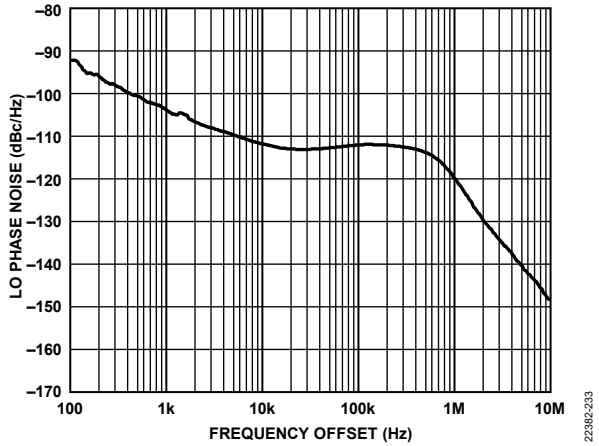

Figure 304. LO Phase Noise vs. Frequency Offset, Loop Bandwidth = 500 kHz, Phase Margin = 60°

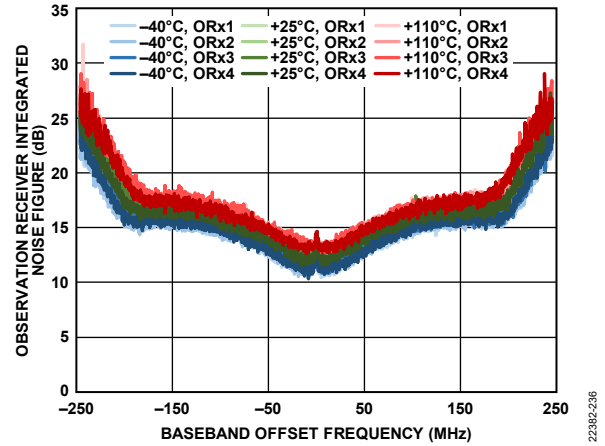

Figure 307. Observation Receiver Integrated Noise Figure vs. Baseband Offset Frequency, 450 MHz Bandwidth, Sample Rate = 491.52 MSPS, Integrated in 200 kHz Steps

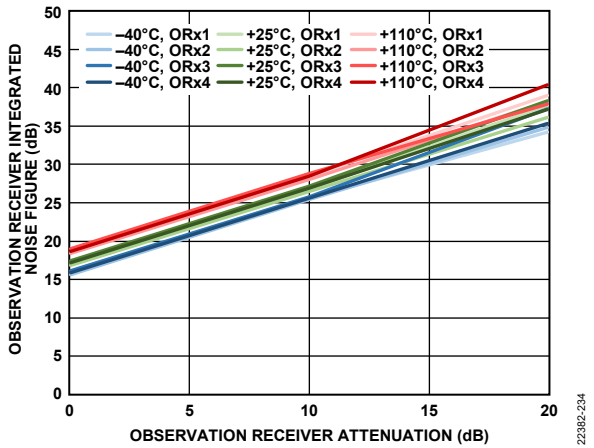

Figure 305. Observation Receiver Integrated Noise Figure vs. Observation Receiver Attenuation, 450 MHz Bandwidth, Sample Rate = 491.52 MSPS, Integration Bandwidth = 500 kHz to 245.76 MHz

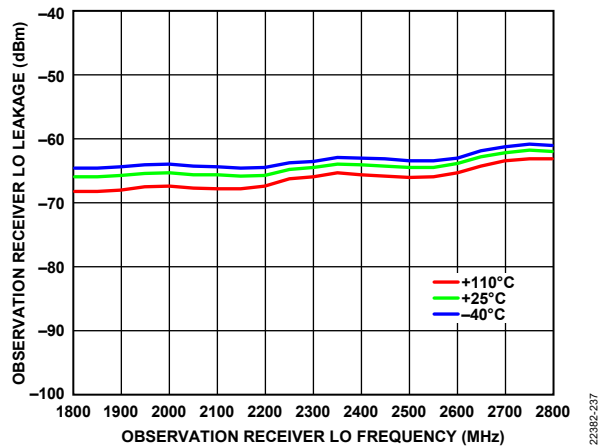

Figure 308. Observation Receiver LO Leakage vs. Observation Receiver LO Frequency, Attenuation = 0 dB, Sample Rate = 491.52 MSPS

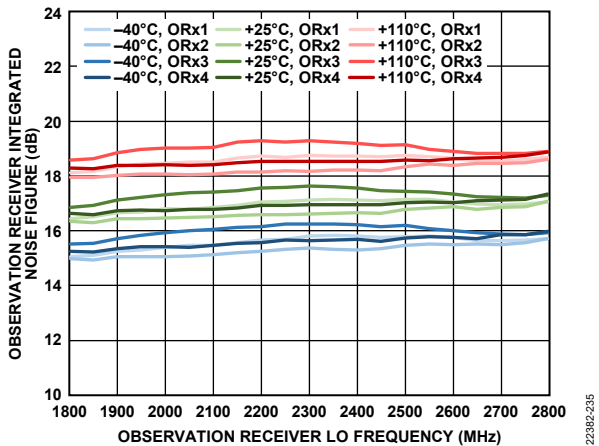

Figure 306. Observation Receiver Integrated Noise Figure vs. Observation Receiver LO Frequency, 450 MHz Bandwidth, Sample Rate = 491.52 MSPS, Integration Bandwidth = 500 kHz to 245.76 MHz

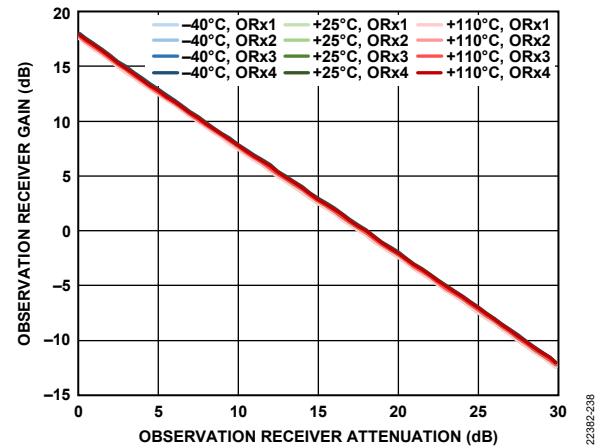

Figure 309. Observation Receiver Gain vs. Observation Receiver Attenuation, 45 MHz Offset, 450 MHz Bandwidth, Sample Rate = 491.52 MSPS

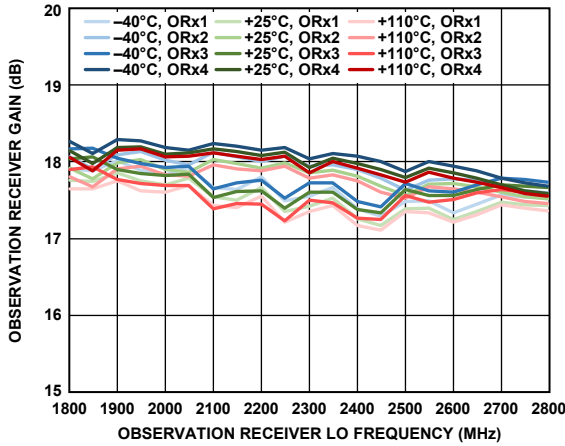

Figure 310. Observation Receiver Gain vs. Observation Receiver LO Frequency, 450 MHz Bandwidth, Sample Rate = 491.52 MSPS

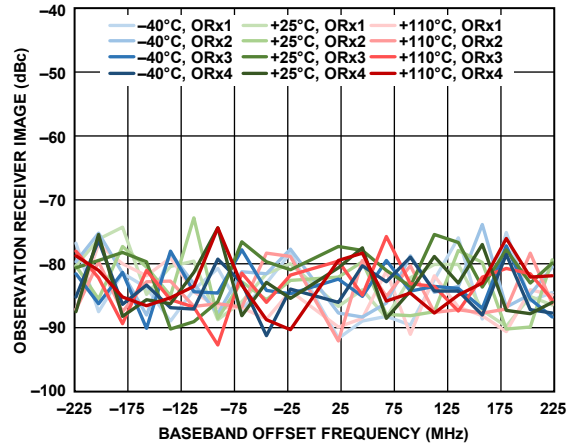

Figure 313. Observation Receiver Image vs. Baseband Offset Frequency, Tracking Calibration Active, Sample Rate = 491.52 MSPS

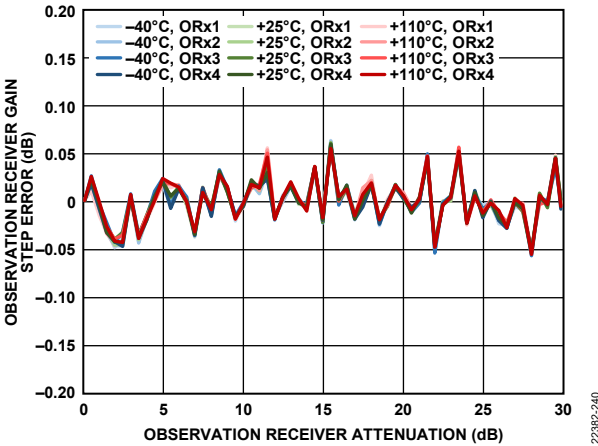

Figure 311. Observation Receiver Gain Step Error vs. Observation Receiver Attenuation, 45 MHz Offset, -10 dBFS Input Signal

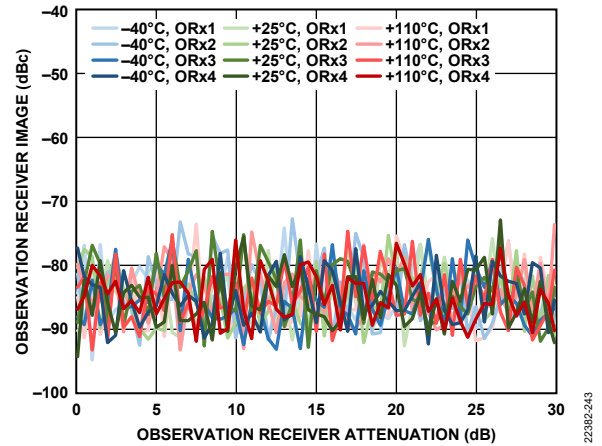

Figure 314. Observation Receiver Image vs. Observation Receiver Attenuation, 45 MHz Offset, Tracking Calibration Active, Sample Rate = 491.52 MSPS

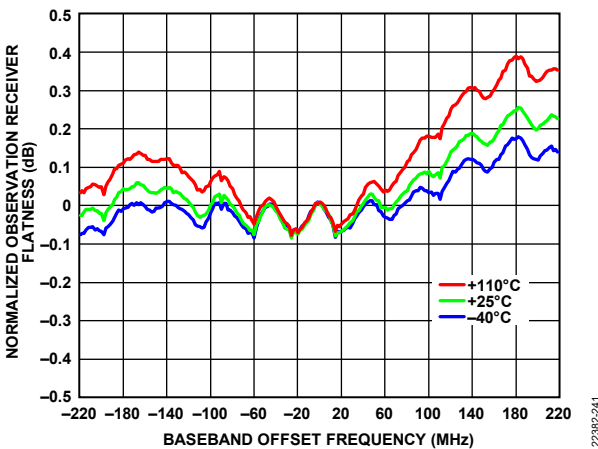

Figure 312. Normalized Observation Receiver Flatness vs. Baseband Offset Frequency, -10 dBFS Input Signal

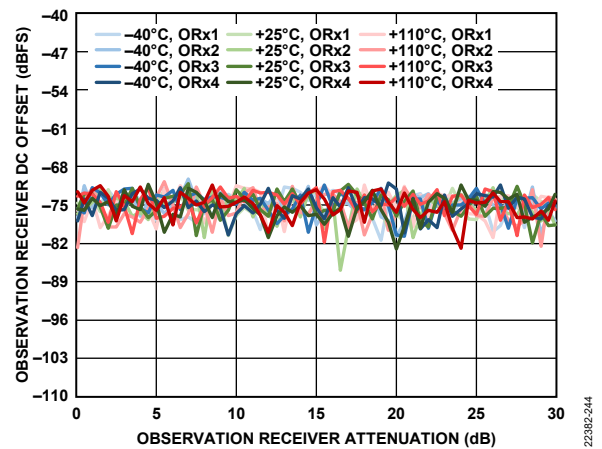

Figure 315. Observation Receiver DC Offset vs. Observation Receiver Attenuation, 45 MHz Offset, -10 dBFS Input Signal

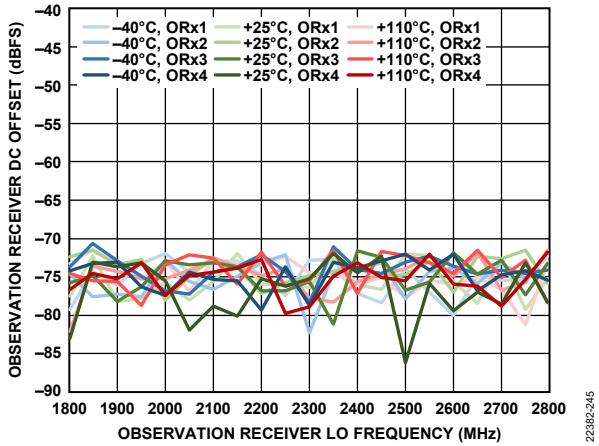

Figure 316. Observation Receiver DC Offset vs. Observation Receiver LO Frequency, Attenuation = 0 dB, Sample Rate = 491.52 MSPS

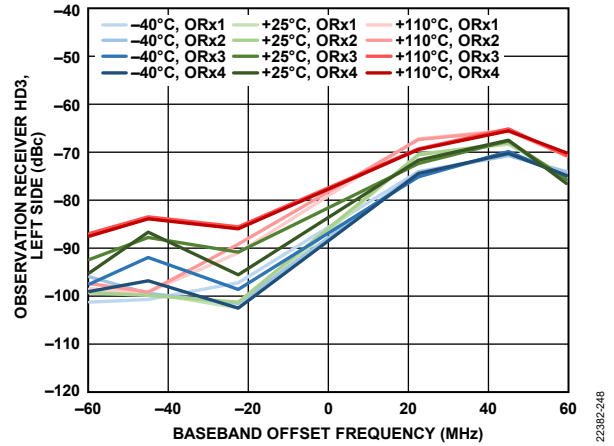

Figure 319. Observation Receiver HD3, Left Side vs. Baseband Offset Frequency, -10 dBFS Input Signal, Distortion Tone Measured Left of 0 Hz

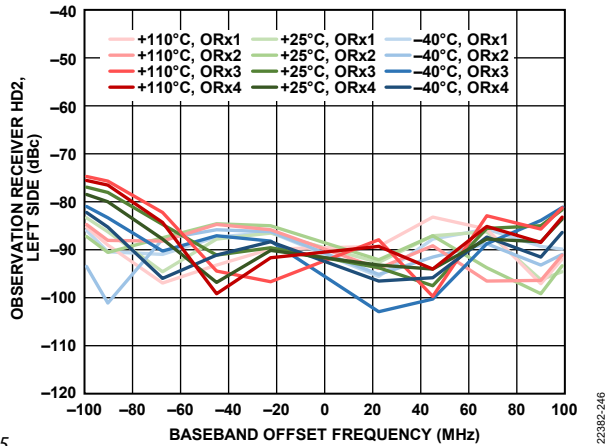

Figure 317. Observation Receiver HD2, Left Side vs. Baseband Offset Frequency, -10 dBFS Input Signal, Distortion Tone Measured Left of 0 Hz

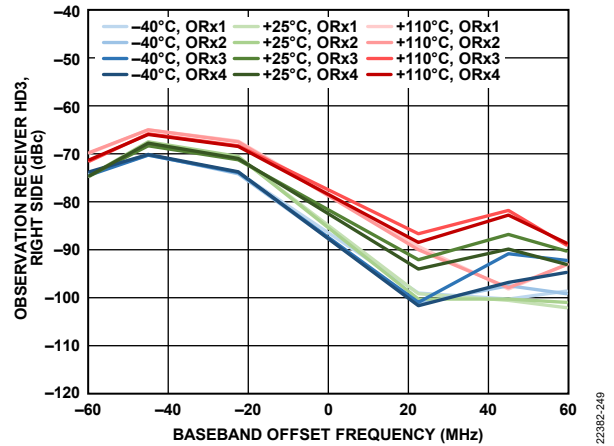

Figure 320. Observation Receiver HD3, Right Side vs. Baseband Offset Frequency, -10 dBFS Input Signal, Distortion Tone Measured Right of 0 Hz

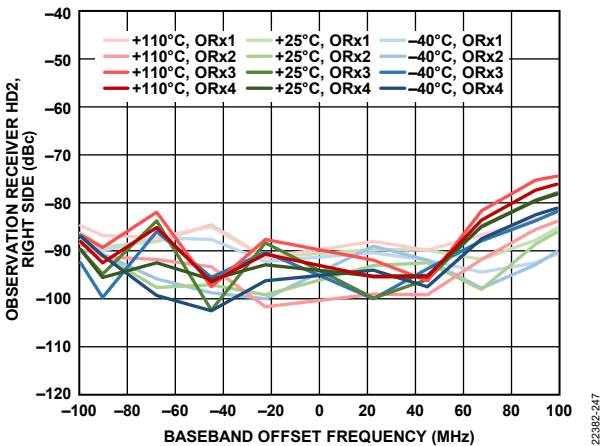

Figure 318. Observation Receiver HD2, Right Side vs. Baseband Offset Frequency, -10 dBFS Input Signal, Distortion Tone Measured Right of 0 Hz

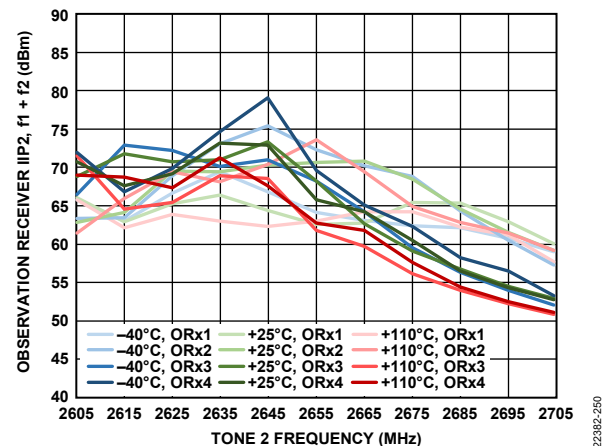

Figure 321. Observation Receiver IIP2,  $f_1 + f_2$  vs. Tone 2 Frequency, Both Tones at -13 dBFS,  $f_1 = f_2 + 2$  MHz

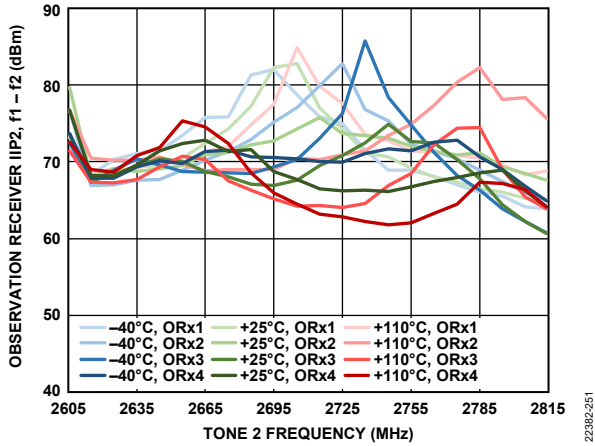

Figure 322. Observation Receiver IIP2,  $f_1 - f_2$  vs. Tone 2 Frequency, Both Tones at  $-13$  dBFS,  $f_1 = f_2 + 2$  MHz

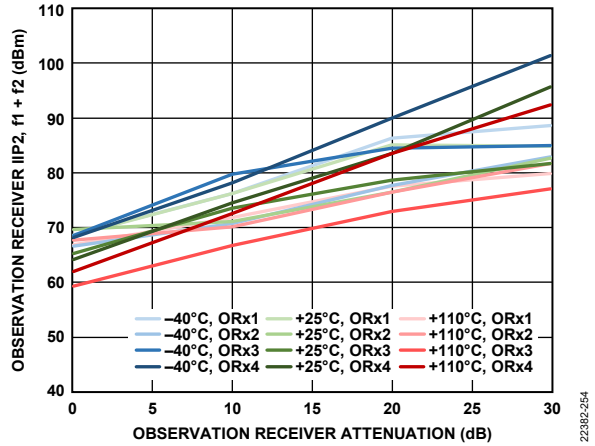

Figure 325. Observation Receiver IIP2,  $f_1 + f_2$  vs. Observation Receiver Attenuation, Both Tones at  $-13$  dBFS,  $f_1 = 102$  MHz,  $f_2 = 2$  MHz

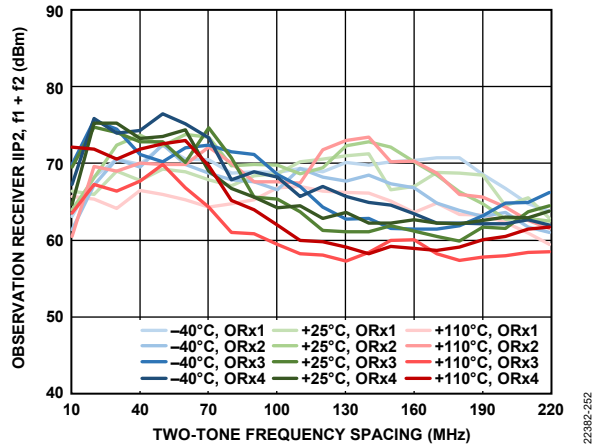

Figure 323. Observation Receiver IIP2,  $f_1 + f_2$  vs. Two-Tone Frequency Spacing, Both Tones at  $-13$  dBFS,  $f_2 = 2$  MHz

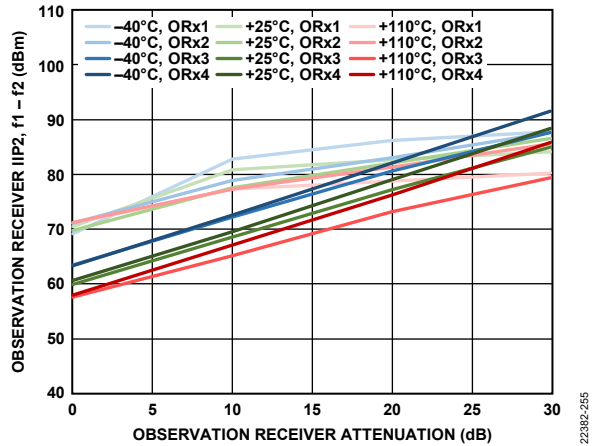

Figure 326. Observation Receiver IIP2,  $f_1 - f_2$  vs. Observation Receiver Attenuation, Both Tones at  $-13$  dBFS,  $f_1 = 102$  MHz,  $f_2 = 2$  MHz

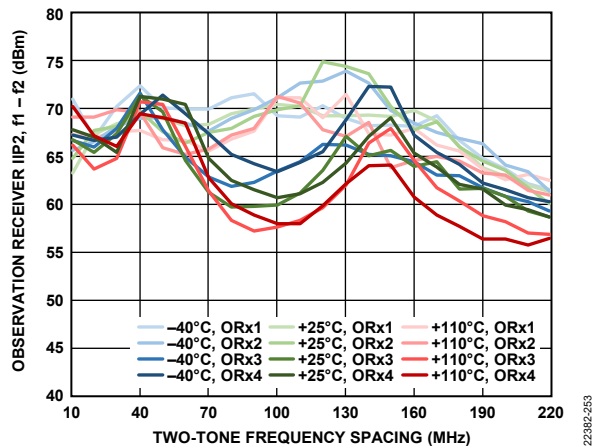

Figure 324. Observation Receiver IIP2,  $f_1 - f_2$  vs. Two-Tone Frequency Spacing, Both Tones at  $-13$  dBFS,  $f_2 = 2$  MHz

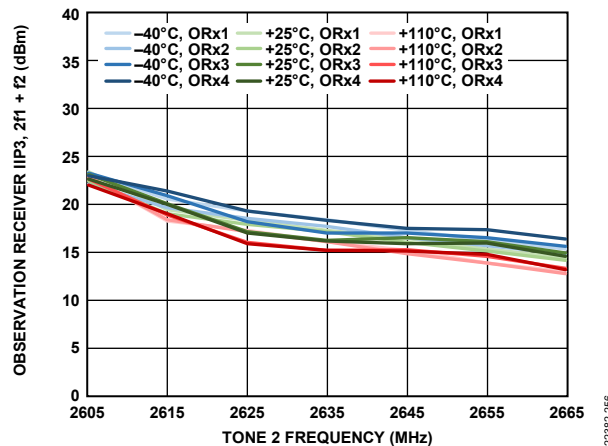
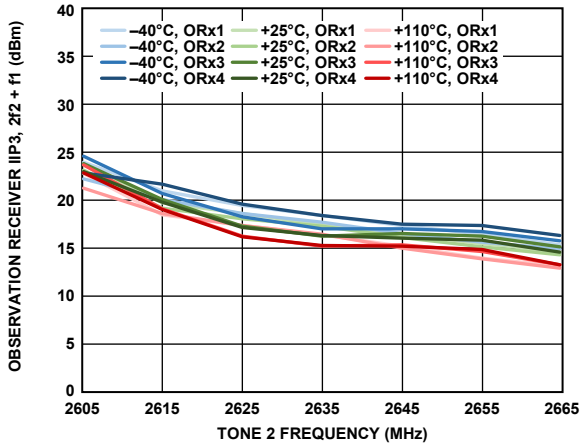
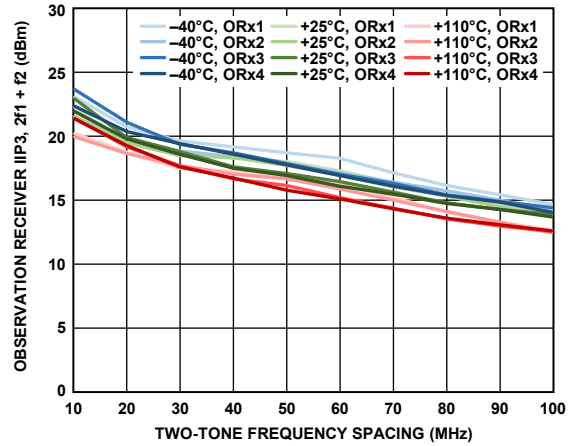

Figure 327. Observation Receiver IIP3,  $2f_1 + f_2$  vs. Tone 2 Frequency, Both Tones at  $-13$  dBFS,  $f_1 = f_2 + 2$  MHz



22382-257

Figure 328. Observation Receiver IIP3,  $2f_2 + f_1$  vs. Tone 2 Frequency, Both Tones at  $-13$  dBFS,  $f_1 = f_2 + 2$  MHz



22382-260

Figure 331. Observation Receiver IIP3,  $2f_1 + f_2$  vs. Two-Tone Frequency Spacing, Both Tones at  $-13$  dBFS,  $f_2 = 2$  MHz

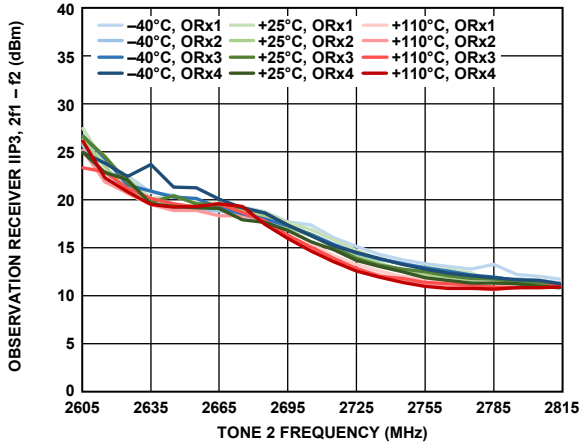

22382-258

Figure 329. Observation Receiver IIP3,  $2f_1 - f_2$  vs. Tone 2 Frequency, Both Tones at  $-13$  dBFS,  $f_1 = f_2 + 2$  MHz

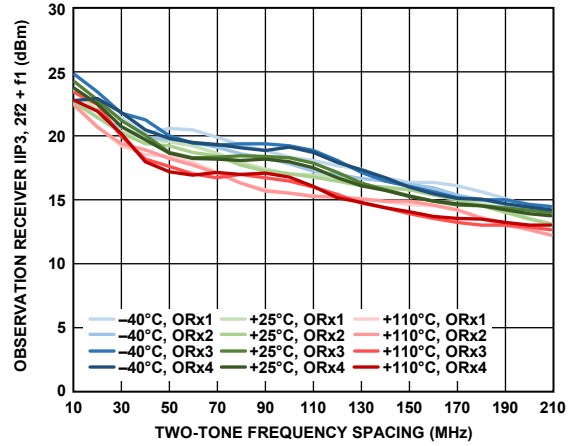

22382-261

Figure 332. Observation Receiver IIP3,  $2f_2 + f_1$  vs. Two-Tone Frequency Spacing, Both Tones at  $-13$  dBFS,  $f_2 = 2$  MHz

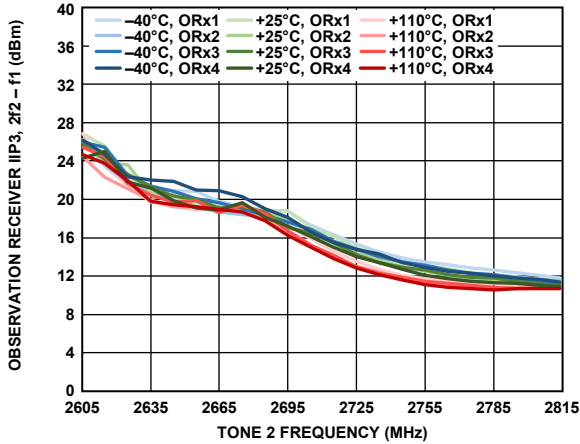

22382-259

Figure 330. Observation Receiver IIP3,  $2f_2 - f_1$  vs. Tone 2 Frequency, Both Tones at  $-13$  dBFS,  $f_1 = f_2 + 2$  MHz

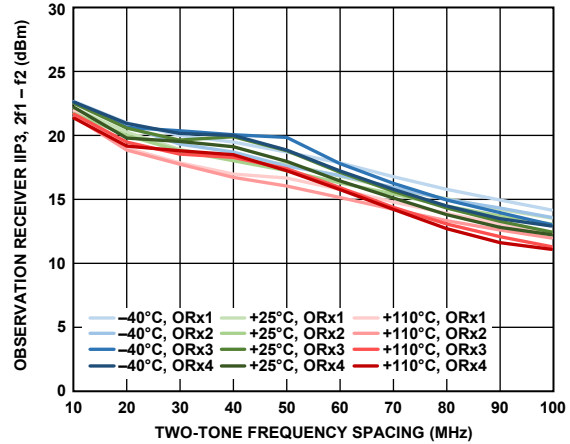

22382-262

Figure 333. Observation Receiver IIP3,  $2f_1 - f_2$  vs. Two-Tone Frequency Spacing, Both Tones at  $-13$  dBFS,  $f_2 = 2$  MHz



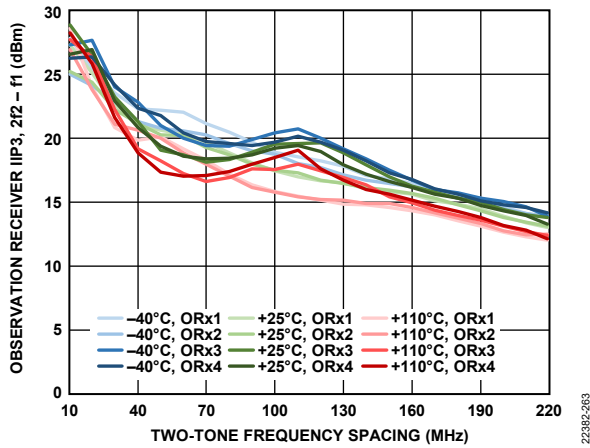

Figure 334. Observation Receiver IIP3,  $2f_2 - f_1$  vs. Two-Tone Frequency Spacing, Both Tones at  $-13$  dBFS,  $f_2 = 2$  MHz

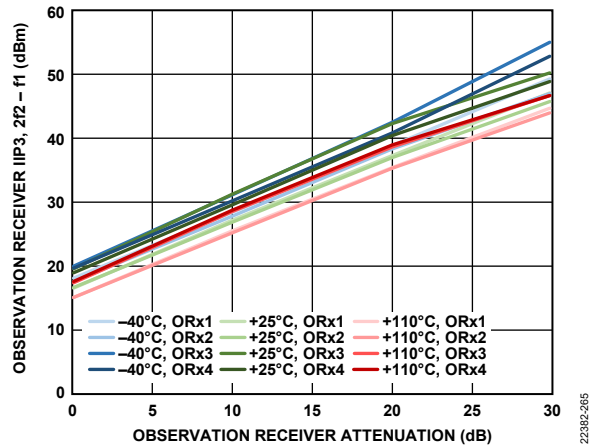

Figure 336. Observation Receiver IIP3,  $2f_2 - f_1$  vs. Observation Receiver Attenuation, Both Tones at  $-13$  dBFS,  $f_1 = 122$  MHz,  $f_2 = 2$  MHz

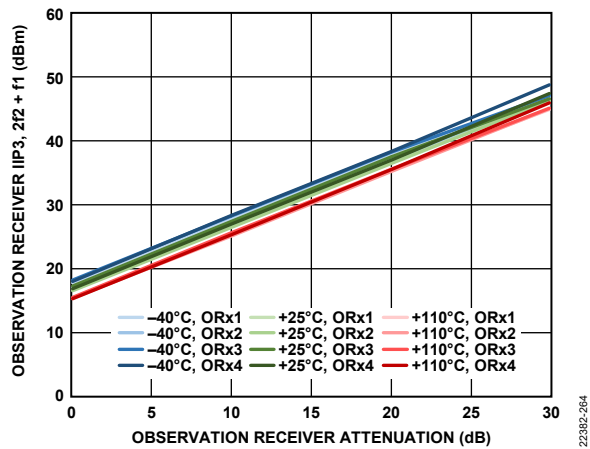

Figure 335. Observation Receiver IIP3,  $2f_2 + f_1$  vs. Observation Receiver Attenuation, Both Tones at  $-13$  dBFS,  $f_1 = 122$  MHz,  $f_2 = 2$  MHz

**3800 MHZ BAND**

Device configuration profile: receiver = 200 MHz bandwidth, I/Q rate = 245.76 MHz, transmitter = 200 MHz large signal bandwidth plus 450 MHz synthesis bandwidth, I/Q rate = 491.52 MHz, observation receiver (OR<sub>x</sub>) = 450 MHz bandwidth, I/Q rate = 491.52 MHz, device clock = 245.76 MHz, unless otherwise noted. The temperature settings refer to the die temperature. All LO frequencies set to 3800 MHz, unless otherwise noted.

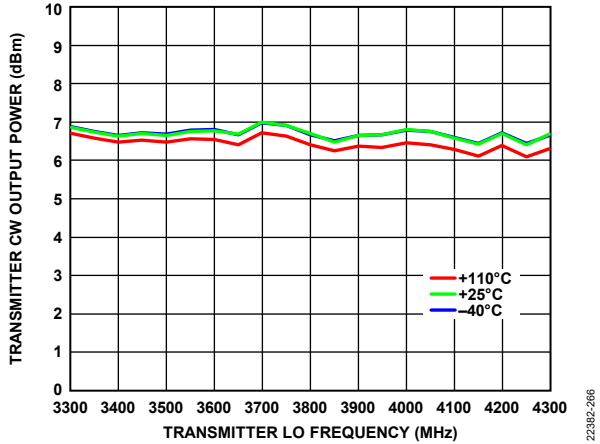

Figure 337. Transmitter Continuous Wave Output Power vs. Transmitter LO Frequency, 10 MHz Offset, 0 dB Attenuation

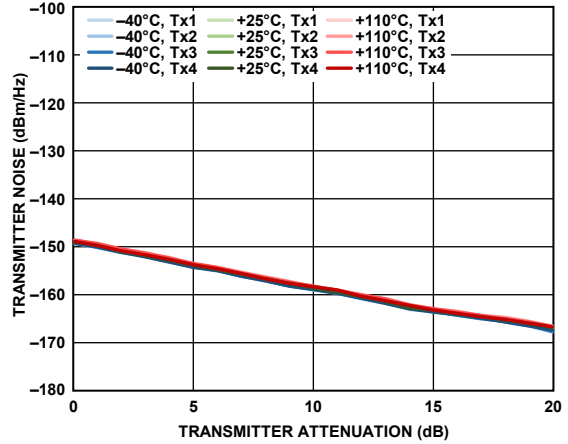

Figure 340. Transmitter Noise vs. Transmitter Attenuation, 10 MHz Offset Frequency

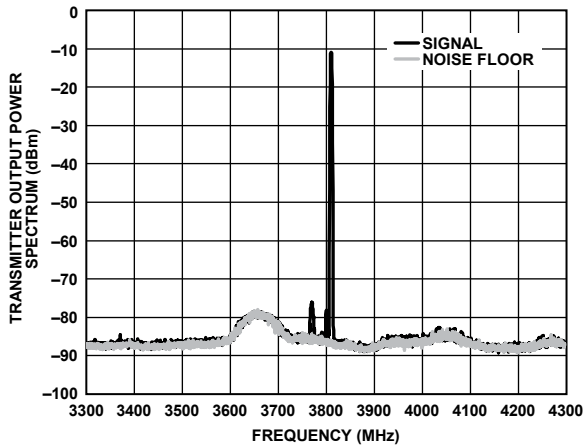

Figure 338. Transmitter Output Power Spectrum, Tx1, 5 MHz LTE, 10 MHz Offset, -10 dBFS RMS, 1 MHz Resolution Bandwidth, T<sub>j</sub> = 25°C (Step at 3600 MHz Due to Spectrum Analyzer)

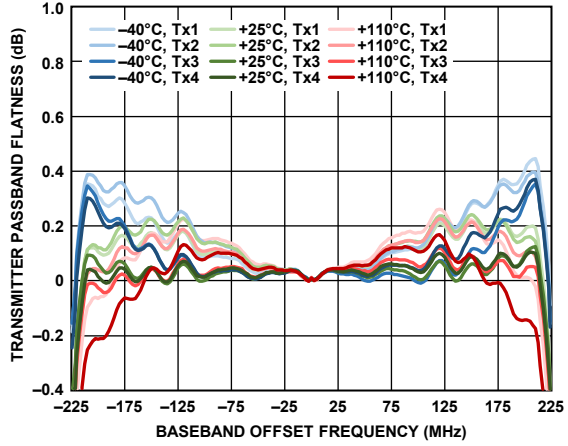

Figure 341. Transmitter Pass Band Flatness vs. Baseband Offset Frequency

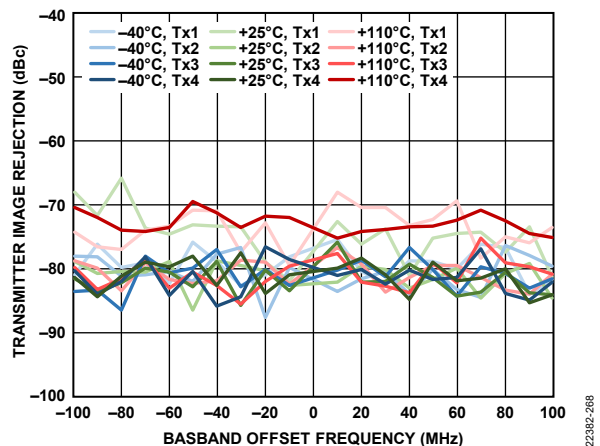

Figure 339. Transmitter Image Rejection Across Large Signal Bandwidth vs. Baseband Offset Frequency

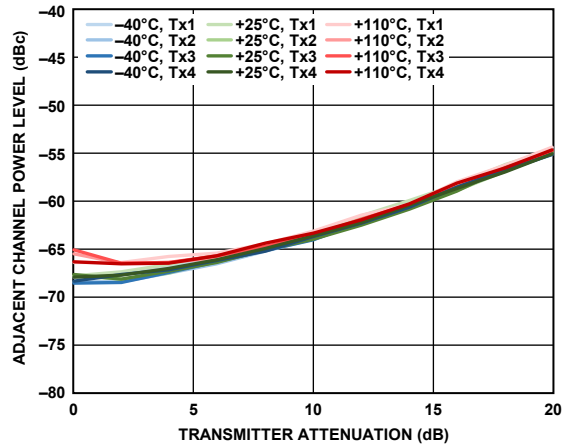

Figure 342. Adjacent Channel Power Level vs. Transmitter Attenuation, -10 MHz Baseband Offset, 20 MHz LTE, PAR = 12 dB

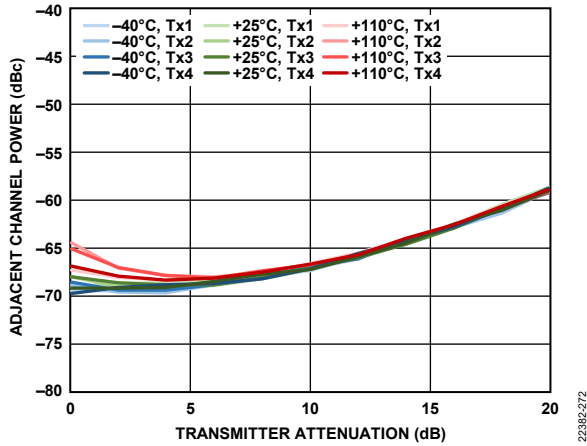

Figure 343. Adjacent Channel Power Level vs. Transmitter Attenuation, 90 MHz Baseband Offset, 20 MHz LTE, PAR = 12 dB

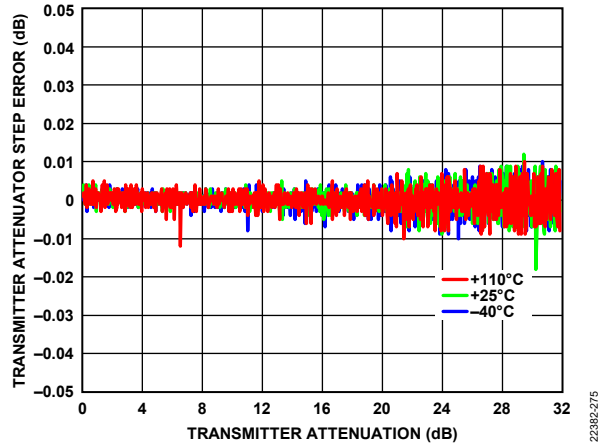

Figure 346. Transmitter Attenuator Step Error vs. Transmitter Attenuation, 10 MHz Offset

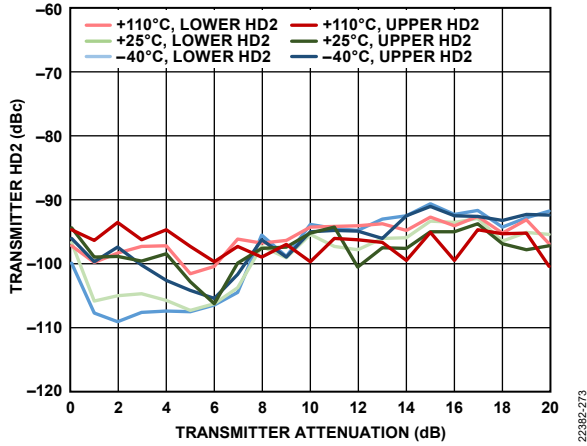

Figure 344. Transmitter Second Harmonic Distortion (HD2) vs. Transmitter Attenuation, 10 MHz Offset

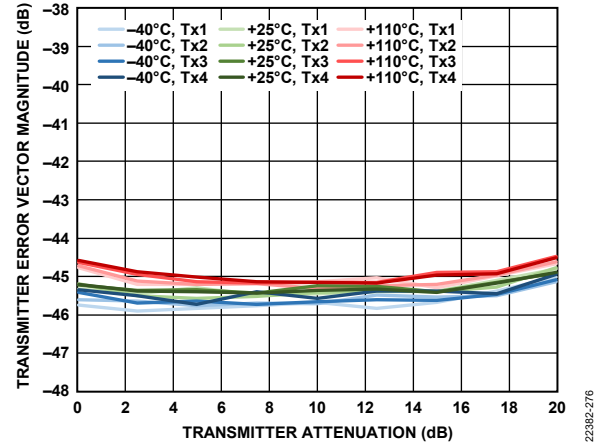

Figure 347. Transmitter Error Vector Magnitude vs. Transmitter Attenuation, 20 MHz LTE Signal Centered at LO Frequency, Sample Rate = 491.52 MSPS, Loop Filter Bandwidth = 200 kHz, Loop Filter Phase Margin = 60°

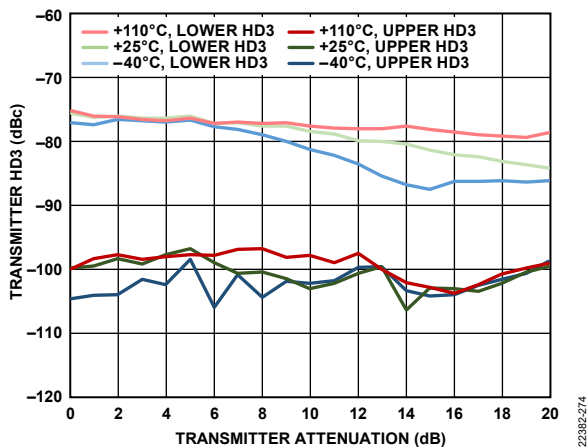

Figure 345. Transmitter Third Harmonic Distortion (HD3) vs. Transmitter Attenuation, 10 MHz Offset

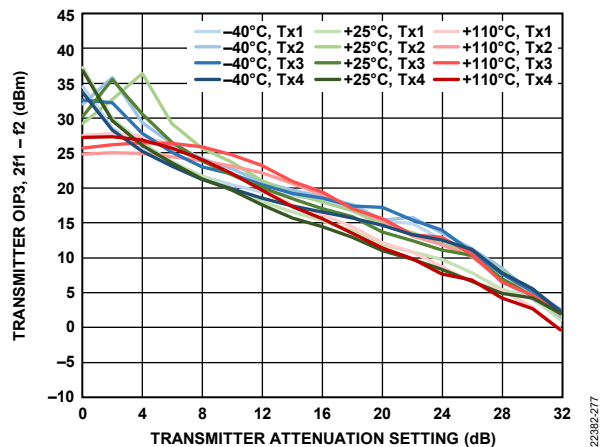

Figure 348. Transmitter OIP3, 2f1 - f2 vs. Transmitter Attenuation, 15 dB Digital Back Off per Tone, f1 = 50.5 MHz, f2 = 55.5 MHz

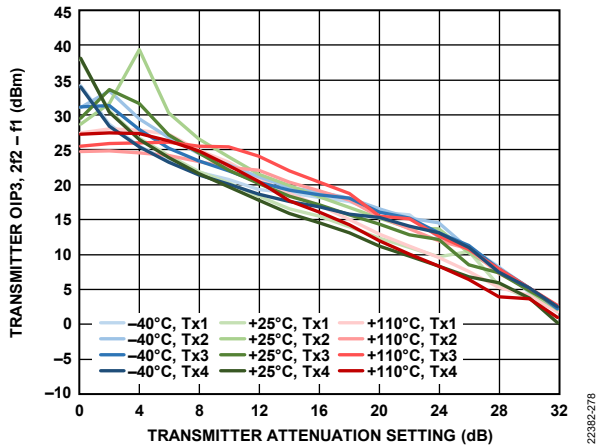

Figure 349. Transmitter OIP3, 2f2 – f1 vs. Transmitter Attenuation, 15 dB Digital Back Off per Tone, f1 = 50.5 MHz, f2 = 55.5 MHz

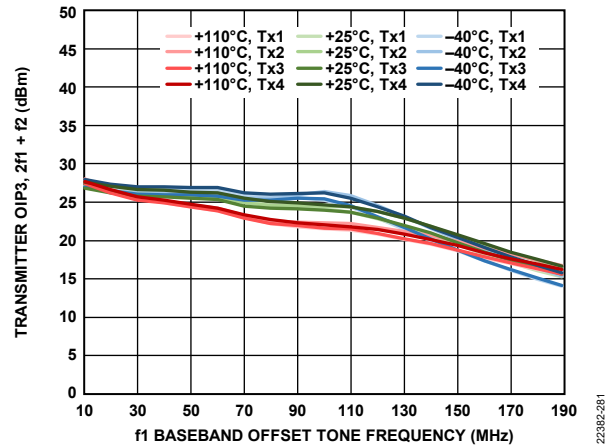

Figure 352. Transmitter OIP3, 2f1 + f2 vs. f1 Baseband Offset Tone Frequency, f2 = f1 + 5 MHz, 15 dB Digital Back Off per Tone

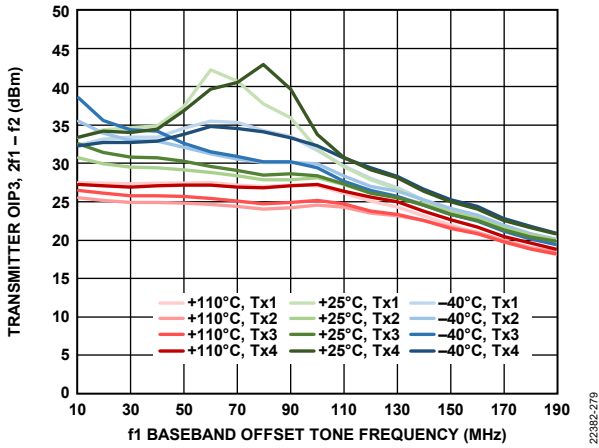

Figure 350. Transmitter OIP3, 2f1 – f2 vs. f1 Baseband Offset Tone Frequency, f2 = f1 + 5 MHz, 15 dB Digital Back Off per Tone

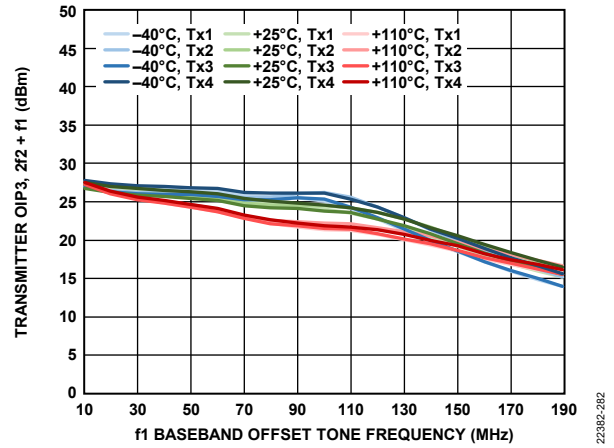

Figure 353. Transmitter OIP3, 2f2 + f1 vs. f1 Baseband Offset Tone Frequency, f2 = f1 + 5 MHz, 15 dB Digital Back Off per Tone

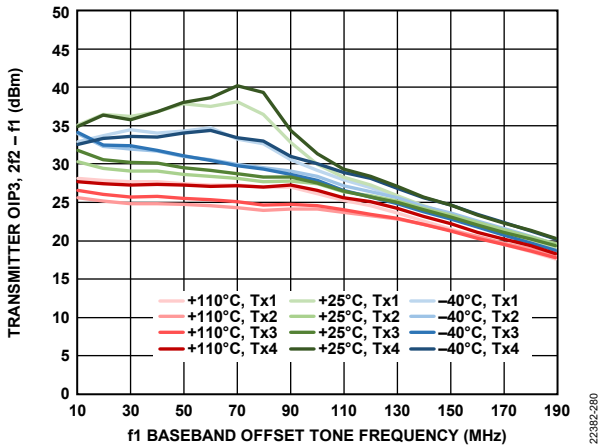

Figure 351. Transmitter OIP3, 2f2 – f1 vs. f1 Baseband Offset Tone Frequency, f2 = f1 + 5 MHz, 15 dB Digital Back Off per Tone

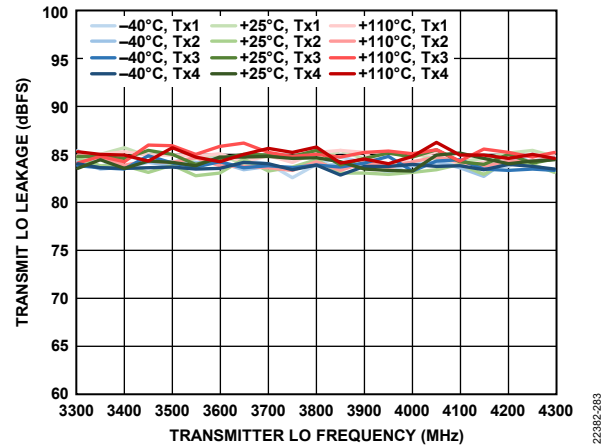

Figure 354. Transmitter LO Leakage vs. Transmitter LO Frequency

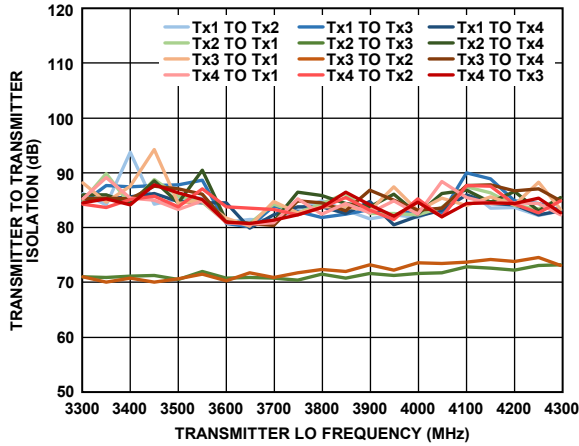

Figure 355. Transmitter to Transmitter Isolation vs. Transmitter LO Frequency

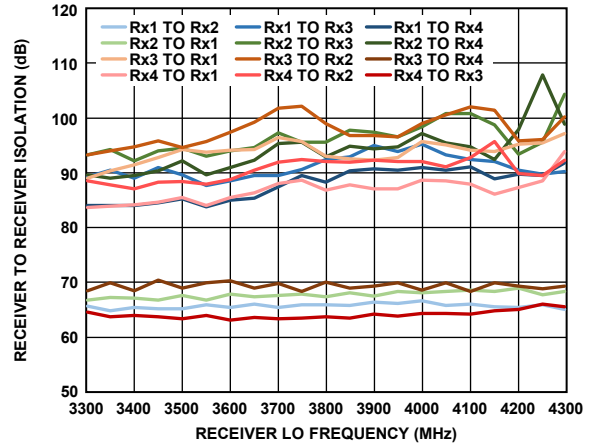

Figure 358. Receiver to Receiver Isolation vs. Receiver LO Frequency

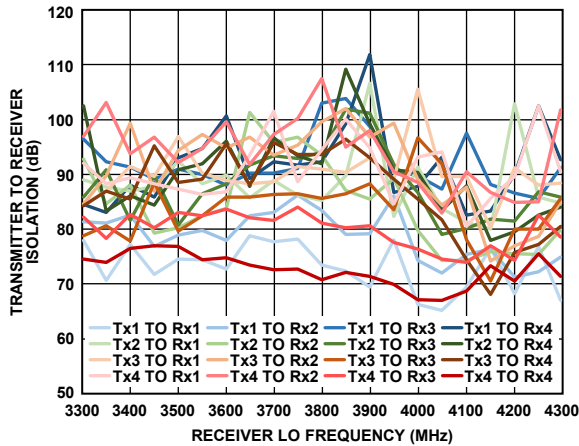

Figure 356. Transmitter to Receiver Isolation vs. Receiver LO Frequency

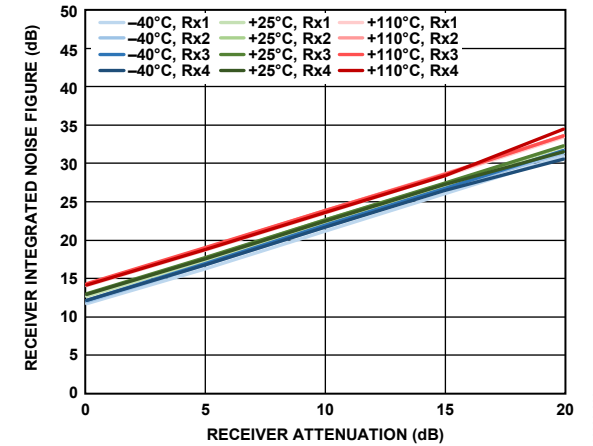

Figure 359. Receiver Integrated Noise Figure vs. Receiver Attenuation, 200 MHz Bandwidth, Sample Rate = 245.76 MSPS, Integration Bandwidth = 500 kHz to 100 MHz

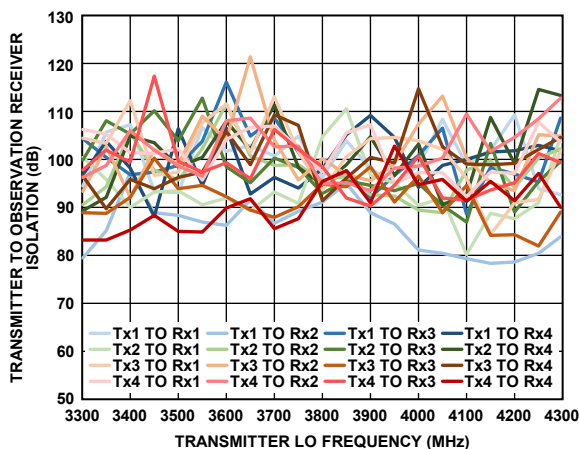

Figure 357. Transmitter to Observation Receiver Isolation vs. Transmitter LO Frequency

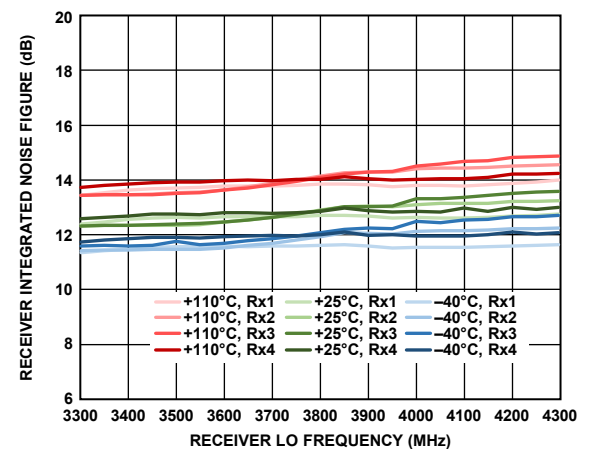

Figure 360. Receiver Integrated Noise Figure vs. Receiver LO Frequency, 200 MHz Bandwidth, Sample Rate = 245.76 MSPS, Integration Bandwidth = 500 kHz to 100 MHz

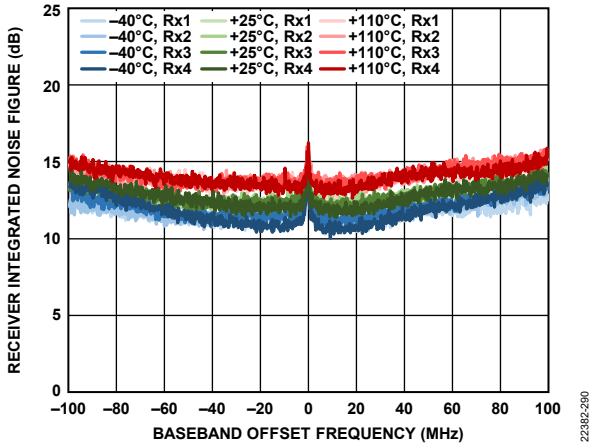

Figure 361. Receiver Integrated Noise Figure vs. Baseband Offset Frequency, 200 MHz Bandwidth, Sample Rate = 245.76 MSPS, Integrated in 200 kHz Steps

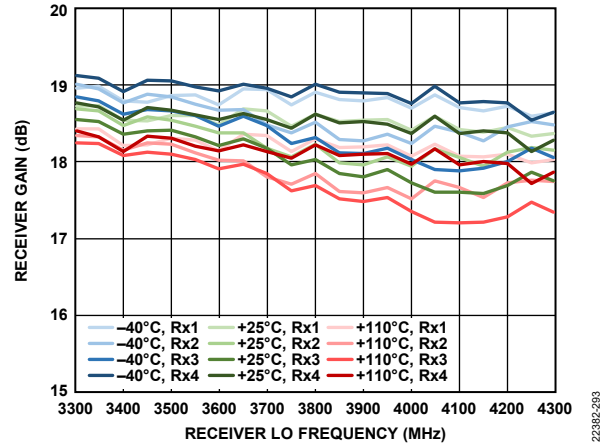

Figure 364. Receiver Gain vs. Receiver LO Frequency, 200 MHz Bandwidth, Sample Rate = 245.76 MSPS

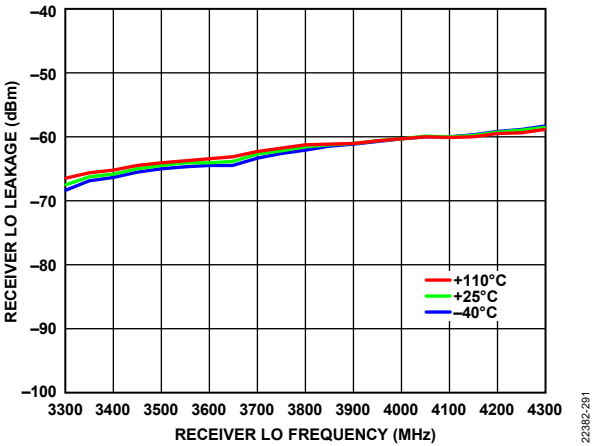

Figure 362. Receiver LO Leakage vs. Receiver LO Frequency, Attenuation = 0 dB, Sample Rate = 245.76 MSPS

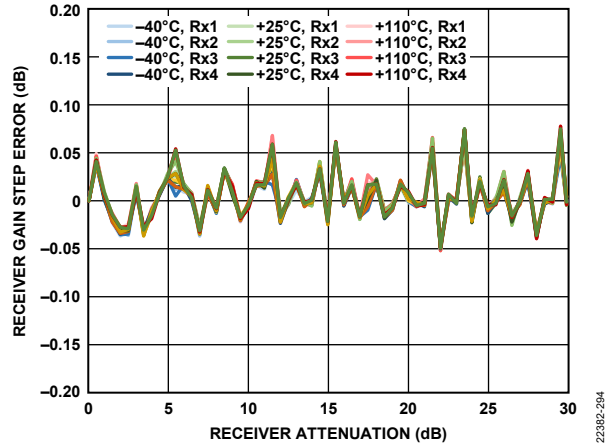

Figure 365. Receiver Gain Step Error vs. Receiver Attenuation, 20 MHz Offset, -5 dBFS Input Signal

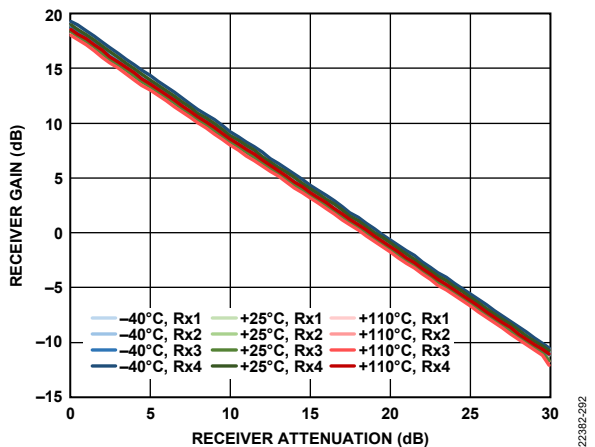

Figure 363. Receiver Gain vs. Receiver Attenuation, 20 MHz Offset, 200 MHz Bandwidth, Sample Rate = 245.76 MSPS

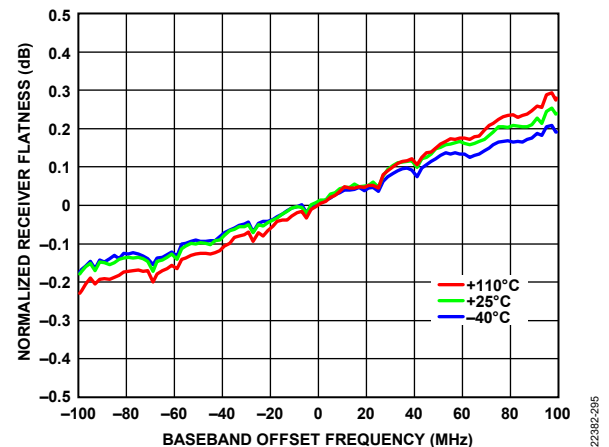

Figure 366. Normalized Receiver Flatness vs. Baseband Offset Frequency, -5 dBFS Input Signal

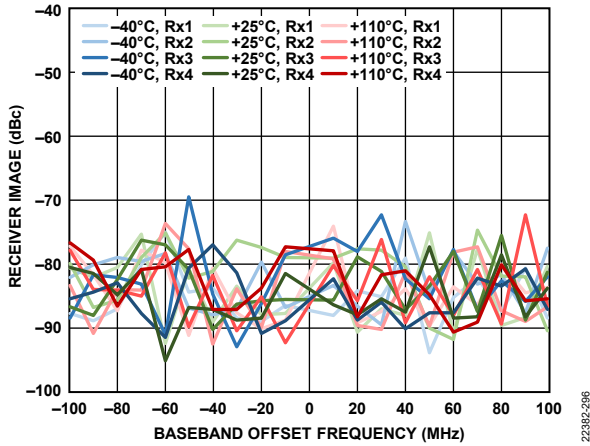

Figure 367. Receiver Image vs. Baseband Offset Frequency, Tracking Calibration Active, Sample Rate = 245.76 MSPS

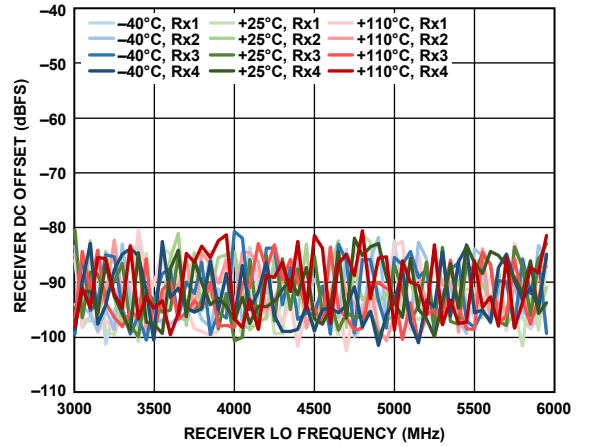

Figure 370. Receiver DC Offset vs. Receiver LO Frequency, Attenuation = 0 dB, Sample Rate = 245.76 MSPS

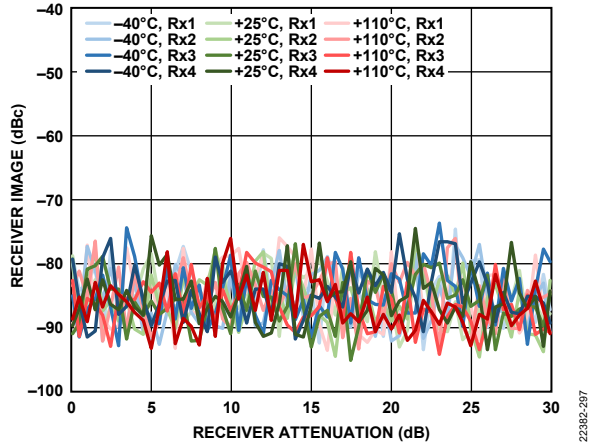

Figure 368. Receiver Image vs. Receiver Attenuation, 20 MHz Offset, Tracking Calibration Active, Sample Rate = 245.76 MSPS

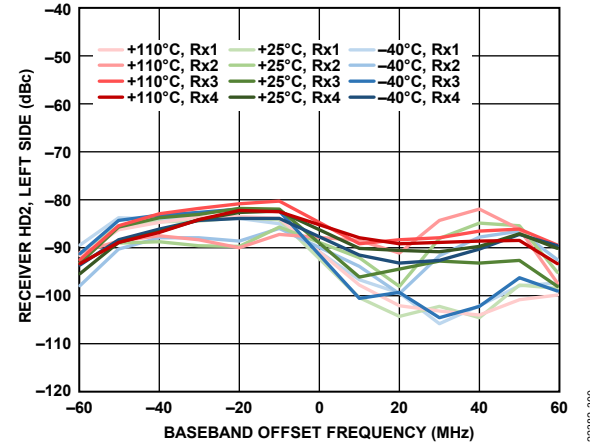

Figure 371. Receiver HD2, Left Side vs. Baseband Offset Frequency, -5 dBFS Input Signal, Distortion Tone Measured Left of 0 Hz (HD2 Canceller Not Enabled)

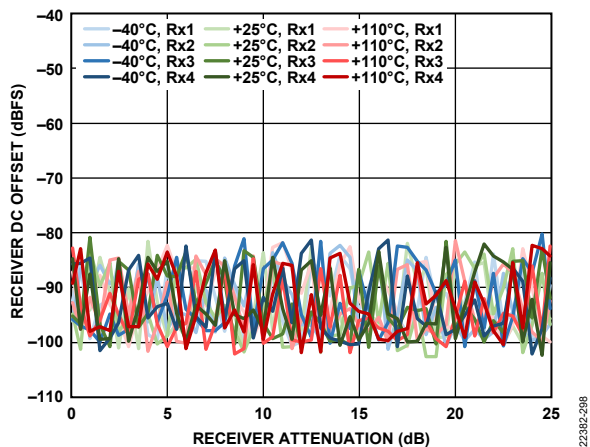

Figure 369. Receiver DC Offset vs. Receiver Attenuation, 20 MHz Offset, -5 dBFS Input Signal, Sample Rate = 245.76 MSPS

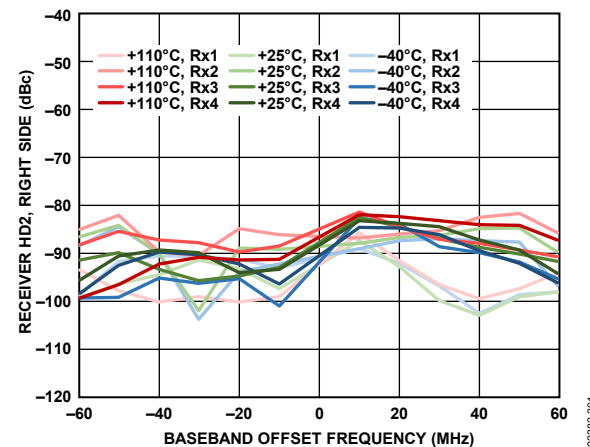

Figure 372. Receiver HD2, Right Side vs. Baseband Offset Frequency, -5 dBFS Input Signal, Distortion Tone Measured Right of 0 Hz (HD2 Canceller Not Enabled)

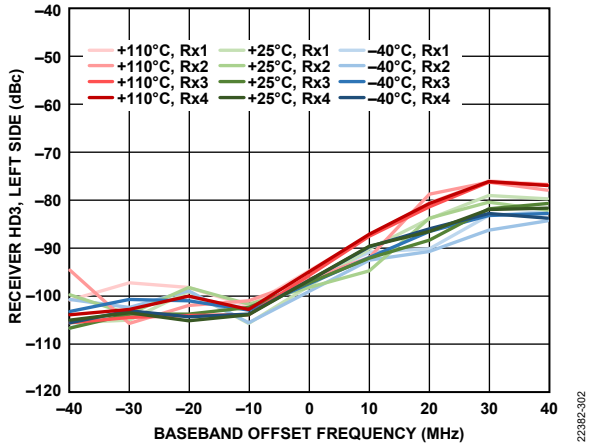

Figure 373. Receiver HD3, Left Side vs. Baseband Offset Frequency, -5 dBFS Input Signal, Distortion Tone Measured Left of 0 Hz

22382-302

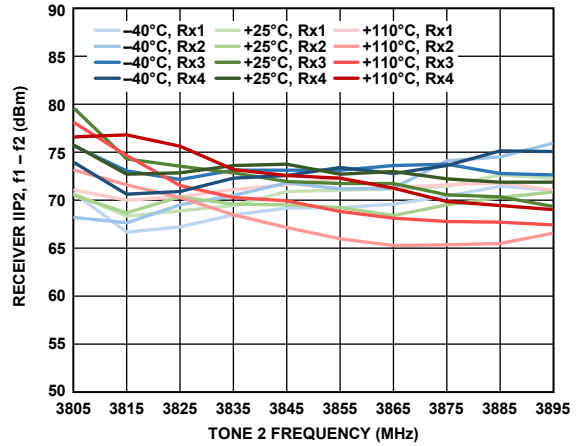

Figure 376. Receiver IIP2,  $f_1 - f_2$  vs. Tone 2 Frequency, Both Tones at -11 dBFS,  $f_1 = f_2 + 2$  MHz

22382-305

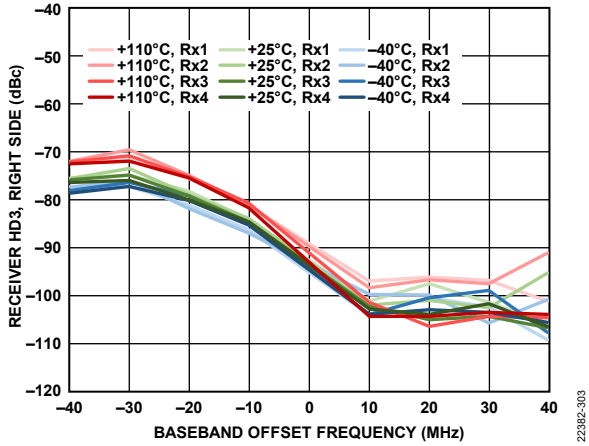

Figure 374. Receiver HD3, Right Side vs. Baseband Offset Frequency, -5 dBFS Input Signal, Distortion Tone Measured Right of 0 Hz

22382-303

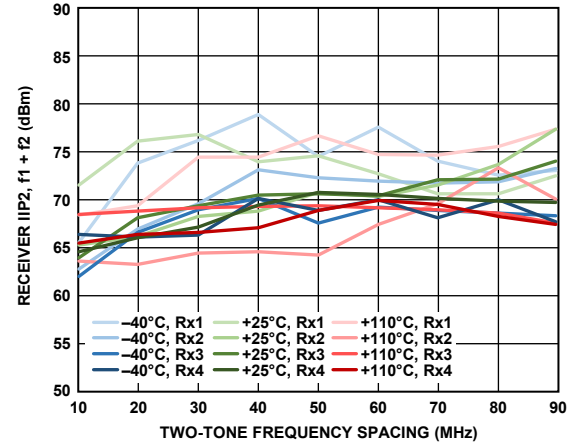

Figure 377. Receiver IIP2,  $f_1 + f_2$  vs. Two-Tone Frequency Spacing, Both Tones at -11 dBFS,  $f_2 = 2$  MHz

22382-306

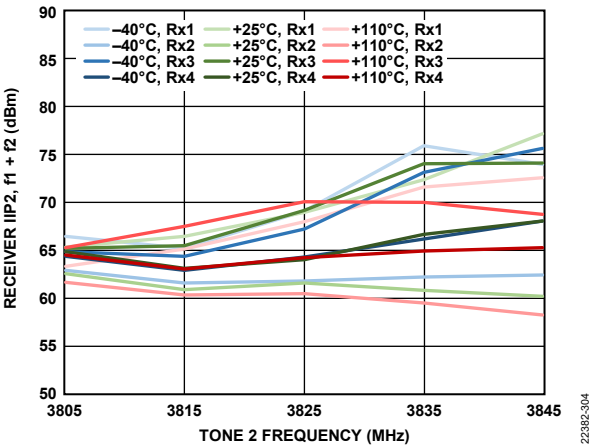

Figure 375. Receiver IIP2,  $f_1 + f_2$  vs. Tone 2 Frequency, Both Tones at -11 dBFS,  $f_1 = f_2 + 2$  MHz

22382-304

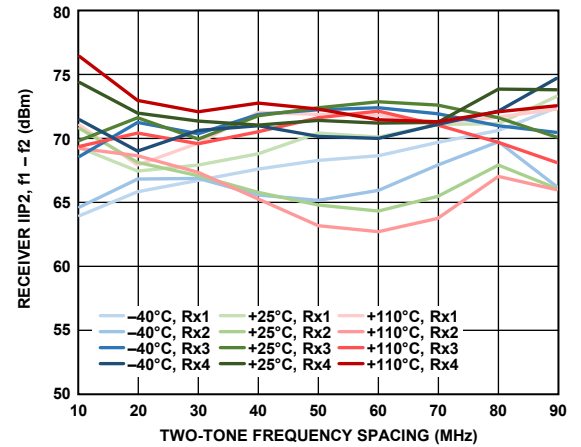

Figure 378. Receiver IIP2,  $f_1 - f_2$  vs. Two-Tone Frequency Spacing, Both Tones at -11 dBFS,  $f_2 = 2$  MHz

22382-307



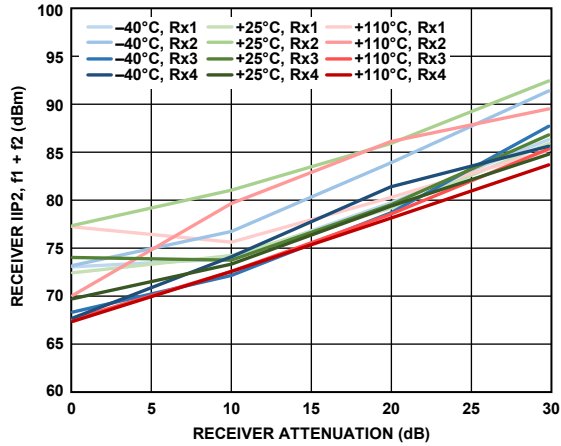

Figure 379. Receiver IIP2,  $f_1 + f_2$  vs. Receiver Attenuation, Both Tones at  $-11$  dBFS,  $f_1 = 92$  MHz,  $f_2 = 2$  MHz

22382-308

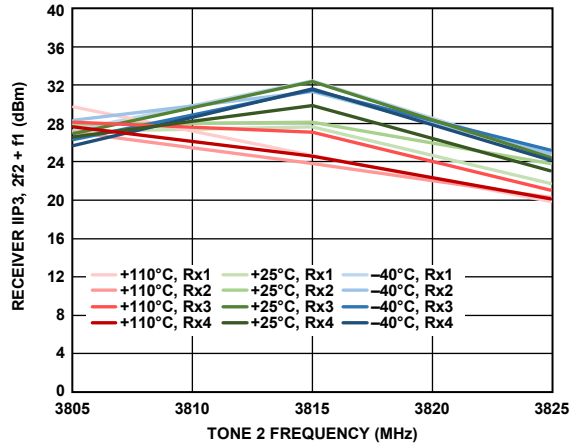

Figure 382. Receiver IIP3,  $2f_2 + f_1$  vs. Tone 2 Frequency, Both Tones at  $-11$  dBFS,  $f_1 = f_2 + 2$  MHz

22382-311

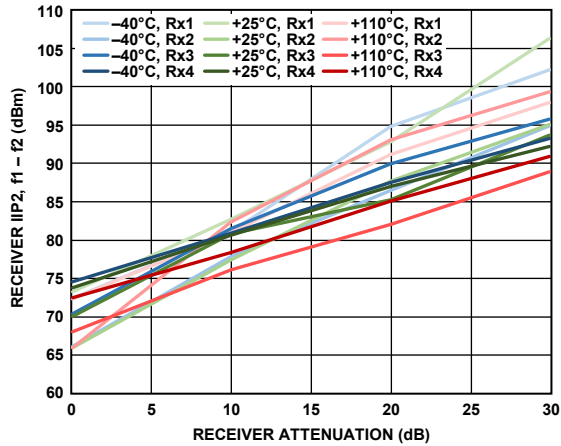

Figure 380. Receiver IIP2,  $f_1 - f_2$  vs. Receiver Attenuation, Both Tones at  $-11$  dBFS,  $f_1 = 92$  MHz,  $f_2 = 2$  MHz

22382-309

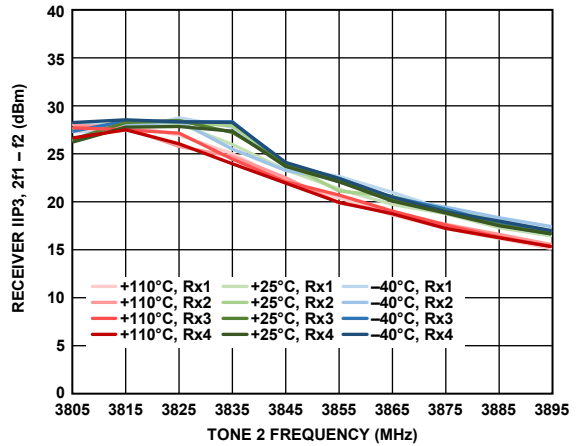

Figure 383. Receiver IIP3,  $2f_1 - f_2$  vs. Tone 2 Frequency, Both Tones at  $-11$  dBFS,  $f_1 = f_2 + 2$  MHz

22382-312

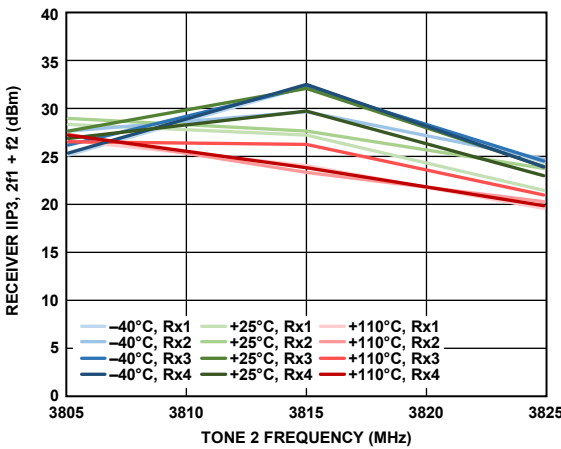

Figure 381. Receiver IIP3,  $2f_1 + f_2$  vs. Tone 2 Frequency, Both Tones at  $-11$  dBFS,  $f_1 = f_2 + 2$  MHz

22382-310

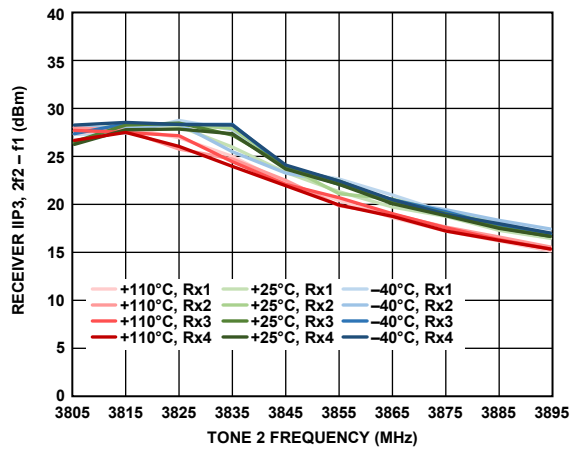

Figure 384. Receiver IIP3,  $2f_2 - f_1$  vs. Tone 2 Frequency, Both Tones at  $-11$  dBFS,  $f_1 = f_2 + 2$  MHz

22382-313

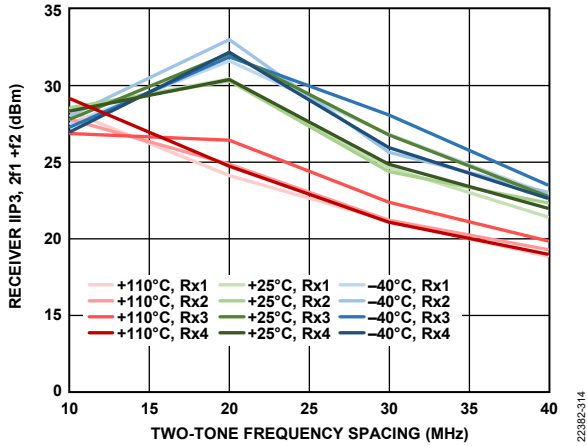

Figure 385. Receiver IIP3,  $2f_1 + f_2$  vs. Two-Tone Frequency Spacing, Both Tones at  $-11$  dBFS,  $f_2 = 2$  MHz

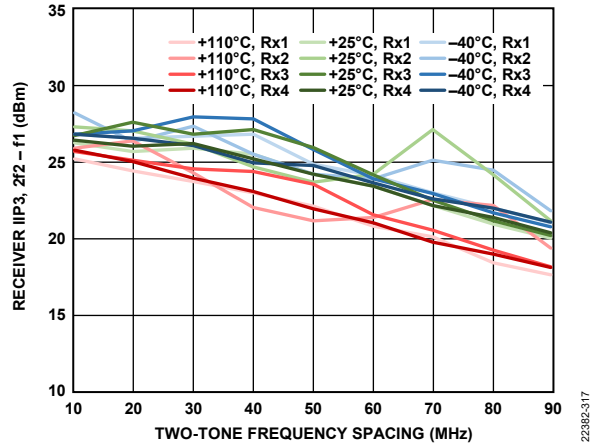

Figure 388. Receiver IIP3,  $2f_2 - f_1$  vs. Two-Tone Frequency Spacing, Both Tones at  $-11$  dBFS,  $f_2 = 2$  MHz

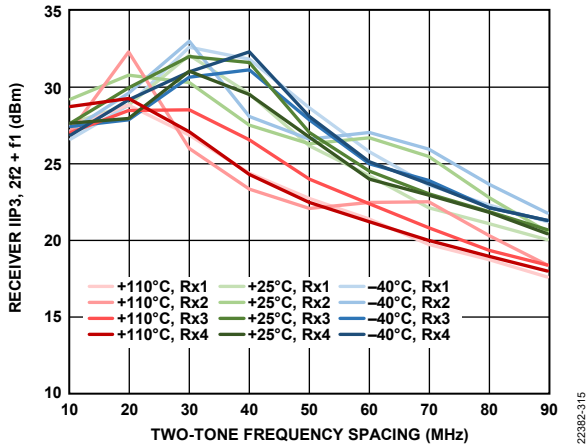

Figure 386. Receiver IIP3,  $2f_2 + f_1$  vs. Two-Tone Frequency Spacing, Both Tones at  $-11$  dBFS,  $f_2 = 2$  MHz

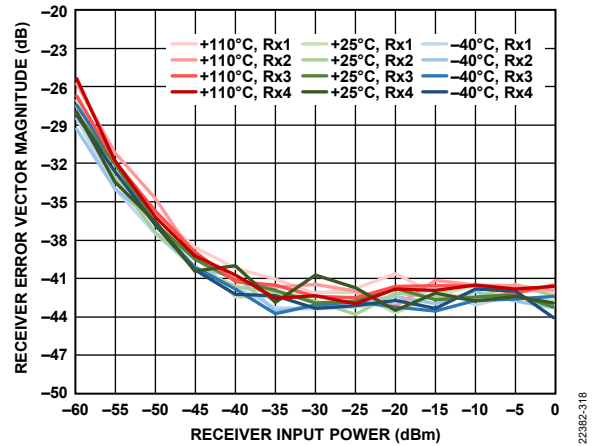

Figure 389. Receiver Error Vector Magnitude vs. Receiver Input Power, 20 MHz LTE Signal Centered at LO Frequency, Sample Rate = 245.76 MSPS, Loop Filter Bandwidth = 200 kHz, Loop Filter Phase Margin =  $60^\circ$

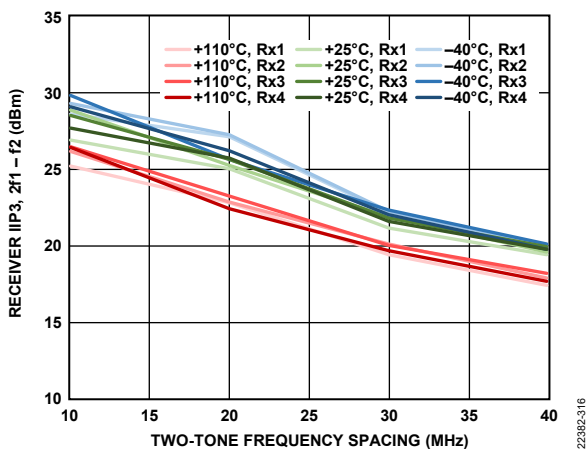

Figure 387. Receiver IIP3,  $2f_1 - f_2$  vs. Two-Tone Frequency Spacing, Both Tones at  $-11$  dBFS,  $f_2 = 2$  MHz

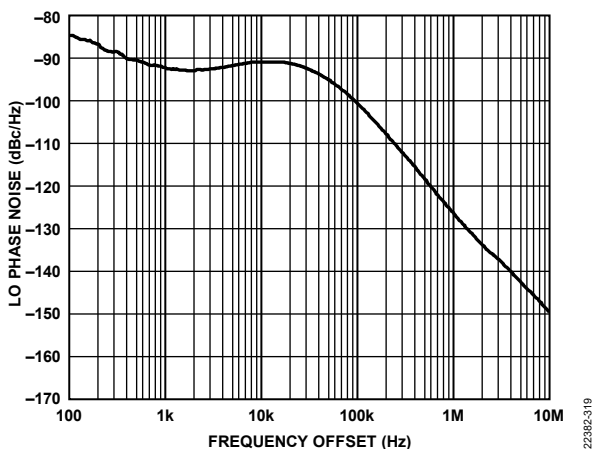

Figure 390. LO Phase Noise vs. Frequency Offset, Loop Bandwidth = 75 kHz, Phase Margin =  $85^\circ$

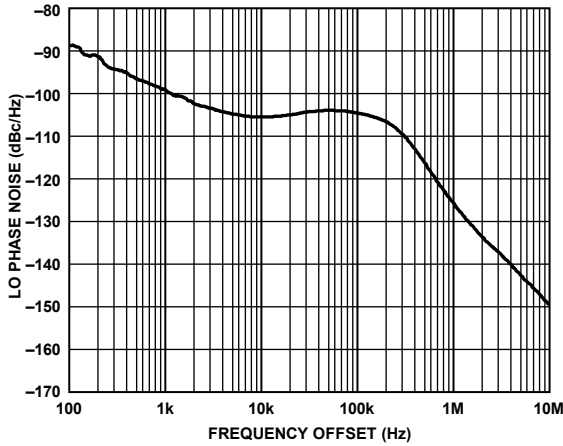

Figure 391. LO Phase Noise vs. Frequency Offset, Loop Bandwidth = 200 kHz, Phase Margin = 60°

223862-320

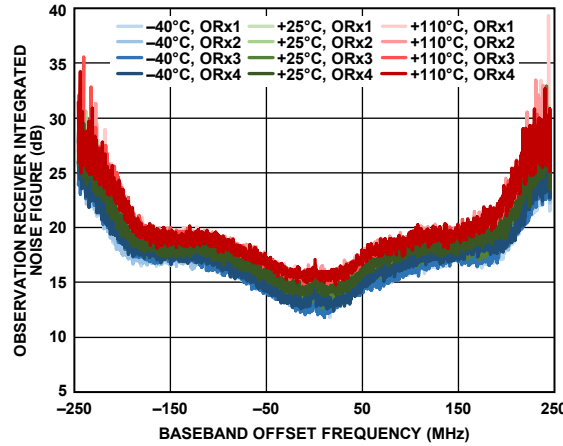

Figure 394. Observation Receiver Integrated Noise Figure vs. Baseband Offset Frequency, 450 MHz Bandwidth, Sample Rate = 491.52 MSPS, Integrated in 200 kHz Steps

223862-323

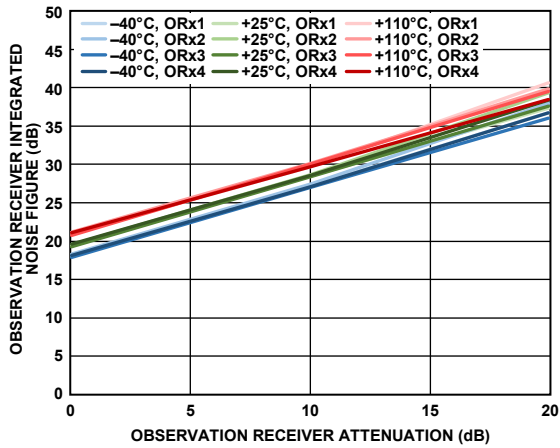

Figure 392. Observation Receiver Integrated Noise Figure vs. Observation Receiver Attenuation, 450 MHz Bandwidth, Sample Rate = 491.52 MSPS, Integration Bandwidth = 500 kHz to 245.76 MHz

223862-321

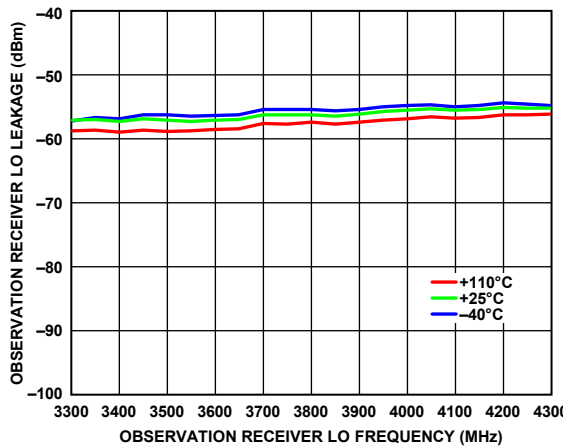

Figure 395. Observation Receiver LO Leakage vs. Observation Receiver LO Frequency, Attenuation = 0 dB, Sample Rate = 491.52 MSPS

223862-324

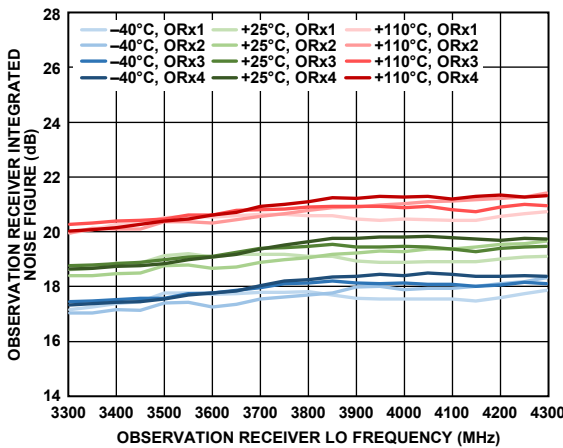

Figure 393. Observation Receiver Integrated Noise Figure vs. Observation Receiver LO Frequency, 450 MHz Bandwidth, Sample Rate = 491.52 MSPS, Integration Bandwidth = 500 kHz to 245.76 MHz

223862-322

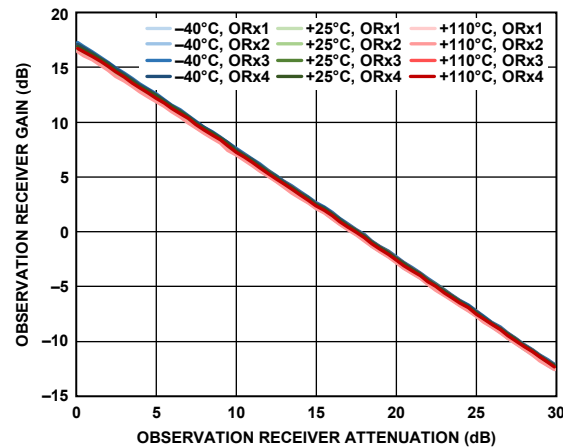

Figure 396. Observation Receiver Gain vs. Observation Receiver Attenuation, 45 MHz Offset, 450 MHz Bandwidth, Sample Rate = 491.52 MSPS

223862-325

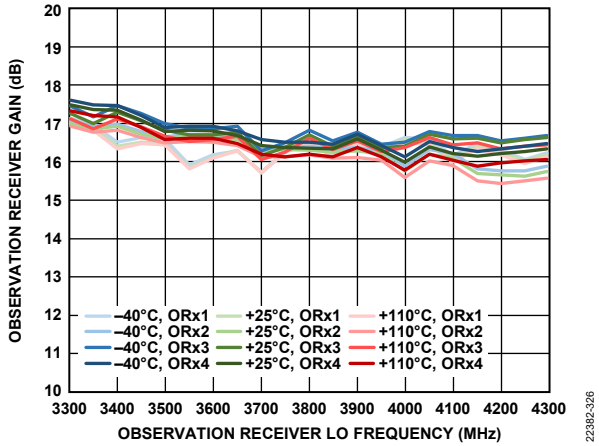

Figure 397. Observation Receiver Gain vs. Observation Receiver LO Frequency, 450 MHz Bandwidth, Sample Rate = 491.52 MSPS

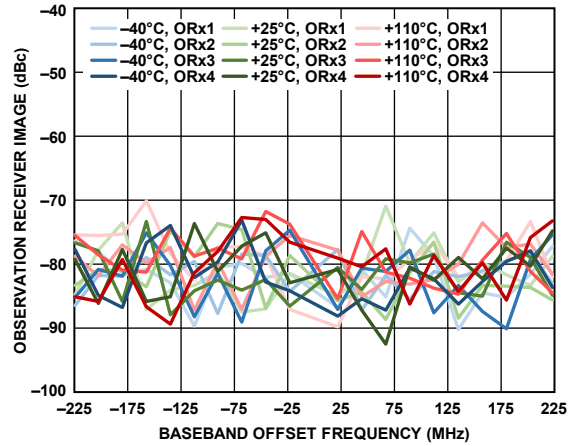

Figure 400. Observation Receiver Image vs. Baseband Offset Frequency, Tracking Calibration Active, Sample Rate = 491.52 MSPS

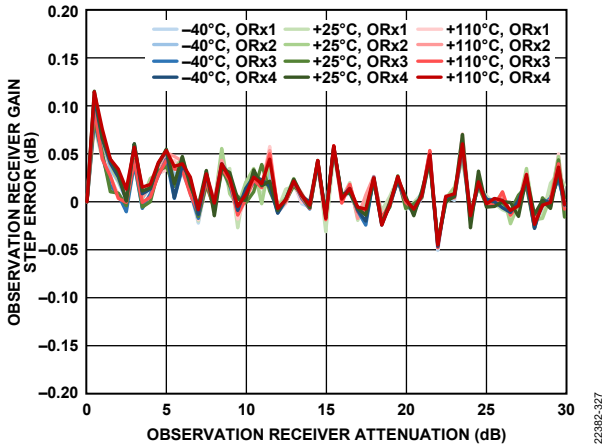

Figure 398. Observation Receiver Gain Step Error vs. Observation Receiver Attenuation, 45 MHz Offset, -10 dBFS Input Signal

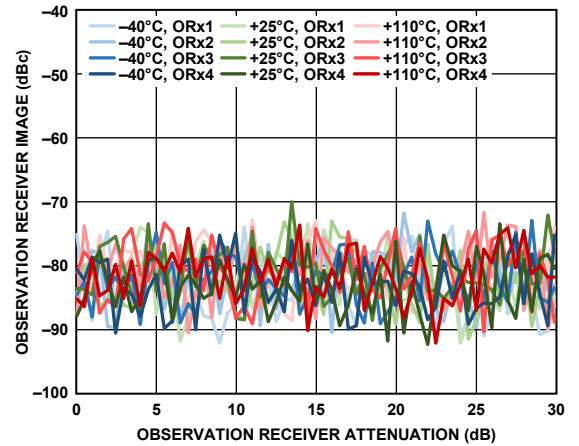

Figure 401. Observation Receiver Image vs. Observation Receiver Attenuation, 45 MHz Offset, Tracking Calibration Active, Sample Rate = 491.52 MSPS

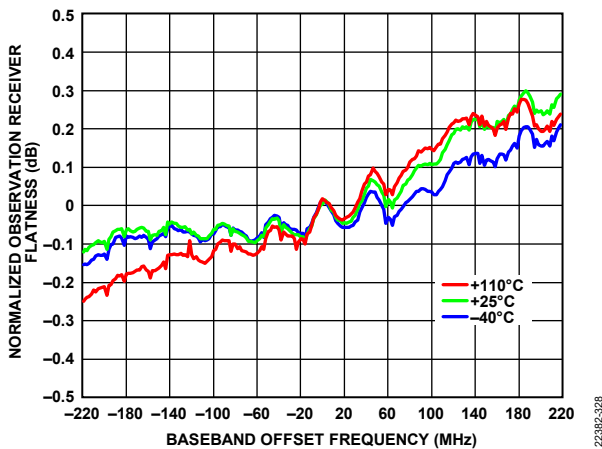

Figure 399. Normalized Observation Receiver Flatness vs. Baseband Offset Frequency, -10 dBFS Input Signal

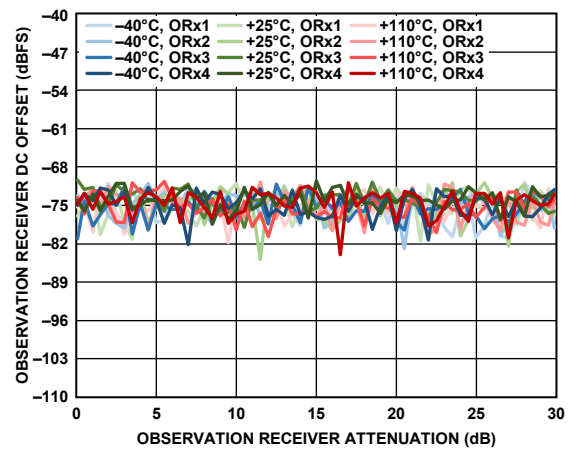

Figure 402. Observation Receiver DC Offset vs. Observation Receiver Attenuation, Sample Rate = 491.52 MSPS

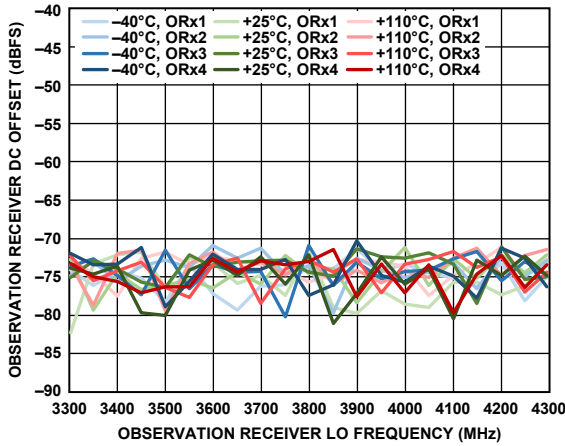

Figure 403. Observation Receiver DC Offset vs. Observation Receiver LO Frequency, Attenuation = 0 dB, Sample Rate = 491.52 MSPS

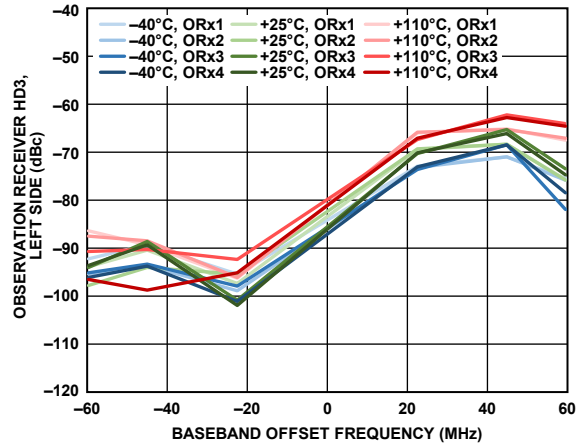

Figure 406. Observation Receiver HD3, Left Side vs. Baseband Offset Frequency, -10 dBFS Input Signal, Distortion Tone Measured Left of 0 Hz

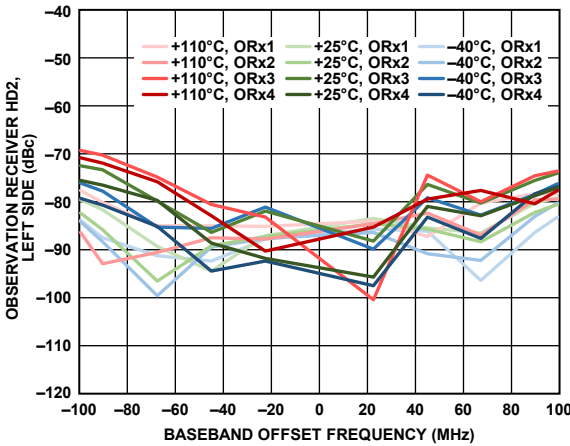

Figure 404. Observation Receiver HD2, Left Side vs. Baseband Offset Frequency, -10 dBFS Input Signal, Distortion Tone Measured Left of 0 Hz

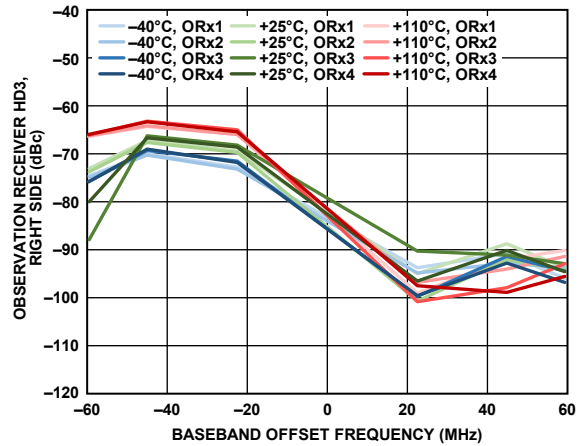

Figure 407. Observation Receiver HD3, Right Side vs. Baseband Offset Frequency, -10 dBFS Input Signal, Distortion Tone Measured Right of 0 Hz

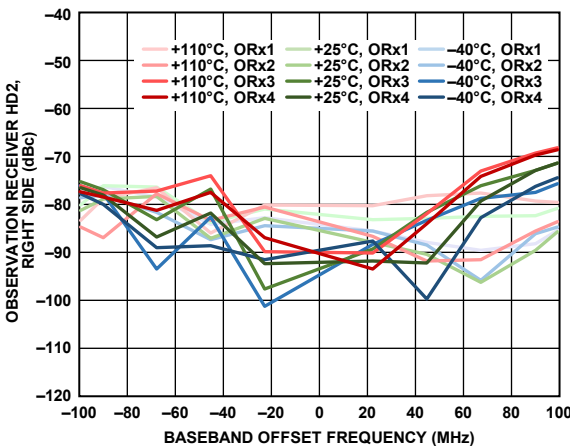

Figure 405. Observation Receiver HD2, Right Side vs. Baseband Offset Frequency, -10 dBFS Input Signal, Distortion Tone Measured Right of 0 Hz

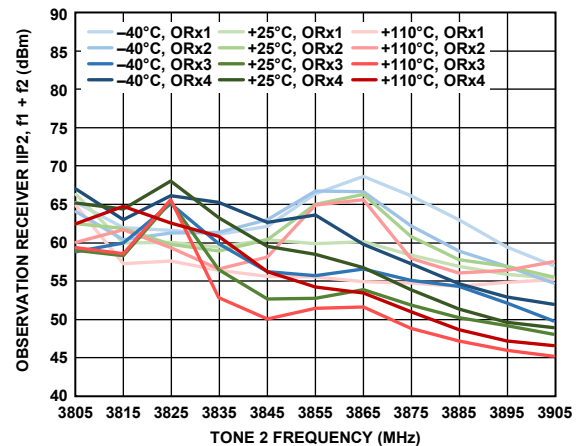

Figure 408. Observation Receiver IIP2,  $f_1 + f_2$  vs. Tone 2 Frequency, Both Tones at -13 dBFS,  $f_1 = f_2 + 2$  MHz

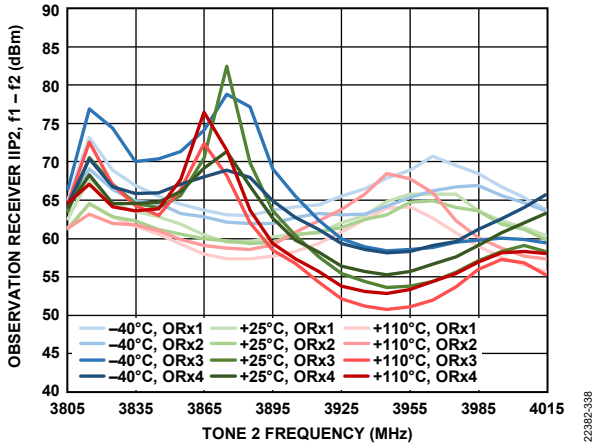

Figure 409. Observation Receiver IIP2,  $f_1 - f_2$  vs. Tone 2 Frequency, Both Tones at  $-13$  dBFS,  $f_1 = f_2 + 2$  MHz

22382-338

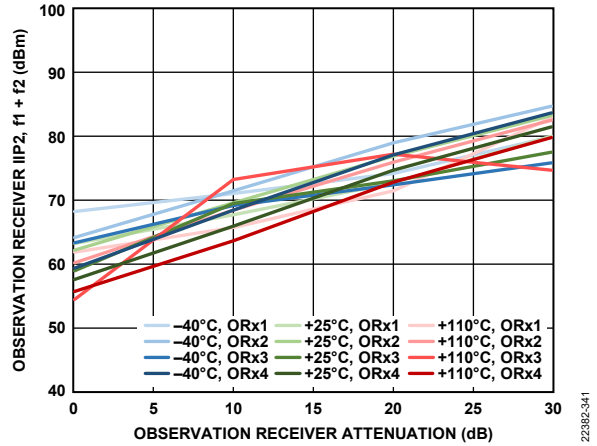

Figure 412. Observation Receiver IIP2,  $f_1 + f_2$  vs. Observation Receiver Attenuation, Both Tones at  $-13$  dBFS,  $f_1 = 102$  MHz,  $f_2 = 2$  MHz

22382-341

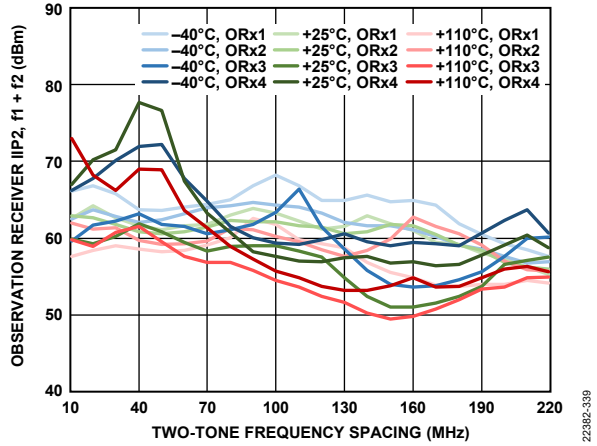

Figure 410. Observation Receiver IIP2,  $f_1 + f_2$  vs. Two-Tone Frequency Spacing, Both Tones at  $-13$  dBFS,  $f_2 = 2$  MHz

22382-339

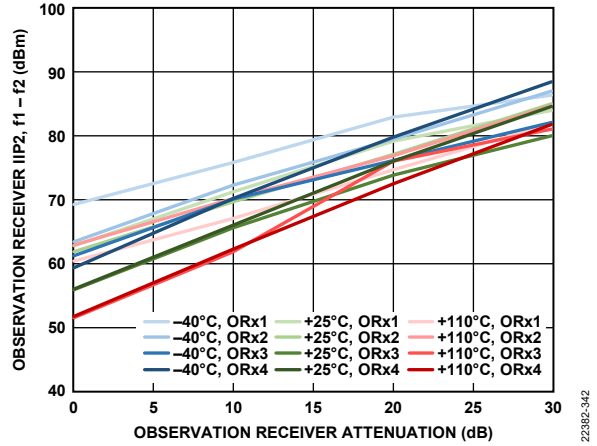

Figure 413. Observation Receiver IIP2,  $f_1 - f_2$  vs. Observation Receiver Attenuation, Both Tones at  $-13$  dBFS,  $f_1 = 102$  MHz,  $f_2 = 2$  MHz

22382-342

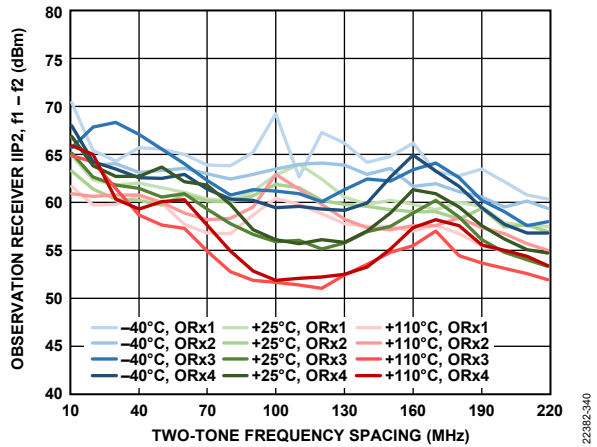

Figure 411. Observation Receiver IIP2,  $f_1 - f_2$  vs. Two-Tone Frequency Spacing, Both Tones at  $-13$  dBFS,  $f_2 = 2$  MHz

22382-340

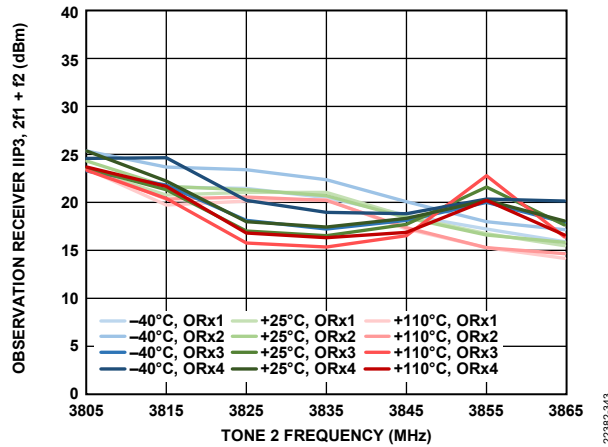

Figure 414. Observation Receiver IIP3,  $2f_1 + f_2$  vs. Tone 2 Frequency, Both Tones at  $-13$  dBFS,  $f_1 = f_2 + 2$  MHz

22382-343

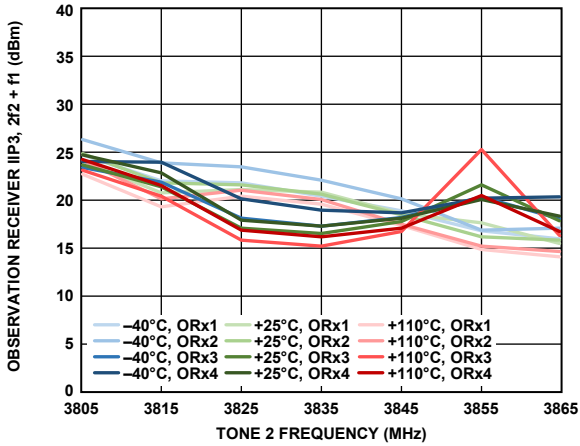

Figure 415. Observation Receiver IIP3,  $2f_2 + f_1$  vs. Tone 2 Frequency, Both Tones at  $-13$  dBFS,  $f_1 = f_2 + 2$  MHz

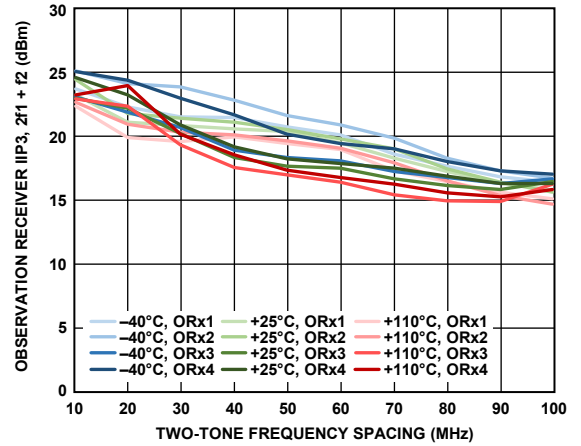

Figure 418. Observation Receiver IIP3,  $2f_1 + f_2$  vs. Two-Tone Frequency Spacing, Both Tones at  $-13$  dBFS,  $f_2 = 2$  MHz

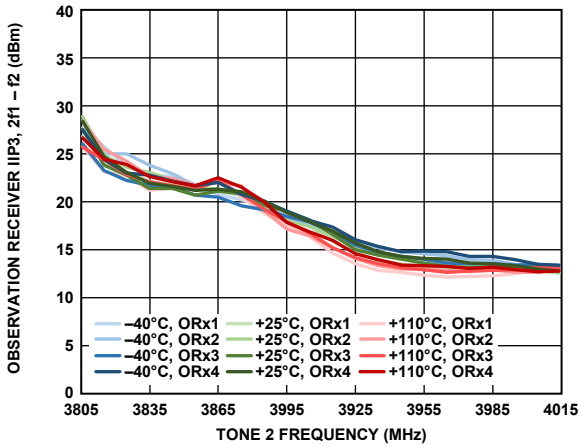

Figure 416. Observation Receiver IIP3,  $2f_1 - f_2$  vs. Tone 2 Frequency, Both Tones at  $-13$  dBFS,  $f_1 = f_2 + 2$  MHz

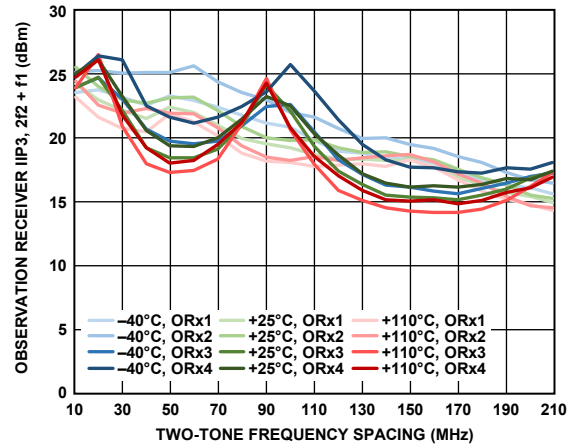

Figure 419. Observation Receiver IIP3,  $2f_2 + f_1$  vs. Two-Tone Frequency Spacing, Both Tones at  $-13$  dBFS,  $f_2 = 2$  MHz

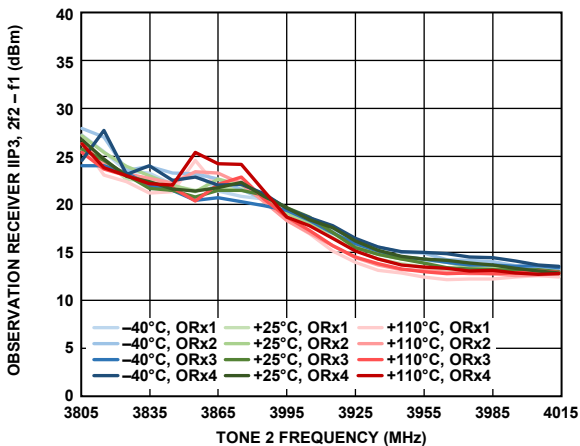

Figure 417. Observation Receiver IIP3,  $2f_2 - f_1$  vs. Tone 2 Frequency, Both Tones at  $-13$  dBFS,  $f_1 = f_2 + 2$  MHz

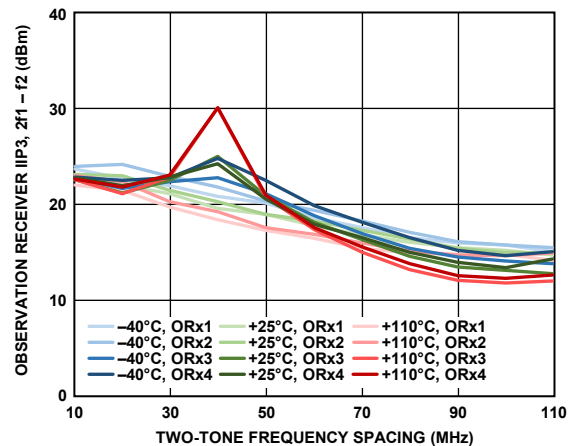

Figure 420. Observation Receiver IIP3,  $2f_1 - f_2$  vs. Two-Tone Frequency Spacing, Both Tones at  $-13$  dBFS,  $f_2 = 2$  MHz

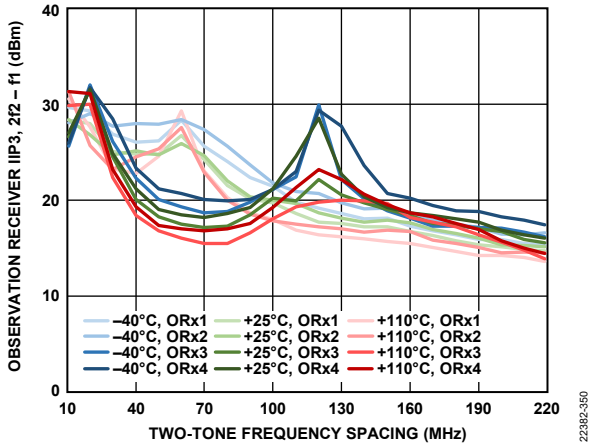

Figure 421. Observation Receiver IIP3,  $2f_2 - f_1$  vs. Two-Tone Frequency Spacing, Both Tones at  $-13$  dBFS,  $f_2 = 2$  MHz

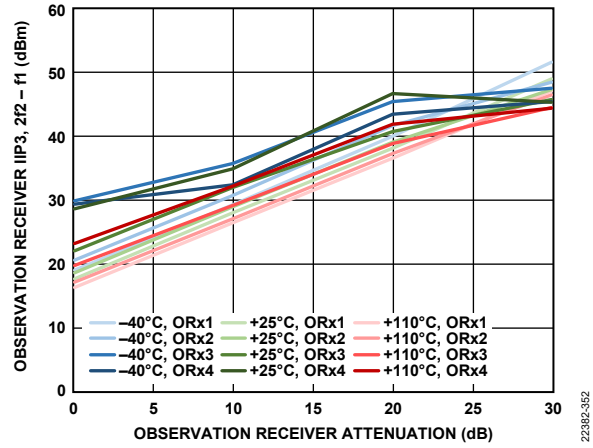

Figure 423. Observation Receiver IIP3,  $2f_2 - f_1$  vs. Observation Receiver Attenuation, Both Tones at  $-13$  dBFS,  $f_1 = 122$  MHz,  $f_2 = 2$  MHz

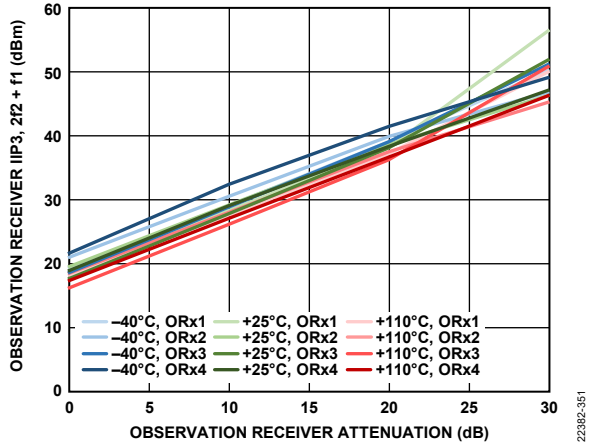

Figure 422. Observation Receiver IIP3,  $2f_2 + f_1$  vs. Observation Receiver Attenuation, Both Tones at  $-13$  dBFS,  $f_1 = 122$  MHz,  $f_2 = 2$  MHz



**4800 MHZ BAND**

Device configuration profile: receiver = 200 MHz bandwidth, I/Q rate = 245.76 MHz, transmitter = 200 MHz large signal bandwidth plus 450 MHz synthesis bandwidth, I/Q rate = 491.52 MHz, observation receiver (OR<sub>x</sub>) = 450 MHz bandwidth, I/Q rate = 491.52 MHz, device clock = 245.76 MHz, unless otherwise noted. The temperature settings refer to the die temperature. All LO frequencies set to 4800 MHz, unless otherwise noted.

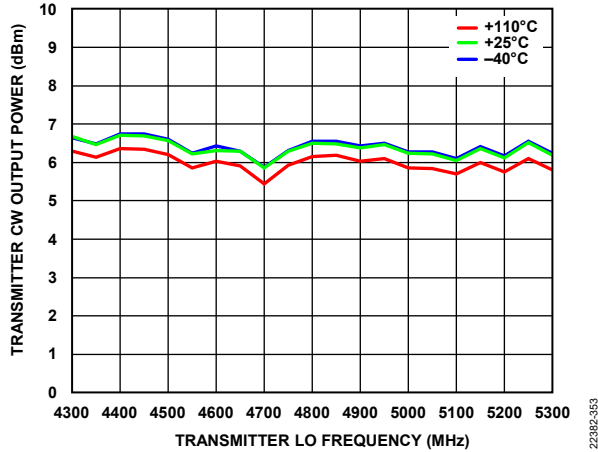

Figure 424. Transmitter CW Output Power vs. Transmitter LO Frequency, 10 MHz Offset, 0 dB Attenuation

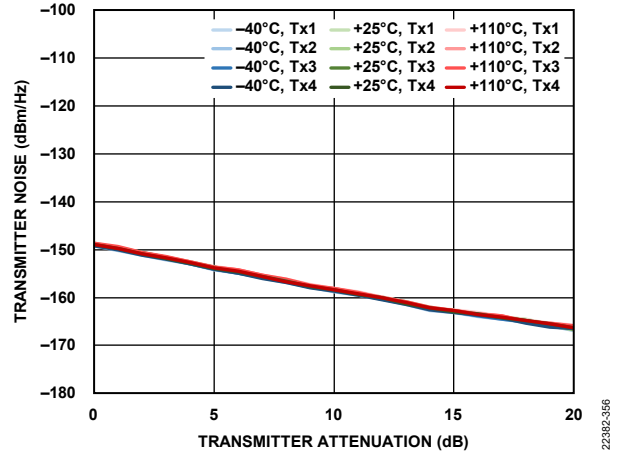

Figure 427. Transmitter Noise vs. Transmitter Attenuation, 10 MHz Offset Frequency

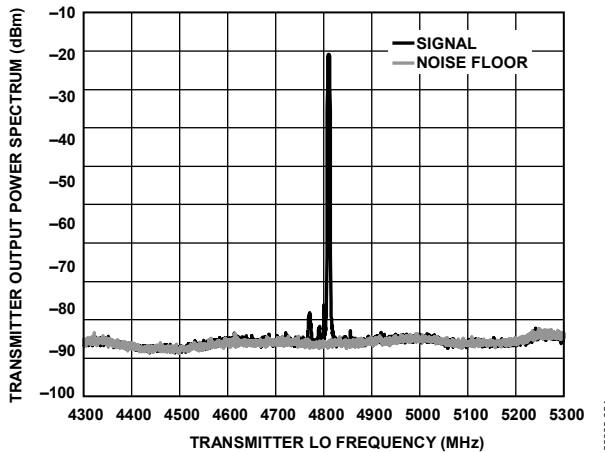

Figure 425. Transmitter Output Power Spectrum, Tx1, 5 MHz LTE, 10 MHz Offset, -10 dBFS RMS, 1 MHz Resolution Bandwidth, T<sub>J</sub> = 25°C

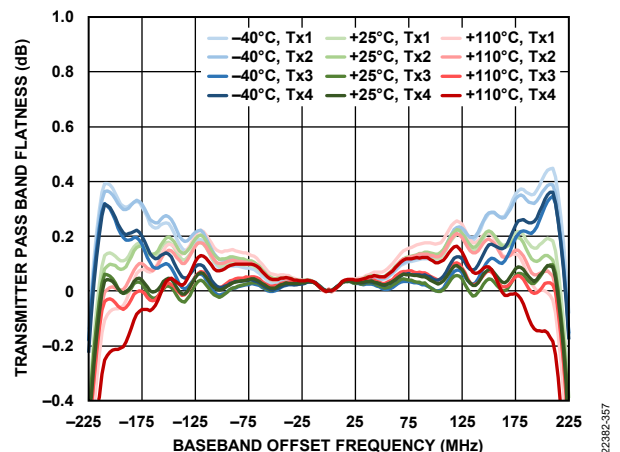

Figure 428. Transmitter Pass Band Flatness vs. Baseband Offset Frequency

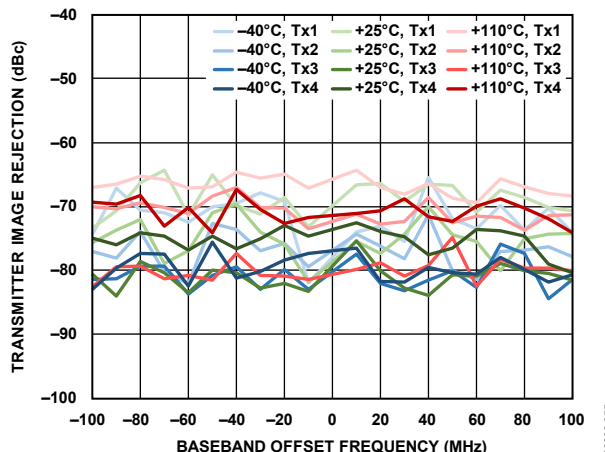

Figure 426. Transmitter Image Rejection Across Large Signal Bandwidth vs. Baseband Offset Frequency

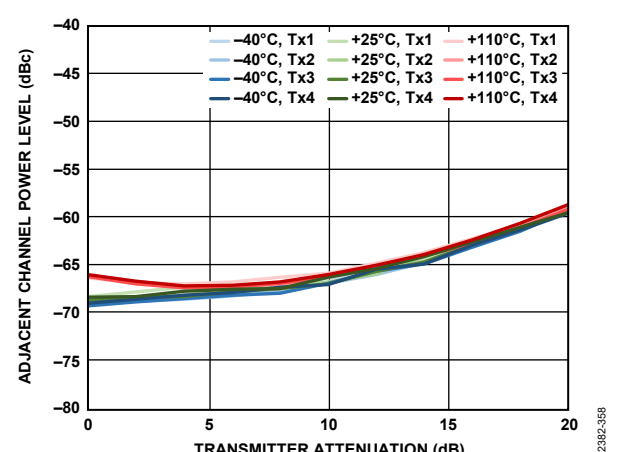

Figure 429. Adjacent Channel Power Level vs. Transmitter Attenuation, -10 MHz Baseband Offset, 20 MHz LTE, PAR = 12 dB

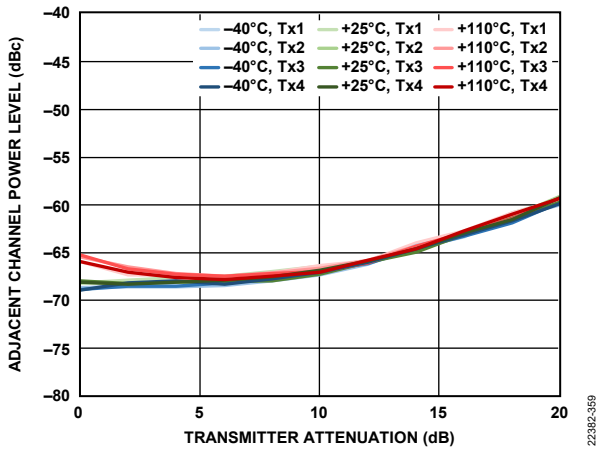

Figure 430. Adjacent Channel Power Level vs. Transmitter Attenuation, 90 MHz Baseband Offset, 20 MHz LTE, PAR = 12 dB

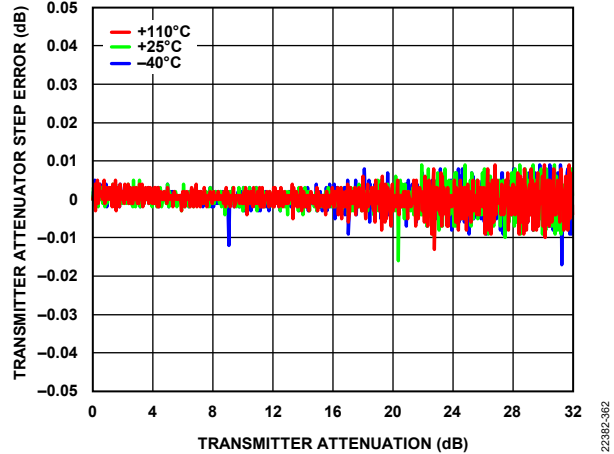

Figure 433. Transmitter Attenuator Step Error vs. Transmitter Attenuation, 10 MHz Offset

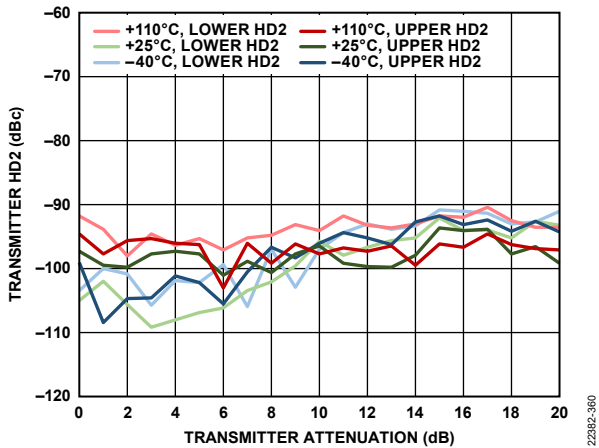

Figure 431. Transmitter Second Harmonic Distortion (HD2) vs. Transmitter Attenuation, 10 MHz Offset

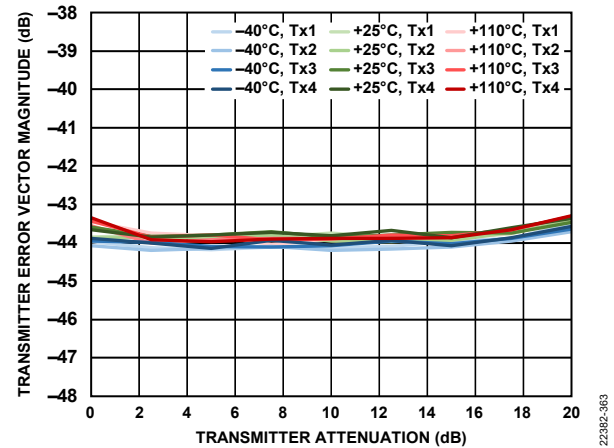

Figure 434. Transmitter Error Vector Magnitude vs. Transmitter Attenuation, 20 MHz LTE Signal Centered at LO Frequency, Sample Rate = 491.52 MSPS, Loop Filter Bandwidth = 400 kHz, Loop Filter Phase Margin = 60°

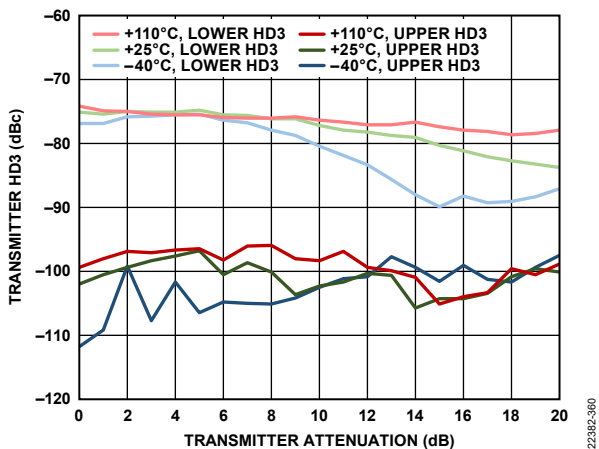

Figure 432. Transmitter Third Harmonic Distortion (HD3) vs. Transmitter Attenuation, 10 MHz Offset

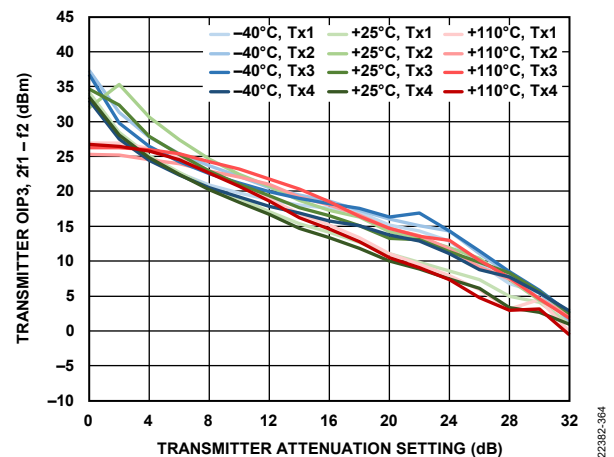

Figure 435. Transmitter OIP3, 2f1 - f2 vs. Transmitter Attenuation, 15 dB Digital Back Off per Tone, f1 = 50.5 MHz, f2 = 55.5 MHz

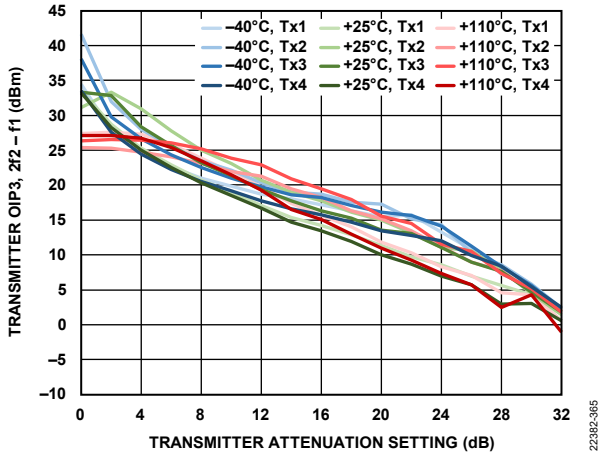

Figure 436. Transmitter OIP3, 2f2 - f1 vs. Transmitter Attenuation, 15 dB Digital Back Off per Tone, f1 = 50.5 MHz, f2 = 55.5 MHz

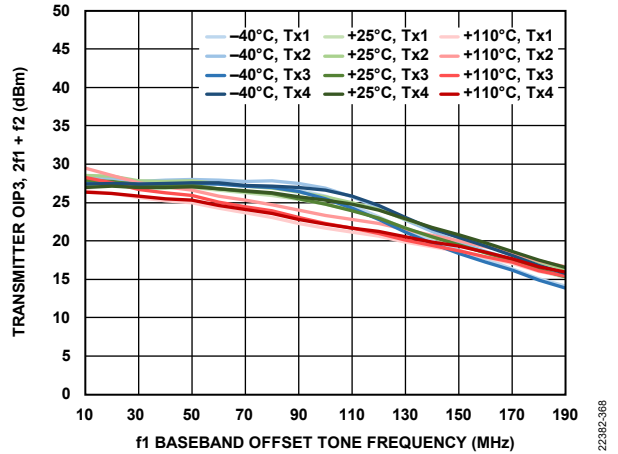

Figure 439. Transmitter OIP3, 2f1 + f2 vs. f1 Baseband Offset Tone Frequency, f2 = f1 + 5 MHz, 15 dB Digital Back Off per Tone

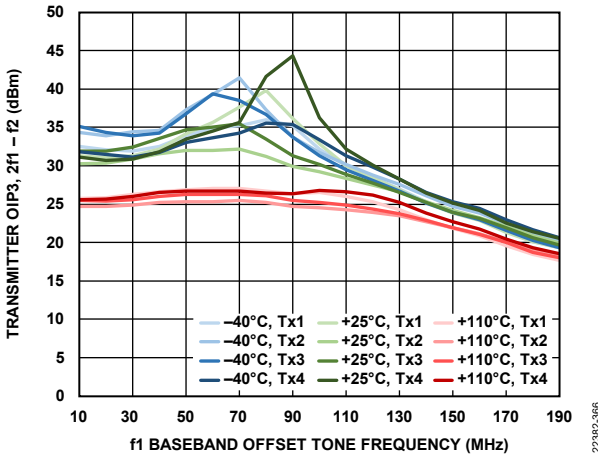

Figure 437. Transmitter OIP3, 2f1 - f2 vs. f1 Baseband Offset Tone Frequency, f2 = f1 + 5 MHz, 15 dB Digital Back Off per Tone

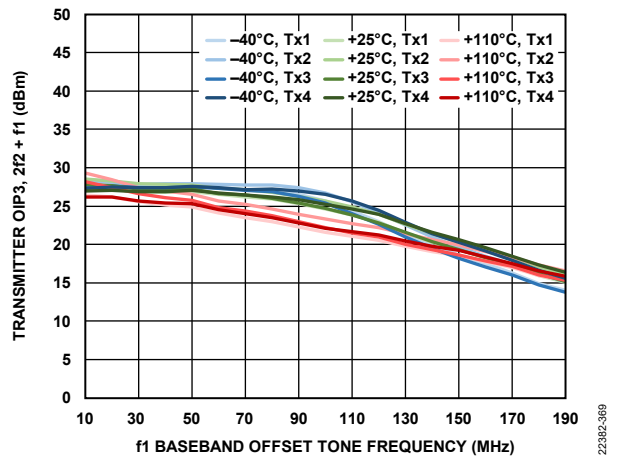

Figure 440. Transmitter OIP3, 2f2 + f1 vs. f1 Baseband Offset Tone Frequency, f2 = f1 + 5 MHz, 15 dB Digital Back Off per Tone

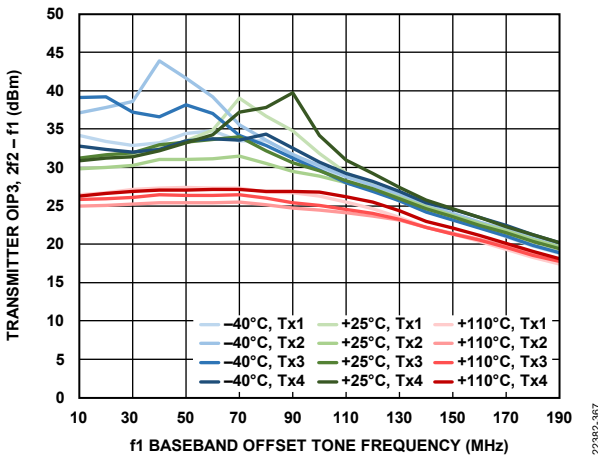

Figure 438. Transmitter OIP3, 2f2 - f1 vs. f1 Baseband Offset Tone Frequency, f2 = f1 + 5 MHz, 15 dB Digital Back Off per Tone

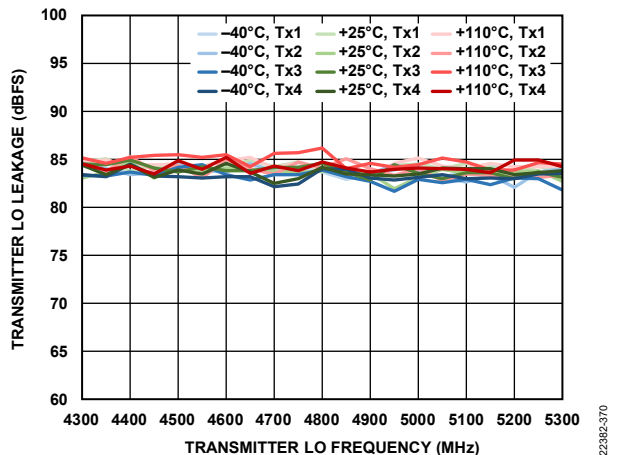

Figure 441. Transmitter LO Leakage vs. Transmitter LO Frequency

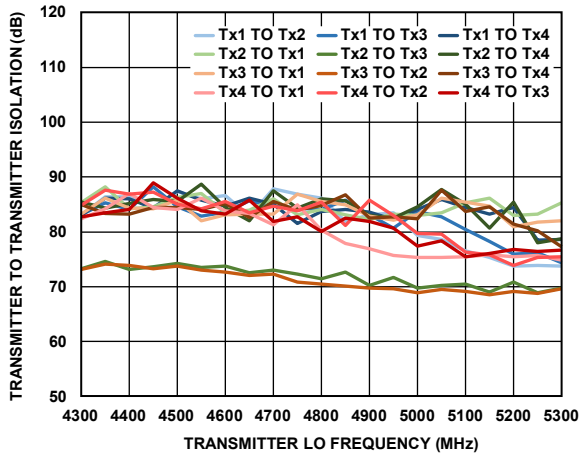

Figure 442. Transmitter to Transmitter Isolation vs. Transmitter LO Frequency

22382-371

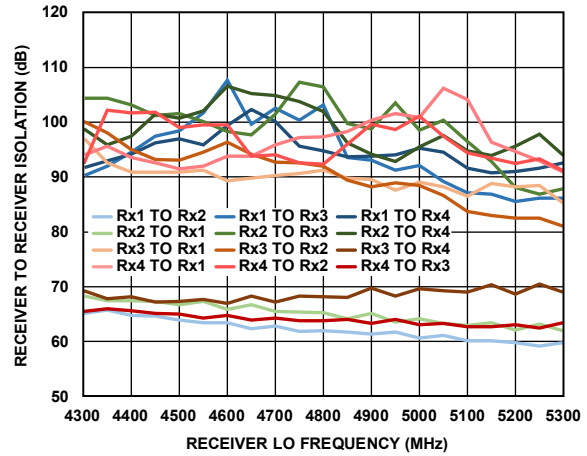

Figure 445. Receiver to Receiver Isolation vs. Receiver LO Frequency

22382-374

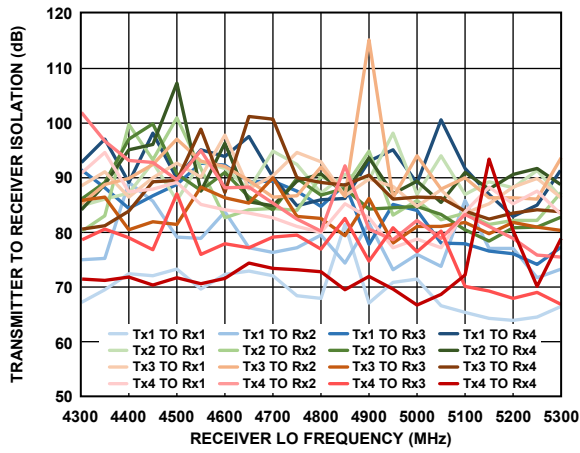

Figure 443. Transmitter to Receiver Isolation vs. Receiver LO Frequency

22382-372

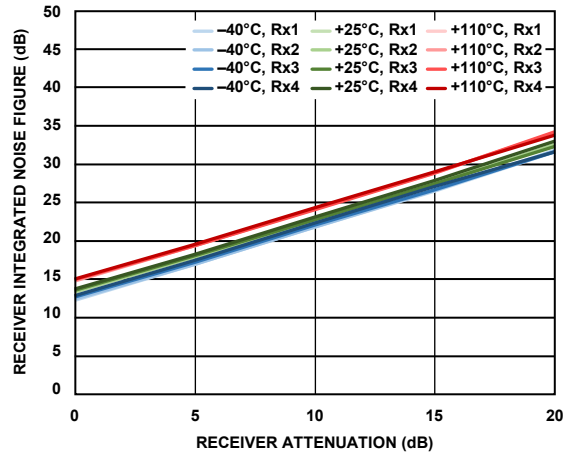

Figure 446. Receiver Integrated Noise Figure vs. Receiver Attenuation, 200 MHz Bandwidth, Sample Rate = 245.76 MSPS, Integration Bandwidth = 500 kHz to 100 MHz

22382-375

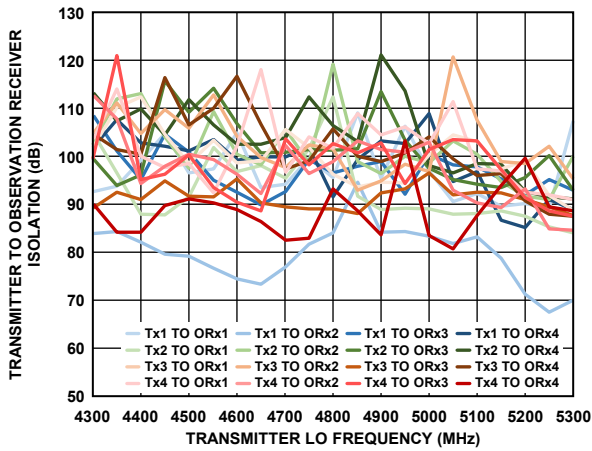

Figure 444. Transmitter to Observation Receiver Isolation vs. Transmitter LO Frequency

22382-373

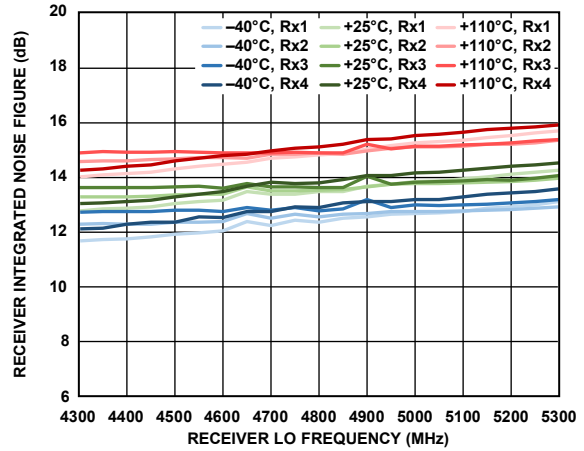

Figure 447. Receiver Integrated Noise Figure vs. Receiver LO Frequency, 200 MHz Bandwidth, Sample Rate = 245.76 MSPS, Integration Bandwidth = 500 kHz to 100 MHz

22382-376

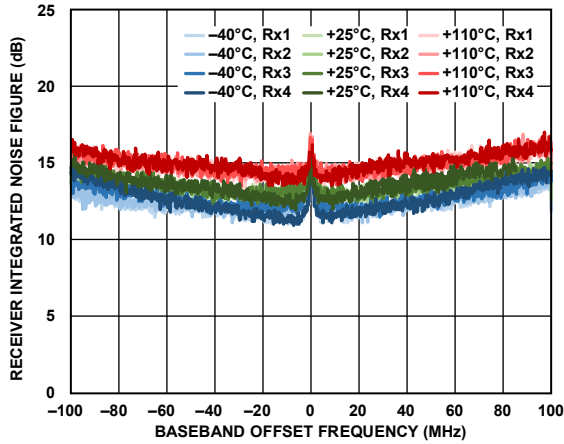

Figure 448. Receiver Integrated Noise Figure vs. Baseband Offset Frequency, 200 MHz Bandwidth, Sample Rate = 245.76 MSPS, Integrated in 200 kHz Steps

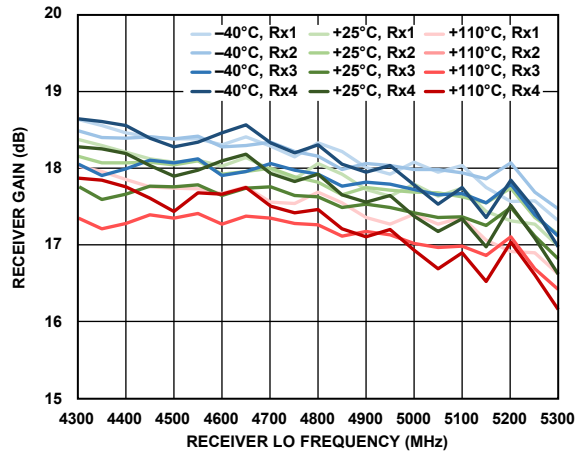

Figure 451. Receiver Gain vs. Receiver LO Frequency, 200 MHz Bandwidth, Sample Rate = 245.76 MSPS

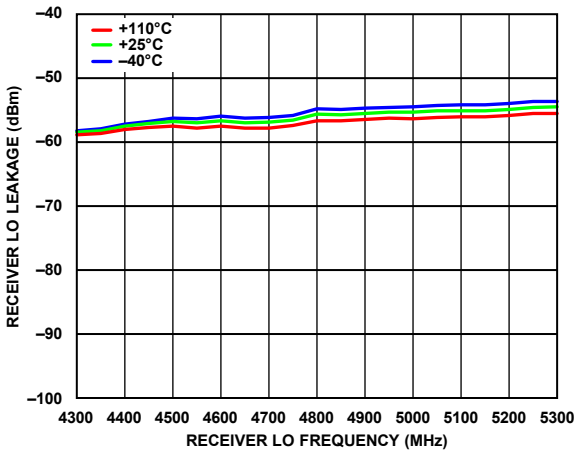

Figure 449. Receiver LO Leakage vs. Receiver LO Frequency, Attenuation = 0 dB, Sample Rate = 245.76 MSPS

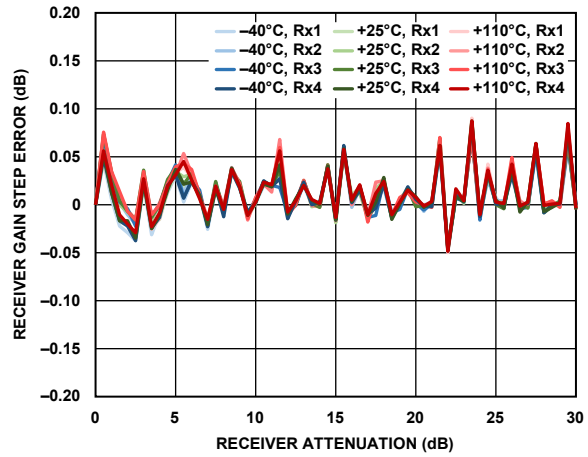

Figure 452. Receiver Gain Step Error vs. Receiver Attenuation, 20 MHz Offset, -5 dBFS Input Signal

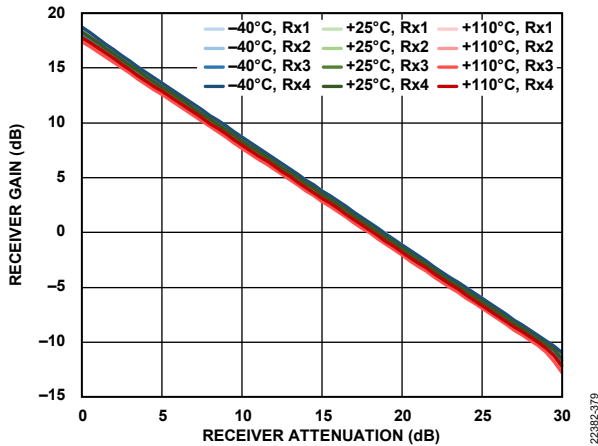

Figure 450. Receiver Gain vs. Receiver Attenuation, 20 MHz Offset, 200 MHz Bandwidth, Sample Rate = 245.76 MSPS

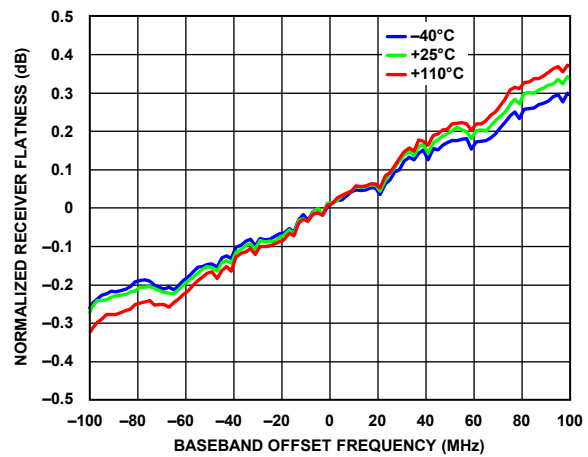

Figure 453. Normalized Receiver Flatness vs. Baseband Offset Frequency, -5 dBFS Input Signal

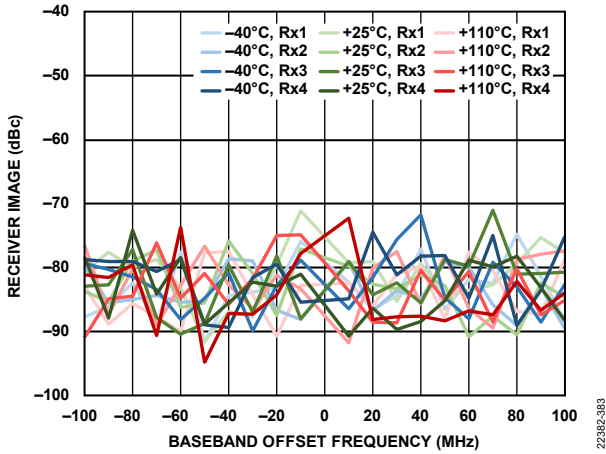

Figure 454. Receiver Image vs. Baseband Offset Frequency, Tracking Calibration Active, Sample Rate = 245.76 MSPS

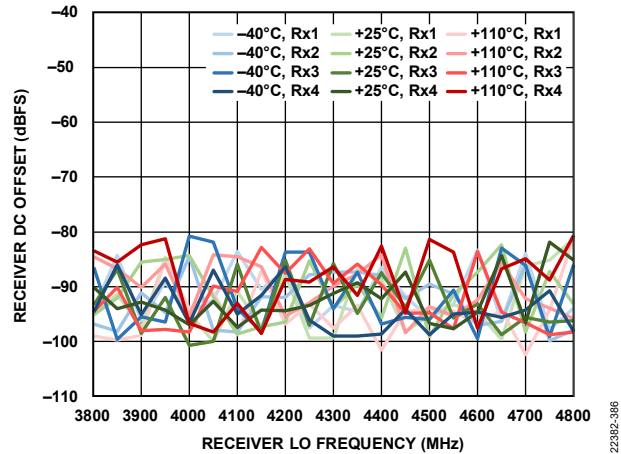

Figure 457. Receiver DC Offset vs. Receiver LO Frequency, Attenuation = 0 dB, Sample Rate = 245.76 MSPS

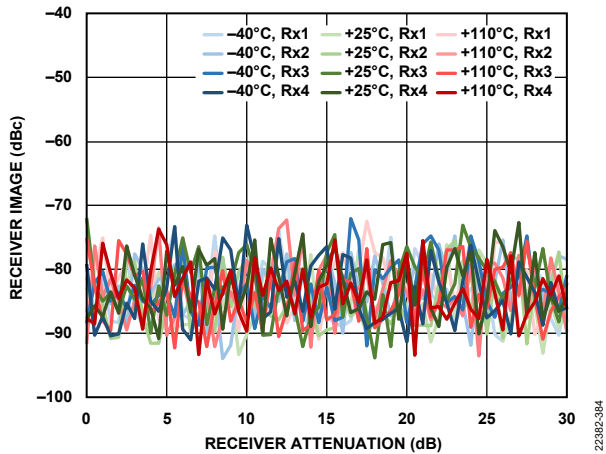

Figure 455. Receiver Image vs. Receiver Attenuation, 20 MHz Offset, Tracking Calibration Active, Sample Rate = 245.76 MSPS

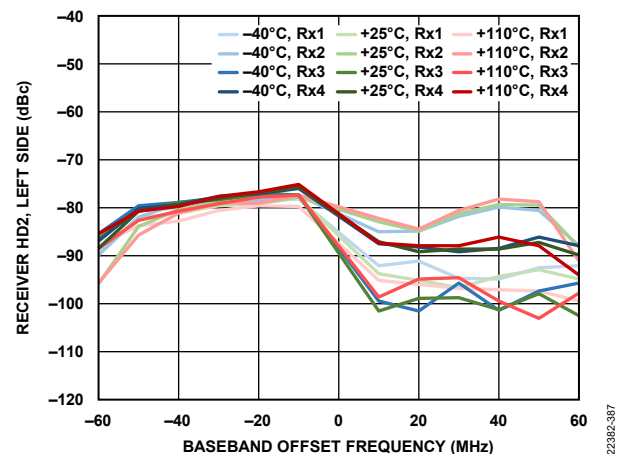

Figure 458. Receiver HD2, Left Side vs. Baseband Offset Frequency, -5 dBFS Input Signal, Distortion Tone Measured Left of 0 Hz (HD2 Canceller Not Enabled)

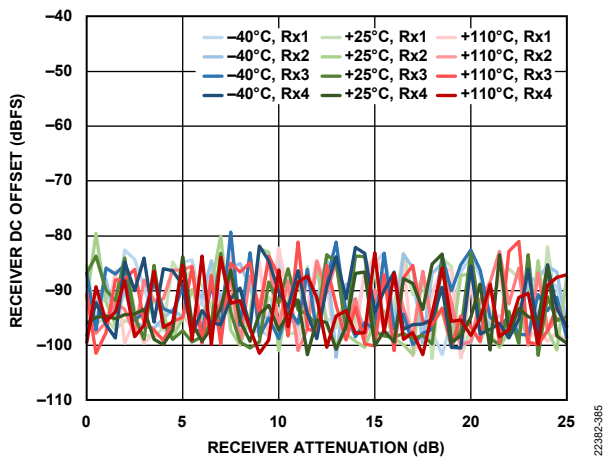

Figure 456. Receiver DC Offset vs. Receiver Attenuation, 20 MHz Offset, -5 dBFS Input Signal, Sample Rate = 245.76 MSPS

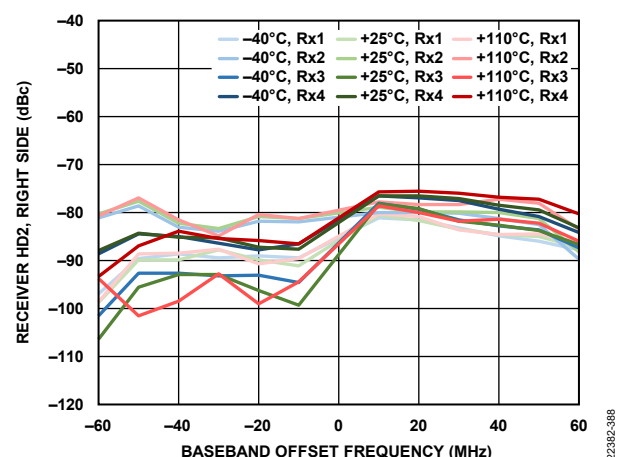

Figure 459. Receiver HD2, Right Side vs. Baseband Offset Frequency, -5 dBFS Input Signal, Distortion Tone Measured Right of 0 Hz (HD2 Canceller Not Enabled)

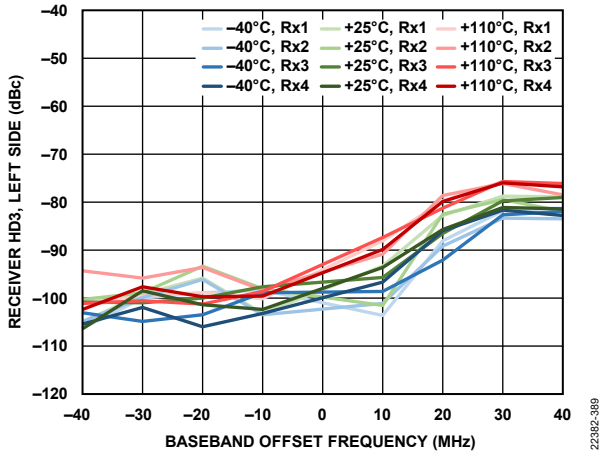

Figure 460. Receiver HD3, Left Side vs. Baseband Offset Frequency, -5 dBFS Input Signal, Distortion Tone Measured Left of 0 Hz

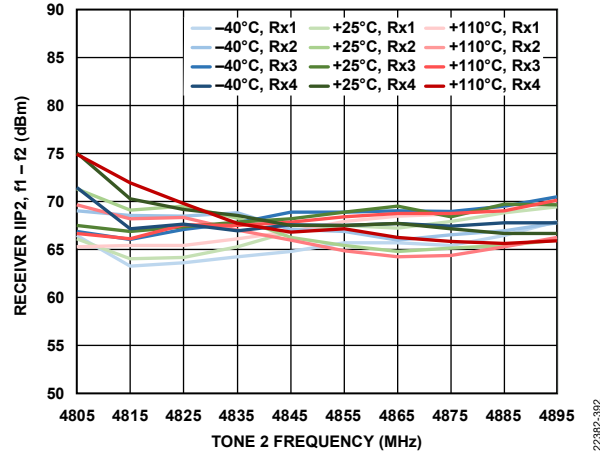

Figure 463. Receiver IIP2,  $f_1 - f_2$  vs. Tone 2 Frequency, Both Tones at -11 dBFS,  $f_1 = f_2 + 2$  MHz

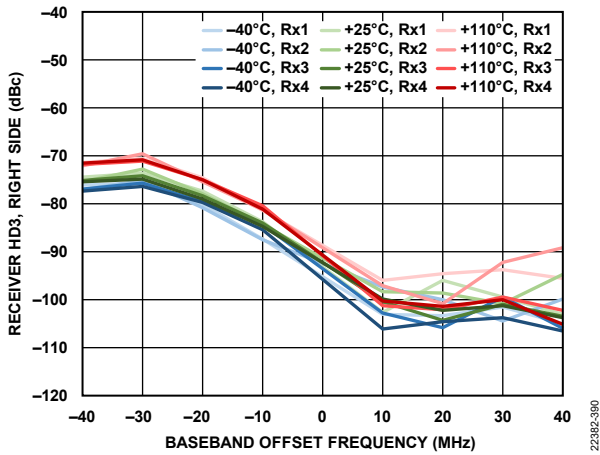

Figure 461. Receiver HD3, Right Side vs. Baseband Offset Frequency, -5 dBFS Input Signal, Distortion Tone Measured Right of 0 Hz

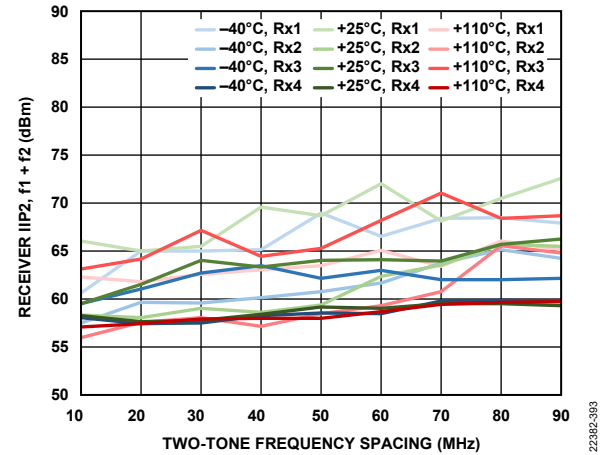

Figure 464. Receiver IIP2,  $f_1 + f_2$  vs. Two-Tone Frequency Spacing, Both Tones at -11 dBFS,  $f_2 = 2$  MHz

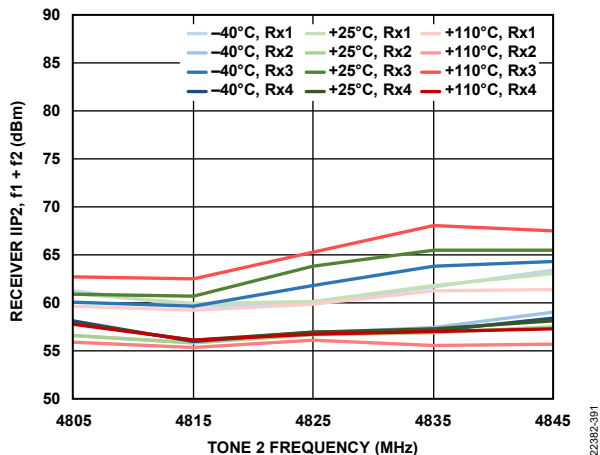

Figure 462. Receiver IIP2,  $f_1 + f_2$  vs. Tone 2 Frequency, Both Tones at -11 dBFS,  $f_1 = f_2 + 2$  MHz

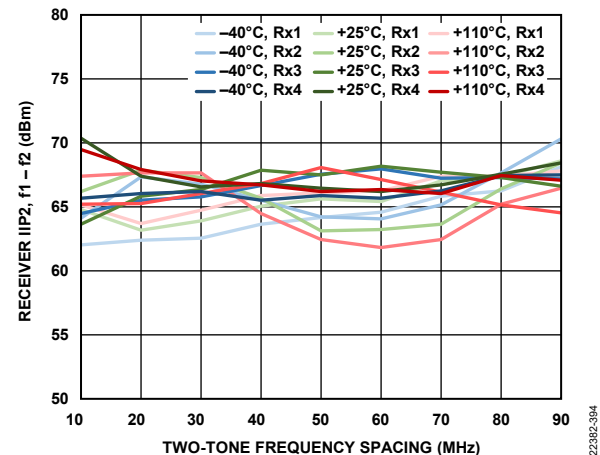

Figure 465. Receiver IIP2,  $f_1 - f_2$  vs. Two-Tone Frequency Spacing, Both Tones at -11 dBFS,  $f_2 = 2$  MHz

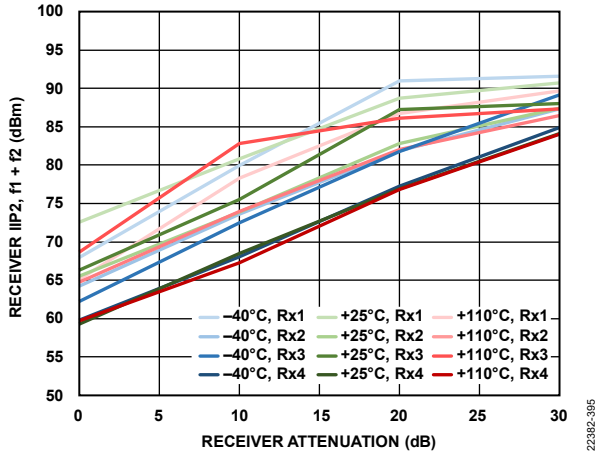

Figure 466. Receiver IIP2,  $f_1 + f_2$  vs. Receiver Attenuation, Both Tones at  $-11$  dBFS,  $f_1 = 92$  MHz,  $f_2 = 2$  MHz

22382-395

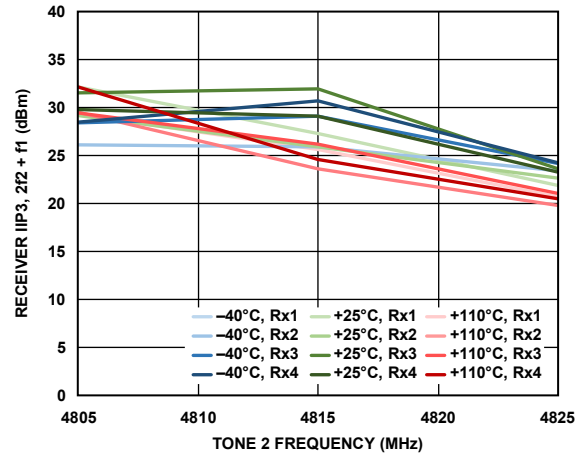

Figure 469. Receiver IIP3,  $2f_2 + f_1$  vs. Tone 2 Frequency, Both Tones at  $-11$  dBFS,  $f_1 = f_2 + 2$  MHz

22382-398

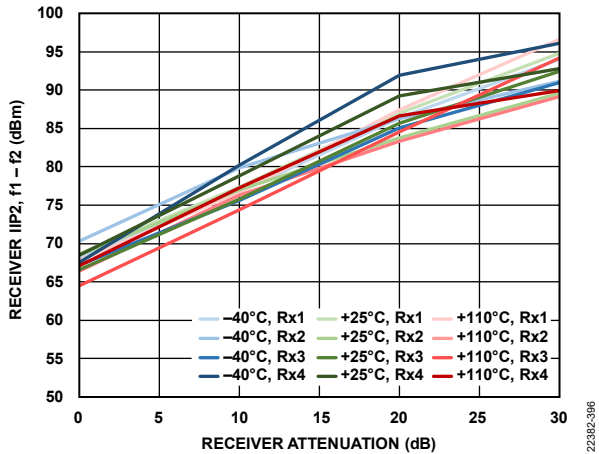

Figure 467. Receiver IIP2,  $f_1 - f_2$  vs. Receiver Attenuation, Both Tones at  $-11$  dBFS,  $f_1 = 92$  MHz,  $f_2 = 2$  MHz

22382-396

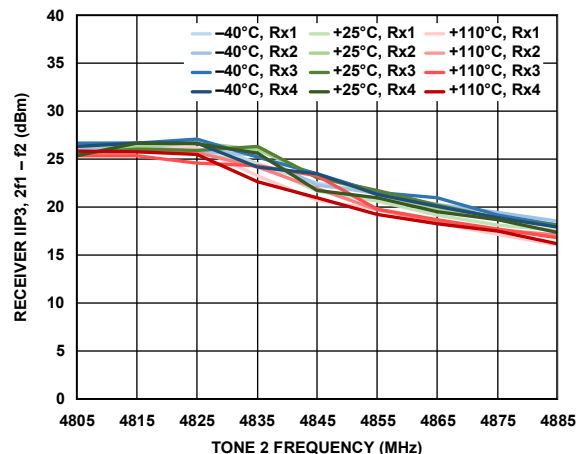

Figure 470. Receiver IIP3,  $2f_1 - f_2$  vs. Tone 2 Frequency, Both Tones at  $-11$  dBFS,  $f_1 = f_2 + 2$  MHz

22382-399

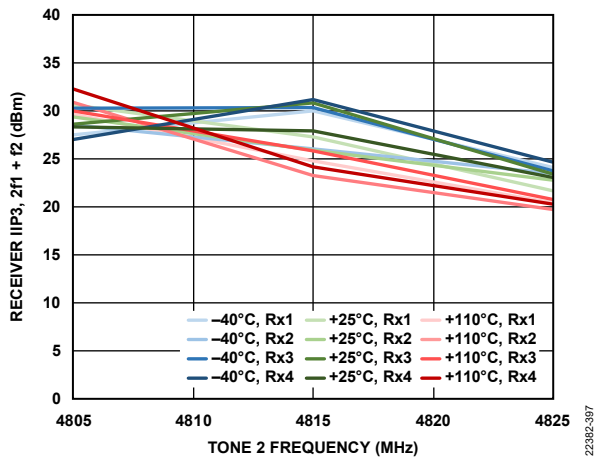

Figure 468. Receiver IIP3,  $2f_1 + f_2$  vs. Tone 2 Frequency, Both Tones at  $-11$  dBFS,  $f_1 = f_2 + 2$  MHz

22382-397

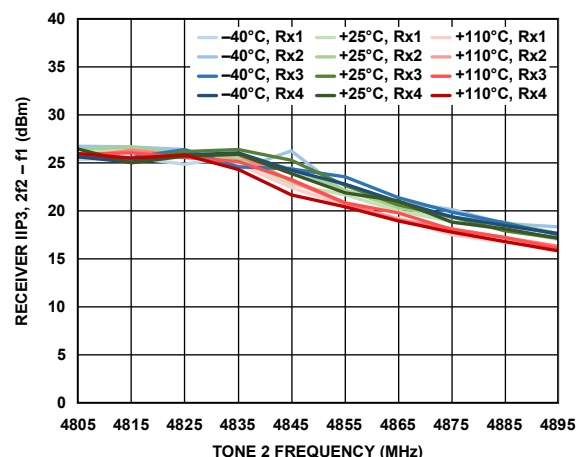

Figure 471. Receiver IIP3,  $2f_2 - f_1$  vs. Tone 2 Frequency, Both Tones at  $-11$  dBFS,  $f_1 = f_2 + 2$  MHz

22382-400



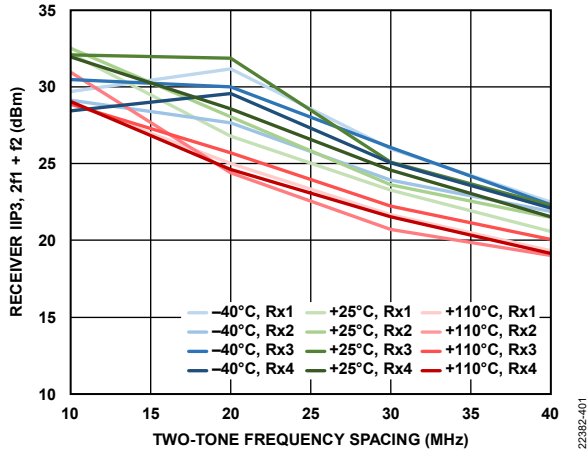

Figure 472. Receiver IIP3,  $2f_1 + f_2$  vs. Two-Tone Frequency Spacing, Both Tones at  $-11$  dBFS,  $f_2 = 2$  MHz

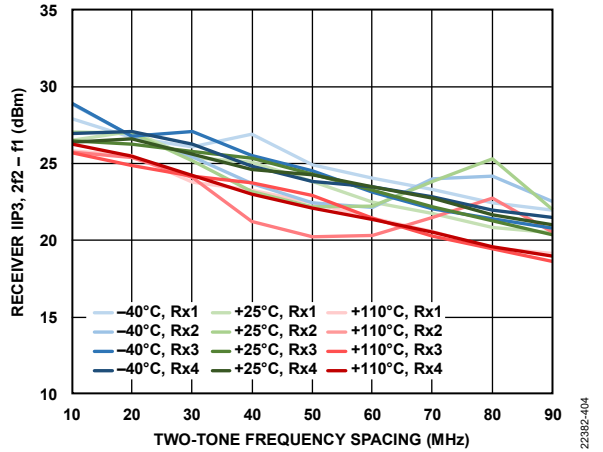

Figure 475. Receiver IIP3,  $2f_2 - f_1$  vs. Two-Tone Frequency Spacing, Both Tones at  $-11$  dBFS,  $f_2 = 2$  MHz

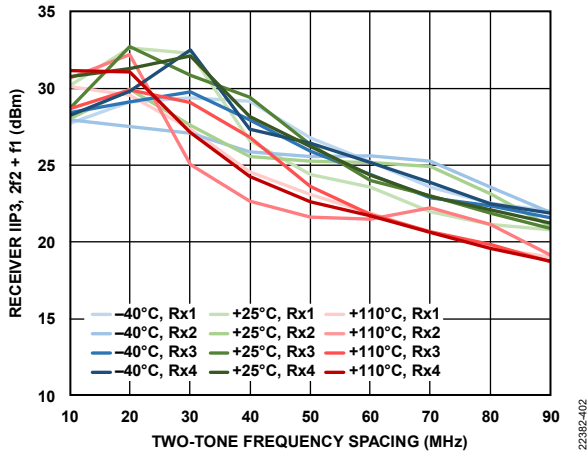

Figure 473. Receiver IIP3,  $2f_2 + f_1$  vs. Two-Tone Frequency Spacing, Both Tones at  $-11$  dBFS,  $f_2 = 2$  MHz

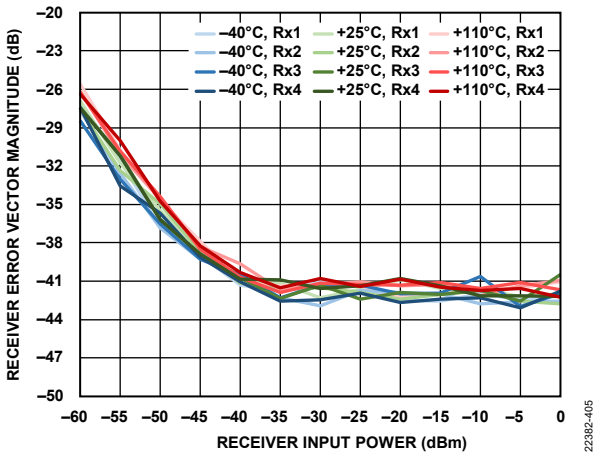

Figure 476. Receiver Error Vector Magnitude vs. Receiver Input Power, 20 MHz LTE Signal Centered at LO Frequency, Sample Rate = 245.76 MSPS, Loop Filter Bandwidth = 400 kHz, Loop Filter Phase Margin =  $60^\circ$

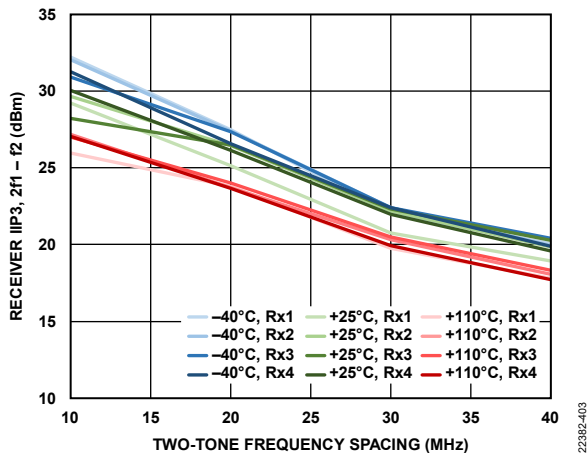

Figure 474. Receiver IIP3,  $2f_1 - f_2$  vs. Two-Tone Frequency Spacing, Both Tones at  $-11$  dBFS,  $f_2 = 2$  MHz

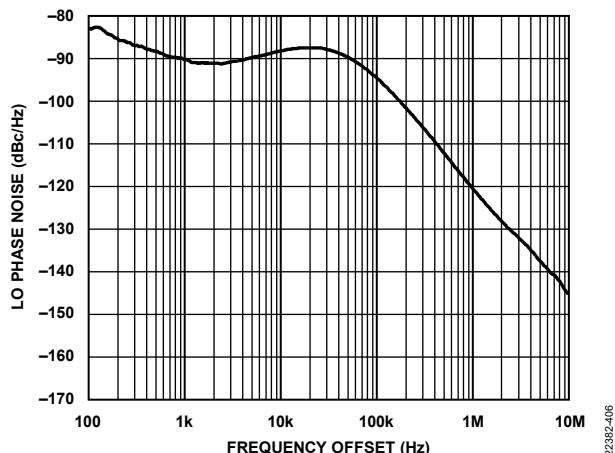

Figure 477. LO Phase Noise vs. Frequency Offset, Loop Bandwidth = 75 kHz, Phase Margin =  $85^\circ$

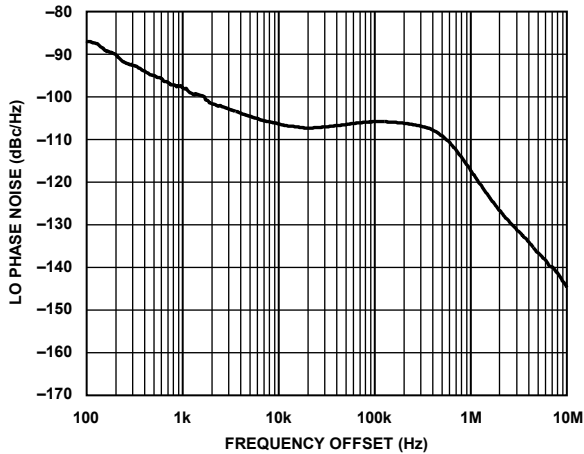

Figure 478. LO Phase Noise vs. Frequency Offset, Loop Bandwidth = 400 kHz, Phase Margin = 60°

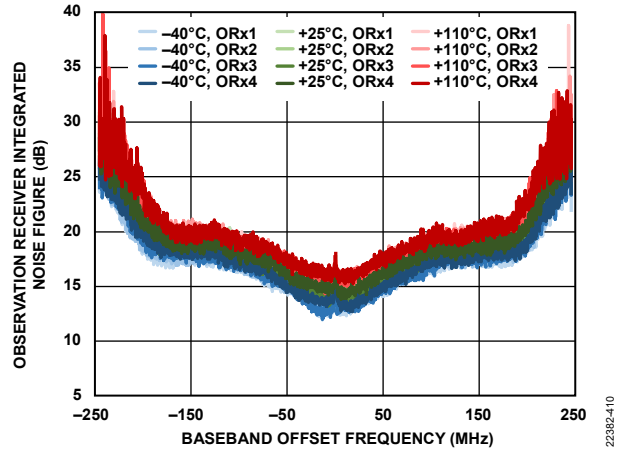

Figure 481. Observation Receiver Integrated Noise Figure vs. Baseband Offset Frequency, 450 MHz Bandwidth, Sample Rate = 491.52 MSPS, Integrated in 200 kHz Steps

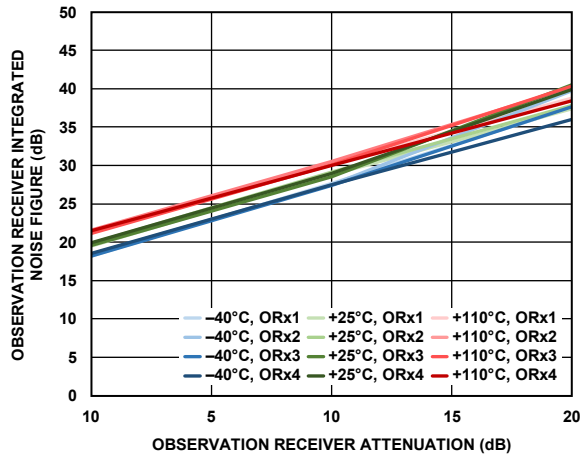

Figure 479. Observation Receiver Integrated Noise Figure vs. Observation Receiver Attenuation, 450 MHz Bandwidth, Sample Rate = 491.52 MSPS, Integration Bandwidth = 500 kHz to 245.76 MHz

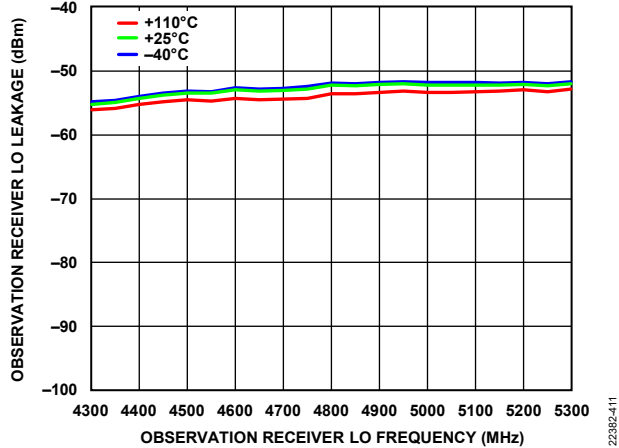

Figure 482. Observation Receiver LO Leakage vs. Observation Receiver LO Frequency, Attenuation = 0 dB, Sample Rate = 491.52 MSPS

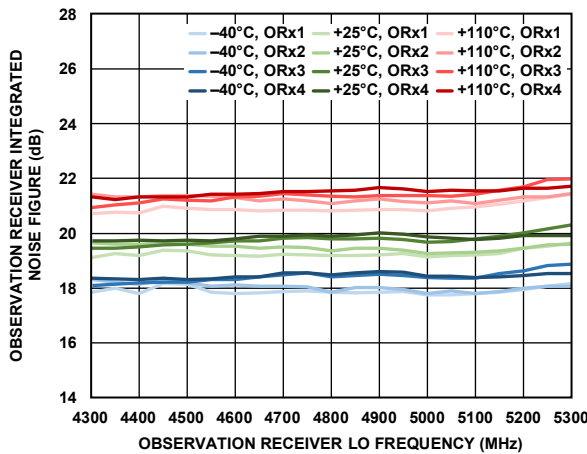

Figure 480. Observation Receiver Integrated Noise Figure vs. Observation Receiver LO Frequency, 450 MHz Bandwidth, Sample Rate = 491.52 MSPS, Integration Bandwidth = 500 kHz to 245.76 MHz

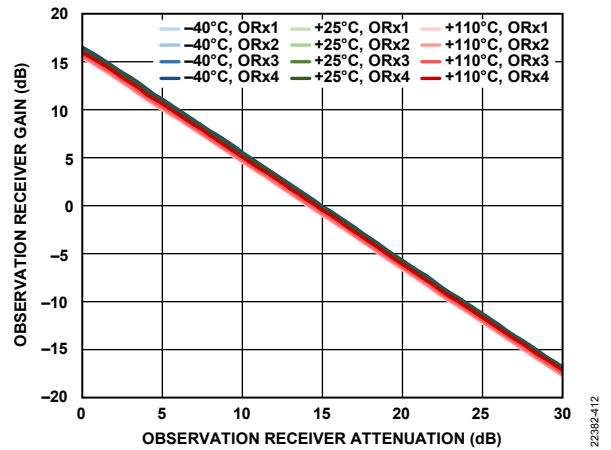

Figure 483. Observation Receiver Gain vs. Observation Receiver Attenuation, 45 MHz Offset, 450 MHz Bandwidth, Sample Rate = 491.52 MSPS

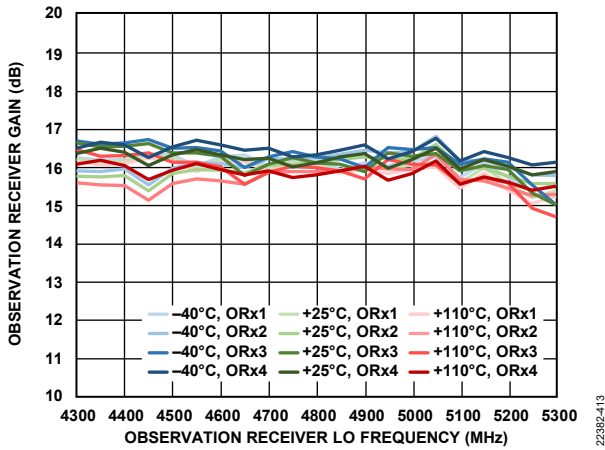

Figure 484. Observation Receiver Gain vs. Observation Receiver LO Frequency, 450 MHz Bandwidth, Sample Rate = 491.52 MSPS

22382-413

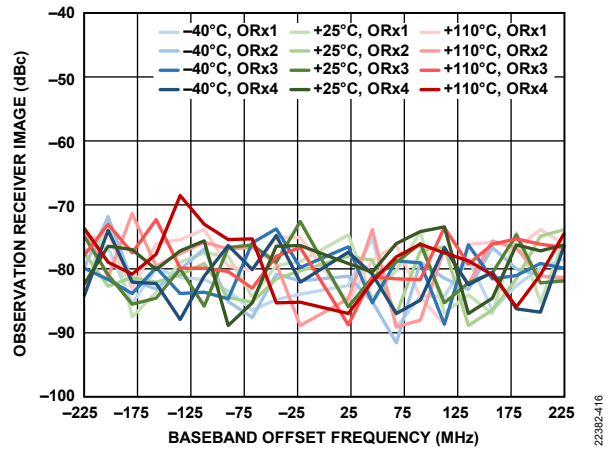

Figure 487. Observation Receiver Image vs. Baseband Offset Frequency, Tracking Calibration Active, Sample Rate = 491.52 MSPS

22382-416

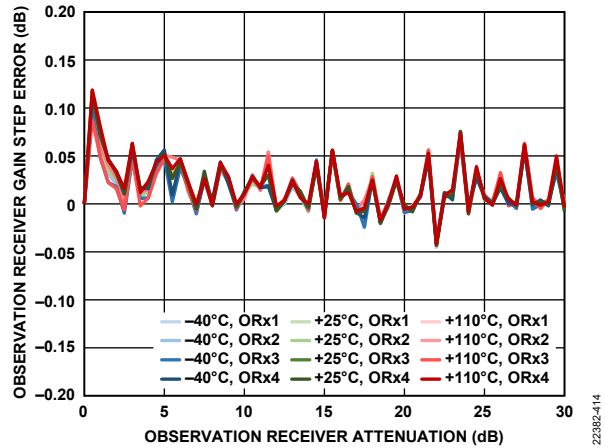

Figure 485. Observation Receiver Gain Step Error vs. Observation Receiver Attenuation, 45 MHz Offset, -10 dBFS Input Signal

22382-414

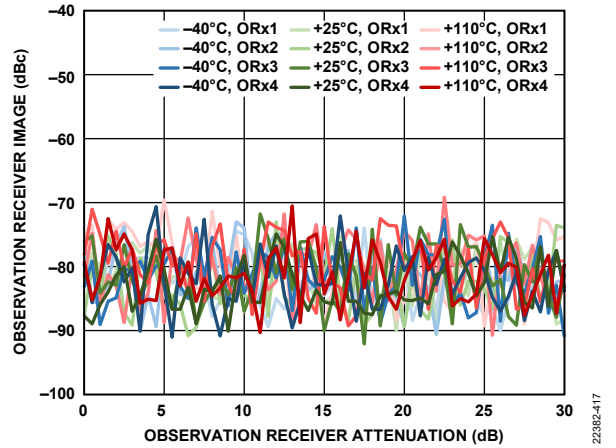

Figure 488. Observation Receiver Image vs. Observation Receiver Attenuation, 45 MHz Offset, Tracking Calibration Active, Sample Rate = 491.52 MSPS

22382-417

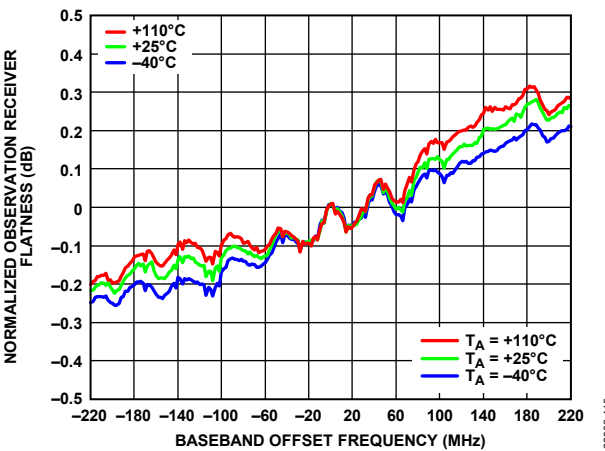

Figure 486. Normalized Observation Receiver Flatness vs. Baseband Offset Frequency, -10 dBFS Input Signal

22382-415

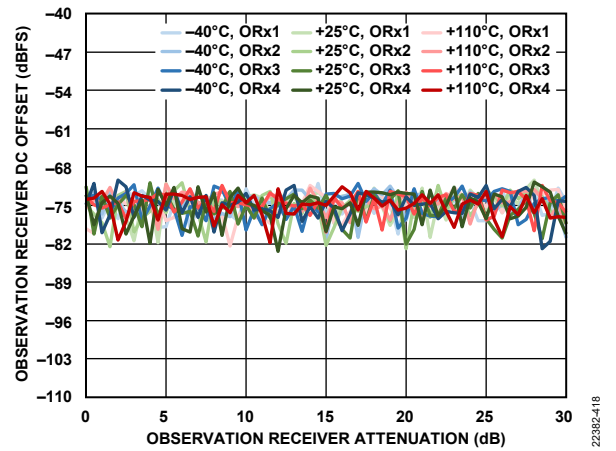

Figure 489. Observation Receiver DC Offset vs. Observation Receiver Attenuation, Sample Rate = 491.52 MSPS

22382-418

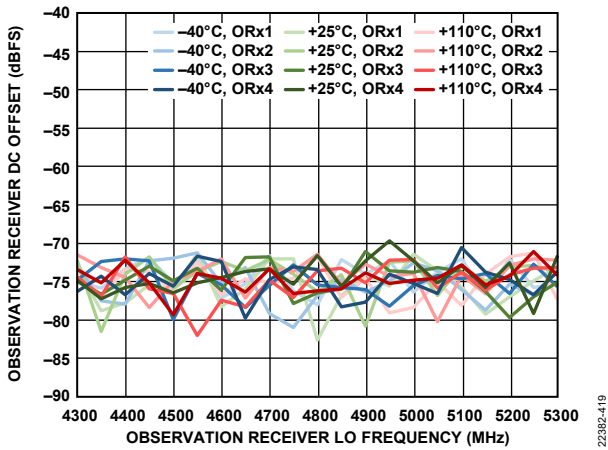

Figure 490. Observation Receiver DC Offset vs. Observation Receiver LO Frequency, Attenuation = 0 dB, Sample Rate = 491.52 MSPS

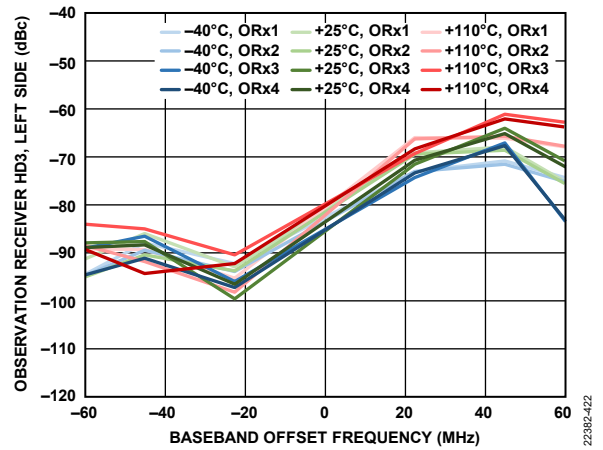

Figure 493. Observation Receiver HD3, Left Side vs. Baseband Offset Frequency, -10 dBFS Input Signal, Distortion Tone Measured Left of 0 Hz

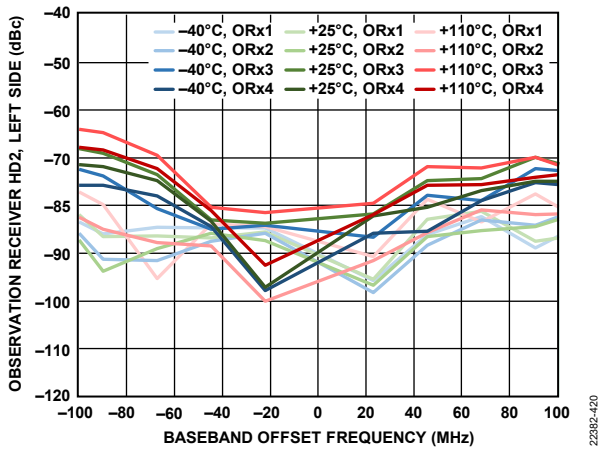

Figure 491. Observation Receiver HD2, Left Side vs. Baseband Offset Frequency, -10 dBFS Input Signal, Distortion Tone Measured Left of 0 Hz

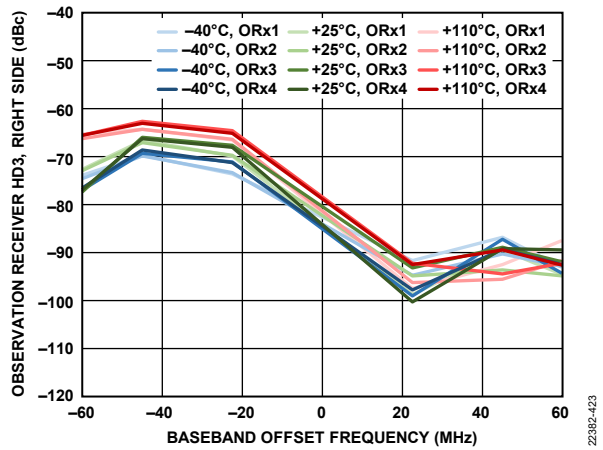

Figure 494. Observation Receiver HD3, Right Side vs. Baseband Offset Frequency, -10 dBFS Input Signal, Distortion Tone Measured Right of 0 Hz

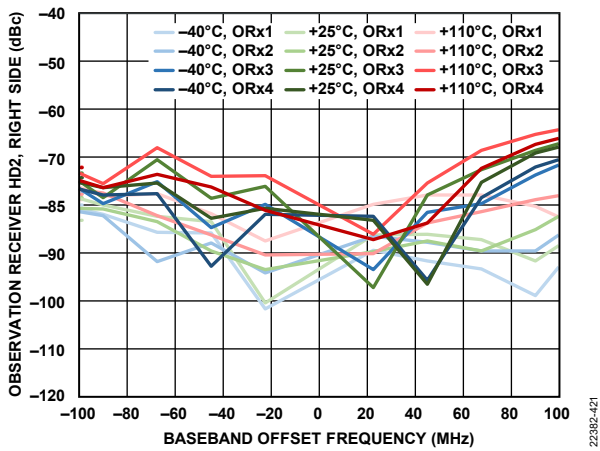

Figure 492. Observation Receiver HD2, Right Side vs. Baseband Offset Frequency, -10 dBFS Input Signal, Distortion Tone Measured Right of 0 Hz

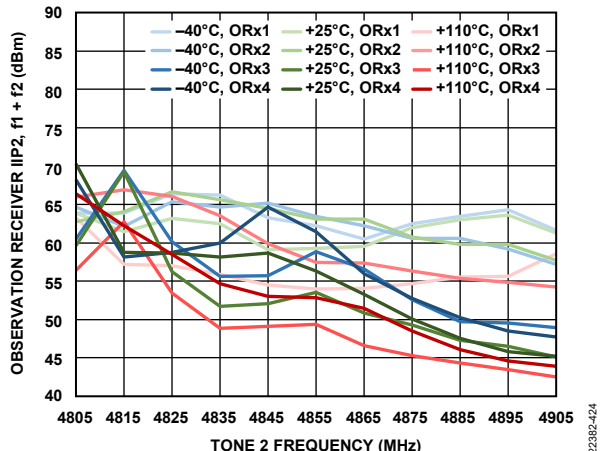

Figure 495. Observation Receiver IIP2, f1 + f2 vs. Tone 2 Frequency, Both Tones at -13 dBFS, f1 = f2 + 2 MHz

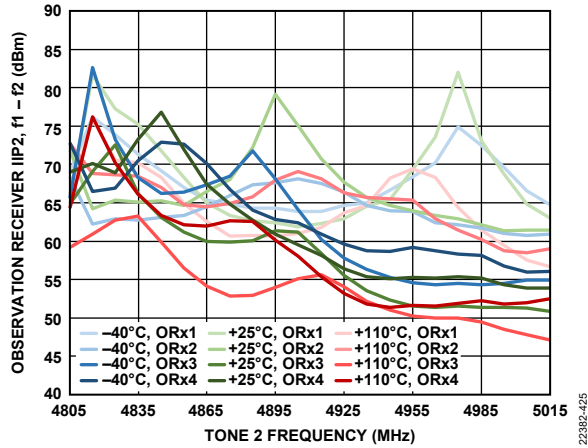

Figure 496. Observation Receiver IIP2,  $f_1 - f_2$  vs. Tone 2 Frequency, Both Tones at  $-13$  dBFS,  $f_1 = f_2 + 2$  MHz

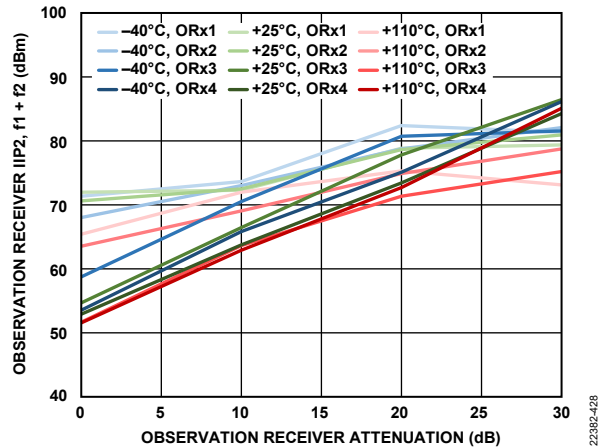

Figure 499. Observation Receiver IIP2,  $f_1 + f_2$  vs. Observation Receiver Attenuation, Both Tones at  $-13$  dBFS,  $f_1 = 102$  MHz,  $f_2 = 2$  MHz

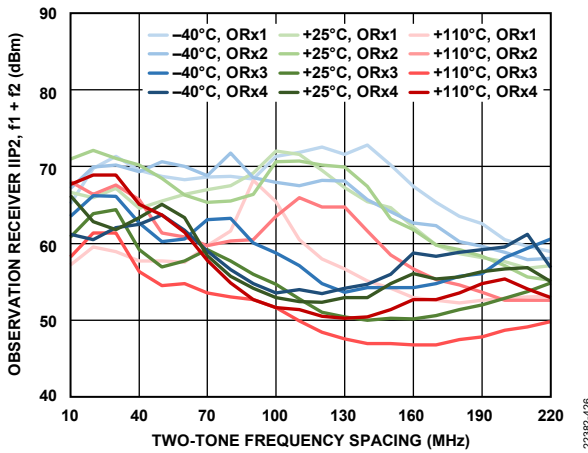

Figure 497. Observation Receiver IIP2,  $f_1 + f_2$  vs. Two-Tone Frequency Spacing, Both Tones at  $-13$  dBFS,  $f_2 = 2$  MHz

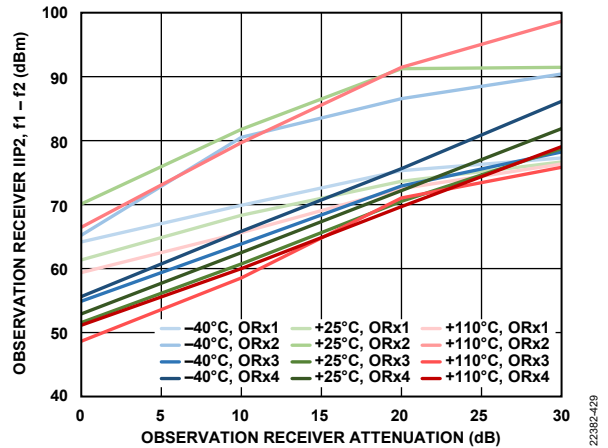

Figure 500. Observation Receiver IIP2,  $f_1 - f_2$  vs. Observation Receiver Attenuation, Both Tones at  $-13$  dBFS,  $f_1 = 102$  MHz,  $f_2 = 2$  MHz

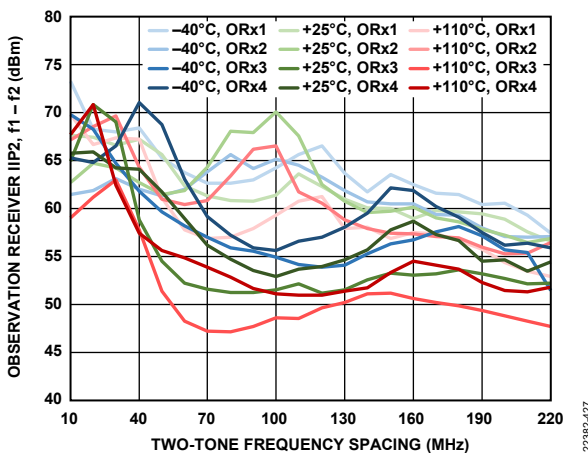

Figure 498. Observation Receiver IIP2,  $f_1 - f_2$  vs. Two-Tone Frequency Spacing, Both Tones at  $-13$  dBFS,  $f_2 = 2$  MHz

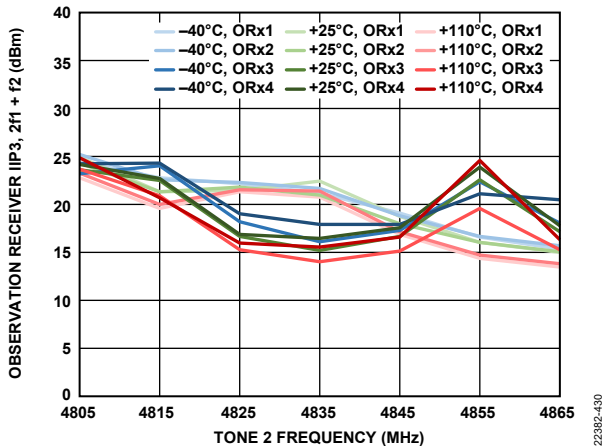
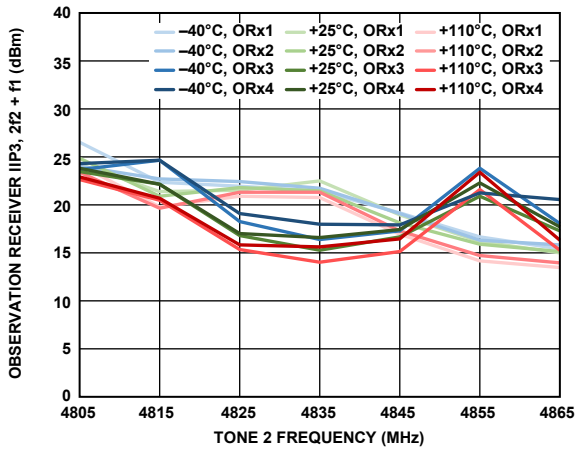
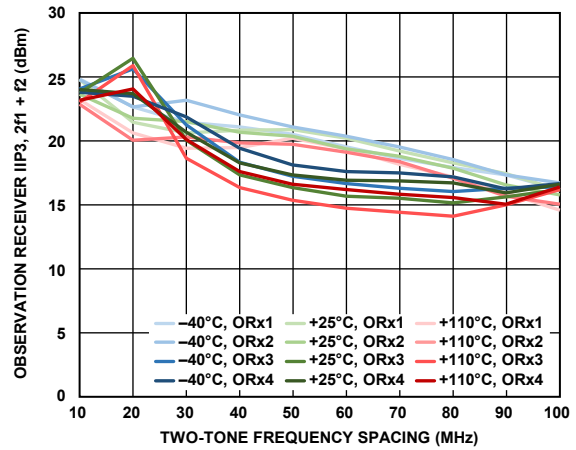

Figure 501. Observation Receiver IIP3,  $2f_1 + f_2$  vs. Tone 2 Frequency, Both Tones at  $-13$  dBFS,  $f_1 = f_2 + 2$  MHz



22382-431

Figure 502. Observation Receiver IIP3, 2f2 + f1 vs. Tone 2 Frequency, Both Tones at -13 dBFS, f1 = f2 + 2 MHz



22382-434

Figure 505. Observation Receiver IIP3, 2f1 + f2 vs. Two-Tone Frequency Spacing, Both Tones at -13 dBFS, f2 = 2 MHz

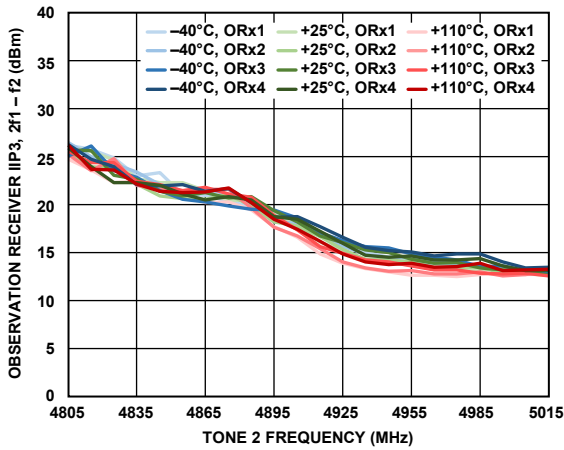

22382-432

Figure 503. Observation Receiver IIP3, 2f1 - f2 vs. Tone 2 Frequency, Both Tones at -13 dBFS, f1 = f2 + 2 MHz

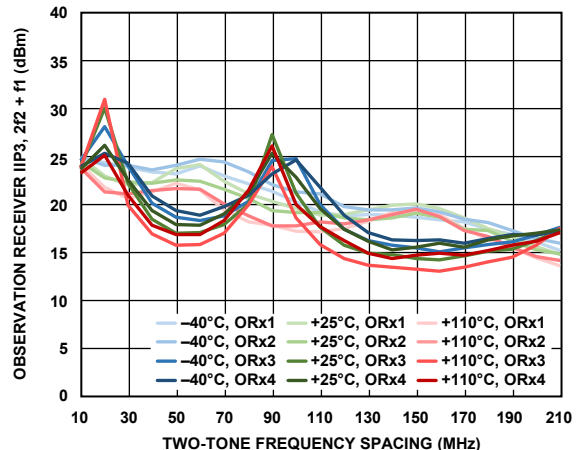

22382-435

Figure 506. Observation Receiver IIP3, 2f2 + f1 vs. Two-Tone Frequency Spacing, Both Tones at -13 dBFS, f2 = 2 MHz

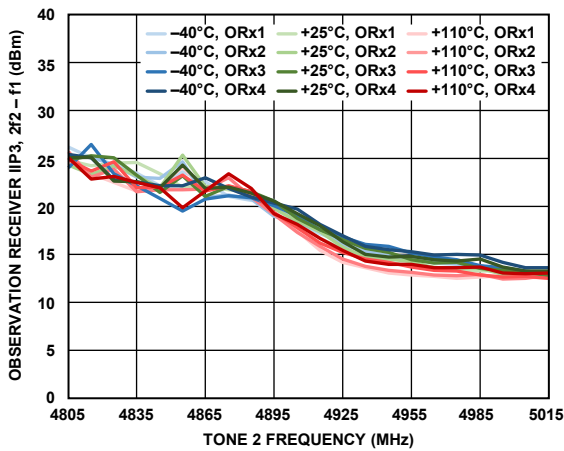

22382-433

Figure 504. Observation Receiver IIP3, 2f2 - f1 vs. Tone 2 Frequency, Both Tones at -13 dBFS, f1 = f2 + 2 MHz

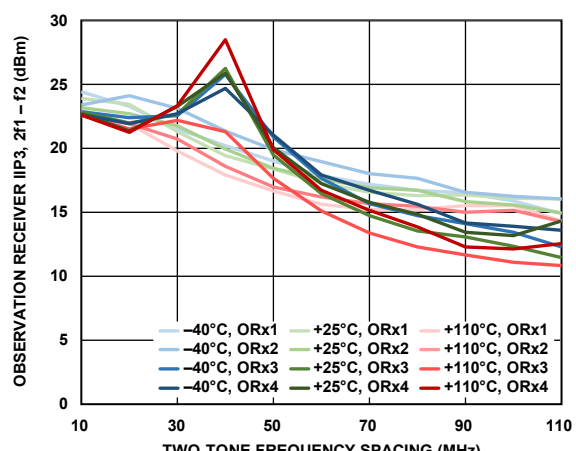

22382-436

Figure 507. Observation Receiver IIP3, 2f1 - f2 vs. Two-Tone Frequency Spacing, Both Tones at -13 dBFS, f2 = 2 MHz

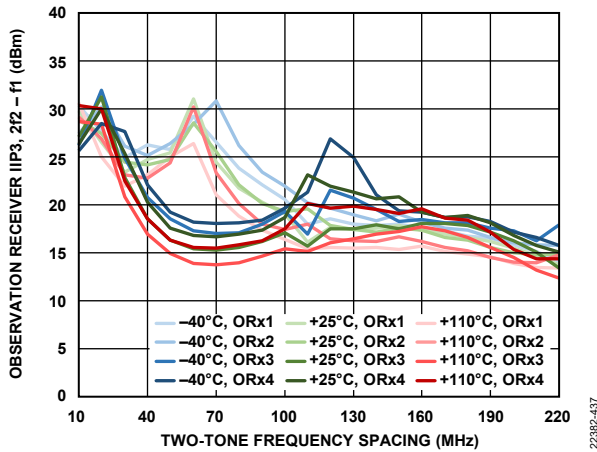

Figure 508. Observation Receiver IIP3,  $2f_2 - f_1$  vs. Two-Tone Frequency Spacing, Both Tones at  $-13$  dBFS,  $f_2 = 2$  MHz

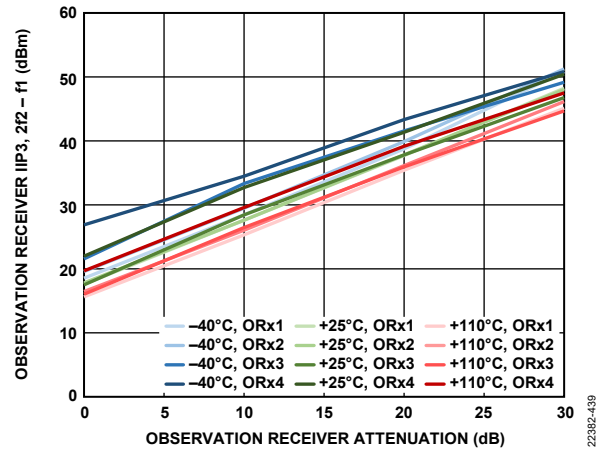

Figure 510. Observation Receiver IIP3,  $2f_2 - f_1$  vs. Observation Receiver Attenuation, Both Tones at  $-13$  dBFS,  $f_1 = 122$  MHz,  $f_2 = 2$  MHz

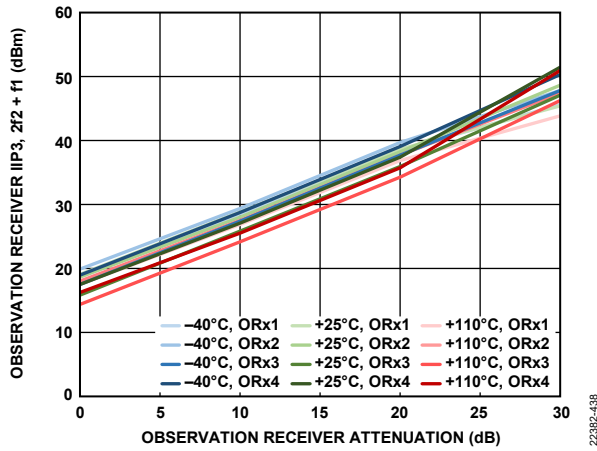

Figure 509. Observation Receiver IIP3,  $2f_2 + f_1$  vs. Observation Receiver Attenuation, Both Tones at  $-13$  dBFS,  $f_1 = 122$  MHz,  $f_2 = 2$  MHz

5700 MHZ BAND

Device configuration profile: receiver = 200 MHz bandwidth, I/Q rate = 245.76 MHz, transmitter = 200 MHz large signal bandwidth plus 450 MHz synthesis bandwidth, I/Q rate = 491.52 MHz, observation receiver (OR<sub>x</sub>) = 450 MHz bandwidth, I/Q rate = 491.52 MHz, device clock = 245.76 MHz, unless otherwise noted. The temperature settings refer to the die temperature. All LO frequencies set to 5700 MHz, unless otherwise noted.

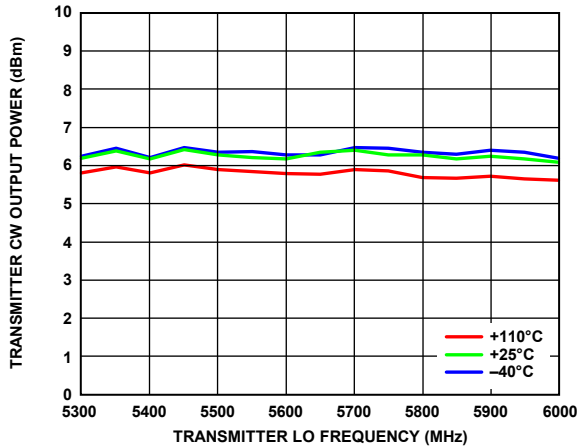

Figure 511. Transmitter Continuous Wave Output Power vs. Transmitter LO Frequency, 10 MHz Offset, 0 dB Attenuation

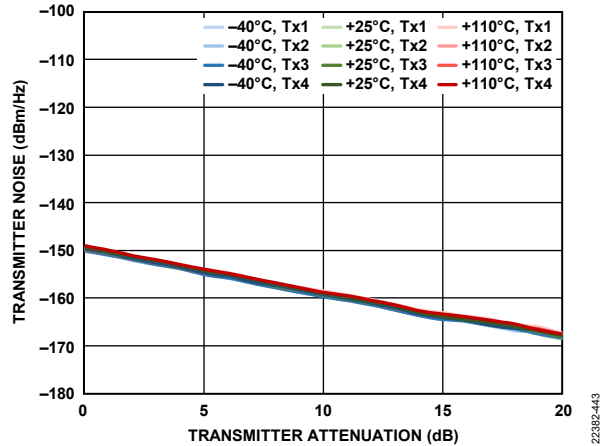

Figure 514. Transmitter Noise vs. Transmitter Attenuation, 10 MHz Offset Frequency

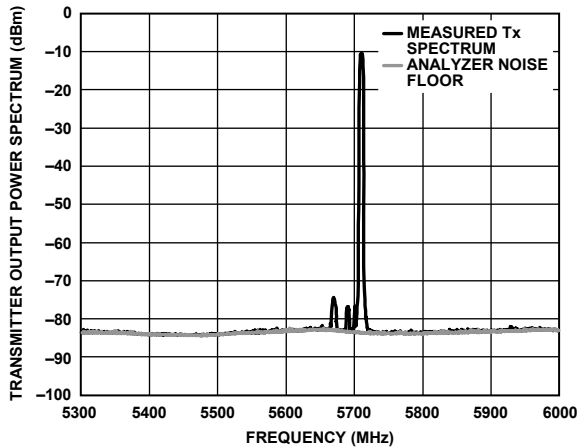

Figure 512. Transmitter Output Power Spectrum, Tx1, 5 MHz LTE, 10 MHz Offset, -10 dBFS RMS, 1 MHz Resolution Bandwidth, T<sub>j</sub> = 25°C

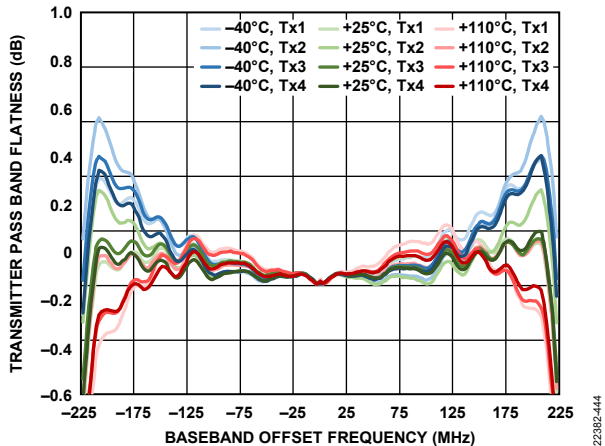

Figure 515. Transmitter Pass Band Flatness vs. Baseband Offset Frequency

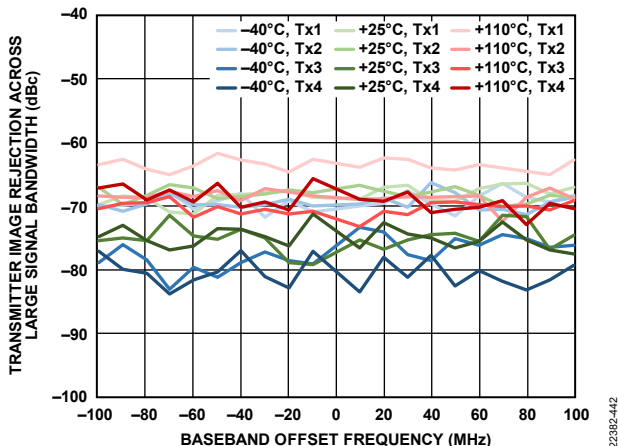

Figure 513. Transmitter Image Rejection Across Large Signal Bandwidth vs. Baseband Offset Frequency

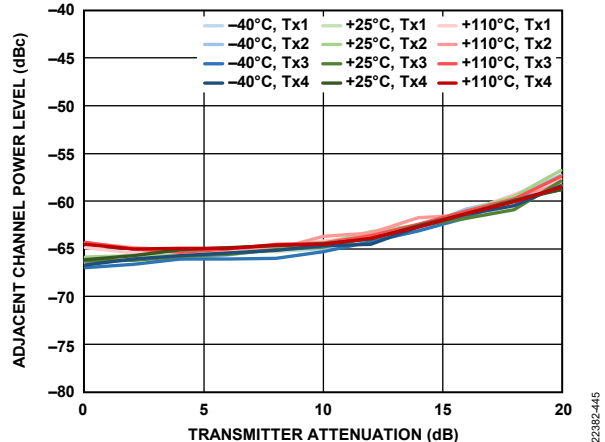

Figure 516. Adjacent Channel Power Level vs. Transmitter Attenuation, -10 MHz Baseband Offset, 20 MHz LTE, PAR = 12 dB



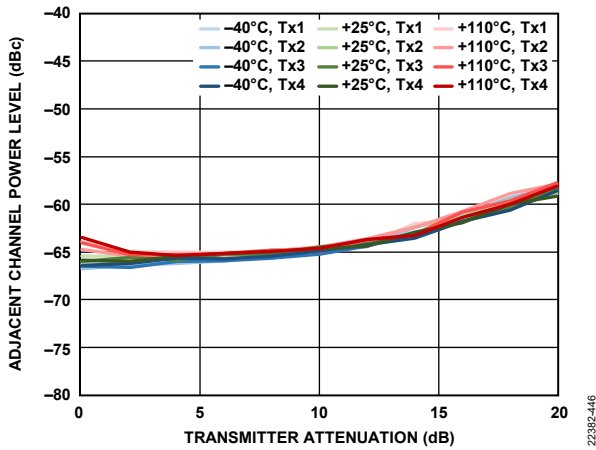

Figure 517. Adjacent Channel Power Level vs. Transmitter Attenuation, 90 MHz Baseband Offset, 20 MHz LTE, PAR = 12 dB

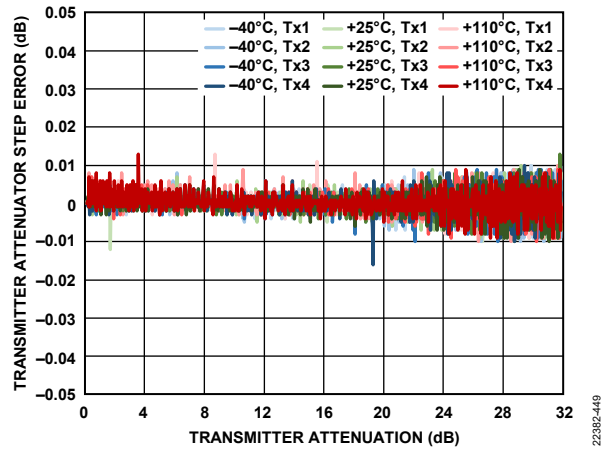

Figure 520. Transmitter Attenuator Step Error vs. Transmitter Attenuation, 10 MHz Offset

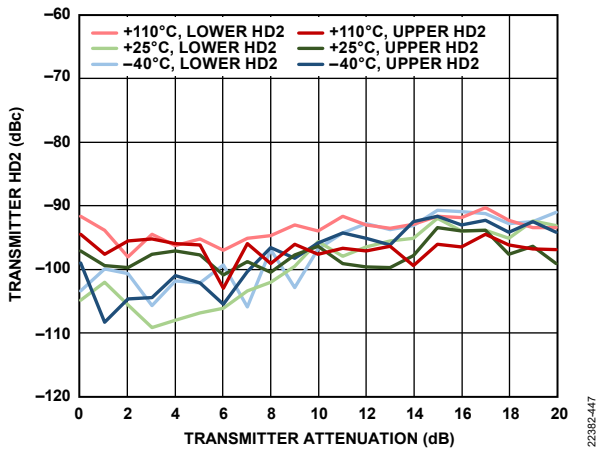

Figure 518. Transmitter Second Harmonic Distortion (HD2) vs. Transmitter Attenuation, 10 MHz Offset

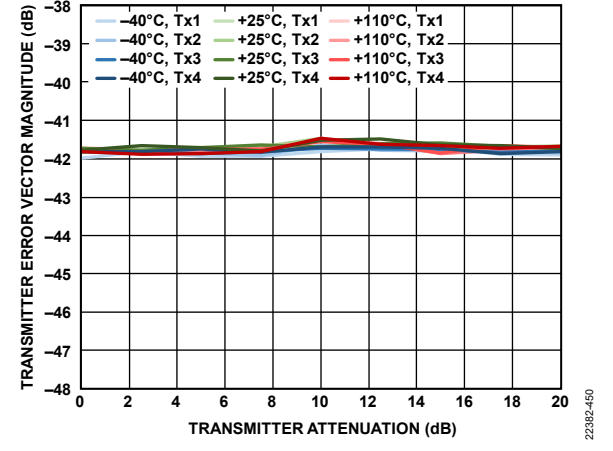

Figure 521. Transmitter Error Vector Magnitude vs. Transmitter Attenuation, 20 MHz LTE Signal Centered at LO Frequency, Sample Rate = 491.52 MSPS, Loop Filter Bandwidth = 400 kHz, Loop Filter Phase Margin = 60°

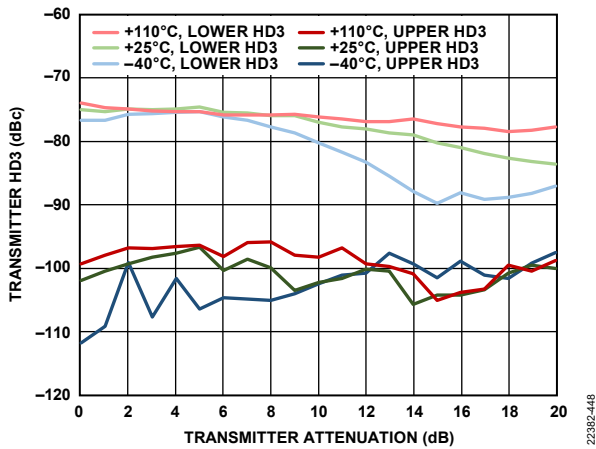

Figure 519. Transmitter Third Harmonic Distortion (HD3) vs. Transmitter Attenuation, 10 MHz Offset

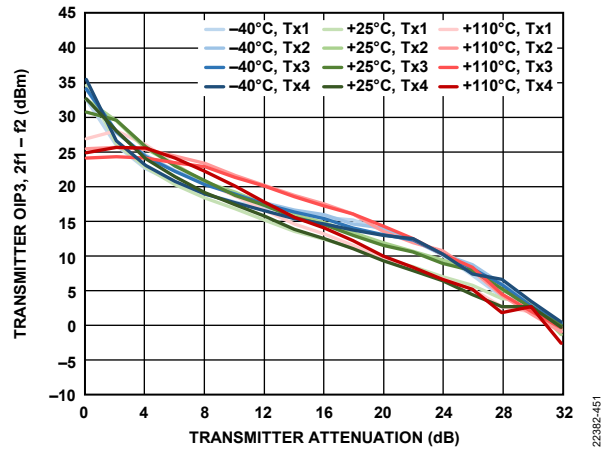

Figure 522. Transmitter OIP3, 2f1 - f2 vs. Transmitter Attenuation, 15 dB Digital Back Off per Tone, f1 = 50.5 MHz, f2 = 55.5 MHz

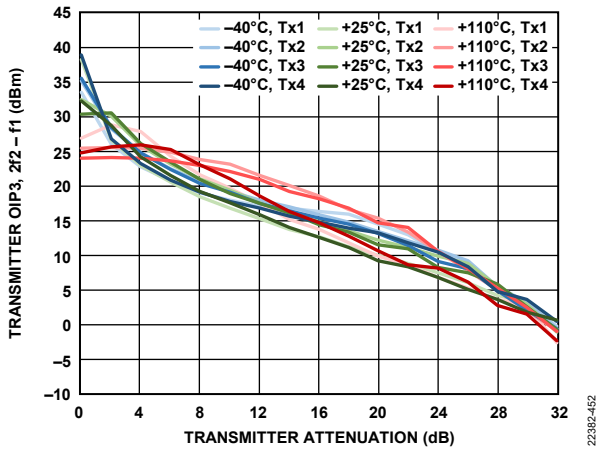

Figure 523. Transmitter OIP3, 2f2 - f1 vs. Transmitter Attenuation, 15 dB Digital Back Off per Tone, f1 = 50.5 MHz, f2 = 55.5 MHz

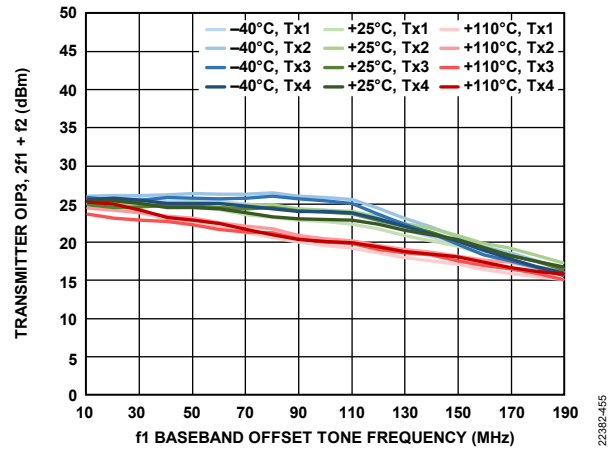

Figure 526. Transmitter OIP3, 2f1 + f2 vs. f1 Baseband Offset Tone Frequency, f2 = f1 + 5 MHz, 15 dB Digital Back Off per Tone

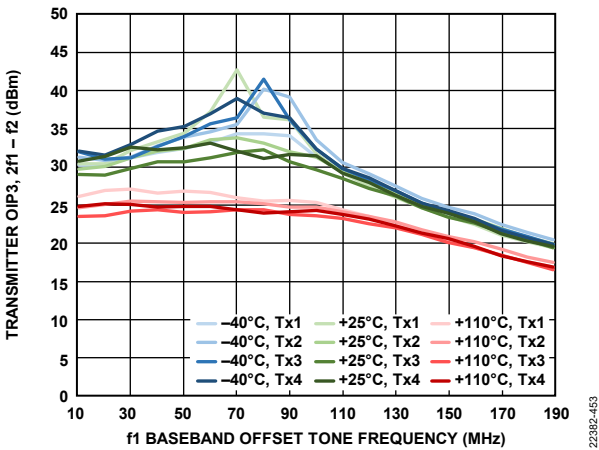

Figure 524. Transmitter OIP3, 2f1 - f2 vs. f1 Baseband Offset Tone Frequency, f2 = f1 + 5 MHz, 15 dB Digital Back Off per Tone

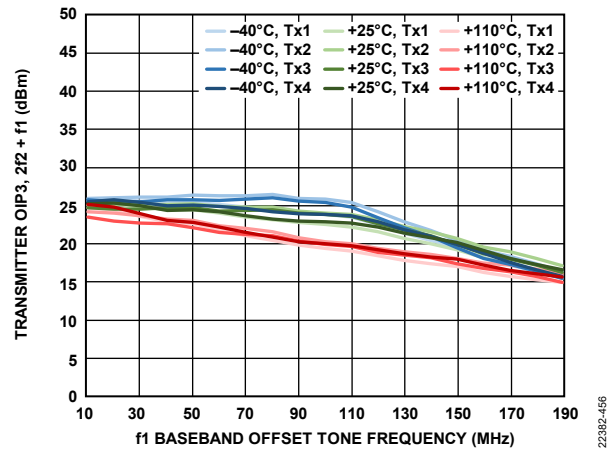

Figure 527. Transmitter OIP3, 2f2 + f1 vs. f1 Baseband Offset Tone Frequency, f2 = f1 + 5 MHz, 15 dB Digital Back Off per Tone

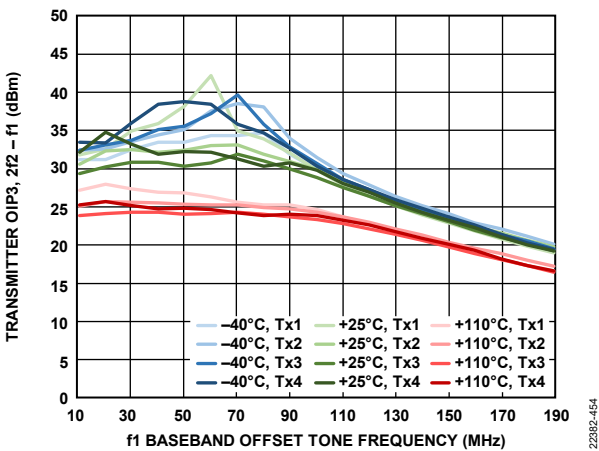

Figure 525. Transmitter OIP3, 2f2 - f1 vs. f1 Baseband Offset Tone Frequency, f2 = f1 + 5 MHz, 15 dB Digital Back Off per Tone

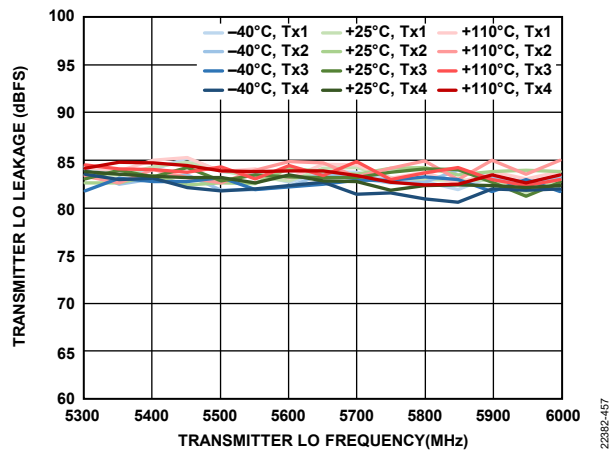

Figure 528. Transmitter LO Leakage vs. Transmitter LO Frequency

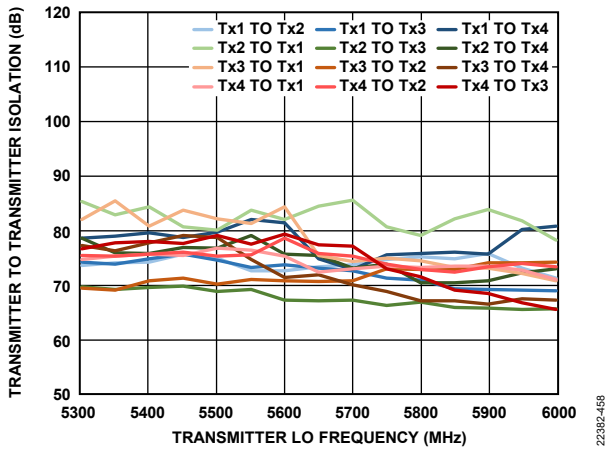

Figure 529. Transmitter to Transmitter Isolation vs. Transmitter LO Frequency

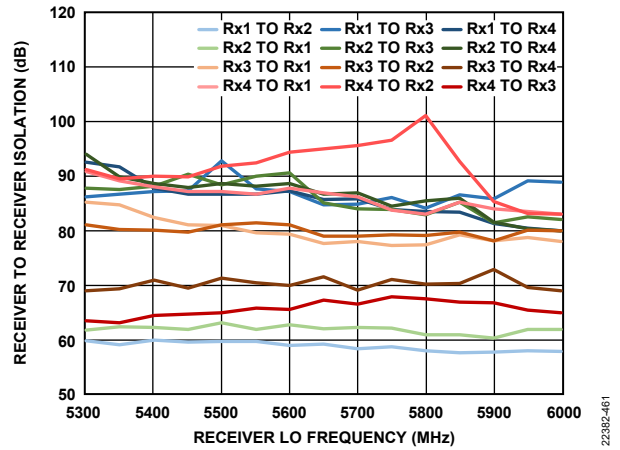

Figure 532. Receiver to Receiver Isolation vs. Receiver LO Frequency

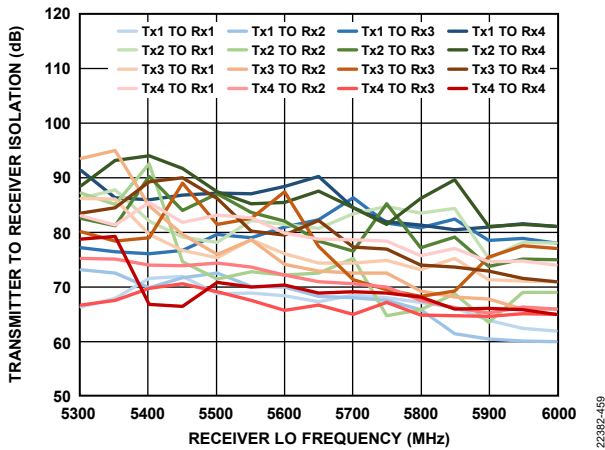

Figure 530. Transmitter to Receiver Isolation vs. Receiver LO Frequency

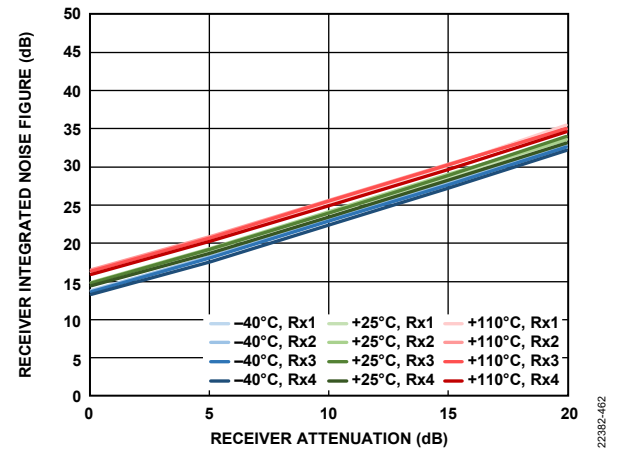

Figure 533. Receiver Integrated Noise Figure vs. Receiver Attenuation, 200 MHz Bandwidth, Sample Rate = 245.76 MSPS, Integration Bandwidth = 500 kHz to 100 MHz

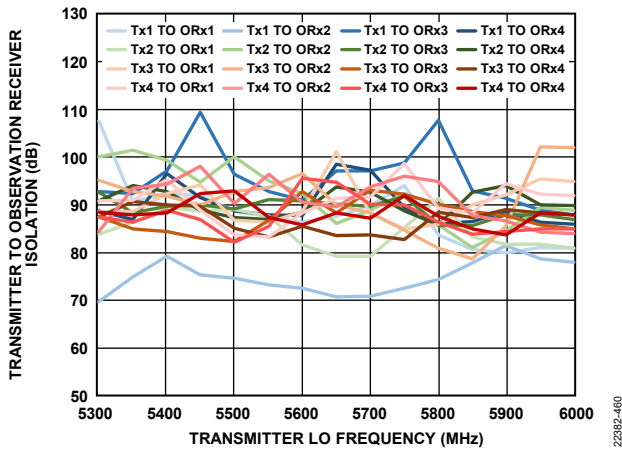

Figure 531. Transmitter to Observation Receiver Isolation vs. Transmitter LO Frequency

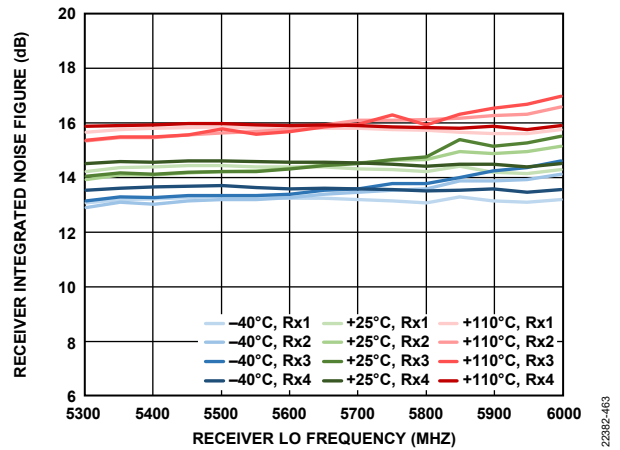

Figure 534. Receiver Integrated Noise Figure vs. Receiver LO Frequency, 200 MHz Bandwidth, Sample Rate = 245.76 MSPS, Integration Bandwidth = 500 kHz to 100 MHz

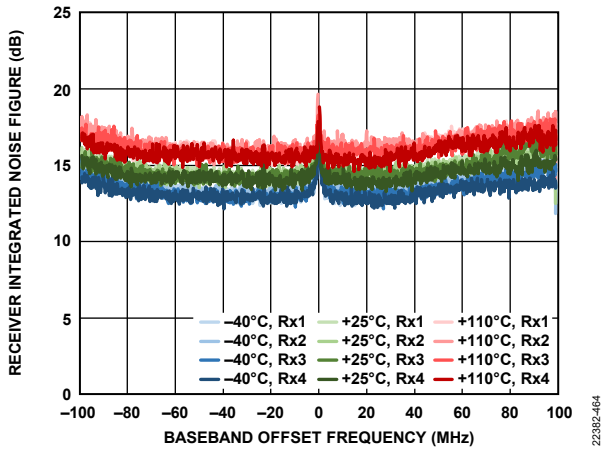

Figure 535. Receiver Integrated Noise Figure vs. Baseband Offset Frequency, 200 MHz Bandwidth, Sample Rate = 245.76 MSPS, Integrated in 200 kHz Steps

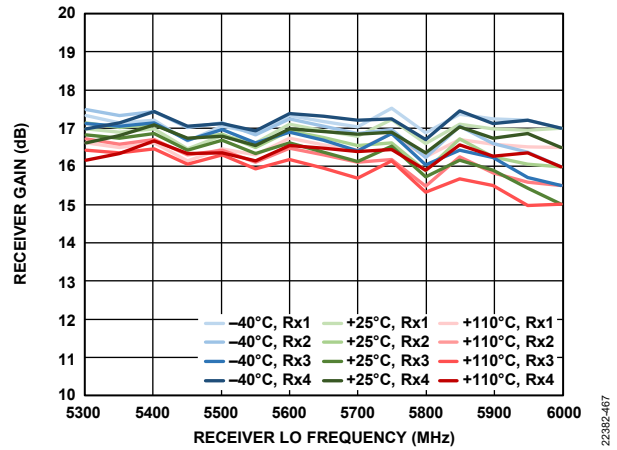

Figure 538. Receiver Gain vs. Receiver LO Frequency, 200 MHz Bandwidth, Sample Rate = 245.76 MSPS

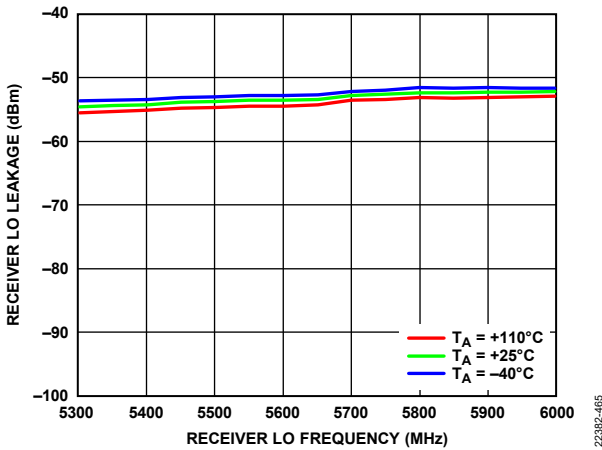

Figure 536. Receiver LO Leakage vs. Receiver LO Frequency, Attenuation = 0 dB, Sample Rate = 245.76 MSPS

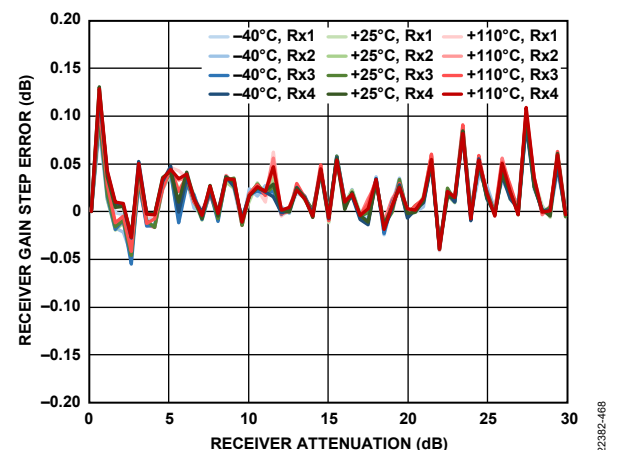

Figure 539. Receiver Gain Step Error vs. Receiver Attenuation, 20 MHz Offset, -5 dBFS Input Signal

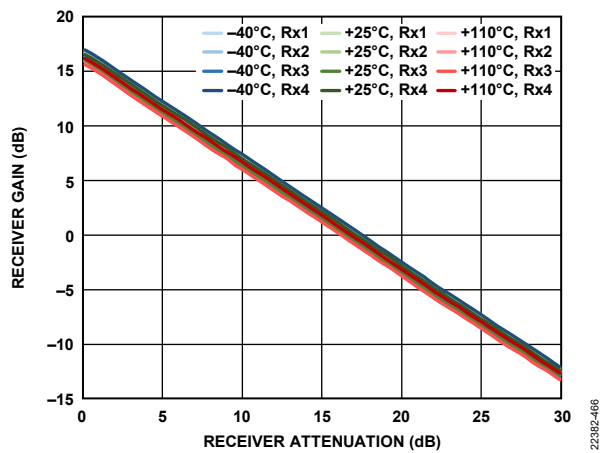

Figure 537. Receiver Gain vs. Receiver Attenuation, 20 MHz Offset, 200 MHz Bandwidth, Sample Rate = 245.76 MSPS

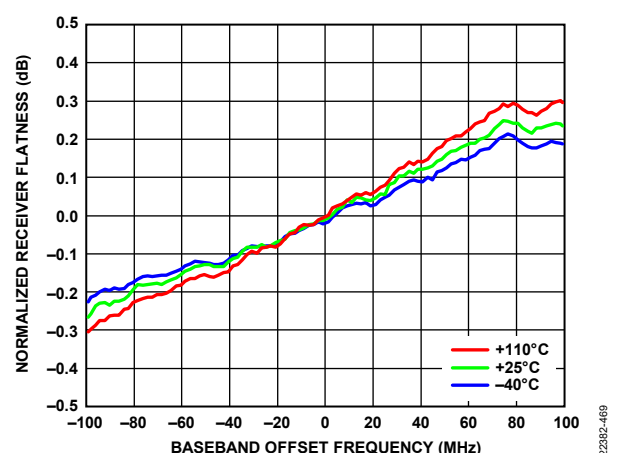

Figure 540. Normalized Receiver Flatness vs. Baseband Offset Frequency, -5 dBFS Input Signal

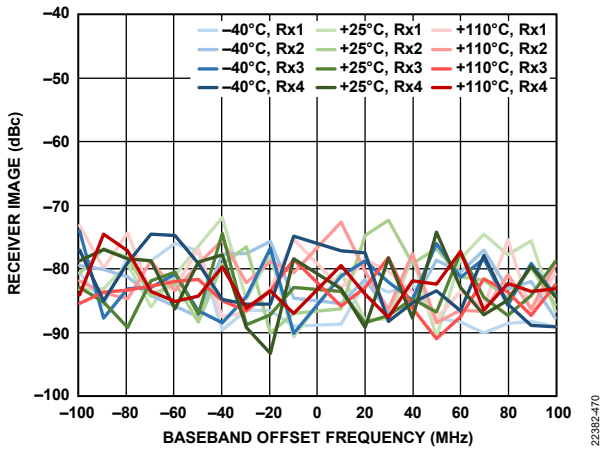

Figure 541. Receiver Image vs. Baseband Offset Frequency, Tracking Calibration Active, Sample Rate = 245.76 MSPS

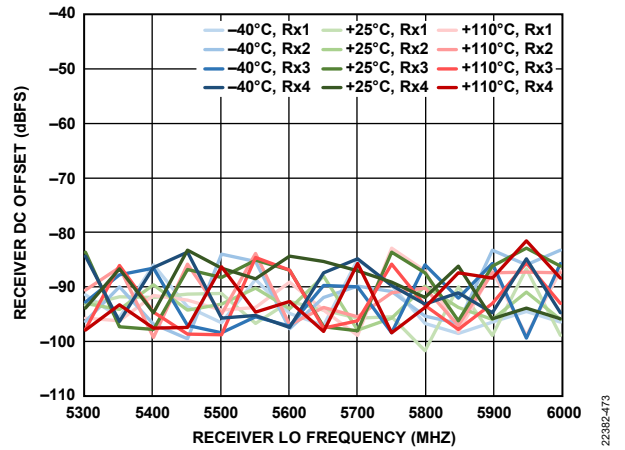

Figure 544. Receiver DC Offset vs. Receiver LO Frequency, Attenuation = 0 dB, Sample Rate = 245.76 MSPS

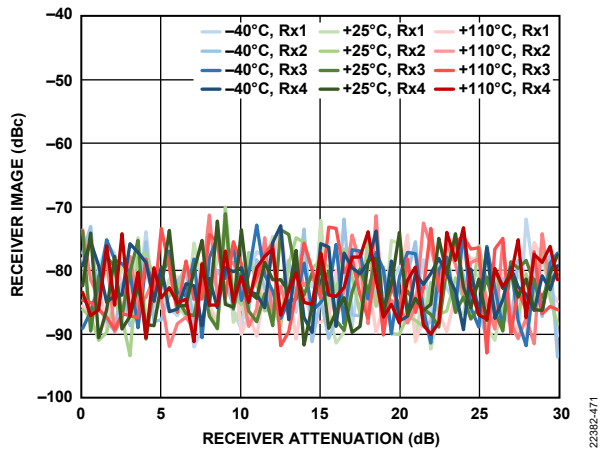

Figure 542. Receiver Image vs. Receiver Attenuation, 20 MHz Offset, Tracking Calibration Active, Sample Rate = 245.76 MSPS

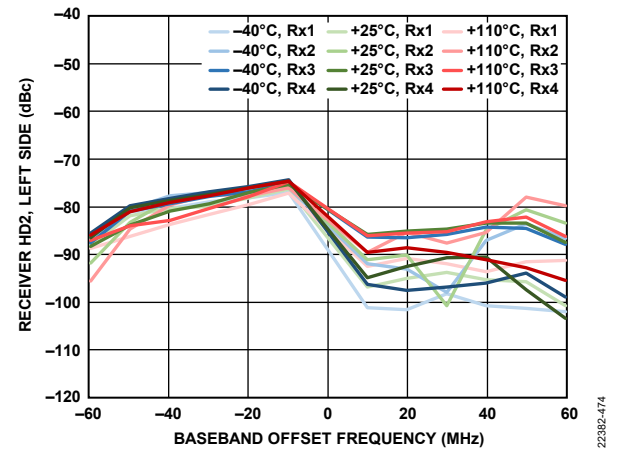

Figure 545. Receiver HD2, Left Side vs. Baseband Offset Frequency, -5 dBFS Input Signal, Distortion Tone Measured Left of 0 Hz (HD2 Canceller Not Enabled)

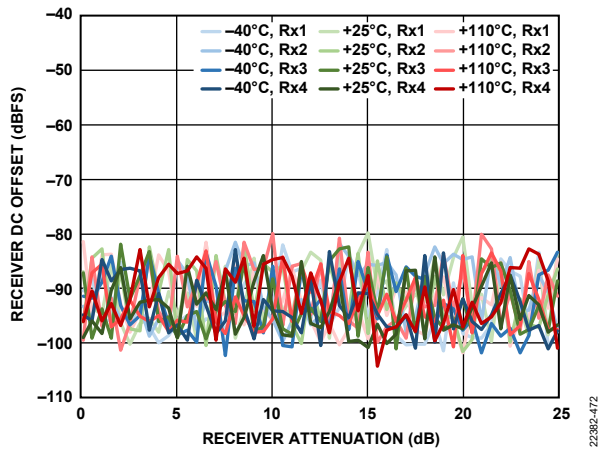

Figure 543. Receiver DC Offset vs. Receiver Attenuation, 20 MHz Offset, -5 dBFS Input Signal, Sample Rate = 245.76 MSPS

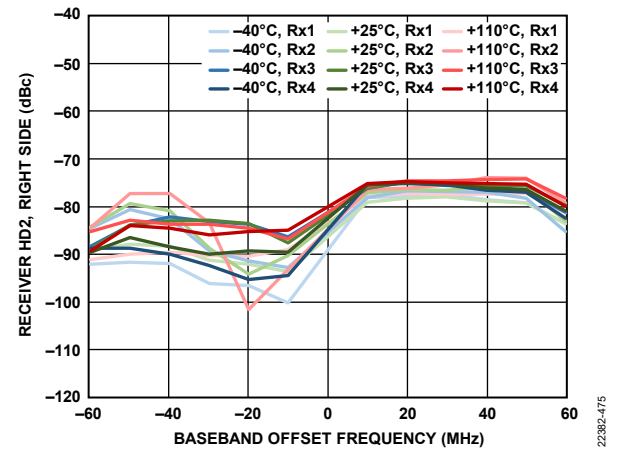

Figure 546. Receiver HD2, Right Side vs. Baseband Offset Frequency, -5 dBFS Input Signal, Distortion Tone Measured Right of 0 Hz (HD2 Canceller Not Enabled)

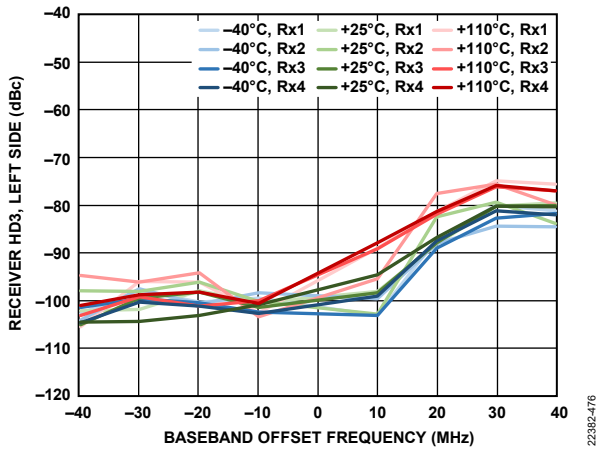

Figure 547. Receiver HD3, Left Side vs. Baseband Offset Frequency, -5 dBFS Input Signal, Distortion Tone Measured Left of 0 Hz

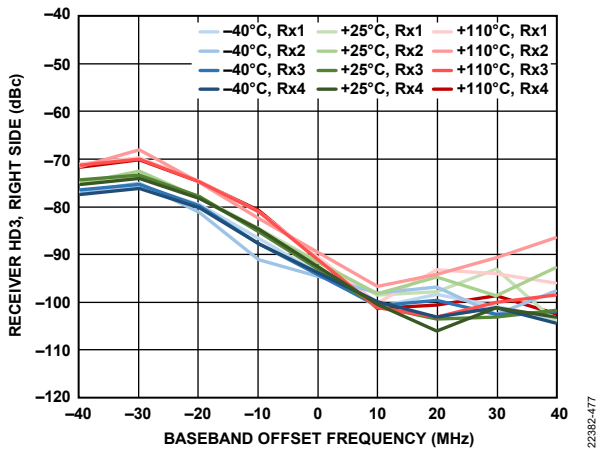

Figure 548. Receiver HD3, Right Side vs. Baseband Offset Frequency, -5 dBFS Input Signal, Distortion Tone Measured Right of 0 Hz

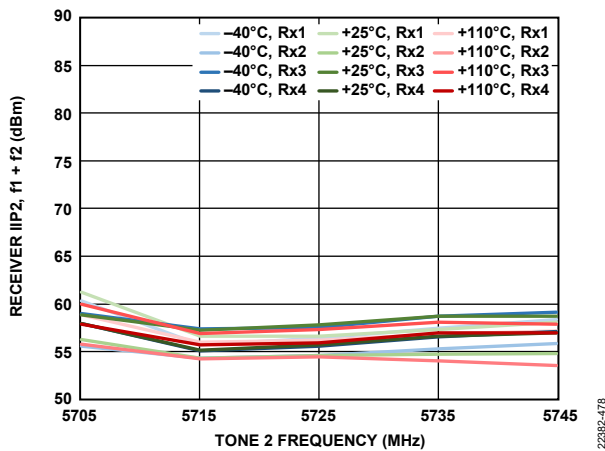

Figure 549. Receiver IIP2,  $f_1 + f_2$  vs. Tone 2 Frequency, Both Tones at -11 dBFS,  $f_1 = f_2 + 2$  MHz

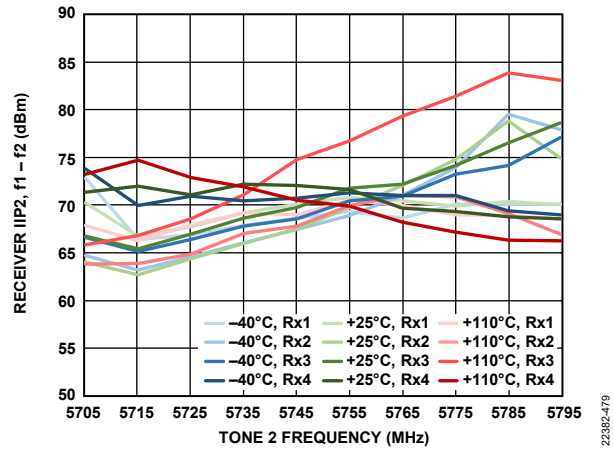

Figure 550. Receiver IIP2,  $f_1 - f_2$  vs. Tone 2 Frequency, Both Tones at -11 dBFS,  $f_1 = f_2 + 2$  MHz

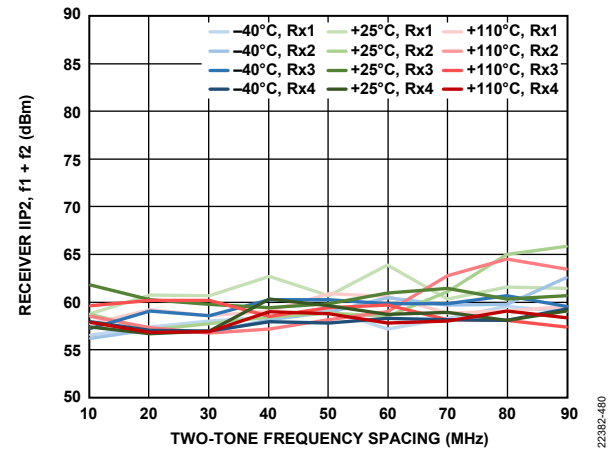

Figure 551. Receiver IIP2,  $f_1 + f_2$  vs. Two-Tone Frequency Spacing, Both Tones at -11 dBFS,  $f_2 = 2$  MHz

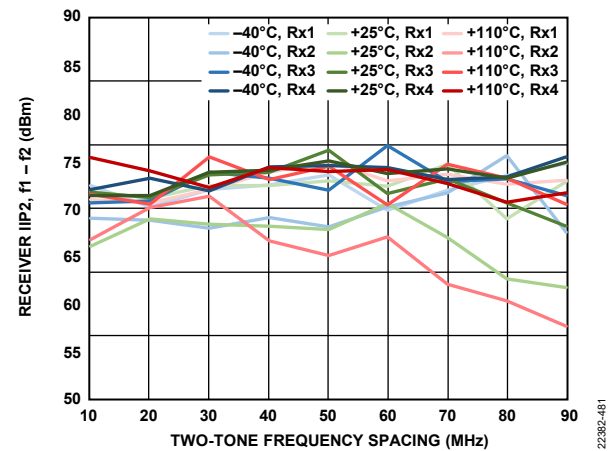

Figure 552. Receiver IIP2,  $f_1 - f_2$  vs. Two-Tone Frequency Spacing, Both Tones at -11 dBFS,  $f_2 = 2$  MHz

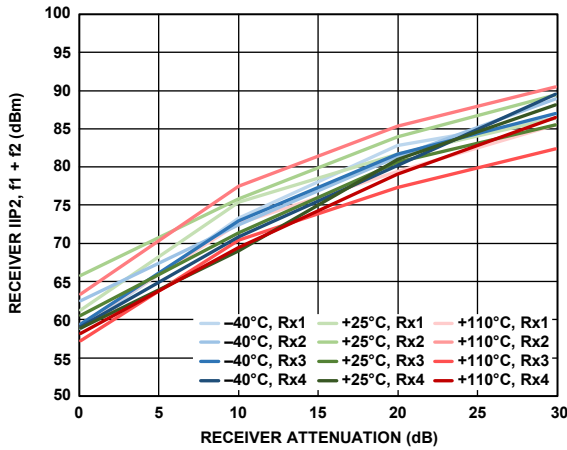

Figure 553. Receiver IIP2,  $f_1 + f_2$  vs. Receiver Attenuation, Both Tones at  $-11$  dBFS,  $f_1 = 92$  MHz,  $f_2 = 2$  MHz

22382-482

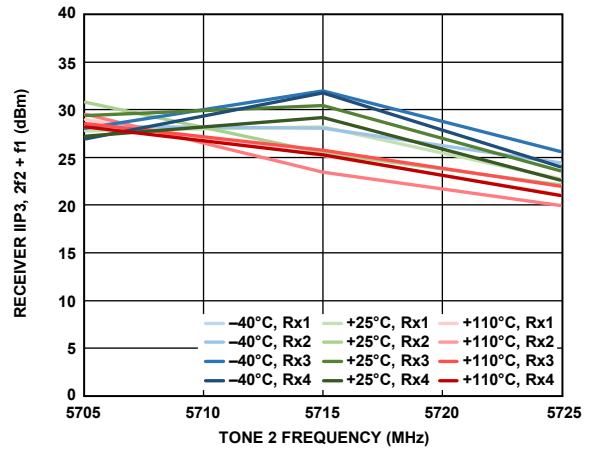

Figure 556. Receiver IIP3,  $2f_2 + f_1$  vs. Tone 2 Frequency, Both Tones at  $-11$  dBFS,  $f_1 = f_2 + 2$  MHz

22382-485

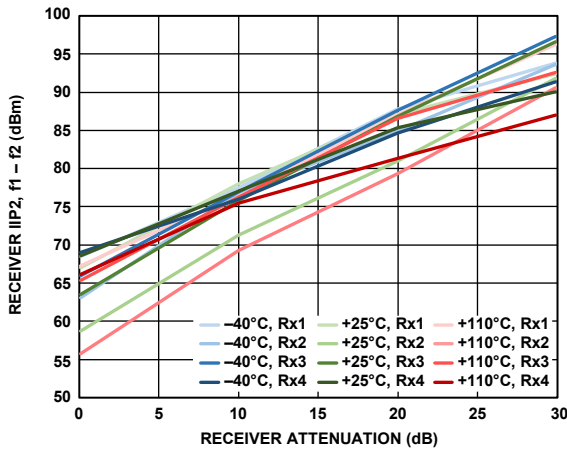

Figure 554. Receiver IIP2,  $f_1 - f_2$  vs. Receiver Attenuation, Both Tones at  $-11$  dBFS,  $f_1 = 92$  MHz,  $f_2 = 2$  MHz

22382-483

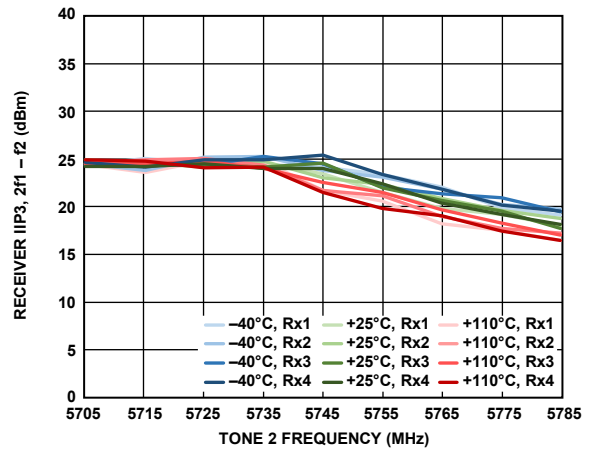

Figure 557. Receiver IIP3,  $2f_1 - f_2$  vs. Tone 2 Frequency, Both Tones at  $-11$  dBFS,  $f_1 = f_2 + 2$  MHz

22382-486

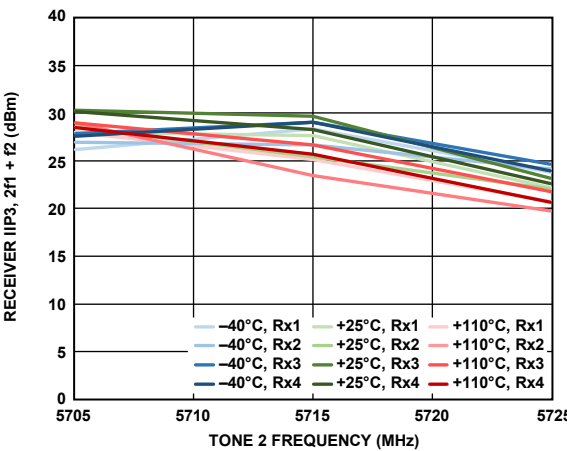

Figure 555. Receiver IIP3,  $2f_1 + f_2$  vs. Tone 2 Frequency, Both Tones at  $-11$  dBFS,  $f_1 = f_2 + 2$  MHz

22382-484

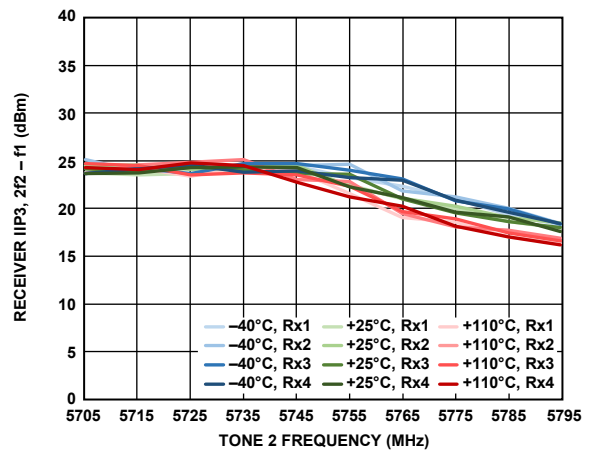

Figure 558. Receiver IIP3,  $2f_2 - f_1$  vs. Tone 2 Frequency, Both Tones at  $-11$  dBFS,  $f_1 = f_2 + 2$  MHz

22382-487

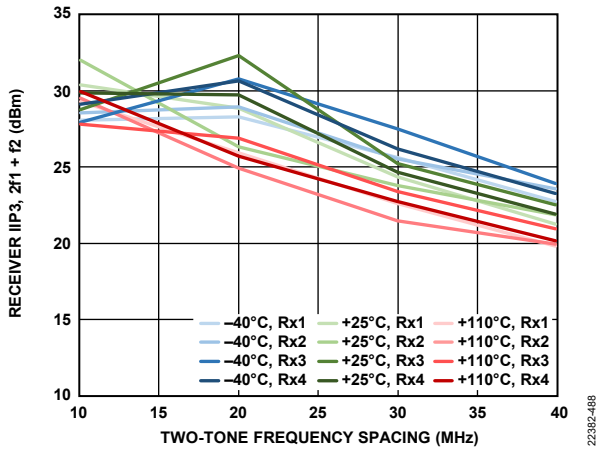

Figure 559. Receiver IIP3, 2f1 + f2 vs. Two-Tone Frequency Spacing, Both Tones at -11 dBFS, f2 = 2 MHz

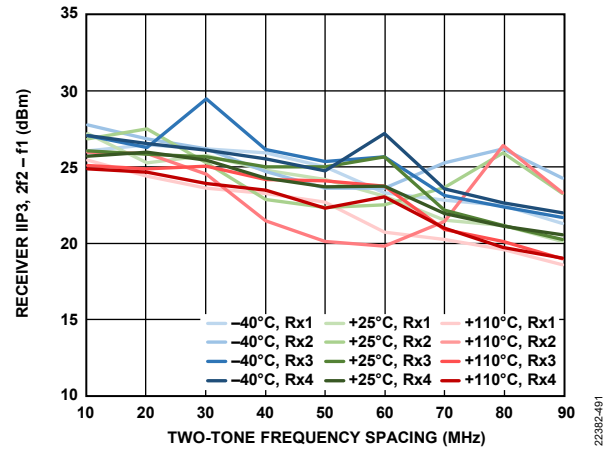

Figure 562. Receiver IIP3, 2f2 - f1 vs. Two-Tone Frequency Spacing, Both Tones at -11 dBFS, f2 = 2 MHz

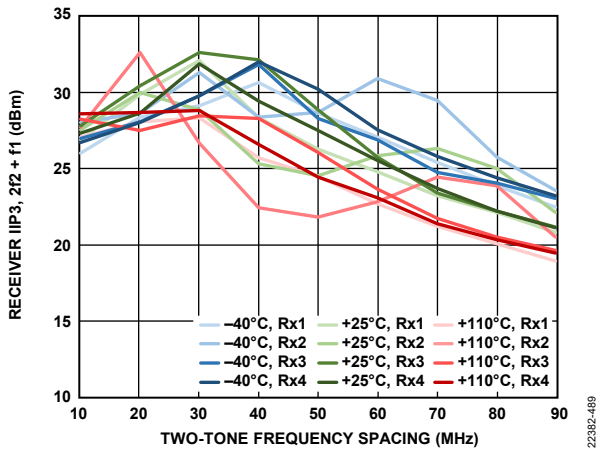

Figure 560. Receiver IIP3, 2f2 + f1 vs. Two-Tone Frequency Spacing, Both Tones at -11 dBFS, f2 = 2 MHz

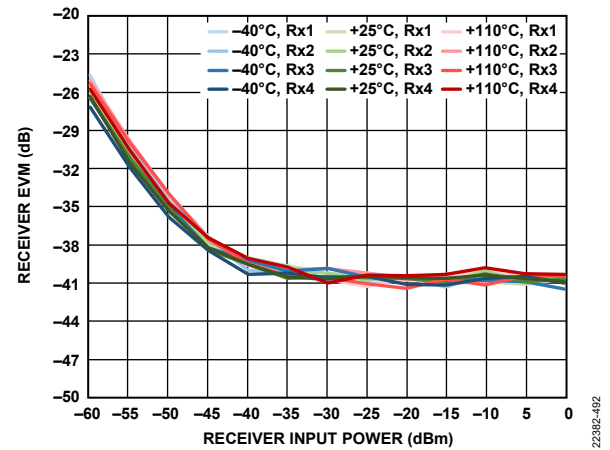

Figure 563. Receiver Error Vector Magnitude vs. Receiver Input Power, 20 MHz LTE Signal Centered at LO Frequency, Sample Rate = 245.76 MSPS, Loop Filter Bandwidth = 400 kHz, Loop Filter Phase Margin = 60°

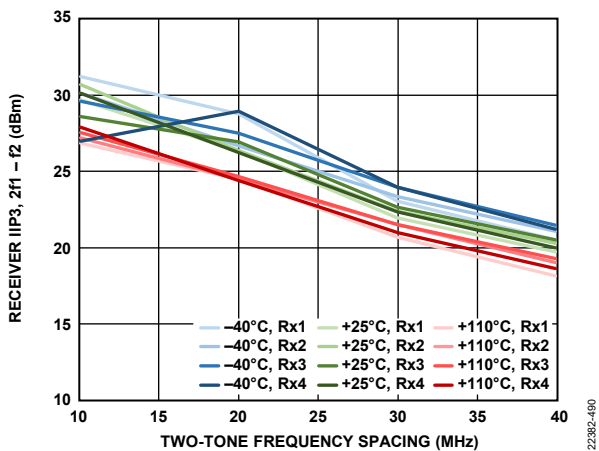

Figure 561. Receiver IIP3, 2f1 - f2 vs. Two-Tone Frequency Spacing, Both Tones at -11 dBFS, f2 = 2 MHz

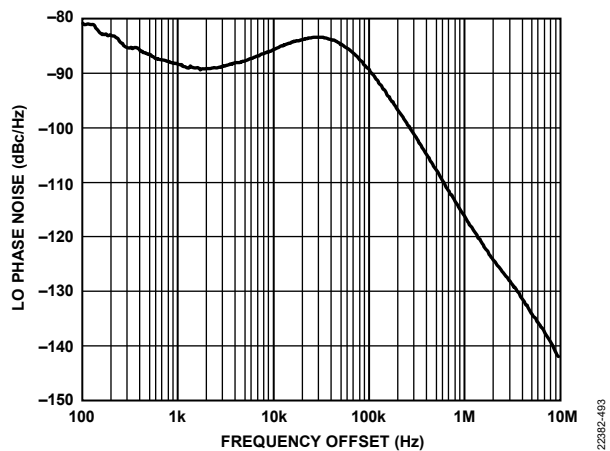

Figure 564. LO Phase Noise vs. Frequency Offset, Loop Bandwidth = 75 kHz, Phase Margin = 85°



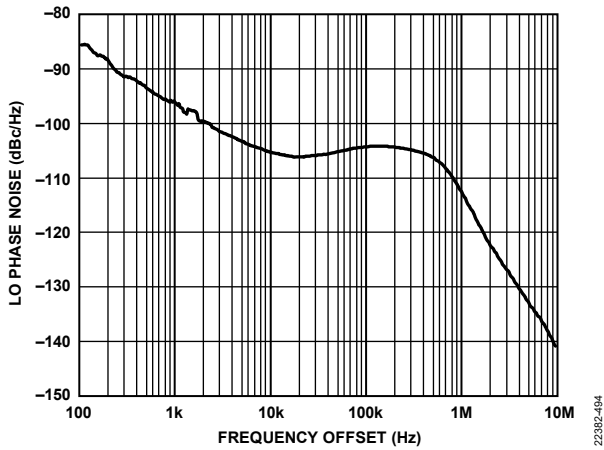

Figure 565. LO Phase Noise vs. Frequency Offset, Loop Bandwidth = 500 kHz, Phase Margin = 60°

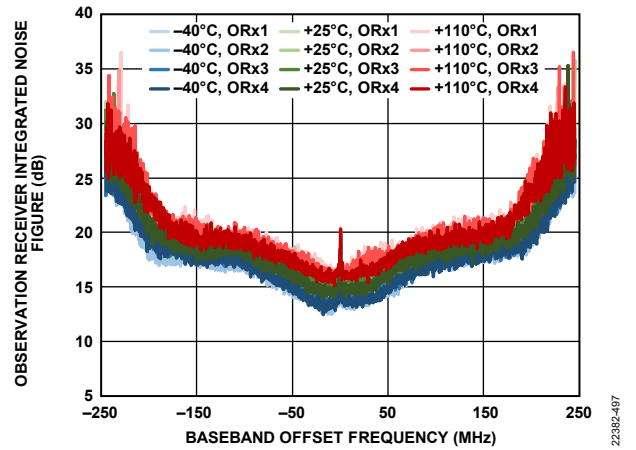

Figure 568. Observation Receiver Integrated Noise Figure vs. Baseband Offset Frequency, 450 MHz Bandwidth, Sample Rate = 491.52 MSPS, Integrated in 200 kHz Steps

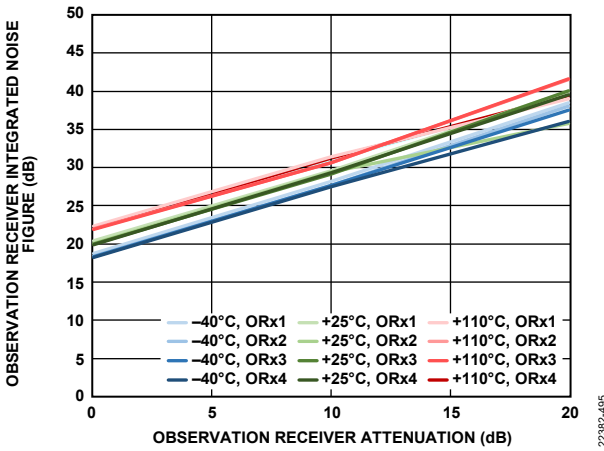

Figure 566. Observation Receiver Integrated Noise Figure vs. Observation Receiver Attenuation, 450 MHz Bandwidth, Sample Rate = 491.52 MSPS, Integration Bandwidth = 500 kHz to 245.76 MHz

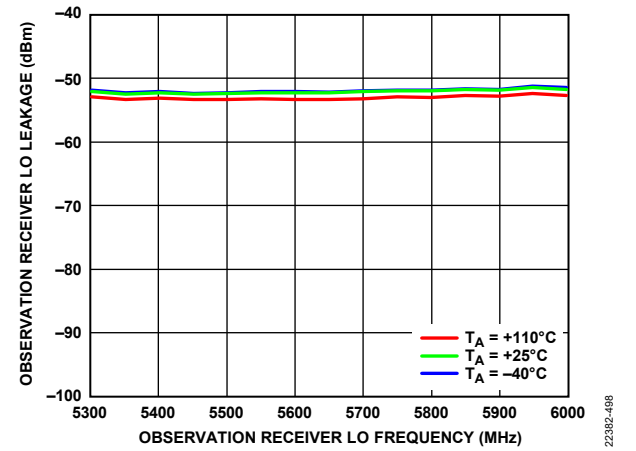

Figure 569. Observation Receiver LO Leakage vs. Observation Receiver LO Frequency, Attenuation = 0 dB, Sample Rate = 491.52 MSPS

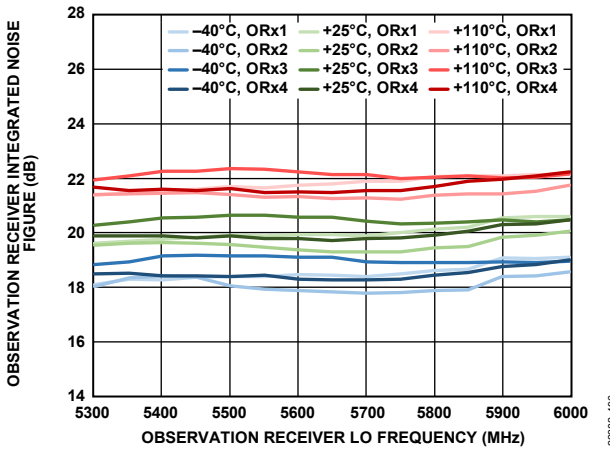

Figure 567. Observation Receiver Integrated Noise Figure vs. Observation Receiver LO Frequency, 450 MHz Bandwidth, Sample Rate = 491.52 MSPS, Integration Bandwidth = 500 kHz to 245.76 MHz

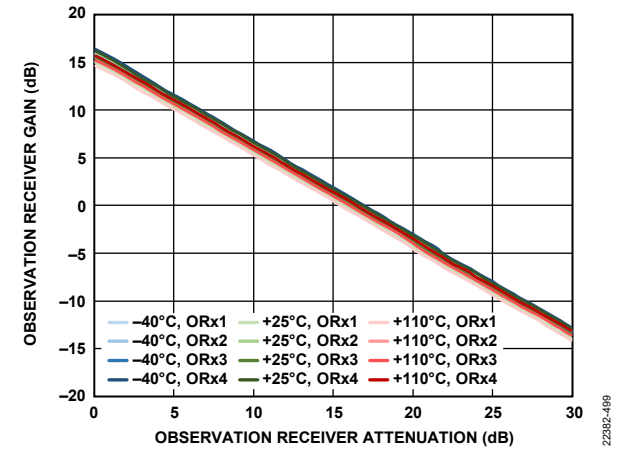

Figure 570. Observation Receiver Gain vs. Observation Receiver Attenuation, 45 MHz Offset, 450 MHz Bandwidth, Sample Rate = 491.52 MSPS

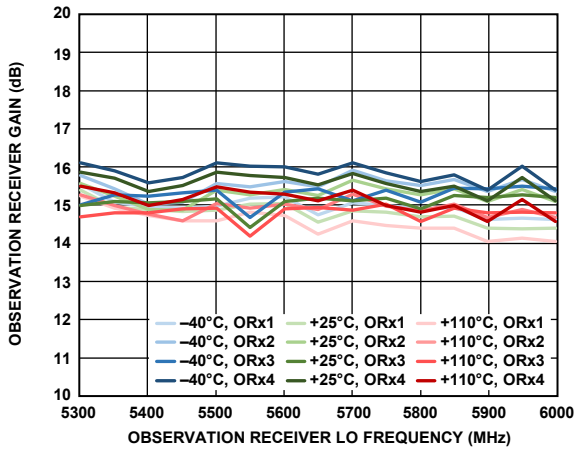

Figure 571. Observation Receiver Gain vs. Observation Receiver LO Frequency, 450 MHz Bandwidth, Sample Rate = 491.52 MSPS

22382-500

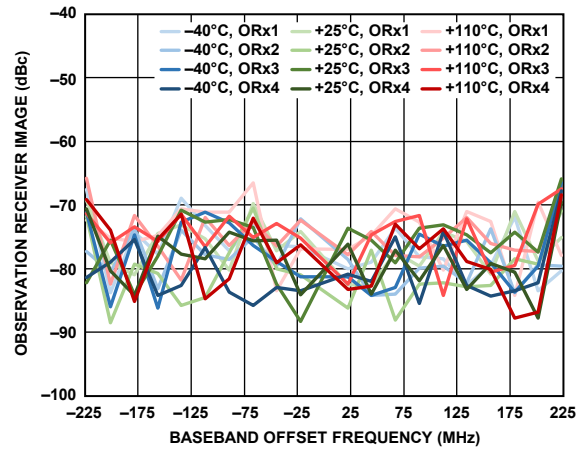

Figure 574. Observation Receiver Image vs. Baseband Offset Frequency, Tracking Calibration Active, Sample Rate = 491.52 MSPS

22382-503

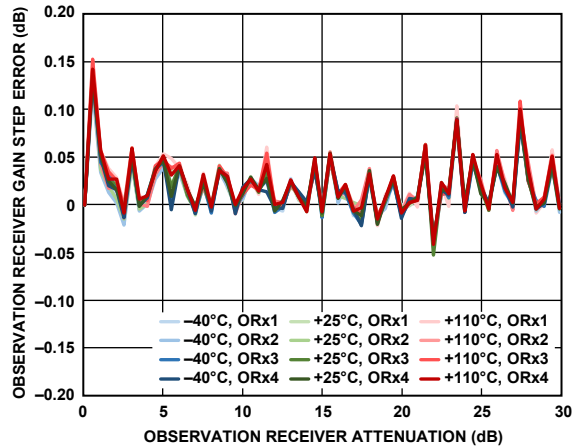

Figure 572. Observation Receiver Gain Step Error vs. Observation Receiver Attenuation, 45 MHz Offset, -10 dBFS Input Signal

22382-501

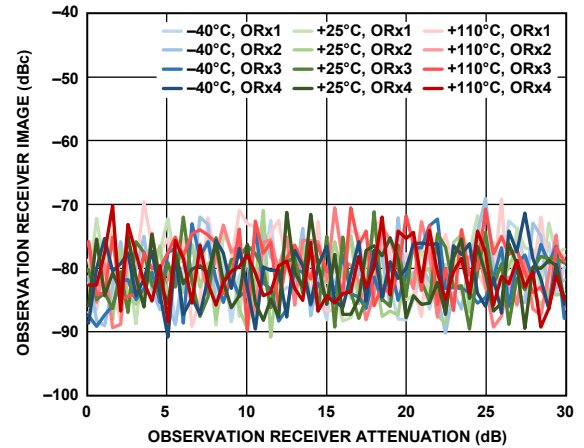

Figure 575. Observation Receiver Image vs. Observation Receiver Attenuation, 20 MHz Offset, Tracking Calibration Active, Sample Rate = 491.52 MSPS

22382-504

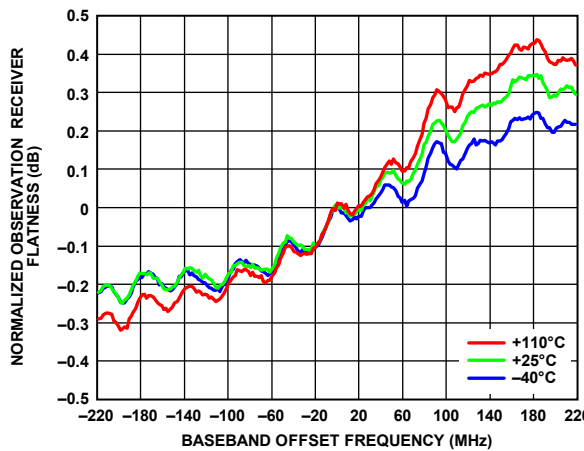

Figure 573. Normalized Observation Receiver Flatness vs. Baseband Offset Frequency, -10 dBFS Input Signal

22382-502

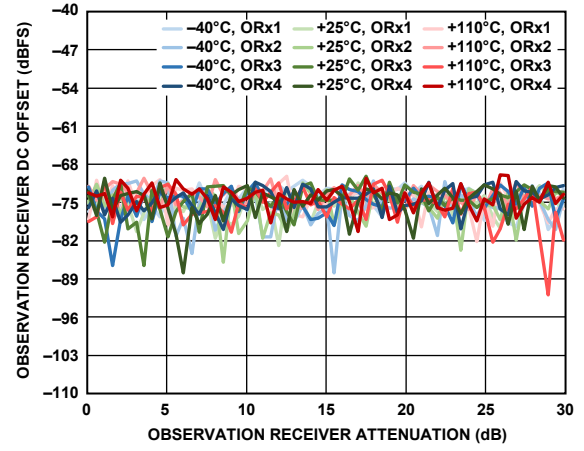

Figure 576. Observation Receiver DC Offset vs. Observation Receiver Attenuation, Sample Rate = 491.52 MSPS

22382-505

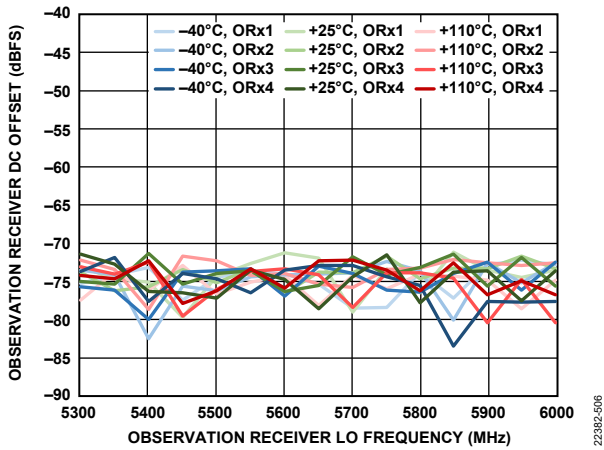

Figure 577. Observation Receiver DC Offset vs. Observation Receiver LO Frequency, Attenuation = 0 dB, Sample Rate = 491.52 MSPS

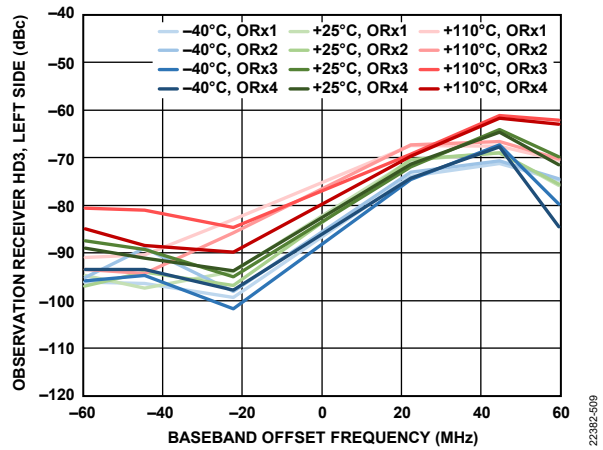

Figure 580. Observation Receiver HD3, Left Side vs. Baseband Offset Frequency, -10 dBFS Input Signal, Distortion Tone Measured Left of 0 Hz

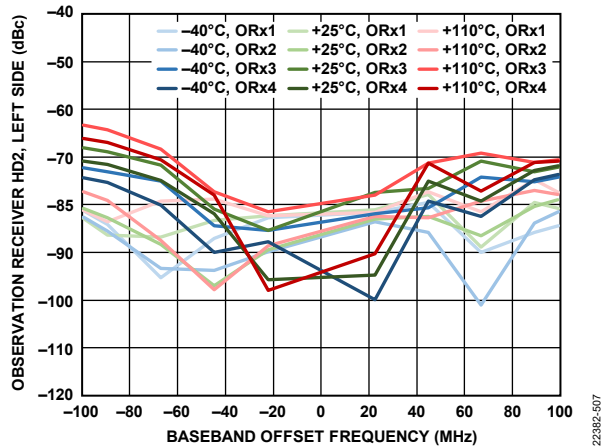

Figure 578. Observation Receiver HD2, Left Side vs. Baseband Offset Frequency, -10 dBFS Input Signal, Distortion Tone Measured Left of 0 Hz

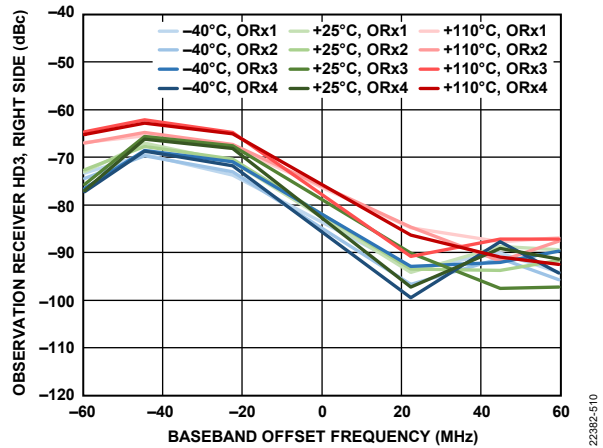

Figure 581. Observation Receiver HD3, Right Side vs. Baseband Offset Frequency, -10 dBFS Input Signal, Distortion Tone Measured Right of 0 Hz

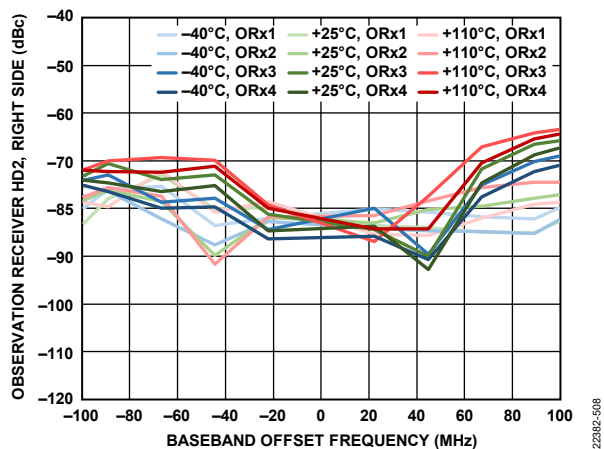

Figure 579. Observation Receiver HD2, Right Side vs. Baseband Offset Frequency, -10 dBFS Input Signal, Distortion Tone Measured Right of 0 Hz

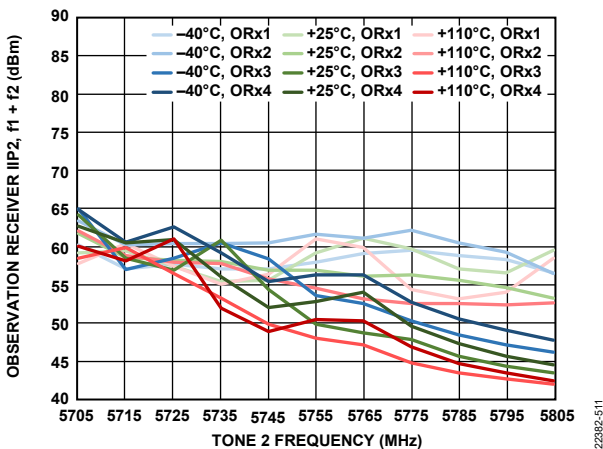

Figure 582. Observation Receiver IIP2,  $f_1 + f_2$  vs. Tone 2 Frequency, Both Tones at -13 dBFS,  $f_1 = f_2 + 2$  MHz

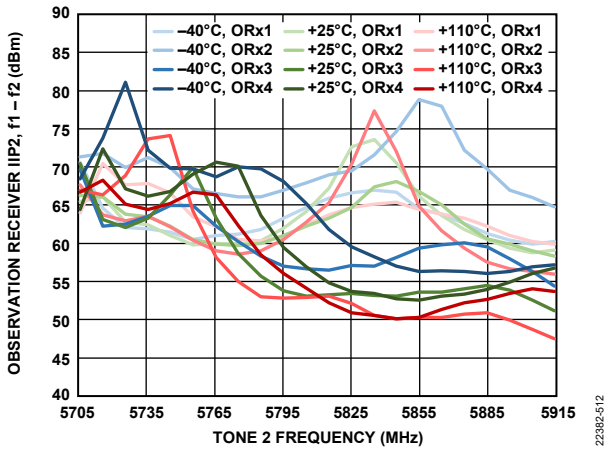

Figure 583. Observation Receiver IIP2,  $f_1 - f_2$  vs. Tone 2 Frequency, Both Tones at  $-13$  dBFS,  $f_1 = f_2 + 2$  MHz

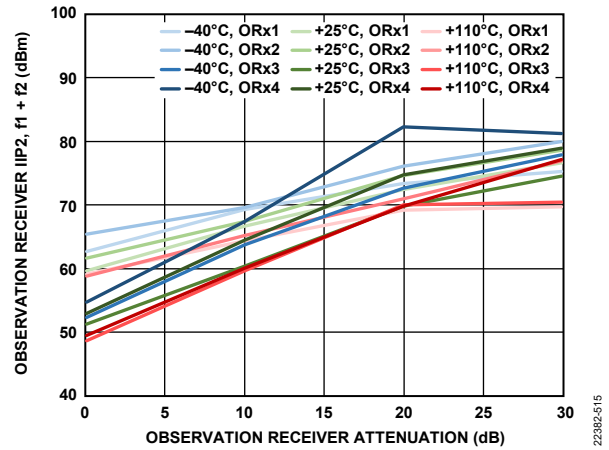

Figure 586. Observation Receiver IIP2,  $f_1 + f_2$  vs. Observation Receiver Attenuation, Both Tones at  $-13$  dBFS,  $f_1 = 102$  MHz,  $f_2 = 2$  MHz

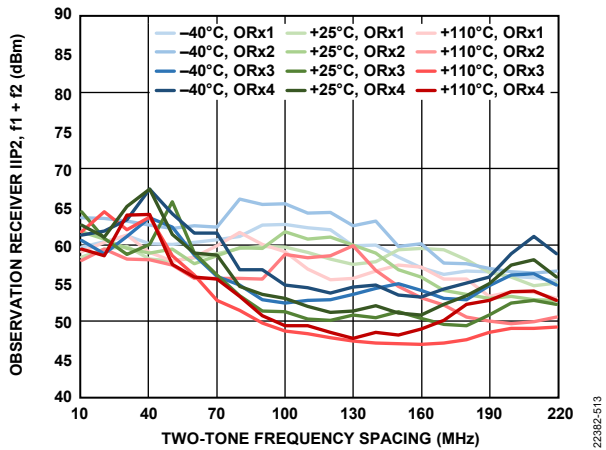

Figure 584. Observation Receiver IIP2,  $f_1 + f_2$  vs. Two-Tone Frequency Spacing, Both Tones at  $-13$  dBFS,  $f_2 = 2$  MHz

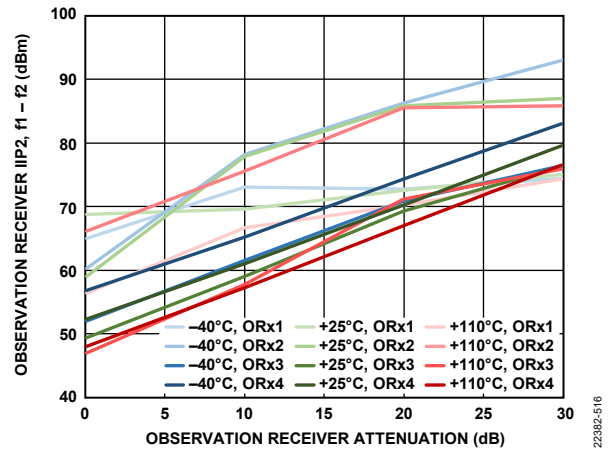

Figure 587. Observation Receiver IIP2,  $f_1 - f_2$  vs. Observation Receiver Attenuation, Both Tones at  $-13$  dBFS,  $f_1 = 102$  MHz,  $f_2 = 2$  MHz

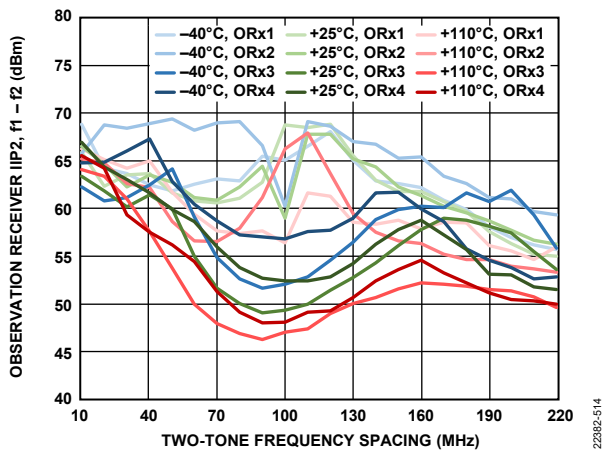

Figure 585. Observation Receiver IIP2,  $f_1 - f_2$  vs. Two-Tone Frequency Spacing, Both Tones at  $-13$  dBFS,  $f_2 = 2$  MHz

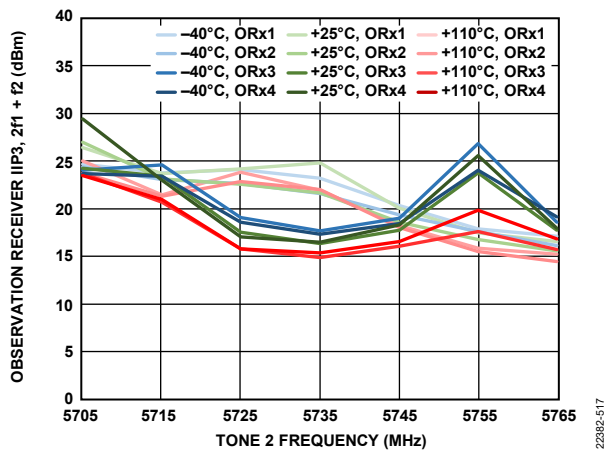

Figure 588. Observation Receiver IIP3,  $2f_1 + f_2$  vs. Tone 2 Frequency, Both Tones at  $-13$  dBFS,  $f_1 = f_2 + 2$  MHz

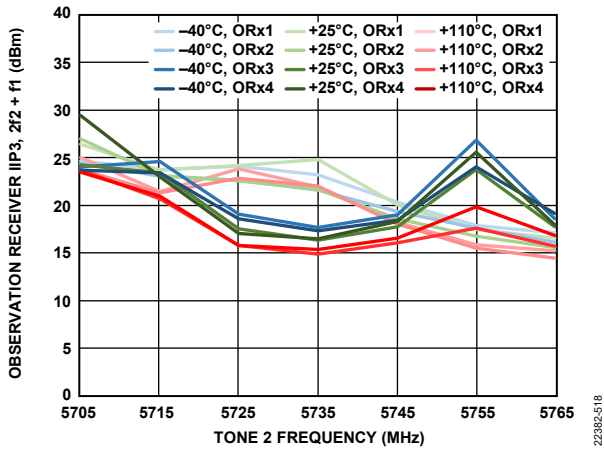

Figure 589. Observation Receiver IIP3, 2f2 + f1 vs. Tone 2 Frequency, Both Tones at -13 dBFS, f1 = f2 + 2 MHz

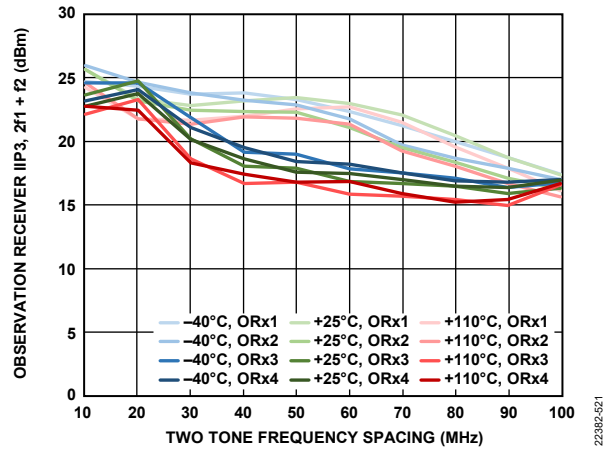

Figure 592. Observation Receiver IIP3, 2f1 + f2 vs. Two-Tone Frequency Spacing, Both Tones at -13 dBFS, f2 = 2 MHz

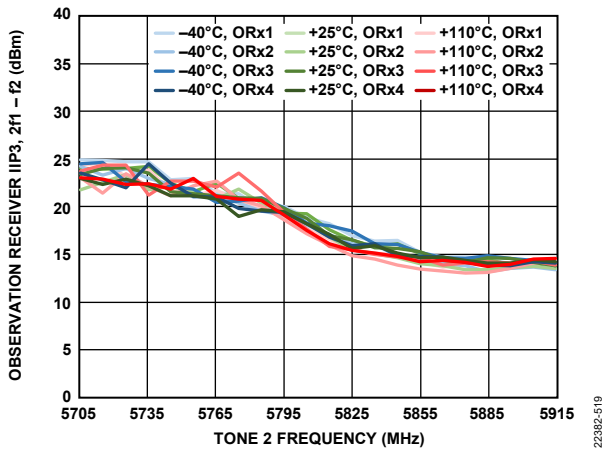

Figure 590. Observation Receiver IIP3, 2f1 - f2 vs. Tone 2 Frequency, Both Tones at -13 dBFS, f1 = f2 + 2 MHz

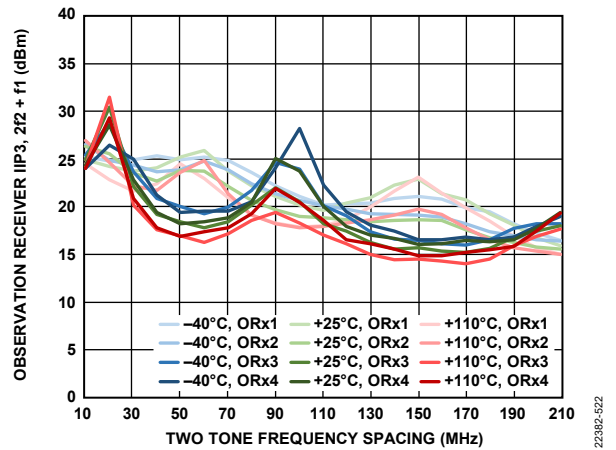

Figure 593. Observation Receiver IIP3, 2f2 + f1 vs. Two-Tone Frequency Spacing, Both Tones at -13 dBFS, f2 = 2 MHz

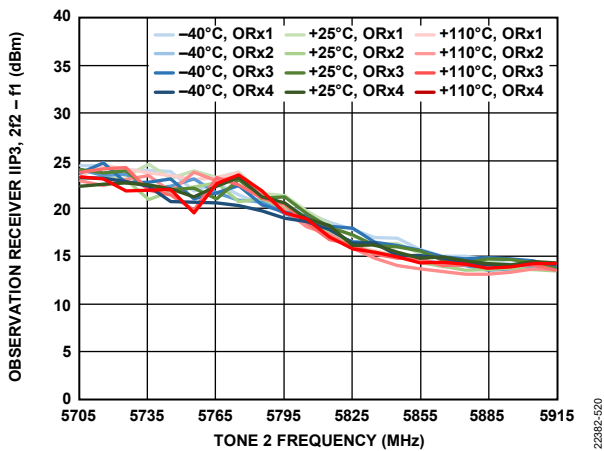

Figure 591. Observation Receiver IIP3, 2f2 - f1 vs. Tone 2 Frequency, Both Tones at -13 dBFS, f1 = f2 + 2 MHz

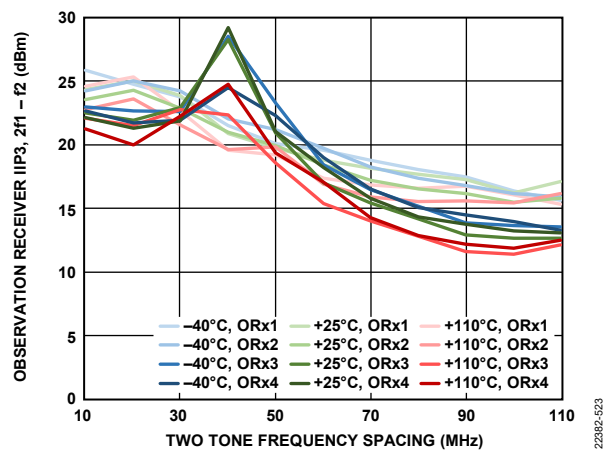

Figure 594. Observation Receiver IIP3, 2f1 - f2 vs. Two-Tone Frequency Spacing, Both Tones at -13 dBFS, f2 = 2 MHz

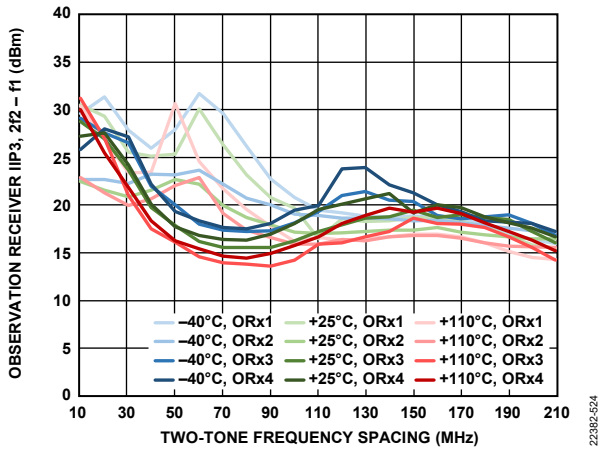

Figure 595. Observation Receiver IIP3,  $2f_2 - f_1$  vs. Two-Tone Frequency Spacing, Both Tones at  $-13$  dBFS,  $f_2 = 2$  MHz

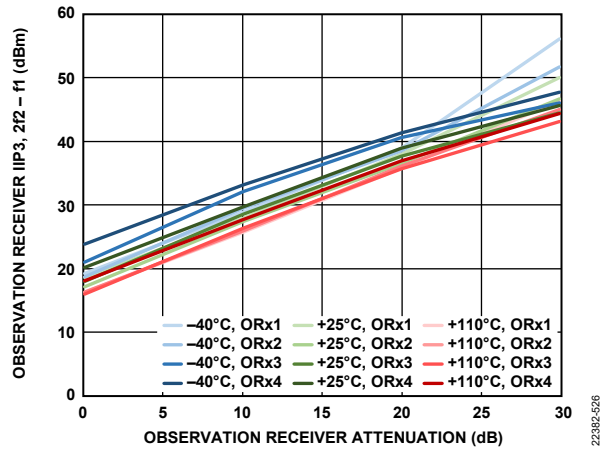

Figure 597. Observation Receiver IIP3,  $2f_2 - f_1$  vs. Observation Receiver Attenuation, Both Tones at  $-13$  dBFS,  $f_1 = 122$  MHz,  $f_2 = 2$  MHz

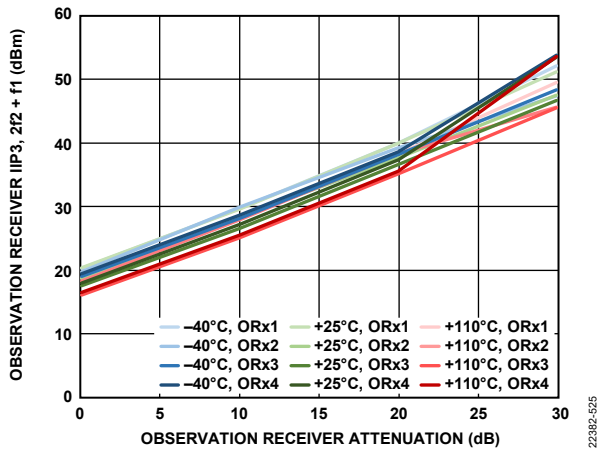

Figure 596. Observation Receiver IIP3,  $2f_2 + f_1$  vs. Observation Receiver Attenuation, Both Tones at  $-13$  dBFS,  $f_1 = 122$  MHz,  $f_2 = 2$  MHz

## THEORY OF OPERATION

### GENERAL

The ADRV9026 is a highly integrated RF transceiver capable of configuration for a wide range of applications. The device integrates all the RF, mixed-signal, and digital blocks necessary to provide all transmitter, traffic receiver, and observation receiver functions in a single device. Programmability allows the device to be adapted for use in many 3G/4G/5G cellular standards in frequency division duplex (FDD) and time division duplex (TDD) modes.

Four observation receiver channels monitor the transmitter outputs and provide tracking correction of dc offset, quadrature error, and transmitter LO leakage to maintain a high performance level under varying temperatures and input signal conditions. Firmware supplied with the device implements all initialization and calibration with no user interaction. Additionally, the device includes test modes allowing system designers to debug designs during prototyping and to optimize radio configurations.

The ADRV9026 contains four high speed serial interface (SERDES) links for the transmit chain and four high speed links shared by the receiver and observation receiver chains (JESD204B Subclass 1 compliant and supports JESD204C).

### TRANSMITTER

The ADRV9026 transmitter section consists of four identical and independently controlled channels that provide all the digital processing, mixed-signal, and RF blocks necessary to implement a direct conversion system while sharing a common frequency synthesizer. The digital data from the SERDES lanes pass through a digital processing block that includes a series of programmable half-band filters, interpolation stages, and FIR filters, including a programmable FIR filter with variable interpolation rates and up to 80 taps. The output of this digital chain is connected to the digital-to-analog converter (DAC). The DAC sample rate is adjustable up to 2.5 GHz. The in-phase (I) and quadrature (Q) channels are identical in each transmitter signal chain.

After conversion to baseband analog signals, the I and Q signals are filtered to remove sampling artifacts and fed to the upconversion mixers. Each transmit chain provides a wide attenuation adjustment range with fine granularity to help designers optimize signal-to-noise ratio (SNR).

### RECEIVER

The ADRV9026 provides four independent receiver channels. Each channel contains all the blocks necessary to receive RF signals and convert these signals to digital data usable by a baseband processor. Each receiver can be configured as a direct conversion system that supports up to a bandwidth of 200 MHz. Each channel contains a programmable attenuator stage, followed by matched I and Q mixers that downconvert received signals to baseband for digitization.

Two gain control options are available, as follows:

- Users can implement their own gain control algorithms using their baseband processor to manage manual gain control mode
- Users can use the on-chip automatic gain control (AGC) system.

Performance is optimized by mapping each gain control setting to specific attenuation levels at each adjustable gain block in the receive signal path. Additionally, each channel contains independent receive signal strength indication (RSSI) measurement capability, dc offset tracking, and all the circuitry necessary for self calibration.

The receivers include analog-to-digital converters (ADCs) and adjustable sample rates that produce data streams from the received signals. The signals can be conditioned further by a series of decimation filters and a programmable FIR filter with additional decimation settings. The sample rate of each digital filter block is adjustable by changing decimation factors to produce the desired output data rate. All receiver outputs are connected to the SERDES block, where the data is formatted and serialized for transmission to the baseband processor.

### OBSERVATION RECEIVER

The ADRV9026 provides four independent observation receiver inputs. These inputs are similar in implementation to the standard receiver channels in terms of the mixers, ADCs, and filtering blocks. The main difference is that these receivers operate with an observation bandwidth up to 450 MHz, allowing the receivers to receive all the transmitter channel information needed for implementing digital correction algorithms.

Each input is used as the feedback monitor channel for a corresponding transmitter channel. Table 14 shows the possible combinations of transmitter and observation channels.

**Table 14. Possible Transmitter-Observation Channel Combinations**

Transmitter Channel	Observation Channel
TX1±	ORX1± or ORX2±
TX2±	ORX1± or ORX2±
TX3±	ORX3± or ORX4±
TX4±	ORX3± or ORX4±

### CLOCK INPUT

The ADRV9026 requires a differential clock connected to the DEVCLK± pins. The frequency of the clock input must be between 15 MHz and 1000 MHz and must have low phase noise because this signal generates the RF LO and internal sampling clocks.

## SYNTHESIZERS

The ADRV9026 contains four fractional-N PLLs to generate the RF LO for the signal paths and all internal clock sources. This group of PLLs includes two RF PLLs for transmit and receive LO generation, an auxiliary PLL that can be used by the observation receivers, and a clock PLL. Each PLL is independently controlled with no need for external components to set frequencies.

### **RF Synthesizers**

The two RF synthesizers use fractional-N PLLs to generate RF LOs for multiple receiver and transmitter channels. The fractional-N PLL incorporates a four-core internal voltage controlled oscillator (VCO) and loop filter, capable of generating low phase noise signals with no external components required. An internal LO multiplexer (mux) enables each PLL to supply LOs to any or all receivers and transmitters (for example, LO1 to all transmitters, LO2 to all receivers), resulting in maximum flexibility when configuring the device for TDD operation. The LOs on multiple devices can be phase synchronized to support active antenna systems and beam forming applications.

### **Auxiliary Synthesizer**

The auxiliary synthesizer uses a single core VCO fractional-N PLL to generate the signals necessary to calibrate the device. The output of this block uses a separate mux system to route LOs for calibrating different functions during initialization. The auxiliary synthesizer can also be used to generate LO signals for the observation receivers or as an offset LO used in the receiver signal chains.

### **Clock Synthesizer**

The ADRV9026 contains a single core VCO fractional-N PLL synthesizer that generates all baseband related clock signals and SERDES clocks. This fractional-N PLL is programmed based on the data rate and sample rate requirements of the system, which typically require the system to operate in integer mode.

For JESD204B configurations with  $N_p = 12$  and JESD204C configurations, a dedicated PLL included in the SERDES block generates the SERDES clocks.

## SPI INTERFACE

The ADRV9026 uses a SPI to communicate with the baseband processor. This interface can be configured as a 4-wire interface with dedicated receive and transmit ports, or the interface can be configured as a 3-wire interface with a bidirectional data communications port. This bus allows the baseband processor to set all device control parameters using a simple address data serial bus protocol.

Write commands follow a 24-bit format. The first bit sets the bus direction of the bus transfer. The next 15 bits set the address where data is written. The final eight bits are the data being transferred to the specific register address.

Read commands follow a similar format with the exception that the first 16 bits are transferred on the SPI\_DIO pin, and the final eight bits are read from the ADRV9026, either on the SPI\_DO pin in 4-wire mode or on the SPI\_DIO pin in 3-wire mode.

## GPIO\_X PINS

The ADRV9026 provides 19 general-purpose input/output signals (GPIOs) referenced to VIF that can be configured for numerous functions. When configured as outputs, certain pins can provide real-time signal information to the baseband processor, allowing the baseband processor to determine receiver performance. A pointer register selects what information is output to these pins.

Signals used for manual gain mode, calibration flags, state machine status, and various receiver parameters are among the outputs that can be monitored on the GPIO pins. Additionally, certain GPIO pins can be configured as inputs and used for various functions, such as setting the receiver gain in real time.

## AUXILIARY CONVERTERS

### **GPIO\_ANA\_x/AUXDAC\_x**

The ADRV9026 contains eight analog GPIOs (the GPIO\_ANA\_x pins) that are multiplexed with eight identical auxiliary DACs (AUXDAC\_x). The analog GPIO ports can be used to control other analog devices or receive control inputs referenced to the VDDA\_1P8 supply. The auxiliary DACs are 12-bit converters capable of supplying up to 10 mA. These outputs are typically used to supply bias current or variable control voltages for other related components with analog control inputs.

### **AUXADC\_x**

The ADRV9026 contains two auxiliary ADCs with four total input pins (AUXADC\_x). These auxiliary ADCs provide 10-bit monotonic outputs with an input voltage range of 0.05 V to 0.95 V. When enabled, each auxiliary ADC is free running. An application programming interface (API) command latches the ADC output value to a register. The ADRV9026 also contains an ADC that supports a built-in diode-based temperature sensor.



## JTAG BOUNDARY SCAN

The ADRV9026 provides support for a JTAG boundary scan. There are five dual function pins associated with the JTAG interface. These pins, listed in Table 15, are used to access the on-chip test access port. To enable the JTAG functionality, set the GPIO\_0 pin through the GPIO\_2 pin according to Table 16, depending on how the desired JESD204B sync signals are configured in the software (differential or single-ended mode). Pull the TEST\_EN pin high to the VIF supply to enable the JTAG mode.

**Table 15. Dual Function Boundary Scan Test Pins**

Mnemonic	JTAG Mnemonic	Description
GPIO_14	TRST	Test access port reset
GPIO_15	TDO	Test data output
GPIO_16	TDI	Test data input
GPIO_17	TMS	Test access port mode select
GPIO_18	TCK	Test clock

**Table 16. JTAG Modes**

Test Pin Level	GPIO_2 to GPIO_0	Description
0	XXX <sup>1</sup>	Normal operation
1	000	JTAG mode with differential JESD204B sync signals
1	011	JTAG mode with single-ended JESD204B sync signals

<sup>1</sup> X means any combination.

## APPLICATIONS INFORMATION

### POWER SUPPLY SEQUENCE

The ADRV9026 requires a specific power-up sequence to avoid undesired power-up currents. In the optimal power-up sequence, the VDIG\_1P0 supply is activated first. When VDIG\_1P0 powers VDDA\_1P0, then all 1.0 V supplies can be powered on at the same time.

If VDIG\_1P0 is isolated, all VDDA\_1P8, VDDA\_1P3, and VDDA\_1P0 supplies must be powered up after VDIG\_1P0 is activated. The VIF supply can be powered up at any time.

It is also recommended prior to configuration to toggle the RESET signal after power has stabilized.

If a power-down sequence is followed, to avoid any back biasing of the digital control lines, remove the VDIG\_1P0 supply last. If no sequencing is used, it is recommended to power down all supplies simultaneously.

### DATA INTERFACE

The digital data interface for the ADRV9026 implements JEDEC Standard JESD204B Subclass 1 and JESD204C. The serial interface operates at speeds of up to 24,330.24 Mbps. Table 17, Table 18, and Table 19 list example parameters for various JESD interface settings. Other output rates, bandwidth, and number of lanes are also supported for each of the interface rates reported in Table 17, Table 18, and Table 19.

Table 17. Example Receiver Interface Rates with Four Channels Active (M = 8)

Bandwidth (MHz)	Output Rate (MSPS)	JESD Np Parameter	JESD204B F Parameter	JESD204B Lane Rate (Mbps)	JESD204B Number of Lanes	JESD204C F Parameter	JESD204C Lane Rate (Mbps)	JESD204C Number of Lanes
40	61.44	16	16	9830.4	1	16	8110.08	1
60	76.8	16	16	12288	1	16	10137.6	1
100	122.88	16	8	9830.4	2	8	8110.08	2
150	184.32	16	4	7372.8	4	8	12165.12	2
200	245.76	16	4	9830.4	4	4	8110.08	4
200	245.76	12	3	7372.8	4	6	12165.12	2
200	245.76	12	6	14745.6	2	12	24330.24	1

Table 18. Transmitter Interface Rates with Four Channels Active (M = 8)

Primary Signal Bandwidth (MHz)	Total Bandwidth (MHz)	Input Rate (MSPS)	JESD Np Parameter	JESD204B F Parameter	JESD204B Lane Rate (Mbps)	JESD204B Number of Lanes	JESD204C F Parameter	JESD204C Lane Rate (Mbps)	JESD204C Number of Lanes
50	113	122.88	16	8	9830.4	2	8	8110.08	2
75	150	184.32	16	4	7372.8	4	8	12165.12	2
100	225	245.76	16	4	9830.4	4	4	8110.08	4
100	225	245.76	12	3	7372.8	4	6	12165.12	2
200	450	491.52	12	3	14745.6	4	8	24330.24	2

Table 19. Observation Path Interface Rates with 1 Channel Active (M = 2)

Total Bandwidth (MHz)	Output Rate (MSPS)	JESD Np Parameter	JESD204B F Parameter	JESD204B Lane Rate (Mbps)	JESD204B Number of Lanes	JESD204C F Parameter	JESD204C Lane Rate (Mbps)	JESD204C Number of Lanes
150	184.32	16	4	7372.8	1	4	6082.56	1
225	245.76	16	4	9830.4	1	4	8110.08	1
225	245.76	12	3	7372.8	1	3	6082.56	1
250	307.2	16	4	12288	1	4	10137.6	1
300	368.64	16	2	7372.8	2	4	12165.12	1
450	491.52	16	2	9830.4	2	2	8110.08	2
450	491.52	12	3	14745.6	1	4	12165.12	1

# OUTLINE DIMENSIONS

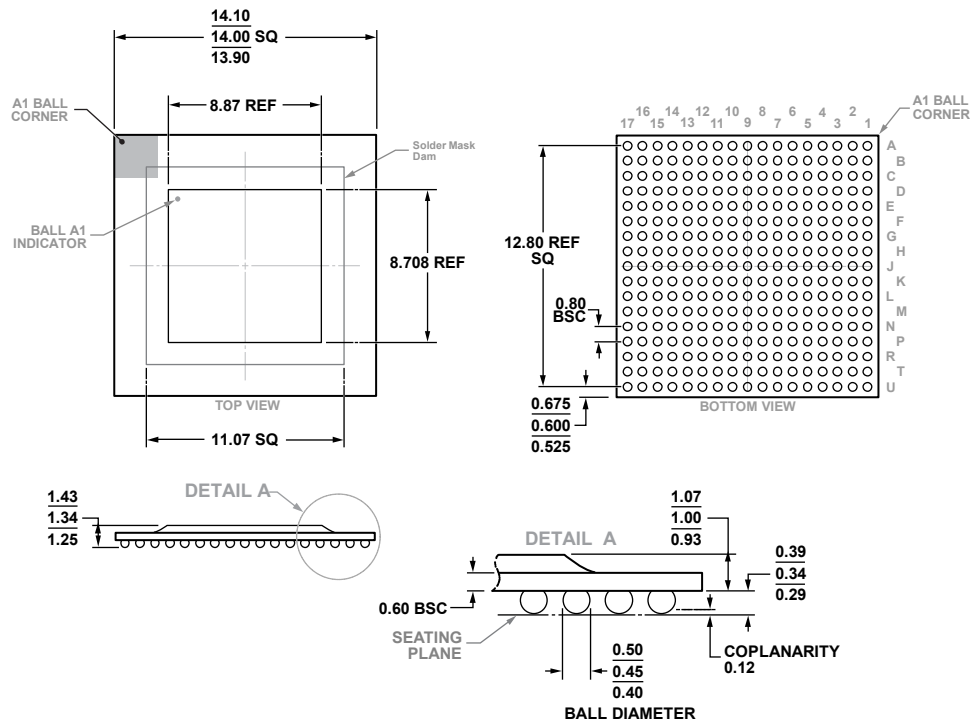

COMPLIANT TO JEDEC STANDARDS MO-275-JJAB-1

Figure 598. 289-Ball Chip Scale Package Ball Grid Array [CSP\_BGA] (BC-289-6)

Dimensions shown in millimeters

04-26-2019-A

## ORDERING GUIDE

Model <sup>1, 2</sup>	Temperature Range <sup>3</sup>	Package Description	Package Option
ADRV9026BBCZ	-40°C to +110°C	289-Ball Chip Scale Package Ball Grid Array [CSP_BGA]	BC-289-6
ADRV9026BBCZ-REEL	-40°C to +110°C	289-Ball Chip Scale Package Ball Grid Array [CSP_BGA]	BC-289-6
ADRV9026-HB/PCBZ		High Band Evaluation Board for 2.8 GHz to 6 GHz	
ADRV9026-MB/PCBZ		Mid Band Evaluation Board for 650 MHz to 2.8 GHz	
ADRV9026-LB/PCBZ		Low Band Evaluation Board for 50 MHz to 1.0 GHz	
ADS9-V2EBZ		ADS9-V2 Motherboard	

<sup>1</sup> Z = RoHS Compliant Part.

<sup>2</sup> The ADS9-V2EBZ motherboard (ordered separately) must be used with the ADRV9026-HB/PCBZ or ADRV9026-MB/PCBZ evaluation board.

<sup>3</sup> See the Junction Temperature section.