

22.5 mm Timer H3DEZ

DIN Track Mounted, Standard 22.5-mm Width Timer Range

- A wide AC/DC power supply range (24 to 240 VAC/DC) reduces the number of timer models kept in stock.
- Terminal clamp left open when delivered.
- Finger protection terminal block.

Broad Line-up of H3DEZ Series

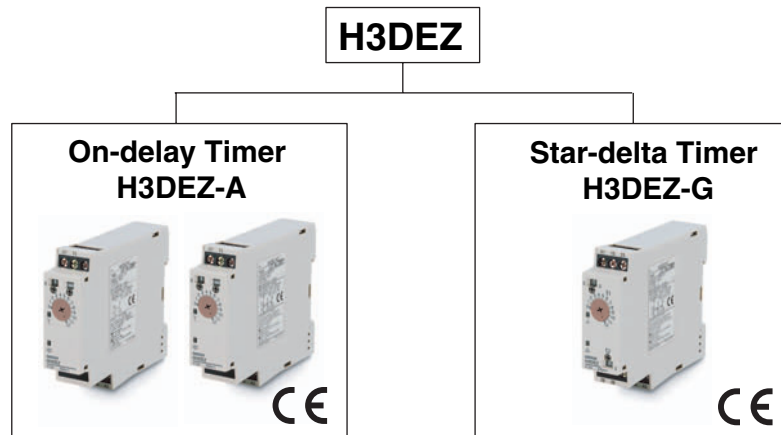

22.5 mm On-delay Timer H3DEZ-A

- A wide time setting range of 0.10 s to 120 h.
- Single mode (On-delay) Timer.



Model Number Structure

Model Number Legend

H3DEZ - A

--

1 2

1. A: ON-delay
2. 1: SPDT
- 2: DPDT

Ordering Information

List of Models

Supply voltage	Control output	Model
24 to 240 VAC/DC	Contact output: SPDT (time-limit output SPDT)	H3DEZ-A1
	Contact output: DPDT (time-limit output)	H3DEZ-A2

Accessories (Order Separately)

Optional Products for Track Mounting		Model
Mounting Track	50 cm (l) x 7.3 mm (t)	PFP-50N
	1 m (l) x 7.3 mm (t)	PFP-100N
	1 m (l) x 16 mm (t)	PFP-100N2
End Plate		PFP-M
Spacer		PFP-S

Specifications

General

Item	H3DEZ-A1	H3DEZ-A2
Operating mode	ON-delay	
Terminal block	Clamps two 2.5 mm ² max. bar terminals without sleeves.	
Output type	Relay: SPDT	Relay: DPDT
Mounting method	DIN track mounting (see note)	
Approved standards	Conforms to EN61812-1, IEC60664-1 4 kV/2 Output category according to IEC60947-5-1 (AC-13; 250 V 5A/AC-15; 250 V 3 A/DC-13; 30 V 0.1 A)	

Note: Can be mounted to 35-mm DIN track with a plate thickness of 1 to 2.5 mm.

Time Ranges

Time scale display	Time unit display			
	sec	min	hrs	10 h
x 0.1	0.1 to 1.2 s	0.1 to 1.2 min	0.1 to 1.2 h	1 to 12 h
x 1	1 to 12 s	1 to 12 min	1 to 12 h	10 to 120 h

Ratings

Rated supply voltage (see notes 1 and 2)		24 to 240 VAC/DC (50/60 Hz)
Operating voltage range		80% to 110% of rated supply voltage
Power reset		Minimum power-off time: 0.1 s
Reset voltage		2.4 VAC/DC max. (see note 4)
Power consumption (see note 3)	H3DEZ-A1	AC: approx. 2.9 VA (1.6 W) at 240 VAC DC: approx. 0.7 W at 24 VDC (see note 4)
	H3DEZ-A2	AC: approx. 3.4 VA (1.9 W) at 240 VAC DC: approx. 1.0 W at 24 VDC (see note 4)
Control output		Contact output: 5 A at 250 VAC with resistive load ($\cos\phi = 1$) 5 A at 30 VDC with resistive load ($\cos\phi = 1$) (see note 5)
Ambient temperature		Operating: -10°C to 55°C (with no icing) Storage: -25°C to 70°C (with no icing)
Ambient humidity		Operating: 35% to 85%

- Note:**
- DC ripple rate: 20% max.
 - Since an inrush current of 0.25 A will occur when using the power supply voltage at 24 VDC, pay careful attention when turning on or off the power supply to the Timer with a solid-state output such as a sensor.
 - The power consumption is for mode A after the Timer counts the time-up time and for the AC input at 50 Hz.
 - Actual value.
 - For reference: A maximum current of 0.15 A can be switched at 125 VDC ($\cos\phi=1$).
A maximum current of 0.1 A can be switched if L/R is 7 ms.
In both cases, a life of 100,000 operations can be expected.
The minimum applicable load is 10 mA at 5 VDC (failure level: P).

Characteristics

Accuracy of operating time	±1% max. of FS	
Setting error	±5% of FS (see note)	
Influence of voltage	±2% max. of FS (see note)	
Influence of temperature	±5% max. of FS (see note)	
Dielectric strength	Between current-carrying metal parts and exposed non-current-carrying metal parts: 2,000 VAC for 1 min. Between control output terminals and operating circuit: 2,000 VAC for 1 min. Between contacts of different polarities: 2,000 VAC for 1 min. Between contacts not located next to each other: 1,000 VAC for 1 min.	
Life expectancy	Mechanical: 10 million operations min. (under no load at 1,800 operations/h) Electrical: 100,000 operations min. (5 A at 250 VAC, resistive load at 360 operations/h)	
EMC	(EMI) Emission Enclosure: Emission AC Mains: (EMS) Immunity ESD: Immunity RF-interference from AM Radio Waves: Immunity Burst: Immunity Surge:	EN61812-1 EN55011 Group 1 class B EN55011 Group 1 class B EN61812-1 EN61000-4-2: 6 kV contact discharge (level 3) 8 kV air discharge (level 3) EN61000-4-3: 10 V/m (80 MHz to 1 GHz) (level 3) EN61000-4-4: 2 kV power port and output port (level 3) 1 kV control port with capacitive clamp (level 3) EN61000-4-5: 2 kV common mode (level 3) 1 kV differential mode (level 3)
Degree of protection	IP20	
Weight	120 g	

Note: Actual value.

H3DEZ-A

Connections

Block Diagram

H3DEZ-A1/A2

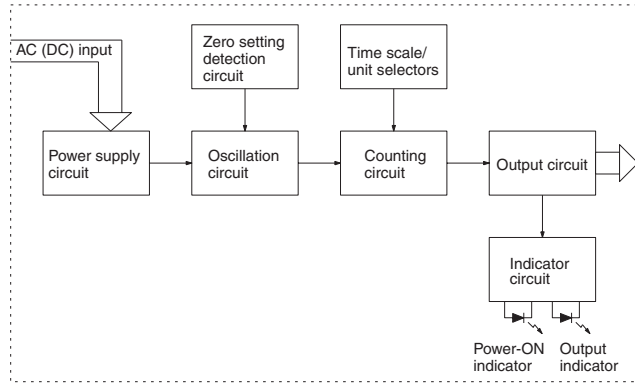

Terminal Arrangement

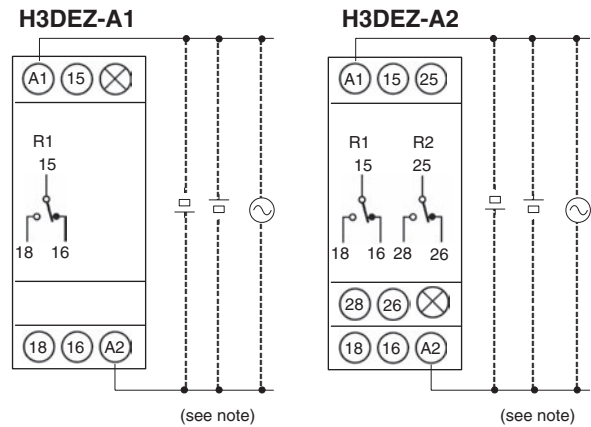

(DIN notation)

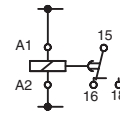

(DIN notation)

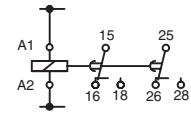

Note: DC supply voltage does not require the designation of polarity.

I/O Functions

Item	H3DEZ-A1/A2
Output	Control output
	Outputs are turned ON according to designated output mode when preset value is reached.

Operation

Basic Operation

Setting of Selector

The selectors can be turned clockwise and counterclockwise to select the desired time unit, time scale, or operating mode. Each selector has a snap mechanism that secures the selector at a given position. Set the selector at a position at which it is secured. Do not set it midway between two securing positions or a malfunction could result from improper setting.

Selection of Time Unit and Time Scale

The desired time unit (s, m, h, or 10h) can be displayed in the time unit display window above the time setting dial by turning the time unit selector located at the upper right corner of the front panel. Time scale (0.1 or 1) is selected with the time scale selector at the upper left corner of the front panel, it appears in the time scale display window

above the selector.

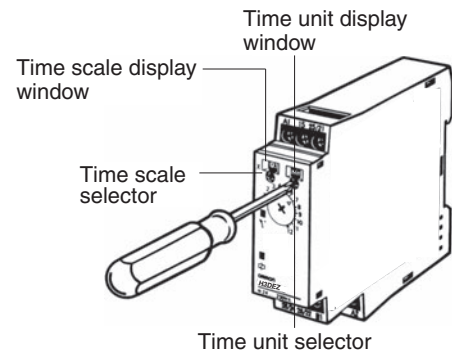

Timing Chart

- Note:** 1. The minimum power reset time is 0.1 s.
2. The letter "t" in the timing charts stands for the set time and "t-a" means that the period is less than the time set.

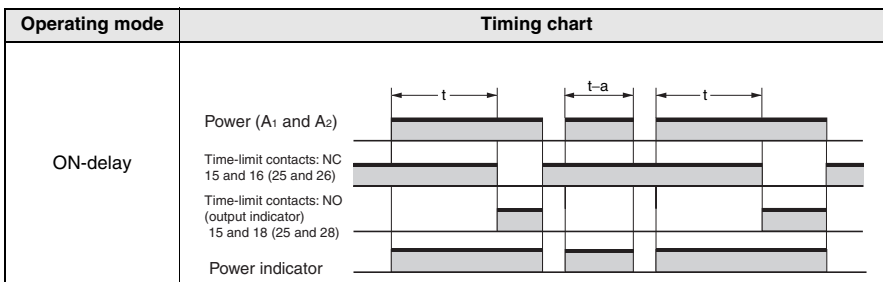

Nomenclature

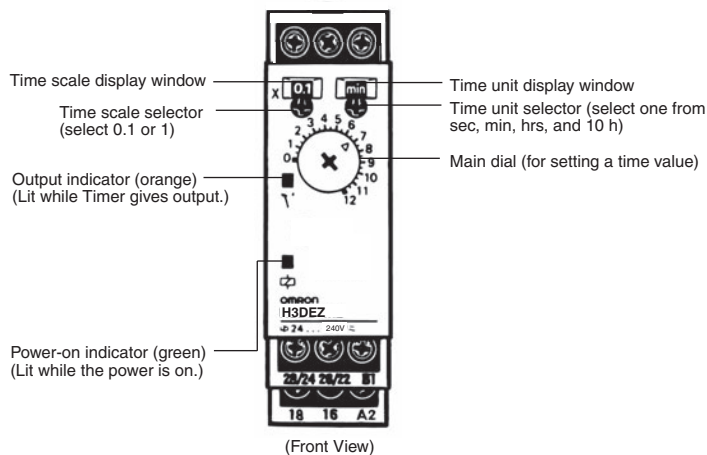

Dimensions

Note: All units are in millimeters unless otherwise indicated.

H3DEZ-A

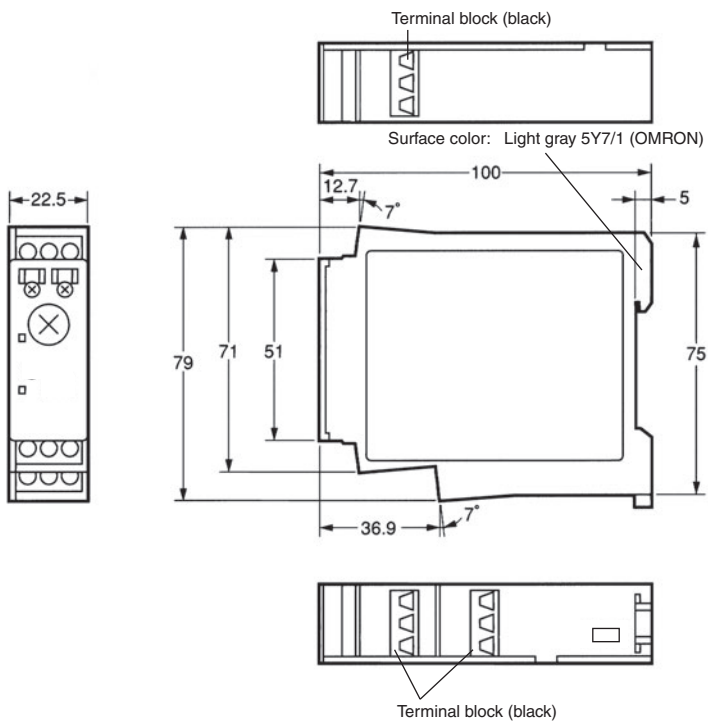
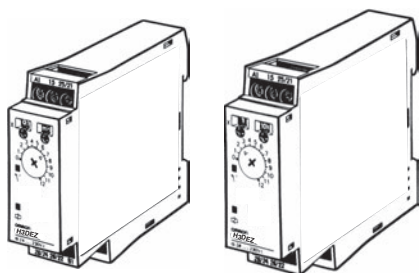

ALL DIMENSIONS SHOWN ARE IN MILLIMETERS.
To convert millimeters into inches, multiply by 0.03937. To convert grams into ounces, multiply by 0.03527.

In the interest of product improvement, specifications are subject to change without notice.

22.5 mm Star-delta Timer H3DEZ-G

- A wide star-time range (up to 120 seconds) and star-delta transfer time range (up to 0.5 seconds)



Model Number Structure

Model Number Legend

H3DEZ - G
1

1. G: Star-delta timer

Ordering Information

List of Models

Supply voltage	Model
24 to 240 VAC/VDC	H3DEZ-G

Accessories (Order Separately)

Optional Products for Track Mounting		Model
Mounting Track	50 cm (l) x 7.3 mm (t)	PFP-50N
	1 m (l) x 7.3 mm (t)	PFP-100N
	1 m (l) x 16 mm (t)	PFP-100N2
End Plate		PFP-M
Spacer		PFP-S

Specifications

General

Item	H3DEZ-G
Operating mode	Star-delta operation
Operating/Reset method	Time-limit operation/Self-reset
Terminal block	Clamps two 2.5 mm ² max. bar terminals without sleeves
Output type	(Star operation circuit) Relay: SPDT (Delta operation circuit) Relay: SPDT
Mounting method	DIN track mounting (see note)
Approved standards	Conforms to EN61812-1, IEC60664-1 4 kV/2 Output category according to IEC60947-5-1 (AC-13; 250 V 5A/AC-15; 250 V 3 A/DC-13; 30 V 0.1 A)

Note: Can be mounted to 35-mm DIN track with a plate thickness of 1 to 2.5 mm.

Time Ranges

Time scale display	Star operation time ranges
x 1	1 to 12 s
x 10	10 to 120 s

Star-delta transfer time	Programmable at 0.05 s, 0.1 s, 0.25 s or 0.5 s
---------------------------------	--

Ratings

Rated supply voltage (see note 1)	24 to 240 VAC/VDC (50/60 Hz)
Operating voltage range	80% to 110% of rated supply voltage
Power reset	Minimum power-off time: 0.5 s
Reset voltage	2.4 VAC/DC max. (see note 2)
Power consumption	AC: Approx. 3.2 VA (1.8 W) at 240 VAC DC: Approx. 0.8 W at 24 VDC (see note 2)
Control output	Contact output: 5 A at 250 VAC with resistive load ($\cos\phi = 1$) 5 A at 30 VDC with resistive load ($\cos\phi = 1$) (see note 3)
Ambient temperature	Operating: -10°C to 55°C (with no icing) Storage: -25°C to 70°C (with no icing)
Ambient humidity	Operating: 35% to 85%

- Note:** 1. DC ripple rate: 20% max.
2. Actual value.
3. For reference:
A maximum current of 0.15 A can be switched at 125 VDC ($\cos\phi=1$).
A maximum current of 0.1 A can be switched if L/R is 7 ms.
In both cases, a life of 100,000 operations can be expected.
The minimum applicable load is 10 mA at 5 VDC (failure level: P).

Characteristics

Accuracy of operating time	±1% max. of FS
Setting error	±5% max. of FS (see note)
Total tolerance of transfer time	± (25% FS + 5 ms) max. (see note)
Influence of voltage	±2% max. of FS (see note)
Influence of temperature	±5% max. of FS (see note)
Dielectric strength	Between current-carrying metal parts and exposed non-current-carrying metal parts: 2,000 VAC (50/60 Hz) for 1 min. Between control output terminals and operating circuit: 2,000 VAC (50/60 Hz) for 1 min. Between contacts not located next to each other: 1,000 VAC (50/60 Hz) for 1 min.
Life expectancy	Mechanical: 10 million operations min. (under no load at 1,800 operations/h) Electrical: 100,000 operations min. (5 A at 250 VAC, resistive load at 360 operations/h)
EMC	(EMI) EN61812-1 Emission Enclosure: EN55011 Group 1 class B Emission AC Mains: EN55011 Group 1 class B (EMS) EN61812-1 Immunity ESD: EN61000-4-2: 6 kV contact discharge (level 3) 8 kV air discharge (level 3) Immunity RF-interference from AM Radio Waves: EN61000-4-3: 10 V/m (80 MHz to 1 GHz) (level 3) Immunity Burst: EN61000-4-4: 2 kV power port and output port (level 3) 1 kV control port with capacitive clamp (level 3) Immunity Surge: EN61000-4-5: 2 kV common mode (level 3) 1 kV differential mode (level 3)
Degree of protection	IP20
Weight	Approx. 120 g

Note: Actual value.

Block Diagram

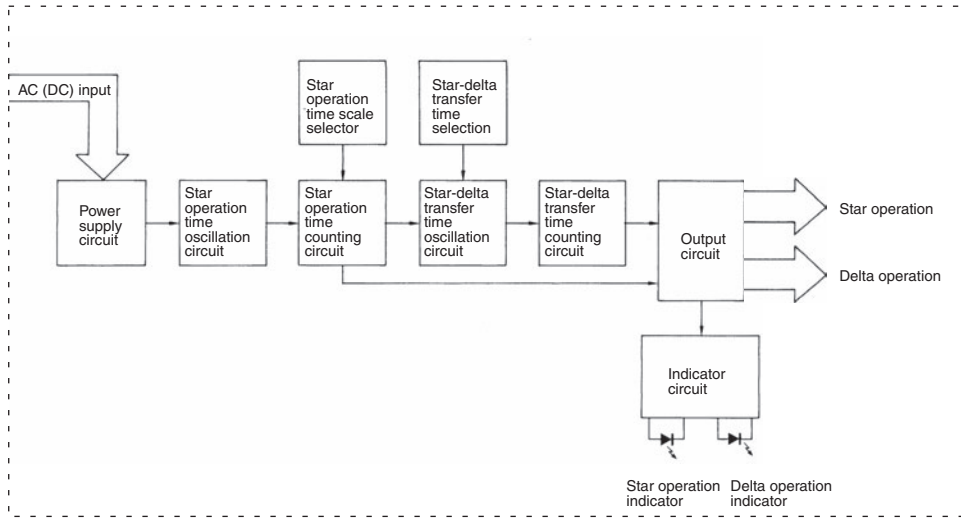

I/O Functions

Inputs	---	
Outputs	Control output	Star output is turned OFF when the dial set value is reached and delta output is ON after the preset transfer time elapses

Terminal Arrangement

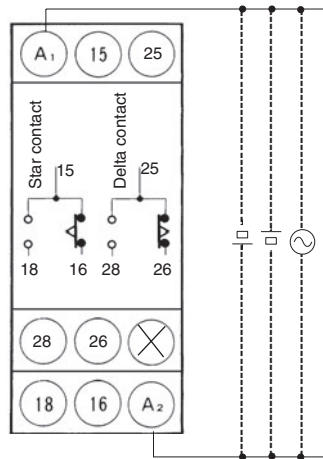

(DIN notation)

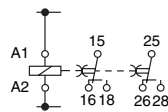

Note: DC supply voltage does not require the designation of polarity.

Operation

Basic Operation

Time Unit Setting

The star-delta transfer time is set to 0.05, 0.1, 0.25 or 0.5 with the star-delta transfer time selector on the lower-right side of the front panel and the set value appears in the star-delta transfer time display window below the selector.

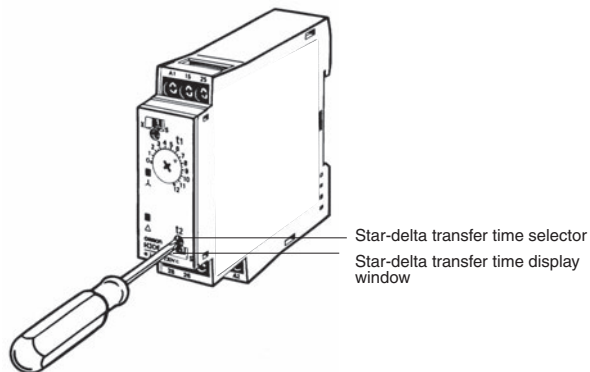

Timing Charts

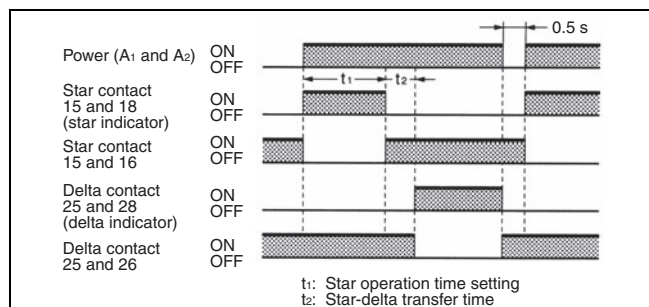

Note: The reset time requires a maximum of 0.5 s.

Nomenclature

Time Scale Selection

The star operation time scale selector on the upper-left side of the front panel can be set to 1 or 10 as a magnification.

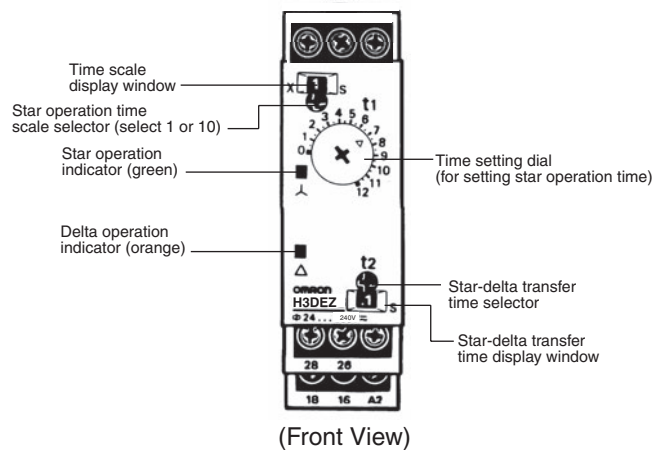
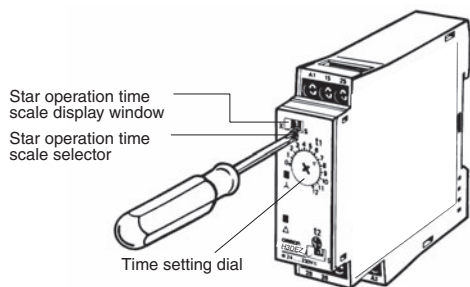

Time Setting

The operation time of the Timer is set with the time setting dial.

Dimensions

H3DEZ-G

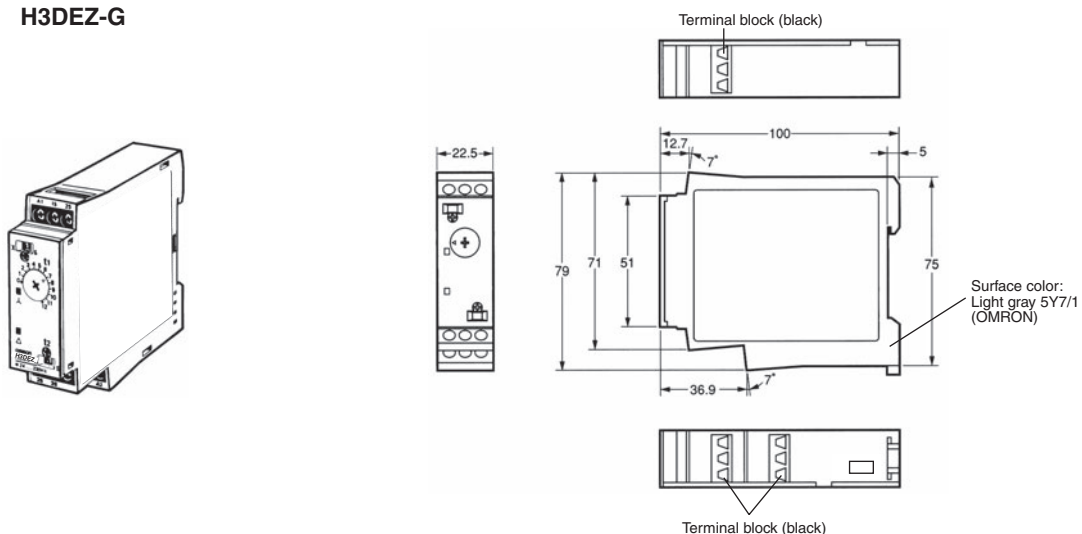

ALL DIMENSIONS SHOWN ARE IN MILLIMETERS.
To convert millimeters into inches, multiply by 0.03937. To convert grams into ounces, multiply by 0.03527.

In the interest of product improvement, specifications are subject to change without notice.

H3DEZ

Accessories (Order Separately) (Common)

Note: The following is common for all H3DEZ models.

Note: All units are in millimeters unless otherwise indicated.

Dimensions

Mounting Track

PFP-100N, PFP-50N

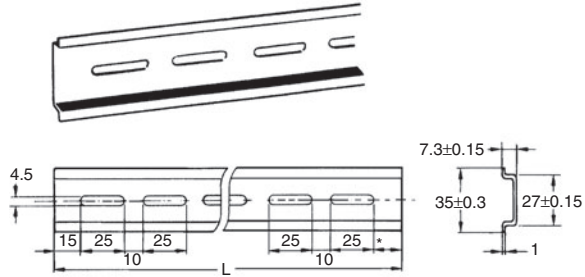

PFP-100N2

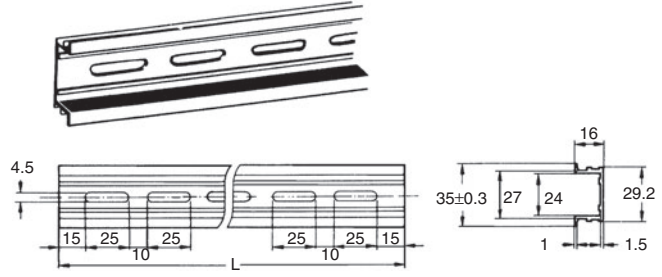

L: Length

1 m	PFP-100N
50 cm	PFP-50N
1 m	PFP-100N2

End Plate

PFP-M

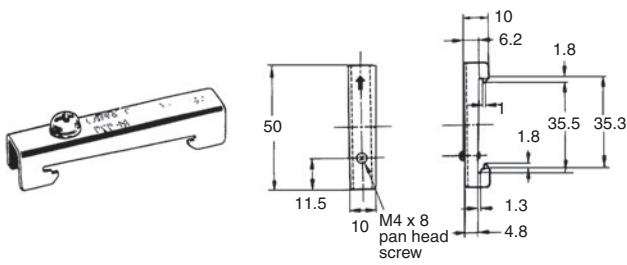

Spacer

PFP-S

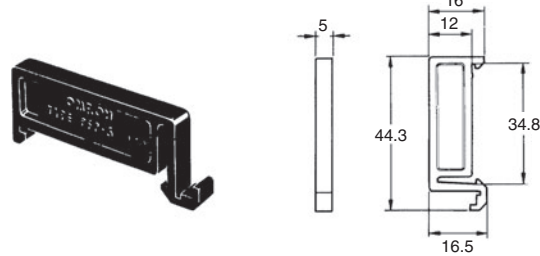

Safety Precautions (Common)

Refer to *Safety Precautions for All Timers*.

Note: The following is common for all H3DEZ models.

Changing of Setting

CAUTION

Do not change the time unit, time scale, operating mode, or output type selector switch while the Timer is in operation or malfunction could result.

Mounting and Dismounting

The H3DEZ should be mounted as horizontally as possible. When mounting the H3DEZ on a socket mounting track, hook portion (A) of the Timer to an edge of the track first, and then depress the Timer in the direction of (B).

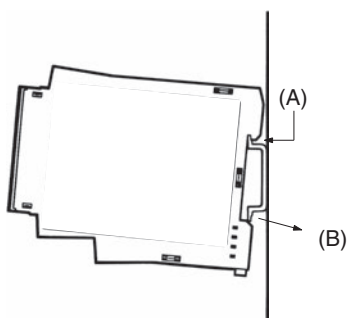

When dismantling the H3DEZ, pull out portion (C) with a flat-blade screwdriver and remove the Timer from the mounting track.

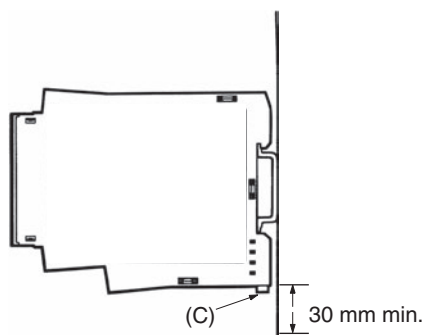

The H3DEZ can be mounted and dismantled with ease if a distance of 30 mm or more is kept between the H3DEZ and the top surface of other equipment located below the H3DEZ.

Power Supplies

The H3DEZ Series is provided with a transformerless power supply system. An electric shock may be received if the output type selector switch is touched while power is being supplied.

Use the bar terminal for wiring the H3DEZ. Using a stranded-wire terminal may cause a short-circuit due to a stray wire entering into the Timer.

Both AC and DC power supplies can be connected to the power input terminals without regarding polarity.

With the H3DEZ only, a DC power supply must be connected to the power input terminals as designated according to the polarity of the terminals.

A DC power supply can be connected if its ripple factor is 20% or less and the mean voltage is within the rated operating voltage range of the Timer.

Connect the power supply voltage through a relay or switch in such a way that the voltage reaches a fixed value at once or the Timer may not be reset or a timer error could result.

Precautions for EN61812-1 Conformance

The H3DEZ as a built-in timer conforms to EN61812-1 provided that the following conditions are satisfied:

The output section of the H3DEZ is provided only with basic isolation. To ensure reinforced isolation required by the EN61812-1, provide supplementary basic isolation on the load side connected to the output.

The H3DEZ itself is designed according to the following:

- Overvoltage category III
- Pollution degree 2

On the above basis:

Operation parts on the front and bottom: Reinforced isolation

- With clearance of 5.5 mm and creepage distance of 5.5 mm at 230 VAC

Output: Basic isolation

- With clearance of 3 mm and creepage distance of 3 mm at 230 VAC

Environment

When using the Timer in an area with excess electronic noise, separate the Timer, wiring, and the equipment which generates the input signals as far as possible from the noise sources. It is also recommended to shield the input signal wiring to prevent electronic interference.

Organic solvents (such as paint thinner), as well as very acidic or basic solutions can damage the outer casing of the Timer. Do not use the Timer in places where it is exposed to dust, corrosive gas, or direct sunlight.

When storing the Timer, make sure that the ambient temperature and humidity are within the rated values. Leave the Timer at room temperature for at least three hours before using the Timer if it has been stored at an ambient temperature of -10°C or below.

Warranty and Application Considerations

Read and Understand This Catalog

Please read and understand this catalog before purchasing the products. Please consult your OMRON representative if you have any questions or comments.

Warranty and Limitations of Liability

WARRANTY

OMRON's exclusive warranty is that the products are free from defects in materials and workmanship for a period of one year (or other period if specified) from date of sale by OMRON.

OMRON MAKES NO WARRANTY OR REPRESENTATION, EXPRESS OR IMPLIED, REGARDING NON-INFRINGEMENT, MERCHANTABILITY, OR FITNESS FOR PARTICULAR PURPOSE OF THE PRODUCTS. ANY BUYER OR USER ACKNOWLEDGES THAT THE BUYER OR USER ALONE HAS DETERMINED THAT THE PRODUCTS WILL SUITABLY MEET THE REQUIREMENTS OF THEIR INTENDED USE. OMRON DISCLAIMS ALL OTHER WARRANTIES, EXPRESS OR IMPLIED.

LIMITATIONS OF LIABILITY

OMRON SHALL NOT BE RESPONSIBLE FOR SPECIAL, INDIRECT, OR CONSEQUENTIAL DAMAGES, LOSS OF PROFITS, OR COMMERCIAL LOSS IN ANY WAY CONNECTED WITH THE PRODUCTS, WHETHER SUCH CLAIM IS BASED ON CONTRACT, WARRANTY, NEGLIGENCE, OR STRICT LIABILITY.

In no event shall the responsibility of OMRON for any act exceed the individual price of the product on which liability is asserted.

IN NO EVENT SHALL OMRON BE RESPONSIBLE FOR WARRANTY, REPAIR, OR OTHER CLAIMS REGARDING THE PRODUCTS UNLESS OMRON'S ANALYSIS CONFIRMS THAT THE PRODUCTS WERE PROPERLY HANDLED, STORED, INSTALLED, AND MAINTAINED AND NOT SUBJECT TO CONTAMINATION, ABUSE, MISUSE, OR INAPPROPRIATE MODIFICATION OR REPAIR.

Application Considerations

SUITABILITY FOR USE

OMRON shall not be responsible for conformity with any standards, codes, or regulations that apply to the combination of products in the customer's application or use of the products.

Take all necessary steps to determine the suitability of the product for the systems, machines, and equipment with which it will be used.

Know and observe all prohibitions of use applicable to this product.

NEVER USE THE PRODUCTS FOR AN APPLICATION INVOLVING SERIOUS RISK TO LIFE OR PROPERTY WITHOUT ENSURING THAT THE SYSTEM AS A WHOLE HAS BEEN DESIGNED TO ADDRESS THE RISKS, AND THAT THE OMRON PRODUCTS ARE PROPERLY RATED AND INSTALLED FOR THE INTENDED USE WITHIN THE OVERALL EQUIPMENT OR SYSTEM.

Disclaimers

PERFORMANCE DATA

Performance data given in this catalog is provided as a guide for the user in determining suitability and does not constitute a warranty. It may represent the result of OMRON's test conditions, and the users must correlate it to actual application requirements. Actual performance is subject to the OMRON *Warranty and Limitations of Liability*.

CHANGE IN SPECIFICATIONS

Product specifications and accessories may be changed at any time based on improvements and other reasons. Consult with your OMRON representative at any time to confirm actual specifications of purchased product.

DIMENSIONS AND WEIGHTS

Dimensions and weights are nominal and are not to be used for manufacturing purposes, even when tolerances are shown.

ALL DIMENSIONS SHOWN ARE IN MILLIMETERS.

To convert millimeters into inches, multiply by 0.03937. To convert grams into ounces, multiply by 0.03527.

OMRON Corporation Industrial Automation Company Control Devices Division H.Q. Environment Business Department

2-2-1 Nishikusatsu, Kusatsu-shi,
Shiga, 525-0035 Japan
Tel: (81) 77-565-6501/Fax: (81) 77-565-7146

Regional Headquarters

OMRON EUROPE B.V.
Wegalaan 67-69-2132 JD Hoofddorp
The Netherlands
Tel: (31)2356-81-300/Fax: (31)2356-81-388

OMRON Industrial Automation Global: www.ia.omron.com

OMRON ELECTRONICS LLC
One Commerce Drive Schaumburg,
IL 60173-5302 U.S.A.
Tel: (1) 847-843-7900/Fax: (1) 847-843-7787

OMRON ASIA PACIFIC PTE. LTD.
No. 438A Alexandra Road # 05-05/08 (Lobby 2),
Alexandra Technopark, Singapore 119967
Tel: (65) 6835-3011/Fax: (65) 6835-2711

OMRON (CHINA) CO., LTD.
Room 2211, Bank of China Tower,
200 Yin Cheng Zhong Road,
PuDong New Area, Shanghai, 200120, China
Tel: (86) 21-5037-2222/Fax: (86) 21-5037-2200

Authorized Distributor:

© OMRON Corporation 2009 All Rights Reserved.
In the interest of product improvement,
specifications are subject to change without notice.

CSM_1_2_1010
Cat. No. L117-E1-01

Printed in Japan
0909