

# BLP9LA25S; BLP9LA25SG

Power LDMOS transistor

Rev. 3 — 12 January 2023

AMPLEON

Product data sheet

## 1. Product profile

### 1.1 General description

This 13.6 V 25 W device is designed for land mobile radio (LMR) applications supporting the frequency range from HF up to 941 MHz.

**Table 1. Application performance**

Typical RF performance at  $T_{case} = 25\text{ }^{\circ}\text{C}$ ;  $V_{DS} = 13.6\text{ V}$ ; in a class-AB demo circuit.

Test signal	f	$I_{DQ}$	$P_{L(AV)}$	$G_p$	$\eta_D$	$RL_{in}$
	(MHz)	(mA)	(W)	(dB)	(%)	(dB)
CW	380 to 460	42	31	>16.5	>49.0	-7.3
	520	45	25	18.4	72.0	-15
	740 to 800	100	25	>15.7	>61.5	-5.7
	800 to 870	100	25	>14.2	>64.7	-5.3

### 1.2 Features and benefits

- High efficiency
- Integrated dual sided ESD protection
- Extreme ruggedness 65 : 1
- High power gain
- Excellent reliability
- Wideband
- High linearity
- For RoHS compliance see the product details on the Ampleon website

### 1.3 Applications

- TETRA, SSB and LTE mobile radio applications in VHF and UHF bands
- Wideband radio application, frequency range from 380 MHz to 460 MHz and from 800 MHz to 870 MHz

## 2. Pinning information

Table 2. Pinning

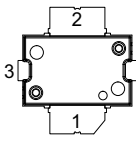
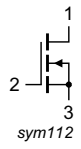
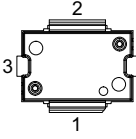
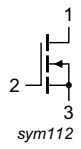
Pin	Description	Simplified outline	Graphic symbol
<b>BLP9LA25S (TO-270-2F-1)</b>			
1	drain		 sym112
2	gate		
3	source <a href="#">[1]</a>		
<b>BLP9LA25SG (TO-270-2G-1)</b>			
1	drain		 sym112
2	gate		
3	source <a href="#">[1]</a>		

[1] Connected to flange.

## 3. Ordering information

Table 3. Ordering information

Package name	Orderable part number	12NC	Packing description	Min. orderable quantity (pieces)
TO-270-2F-1	BLP9LA25SZ	9349 602 91515	TR13; 500-fold; 24 mm; dry pack	500
	BLP9LA25SXY	9349 602 91538	TR7; 100-fold; 24 mm; dry pack	100
TO-270-2G-1	BLP9LA25SGZ	9349 603 15515	TR13; 500-fold; 24 mm; dry pack	500
	BLP9LA25SGXY	9349 603 15538	TR7; 100-fold; 24 mm; dry pack	100

## 4. Limiting values

Table 4. Limiting values

In accordance with the Absolute Maximum Rating System (IEC 60134).

Symbol	Parameter	Conditions	Min	Max	Unit
$V_{DS}$	drain-source voltage		-	40	V
$V_{GS}$	gate-source voltage		-5	+13	V
$T_{stg}$	storage temperature		-65	+150	°C
$T_j$	junction temperature	<a href="#">[1]</a>	-	225	°C

[1] Continuous use at maximum temperature will affect the reliability, for details refer to the online MTF calculator.

## 5. Thermal characteristics

Table 5. Thermal characteristics

Symbol	Parameter	Conditions	Typ	Unit
$R_{th(j-c)}$	thermal resistance from junction to case	$T_{case} = 80\text{ °C}; V_{DS} = 13.6\text{ V}; P_L = 25\text{ W}$	0.6	K/W

## 6. Characteristics

Table 6. DC characteristics

$T_j = 25\text{ °C};$  unless otherwise specified.

Symbol	Parameter	Conditions	Min	Typ	Max	Unit
$V_{(BR)DSS}$	drain-source breakdown voltage	$V_{GS} = 0\text{ V}; I_D = 1.0\text{ mA}$	40	-	-	V
$V_{GS(th)}$	gate-source threshold voltage	$V_{DS} = 10\text{ V}; I_D = 100\text{ mA}$	1.5	2.0	2.5	V
$I_{DSS}$	drain leakage current	$V_{GS} = 0\text{ V}; V_{DS} = 13.6\text{ V}$	-	-	1.4	$\mu\text{A}$
$I_{DSX}$	drain cut-off current	$V_{GS} = V_{GS(th)} + 3.75\text{ V}; V_{DS} = 10\text{ V}$	-	19	-	A
$I_{GSS}$	gate leakage current	$V_{GS} = 11\text{ V}; V_{DS} = 0\text{ V}$	-	-	140	nA
$g_{fs}$	forward transconductance	$V_{DS} = 10\text{ V}; I_D = 100\text{ mA}$	-	0.93	-	S
$R_{DS(on)}$	drain-source on-state resistance	$V_{GS} = V_{GS(th)} + 3.75\text{ V}; I_D = 3.5\text{ A}$	-	128	-	$\text{m}\Omega$

Table 7. AC characteristics

$T_j = 25\text{ °C};$  unless otherwise specified.

Symbol	Parameter	Conditions	Min	Typ	Max	Unit
$C_{iss}$	input capacitance	$V_{GS} = 0\text{ V}; V_{DS} = 13.6\text{ V}; f = 1\text{ MHz}$	-	96.9	-	pF
$C_{oss}$	output capacitance	$V_{GS} = 0\text{ V}; V_{DS} = 13.6\text{ V}; f = 1\text{ MHz}$	-	50.6	-	pF
$C_{rss}$	reverse transfer capacitance	$V_{GS} = 0\text{ V}; V_{DS} = 13.6\text{ V}; f = 1\text{ MHz}$	-	0.86	-	pF

Table 8. RF characteristics

Test signal: CW at  $V_{DS} = 13.6\text{ V}; I_{Dq} = 45\text{ mA}; T_{case} = 25\text{ °C};$  unless otherwise specified; in a class-AB production circuit measured at frequencies of 520 MHz.

Symbol	Parameter	Conditions	Min	Typ	Max	Unit
$G_p$	power gain	$P_L = 25\text{ W}$	17.8	18.8	-	dB
$RL_{in}$	input return loss	$P_L = 25\text{ W}$	-	-18	-	dB
$\eta_D$	drain efficiency	$P_L = 25\text{ W}$	68	72	-	%

## 7. Test information

### 7.1 Ruggedness in class-AB operation

The BLP9LA25S and BLP9LA25SG are capable of withstanding a load mismatch corresponding to  $VSWR = 65 : 1$  through all phases under the following conditions:  $V_{DS} = 13.6\text{ V}; I_{Dq} = 45\text{ mA}; P_L = 25\text{ W (CW)}; f = 520\text{ MHz}.$

7.2 Test circuit

7.2.1 Test circuit  $f = 380 \text{ MHz to } 460 \text{ MHz}$

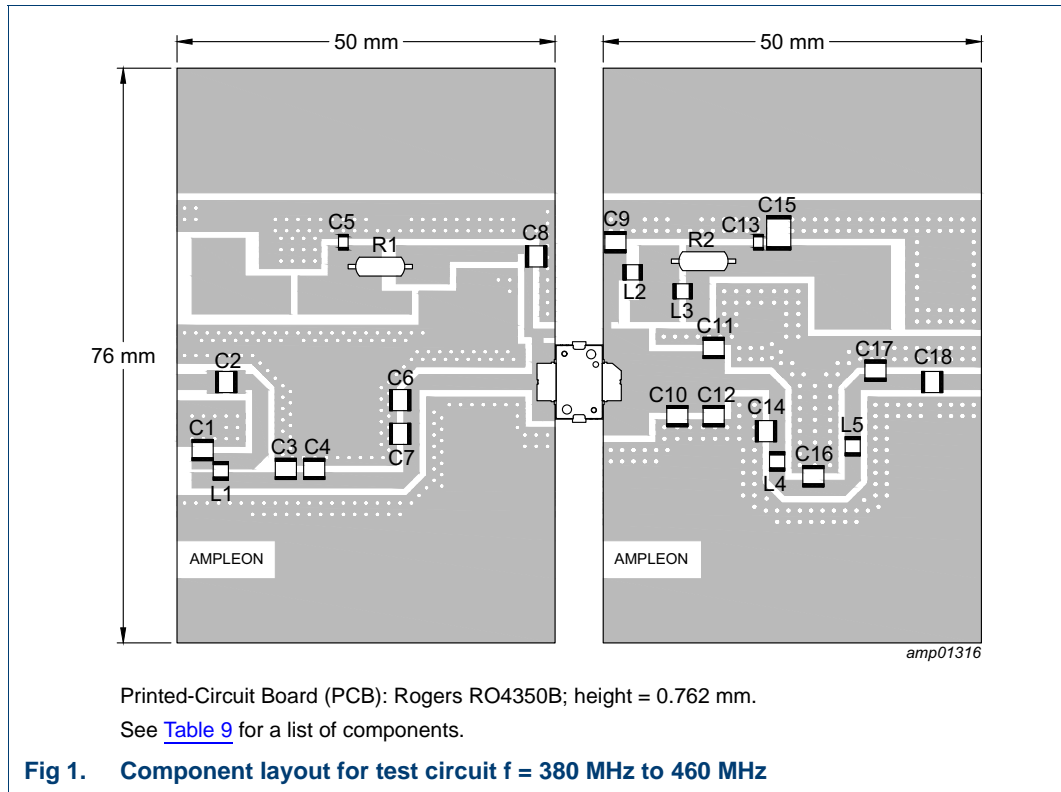

**Table 9. List of components**

See [Figure 1](#) for component layout.

Component	Description	Value	Remarks
C1	multilayer ceramic chip capacitor	9.1 pF	ATC 100B
C2	multilayer ceramic chip capacitor	100 pF	ATC 100B
C3	multilayer ceramic chip capacitor	6.8 pF	ATC 100B
C4	multilayer ceramic chip capacitor	15 pF	ATC 100B
C5	multilayer ceramic chip capacitor	100 nF, 50 V	
C6	multilayer ceramic chip capacitor	33 pF	ATC 100B
C7	multilayer ceramic chip capacitor	16 pF	ATC 100B
C8	multilayer ceramic chip capacitor	120 pF	ATC 100B
C9	multilayer ceramic chip capacitor	22 pF	ATC 100B
C10	multilayer ceramic chip capacitor	56 pF	ATC 100B
C11	multilayer ceramic chip capacitor	15 pF	ATC 100B
C12	multilayer ceramic chip capacitor	62 pF	ATC 100B
C13	multilayer ceramic chip capacitor	100 nF, 50 V	
C14	multilayer ceramic chip capacitor	27 pF	ATC 100B
C15	multilayer ceramic chip capacitor	4.7 $\mu$ F	
C16	multilayer ceramic chip capacitor	6.8 pF	ATC 100B

**Table 9. List of components ...continued**  
See [Figure 1](#) for component layout.

Component	Description	Value	Remarks
C17	multilayer ceramic chip capacitor	1.7 pF	ATC 100B
C18	multilayer ceramic chip capacitor	100 pF	ATC 100B
L1	inductor air core	~6.9 nH	
L2	inductor air core	~23 nH	
L3	inductor air core	~22 nH	
L4, L5	wire one turn	~0.4 nH	
R1	axial resistor	68 Ω	
R2	axial resistor	49 Ω	

**7.2.2 Test circuit f = 520 MHz**

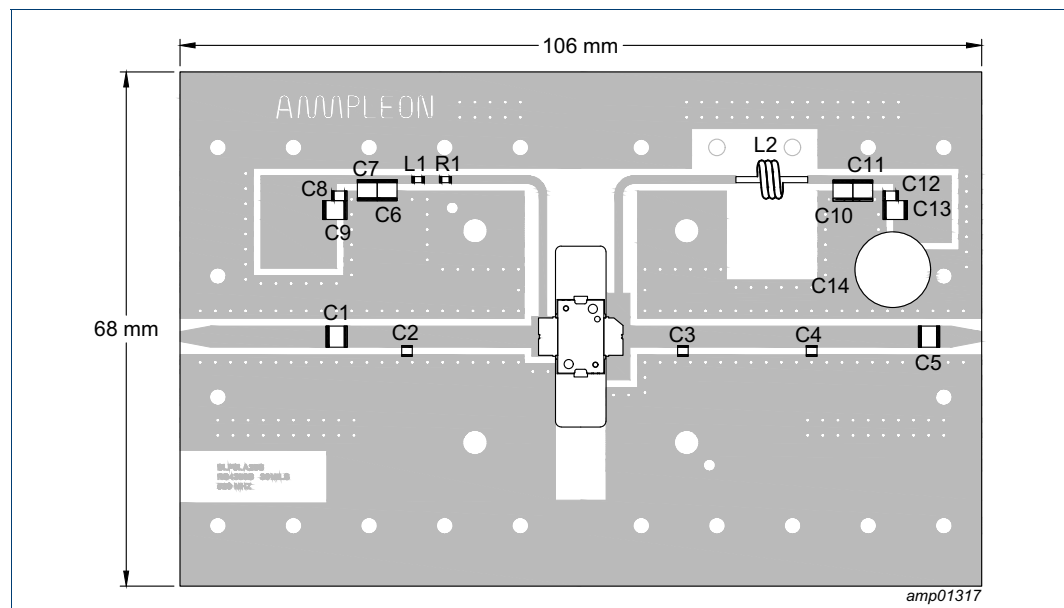

Printed-Circuit Board (PCB): Rogers RO4350B; height = 0.762 mm.  
See [Table 10](#) for a list of components.

**Fig 2. Component layout for test circuit f = 520 MHz**

**Table 10. List of components**  
See [Figure 2](#) for component layout.

Component	Description	Value	Remarks
C1	multilayer ceramic chip capacitor	11 pF	ATC 100B
C2	multilayer ceramic chip capacitor	24 pF	ATC 600F
C3	multilayer ceramic chip capacitor	24 pF	ATC 600F
C4	multilayer ceramic chip capacitor	10 pF	ATC 600F
C5	multilayer ceramic chip capacitor	15 pF	ATC 100B
C6, C10	multilayer ceramic chip capacitor	22 pF	ATC 100B
C7, C11	multilayer ceramic chip capacitor	1 nF	ATC 100B
C8, C12	multilayer ceramic chip capacitor	0.1 μF	GRM21BR71H104KA01L

**Table 10. List of components ...continued**  
See [Figure 2](#) for component layout.

Component	Description	Value	Remarks
C9, C13	multilayer ceramic chip capacitor	1 $\mu$ F	GRM32RR71H105KA01L
C14	electrolytic capacitor	1000 $\mu$ F, 63 V	
L1	wire wound inductor	43 nH	LQW18AN43NG80
L2	inductor air core	~53 nH	
R1	SMD	10 $\Omega$	

**7.2.3 Test circuit  $f = 740$  MHz to  $800$  MHz and  $f = 800$  MHz to  $870$  MHz**

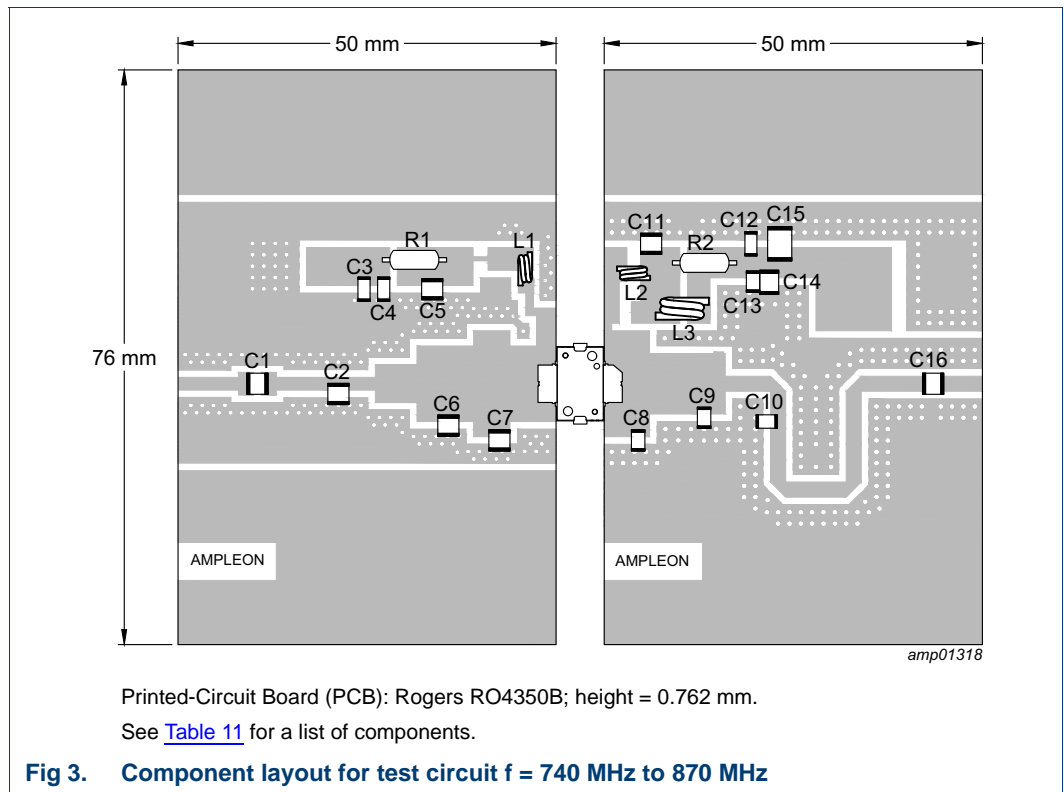

**Table 11. List of components**  
See [Figure 3](#) for component layout.

Component	Description	Value	Remarks
C1	multilayer ceramic chip capacitor	47 pF	ATC 100B
C2	multilayer ceramic chip capacitor	10 pF	ATC 100B
C3	multilayer ceramic chip capacitor	1 $\mu$ F	GRM31MR71E105KA01L
C4	multilayer ceramic chip capacitor	100 nF	C1206C104K1RAC
C5	multilayer ceramic chip capacitor	220 pF	ATC 100B
C6	multilayer ceramic chip capacitor	8.2 pF	ATC 100B
C7	multilayer ceramic chip capacitor	18 pF	ATC 100B
C8	multilayer ceramic chip capacitor	18 pF	ATC 800B
C9	multilayer ceramic chip capacitor	16 pF	ATC 800B

**Table 11. List of components ...continued**  
See [Figure 3](#) for component layout.

Component	Description	Value	Remarks
C10	multilayer ceramic chip capacitor	8.2 pF	ATC 800B
C11	multilayer ceramic chip capacitor	100 pF	ATC 100B
C12	multilayer ceramic chip capacitor	100 nF	C1206C104K1RAC
C13	multilayer ceramic chip capacitor	1 nF	ATC 100B
C14	multilayer ceramic chip capacitor	1 μF	GRM32RR71H105KA01L
C15	multilayer ceramic chip capacitor	10 μF, 50 V	
C16	multilayer ceramic chip capacitor	82 pF	ATC 800B
L1	inductor air core	~5 nH	
L2	inductor air core	~9 nH	
L3	inductor air core	~15 nH	
R1	axial resistor	68 Ω	
R2	axial resistor	10 Ω	

### 7.3 Graphical data

#### 7.3.1 1-Tone CW measurements (f = 380 MHz to 460 MHz)

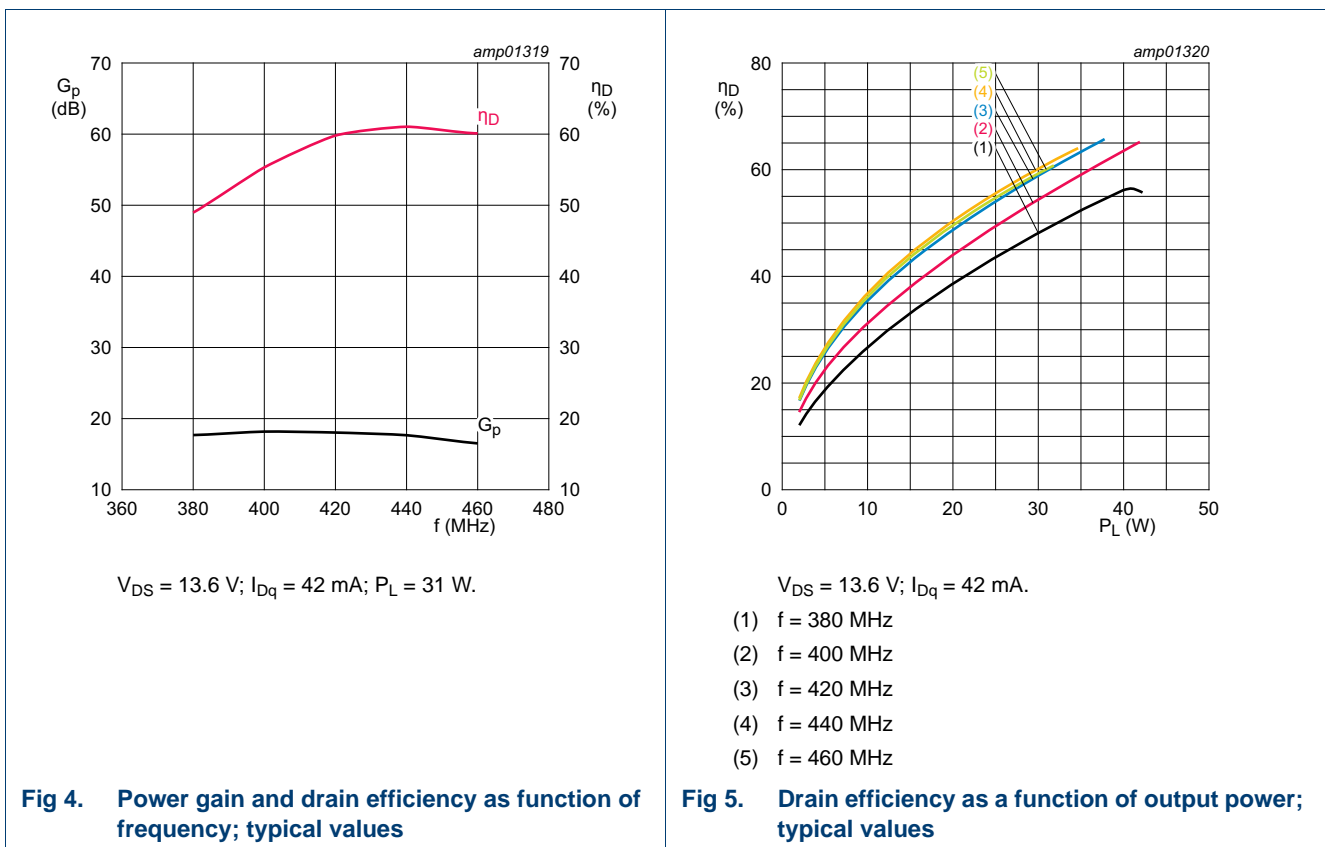

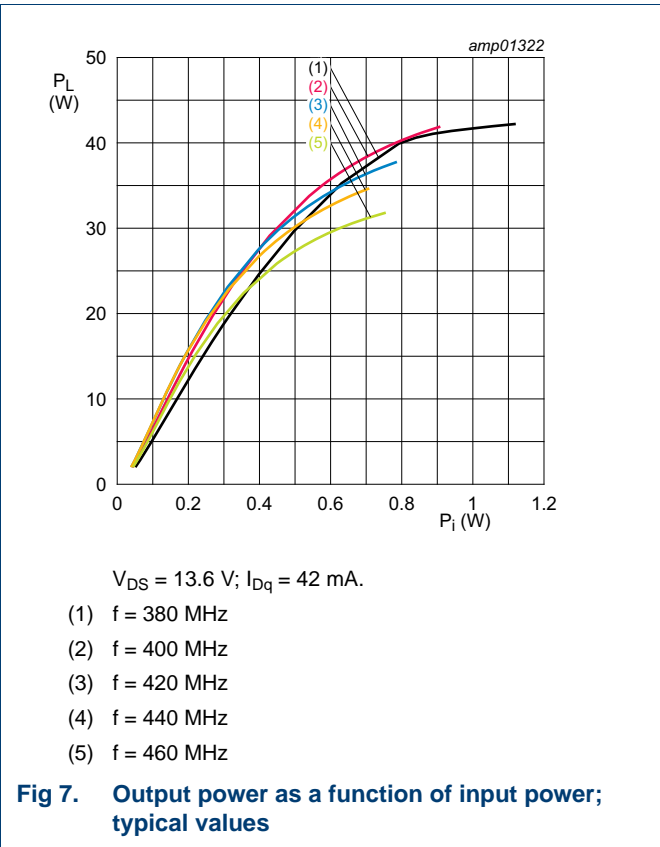
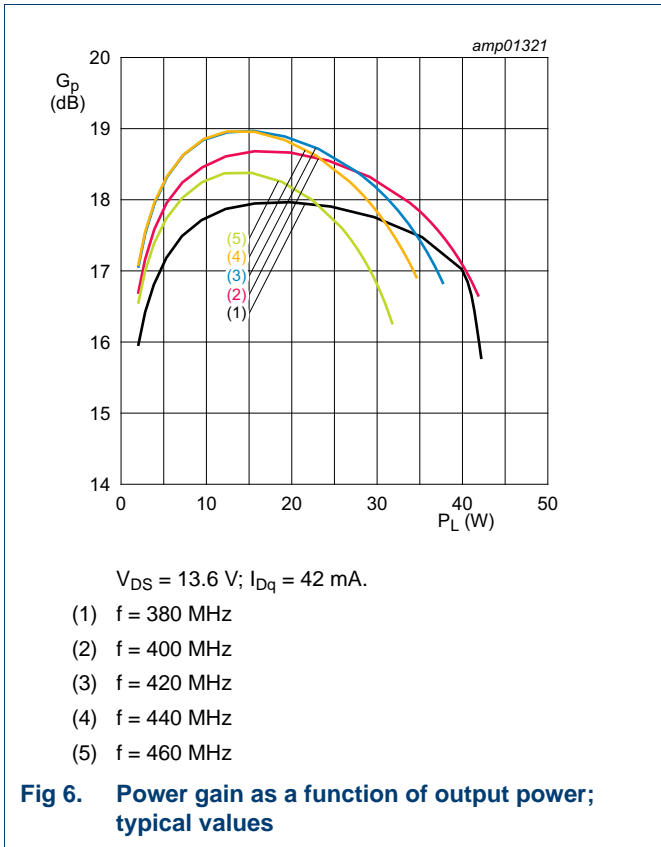

7.3.2 1-Tone CW measurements (f = 520 MHz)

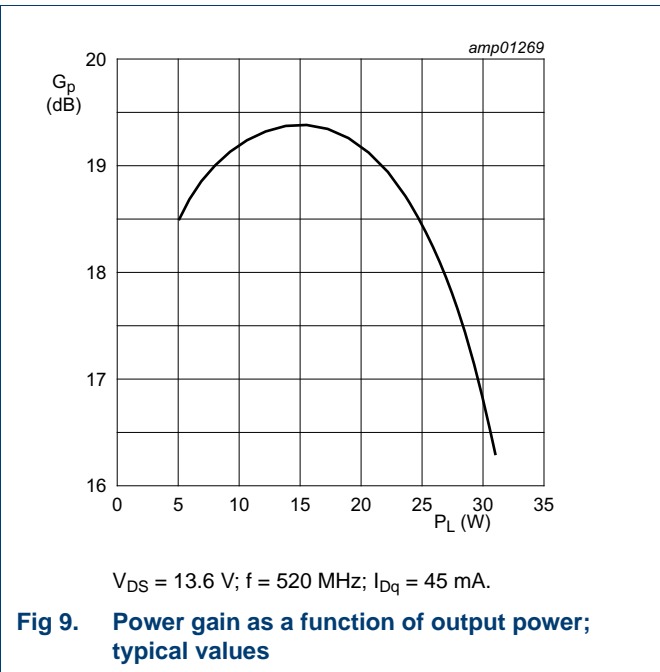
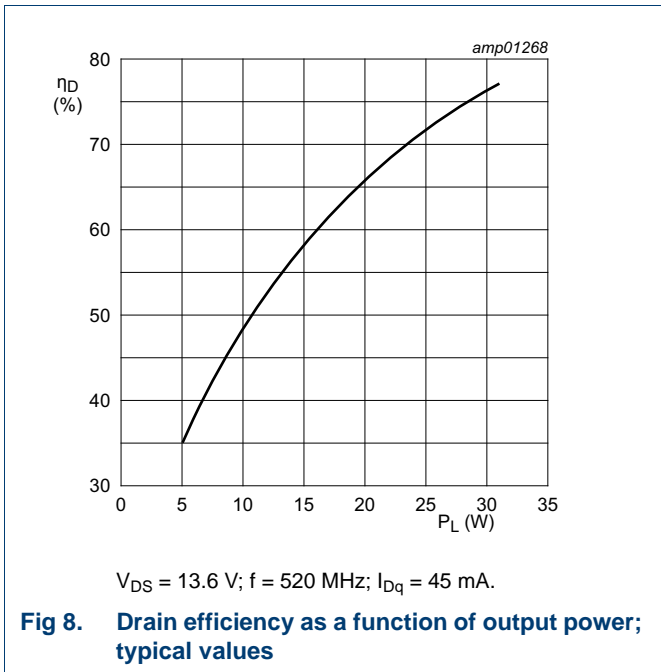



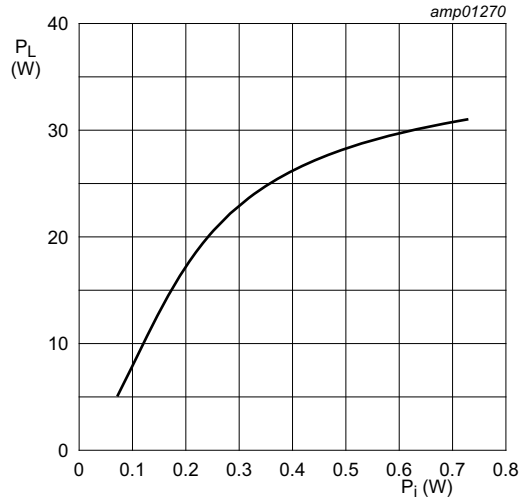

$V_{DS} = 13.6 \text{ V}$ ;  $f = 520 \text{ MHz}$ ;  $I_{Dq} = 45 \text{ mA}$ .

Fig 10. Output power as a function of input power; typical values

7.3.3 1-Tone CW measurements (f = 740 MHz to 800 MHz)

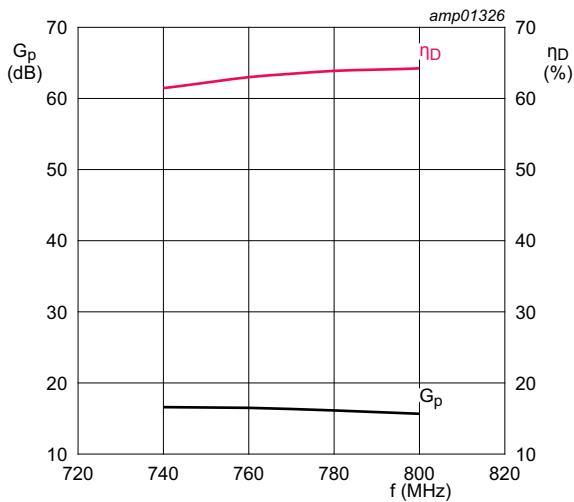

$V_{DS} = 13.6 \text{ V}$ ;  $I_{Dq} = 100 \text{ mA}$ ;  $P_L = 25 \text{ W}$ .

Fig 11. Power gain and drain efficiency as function of frequency; typical values

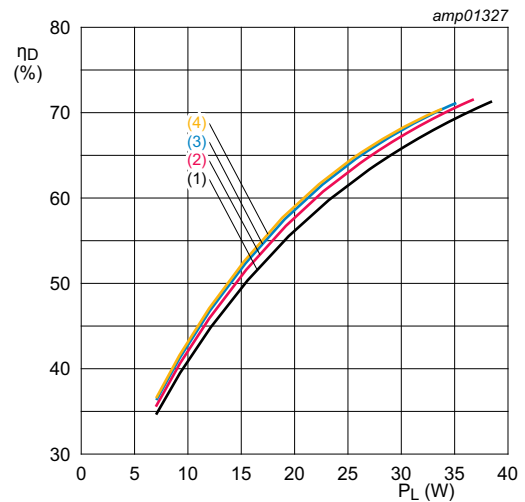

$V_{DS} = 13.6 \text{ V}$ ;  $I_{Dq} = 100 \text{ mA}$ .

- (1)  $f = 740 \text{ MHz}$
- (2)  $f = 760 \text{ MHz}$
- (3)  $f = 780 \text{ MHz}$
- (4)  $f = 800 \text{ MHz}$

Fig 12. Drain efficiency as a function of output power; typical values

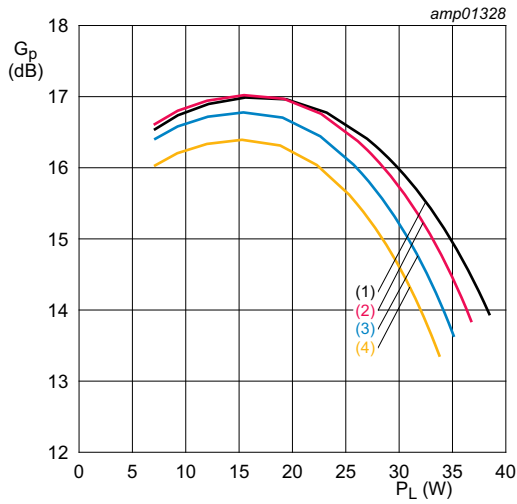

$V_{DS} = 13.6 \text{ V}; I_{Dq} = 100 \text{ mA}.$

- (1)  $f = 740 \text{ MHz}$
- (2)  $f = 760 \text{ MHz}$
- (3)  $f = 780 \text{ MHz}$
- (4)  $f = 800 \text{ MHz}$

**Fig 13. Power gain as a function of output power; typical values**

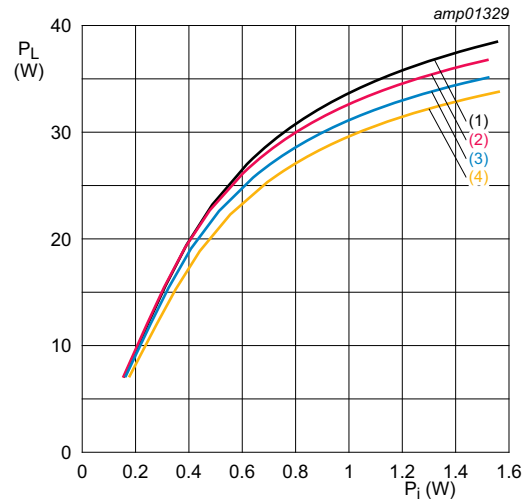

$V_{DS} = 13.6 \text{ V}; I_{Dq} = 100 \text{ mA}.$

- (1)  $f = 740 \text{ MHz}$
- (2)  $f = 760 \text{ MHz}$
- (3)  $f = 780 \text{ MHz}$
- (4)  $f = 800 \text{ MHz}$

**Fig 14. Output power as a function of input power; typical values**

7.3.4 2-Tone CW measurements (f = 740 MHz to 800 MHz)

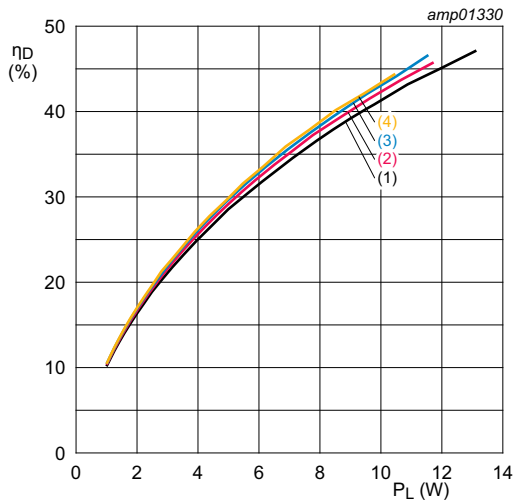

2-Tone signal with 100 kHz carrier separation:  
 $V_{DS} = 13.6\text{ V}$ ;  $I_{Dq} = 500\text{ mA}$ .

- (1) f = 740 MHz
- (2) f = 760 MHz
- (3) f = 780 MHz
- (4) f = 800 MHz

**Fig 15. Drain efficiency as a function of output power; typical values**

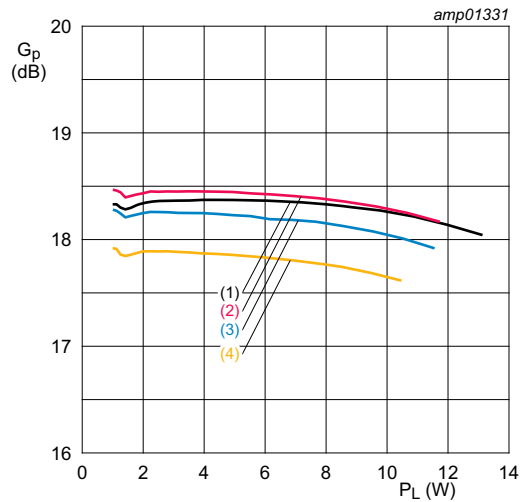

2-Tone signal with 100 kHz carrier separation:  
 $V_{DS} = 13.6\text{ V}$ ;  $I_{Dq} = 500\text{ mA}$ .

- (1) f = 740 MHz
- (2) f = 760 MHz
- (3) f = 780 MHz
- (4) f = 800 MHz

**Fig 16. Power gain as a function of output power; typical values**

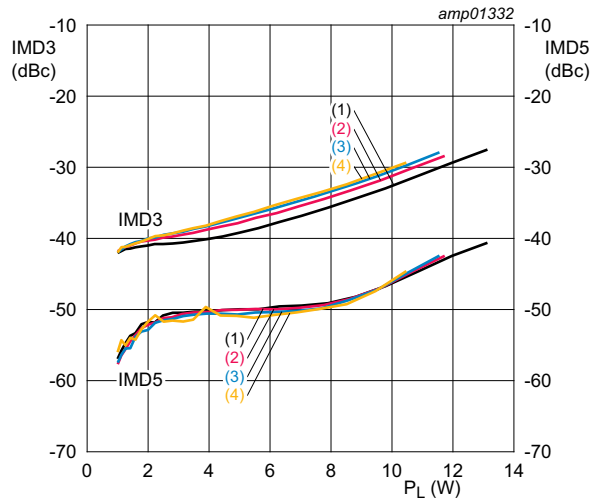

2-Tone signal with 100 kHz carrier separation:  $V_{DS} = 13.6\text{ V}$ ;  $I_{Dq} = 500\text{ mA}$ .

- (1) f = 740 MHz
- (2) f = 760 MHz
- (3) f = 780 MHz
- (4) f = 800 MHz

**Fig 17. Intermodulation distortion as a function of output power; typical values**

7.3.5 1-Tone CW measurements (f = 800 MHz to 870 MHz)

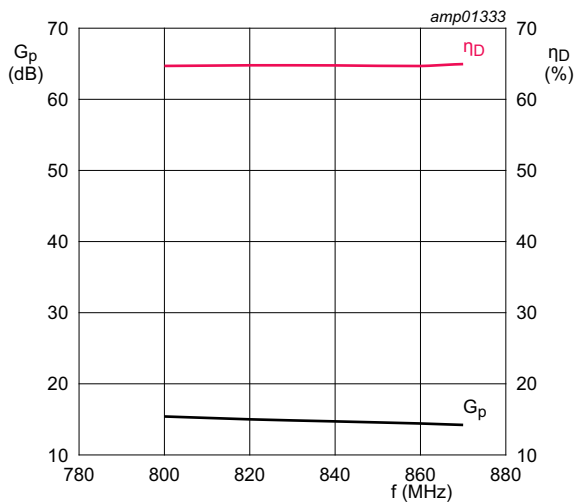

$V_{DS} = 13.6 \text{ V}; I_{Dq} = 100 \text{ mA}; P_L = 25 \text{ W}.$

Fig 18. Power gain and drain efficiency as function of frequency; typical values

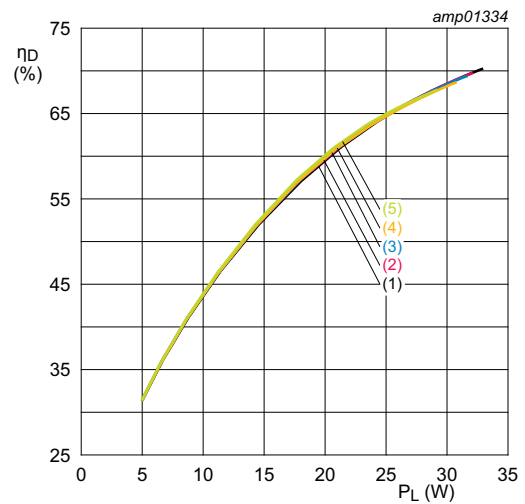

$V_{DS} = 13.6 \text{ V}; I_{Dq} = 100 \text{ mA}.$

- (1) f = 800 MHz
- (2) f = 820 MHz
- (3) f = 840 MHz
- (4) f = 860 MHz
- (5) f = 870 MHz

Fig 19. Drain efficiency as a function of output power; typical values

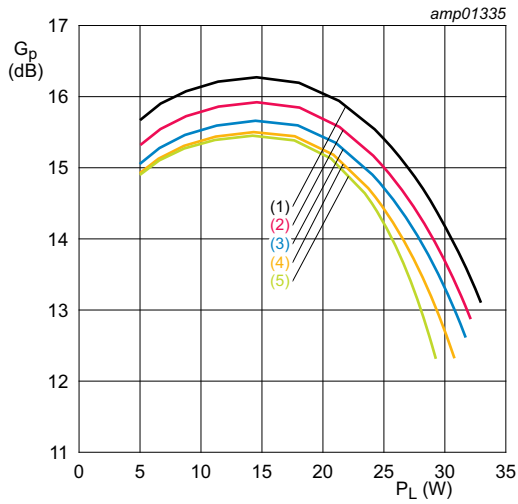

$V_{DS} = 13.6 \text{ V}; I_{Dq} = 100 \text{ mA}.$

- (1)  $f = 800 \text{ MHz}$
- (2)  $f = 820 \text{ MHz}$
- (3)  $f = 840 \text{ MHz}$
- (4)  $f = 860 \text{ MHz}$
- (5)  $f = 870 \text{ MHz}$

**Fig 20. Power gain as a function of output power; typical values**

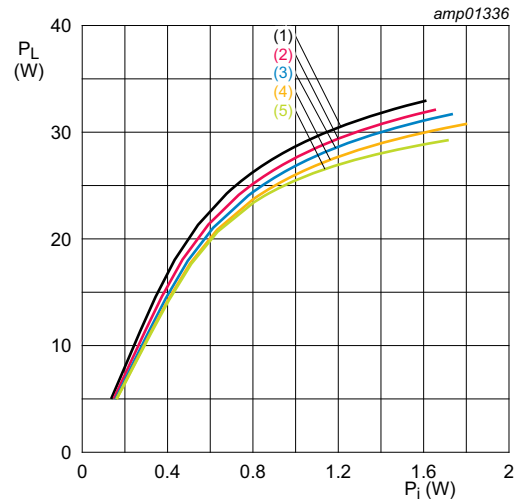

$V_{DS} = 13.6 \text{ V}; I_{Dq} = 100 \text{ mA}.$

- (1)  $f = 800 \text{ MHz}$
- (2)  $f = 820 \text{ MHz}$
- (3)  $f = 840 \text{ MHz}$
- (4)  $f = 860 \text{ MHz}$
- (5)  $f = 870 \text{ MHz}$

**Fig 21. Output power as a function of input power; typical values**

7.3.6 2-Tone CW measurements (f = 800 MHz to 870 MHz)

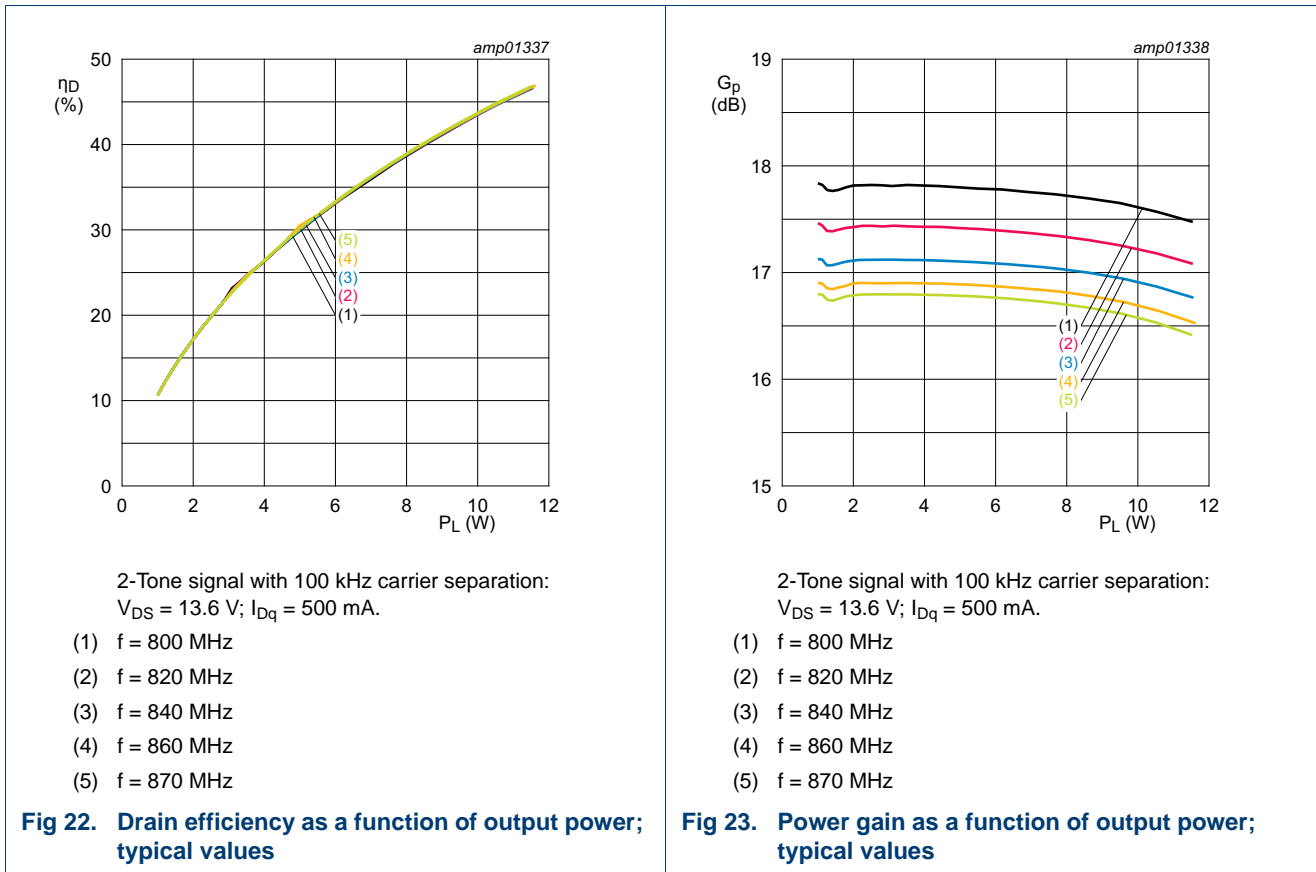

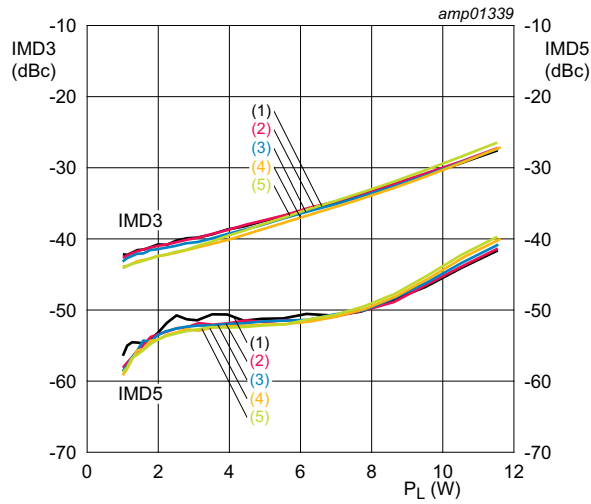

2-Tone signal with 100 kHz carrier separation:  $V_{DS} = 13.6\text{ V}$ ;  $I_{Dq} = 500\text{ mA}$ .

- (1)  $f = 800\text{ MHz}$
- (2)  $f = 820\text{ MHz}$
- (3)  $f = 840\text{ MHz}$
- (4)  $f = 860\text{ MHz}$
- (5)  $f = 870\text{ MHz}$

**Fig 24. Intermodulation distortion as a function of output power; typical values**

8. Package outline

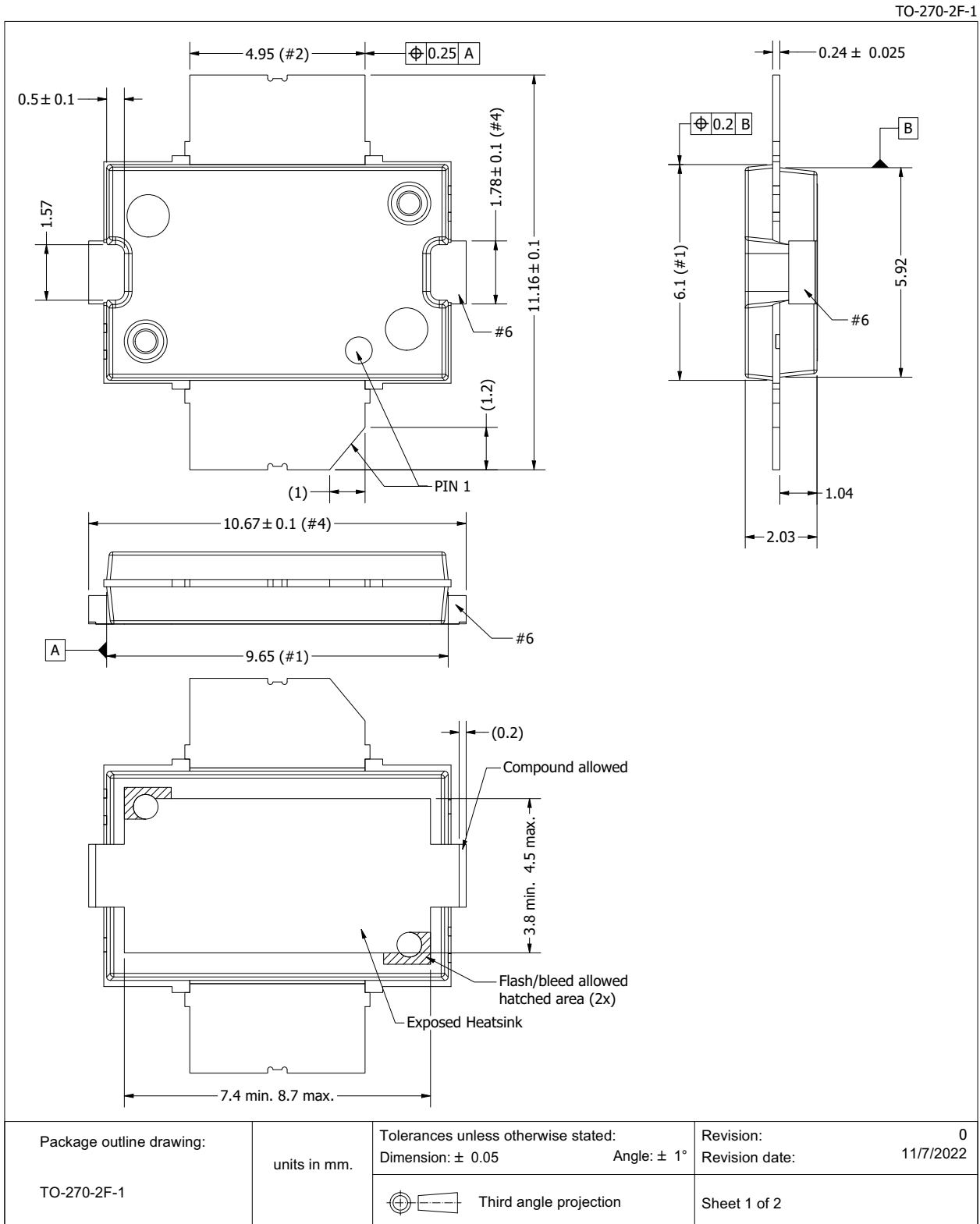

Fig 25. Package outline TO-270-2F-1 (sheet 1 of 2)



TO-270-2F-1

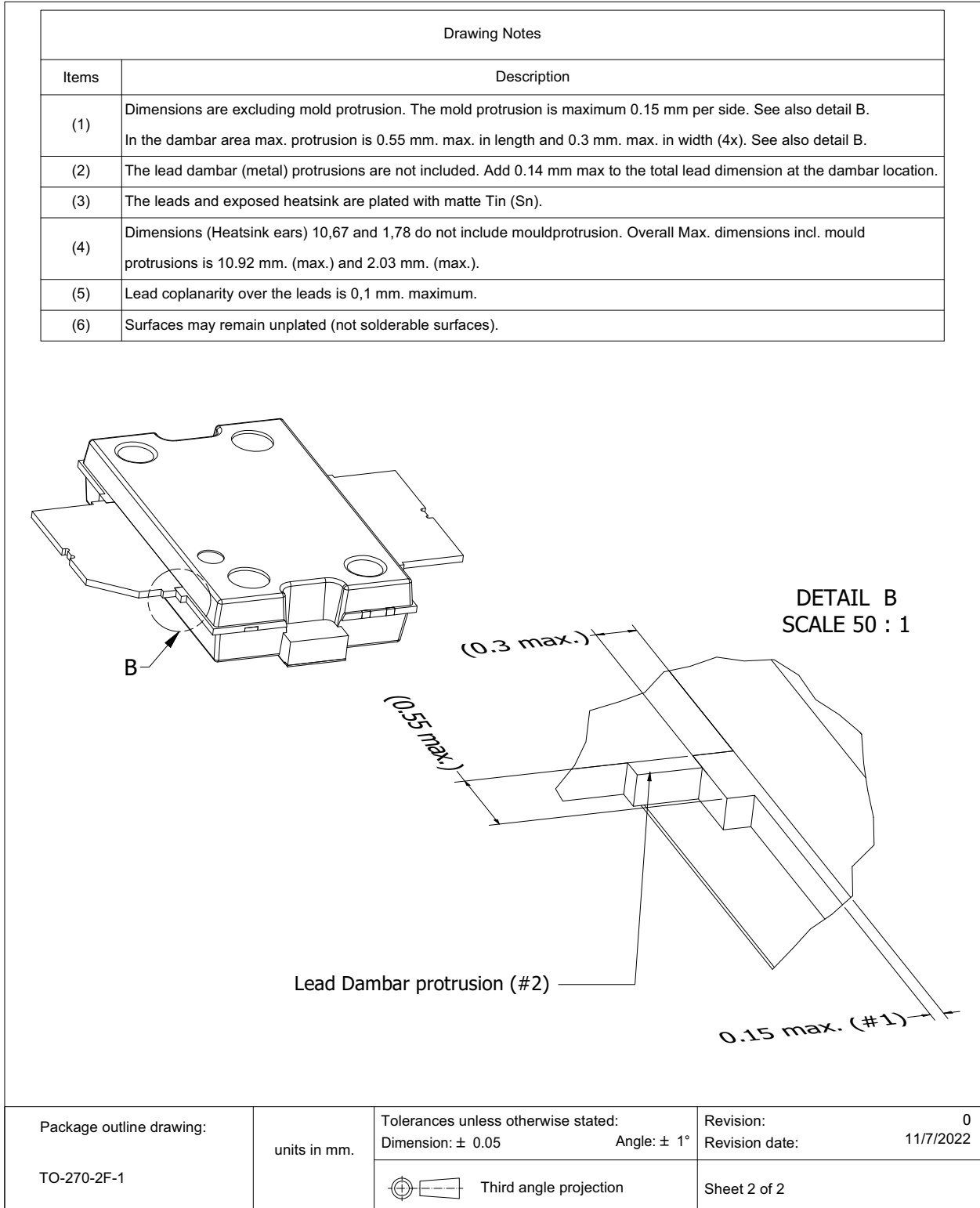

Fig 26. Package outline TO-270-2F-1 (sheet 2 of 2)

TO-270-2G-1

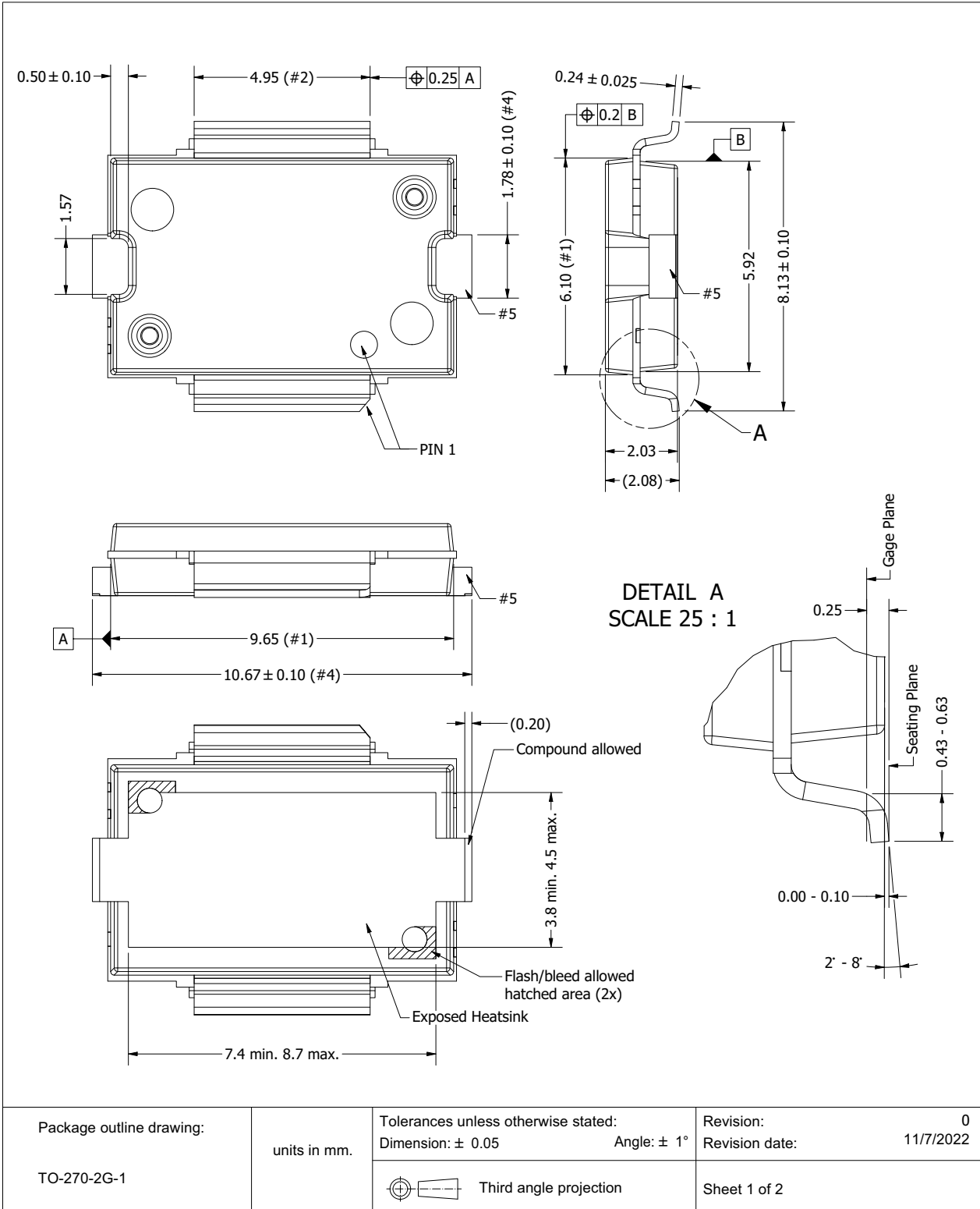
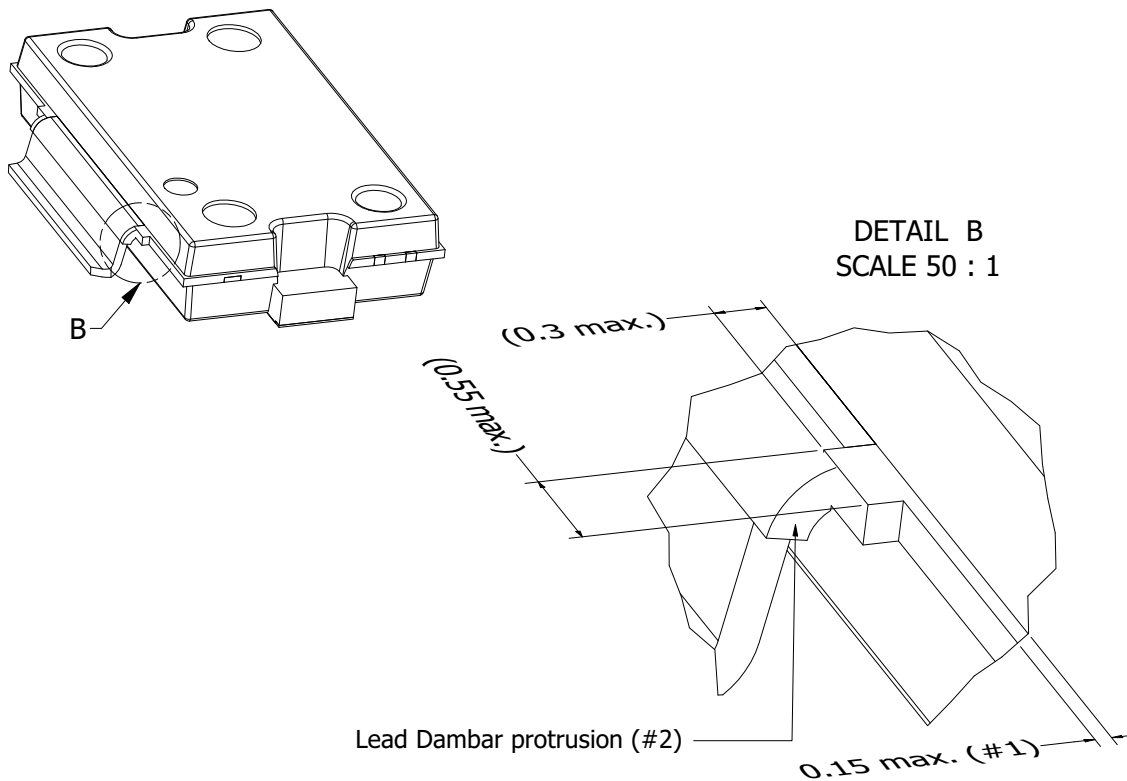

Fig 27. Package outline TO-270-2G-1 (sheet 1 of 2)

TO-270-2G-1

Drawing Notes	
Items	Description
(1)	Dimensions are excluding mold protrusion. The mold protrusion is maximum 0.15 mm per side. See also detail B. In the dambar area max. protrusion is 0.55mm max. in length and 0.3 mm max. in width (4x) See also detail B.
(2)	The lead dambar (metal) protrusions are not included. Add 0.14 mm max to the total lead dimension at the dambar location.
(3)	The leads and exposed heatsink are plated with matte Tin (Sn).
(4)	Dimensions (Heatsink ears) 10,67 and 1,78 do not include mouldprotrusion. Overall Max. dimensions incl. mould protrusions is 10,92 mm. (max.) and 2,03 mm. (max.).
(5)	Surfaces may remain unplated (not solderable surfaces).



Package outline drawing:	units in mm.	Tolerances unless otherwise stated:	Revision: 0
TO-270-2G-1		Dimension: $\pm 0.05$	Angle: $\pm 1^\circ$
		Third angle projection	Revision date: 11/7/2022
			Sheet 2 of 2

Fig 28. Package outline TO-270-2G-1 (sheet 2 of 2)

## 9. Handling information

**CAUTION**



This device is sensitive to ElectroStatic Discharge (ESD). Observe precautions for handling electrostatic sensitive devices.

Such precautions are described in the *ANSI/ESD S20.20*, *IEC/ST 61340-5*, *JESD625-A* or equivalent standards.

**Table 12. ESD sensitivity**

ESD model	Class
Charged Device Model (CDM); According to ANSI/ESDA/JEDEC standard JS-002	C2A <a href="#">[1]</a>
Human Body Model (HBM); According to ANSI/ESDA/JEDEC standard JS-001	2 <a href="#">[2]</a>

[1] CDM classification C2A is granted to any part that passes after exposure to an ESD pulse of 500 V.

[2] HBM classification 2 is granted to any part that passes after exposure to an ESD pulse of 2000 V.

## 10. Abbreviations

**Table 13. Abbreviations**

Acronym	Description
CW	Continuous Wave
ESD	ElectroStatic Discharge
HF	High Frequency
LDMOS	Laterally Diffused Metal-Oxide Semiconductor
LTE	Long Term Evolution
MTF	Median Time to Failure
RoHS	Restriction of Hazardous Substances
SSB	Single Side-Band
SMD	Surface Mounted Device
TETRA	TErrestrial Trunked Radio
UHF	Ultra High Frequency
VHF	Very High Frequency
VSWR	Voltage Standing Wave Ratio

## 11. Revision history

Table 14. Revision history

Document ID	Release date	Data sheet status	Change notice	Supersedes
BLP9LA25S_BLP9LA25SG v.3	20230112	Product data sheet	-	BLP9LA25S_BLP9LA25SG v.2
Modifications:	<ul style="list-style-type: none"> <li>• <a href="#">Table 2 on page 2</a>: package names changed from SOT1482-1 to TO-270-2F-1 and from SOT1483-1 to TO-270-2G-1</li> <li>• <a href="#">Table 3 on page 2</a>: package names changed from SOT1482-1 to TO-270-2F-1 and from SOT1483-1 to TO-270-2G-1</li> <li>• <a href="#">Table 5 on page 3</a>: value changed from 0.932 K/W to 0.6 K/W</li> <li>• <a href="#">Section 8 on page 16</a>: package outline drawing changed from SOT1482-1 to TO-270-2F-1 and from SOT1483-1 to TO-270-2G-1</li> <li>• <a href="#">Section 12 on page 22</a>: updated section</li> </ul>			
BLP9LA25S_BLP9LA25SG v.2	20210716	Product data sheet	-	BLP9LA25S_BLP9LA25SG v.1
BLP9LA25S_BLP9LA25SG v.1	20200616	Product data sheet	-	-

## 12. Legal information

### 12.1 Data sheet status

Document status <sup>[1][2]</sup>	Product status <sup>[3]</sup>	Definition
Objective [short] data sheet	Development	This document contains data from the objective specification for product development.
Preliminary [short] data sheet	Qualification	This document contains data from the preliminary specification.
Product [short] data sheet	Production	This document contains the product specification.

[1] Please consult the most recently issued document before initiating or completing a design.

[2] The term 'short data sheet' is explained in section "Definitions".

[3] The product status of device(s) described in this document may have changed since this document was published and may differ in case of multiple devices. The latest product status information is available on the Internet at URL <http://www.ampleon.com>.

### 12.2 Definitions

**Draft** — The document is a draft version only. The content is still under internal review and subject to formal approval, which may result in modifications or additions. Ampleon does not give any representations or warranties as to the accuracy or completeness of information included herein and shall have no liability for the consequences of use of such information.

**Short data sheet** — A short data sheet is an extract from a full data sheet with the same product type number(s) and title. A short data sheet is intended for quick reference only and should not be relied upon to contain detailed and full information. For detailed and full information see the relevant full data sheet, which is available on request via the local Ampleon sales office. In case of any inconsistency or conflict with the short data sheet, the full data sheet shall prevail.

**Product specification** — The information and data provided in a Product data sheet shall define the specification of the product as agreed between Ampleon and its customer, unless Ampleon and customer have explicitly agreed otherwise in writing. An agreement according to which the functions and qualities of Ampleon products exceed those described in the Product data sheet is invalid.

### 12.3 Disclaimers

**Maturity** — After the relevant product(s) have passed the Release Gate in Ampleon's release process, Ampleon will confirm the final version in writing.

**Limited warranty and liability** — Ampleon uses its best efforts to keep the information in this document accurate and reliable. However, Ampleon gives no representations or warranties, expressed or implied, as to the accuracy or completeness of such information and assumes no liability for the consequences of the use of such information. Ampleon is not liable for content provided by an external information source.

In no event and irrespective of the legal basis (contract, tort (including negligence) statutory liability, misrepresentation, indemnity or any other area of law) shall Ampleon be liable for any indirect, incidental, punitive, special or consequential damages (including but without limitation loss of profit or revenue, loss of use or loss of production, loss of data, cost of capital, cost of substitute goods, property damage external to the Ampleon products and any damage, expenditure or loss arising out of such damage, business interruption, costs related to the removal or replacement of any products or rework charges) or any of the foregoing suffered by any third party.

Notwithstanding any damages that customer might incur for any reason whatsoever, Ampleon's aggregate and cumulative liability towards customer for the products described herein shall be limited in accordance with the *Terms and conditions of commercial sale* of Ampleon.

**Right to make changes** — Ampleon reserves the right to change information including but without limitation specifications and product descriptions published in this document at any time and without notice. This document supersedes and replaces all information regarding these products supplied prior to the publication hereof.

**Suitability for use** — Ampleon products are not designed, authorized or warranted to be suitable for use in life support, life-critical or safety-critical systems or equipment, nor in applications where failure or malfunction of an Ampleon product can reasonably be expected to result in personal injury, death or severe property or environmental damage. Insofar as a customer or another party nevertheless uses Ampleon products unlawfully for such purposes, Ampleon and its suppliers are not liable for any damages.

**Applications** — Applications that are described herein for any of these products are for illustrative purposes only. Ampleon makes no representation or warranty that such applications will be suitable for the specified use without further testing or modification.

Customers are responsible for the design and operation of their applications and products using Ampleon products, and Ampleon is not liable for any assistance with applications or customer product design. It is customer's sole responsibility to determine whether the Ampleon product is suitable and fit for the customer's applications and products planned, as well as for the planned application and use of customer's third party customer(s). Customers shall provide appropriate design and operating safeguards to minimize the risks associated with their applications and products.

Ampleon is not liable related to any default, damage, costs or problem which is based on any weakness or default in the customer's applications or products, or the application or use by customer's third party customer(s). Customer is responsible for and shall do all necessary testing for the customer's applications and products using Ampleon products in order to avoid a default of the applications and the products or of the application or use by customer's third party customer(s). Ampleon is not liable in this respect.

**Limiting values** — Stress above one or more limiting values (as defined in the Absolute Maximum Ratings System of IEC 60134) will cause permanent damage to the device. Limiting values are stress ratings only and (proper) operation of the device at these or any other conditions above those given in the Recommended operating conditions section (if present) or the Characteristics sections of this document is not guaranteed. Constant or repeated exposure to limiting values will permanently and irreversibly affect the quality and reliability of the device.

**Terms and conditions of commercial sale** — Ampleon products are sold subject to the general terms and conditions of commercial sale, as published at <http://www.ampleon.com/terms>, unless otherwise agreed in a valid written individual agreement. In the event of signing an individual agreement the terms and conditions of the respective agreement shall apply. Ampleon hereby expressly objects to and rejects the validity of customer's terms and conditions regarding the purchase of Ampleon products by customer.

**No offer to sell or license** — Nothing in this document may be interpreted or construed as an offer to sell products that is open for acceptance or the grant, conveyance or implication of any license under any copyrights, patents or other industrial or intellectual property rights.

**Export control** — This document as well as the item(s) described herein may be subject to export control regulations. Export might require a prior authorization from competent authorities.

**Non-automotive qualified products** — Unless this data sheet expressly states that this specific Ampleon product is automotive qualified, the product is not suitable for automotive use. It is neither qualified nor tested in accordance with automotive testing or application requirements. Ampleon is not liable for inclusion and/or use of non-automotive qualified products in automotive equipment or applications.

In the event that customer breaches this and uses the products for design and use in automotive applications in accordance with automotive specifications and standards, (a) Ampleon gives no warranty, representation

or other guarantees of any kind with respect to such automotive applications, use and specifications, and (b) such use is solely and exclusively at customer's own risk, and (c) customer fully indemnifies Ampleon against any and all liability, damages or failed product claims, including against third parties, arising out of customer's design and use of the product for automotive applications.

**Translations** — A non-English (translated) version of a document is for reference only. The English version shall prevail in case of any discrepancy between the translated and English versions.

## 12.4 Trademarks

Notice: All referenced brands, product names, service names and trademarks are the property of their respective owners.

## 13. Contact information

---

For more information, please visit: <http://www.ampleon.com>

For sales office addresses, please visit: <http://www.ampleon.com/sales>

14. Contents

1 **Product profile** . . . . . 1

1.1 General description . . . . . 1

1.2 Features and benefits . . . . . 1

1.3 Applications . . . . . 1

2 **Pinning information** . . . . . 2

3 **Ordering information** . . . . . 2

4 **Limiting values** . . . . . 2

5 **Thermal characteristics** . . . . . 3

6 **Characteristics** . . . . . 3

7 **Test information** . . . . . 3

7.1 Ruggedness in class-AB operation . . . . . 3

7.2 Test circuit . . . . . 4

7.2.1 Test circuit f = 380 MHz to 460 MHz . . . . . 4

7.2.2 Test circuit f = 520 MHz . . . . . 5

7.2.3 Test circuit f = 740 MHz to 800 MHz and  
f = 800 MHz to 870 MHz . . . . . 6

7.3 Graphical data . . . . . 7

7.3.1 1-Tone CW measurements (f = 380 MHz to  
460 MHz) . . . . . 7

7.3.2 1-Tone CW measurements (f = 520 MHz) . . . . . 8

7.3.3 1-Tone CW measurements (f = 740 MHz to  
800 MHz) . . . . . 9

7.3.4 2-Tone CW measurements (f = 740 MHz to  
800 MHz) . . . . . 11

7.3.5 1-Tone CW measurements (f = 800 MHz to  
870 MHz) . . . . . 12

7.3.6 2-Tone CW measurements (f = 800 MHz to  
870 MHz) . . . . . 14

8 **Package outline** . . . . . 16

9 **Handling information** . . . . . 20

10 **Abbreviations** . . . . . 20

11 **Revision history** . . . . . 21

12 **Legal information** . . . . . 22

12.1 Data sheet status . . . . . 22

12.2 Definitions . . . . . 22

12.3 Disclaimers . . . . . 22

12.4 Trademarks . . . . . 23

13 **Contact information** . . . . . 23

14 **Contents** . . . . . 24

Please be aware that important notices concerning this document and the product(s) described herein, have been included in section 'Legal information'.

© Ampleon Netherlands B.V. 2023. All rights reserved.

For more information, please visit: <http://www.ampleon.com>  
For sales office addresses, please visit: <http://www.ampleon.com/sales>

Date of release: 12 January 2023

Document identifier: BLP9LA25S\_BLP9LA25SG