

Low-Jitter LVPECL Crystal Oscillator

Features

- Low-jitter crystal oscillator (XO)
- Less than 1 ps typical root mean square (RMS) phase jitter
- Low-voltage positive emitter coupled logic (LVPECL) output
- Output frequency from 50 MHz to 690 MHz
- Factory-configured or field-programmable
- Integrated phase-locked loop (PLL)
- Can be configured as four different devices
- Supply voltage: 3.3 V or 2.5 V
- Pb-free chip carrier (LCC): 5.0 mm × 3.2 mm for CY2X014 and 7.0 mm × 5.0 mm for CY2X0147
- Commercial and industrial temperature ranges

Functional Description

The CY2X014/CY2X0147 device is a high-performance and high-frequency XO. The device uses a Cypress proprietary low-noise PLL to synthesize the frequency from an integrated crystal.

The CY2X014/CY2X0147 device is available as a factory-configured device or as a field-programmable device. Factory-configured devices are configured for general use or they can be customer-specific. The same CY2X014/CY2X0147 can be configured as four different device types as mentioned in the [Logic Block Diagram](#).

For a complete list of related documentation, [click here](#).

Logic Block Diagram

Device Type 1: High-performance LVPECL crystal oscillator with Output Enable

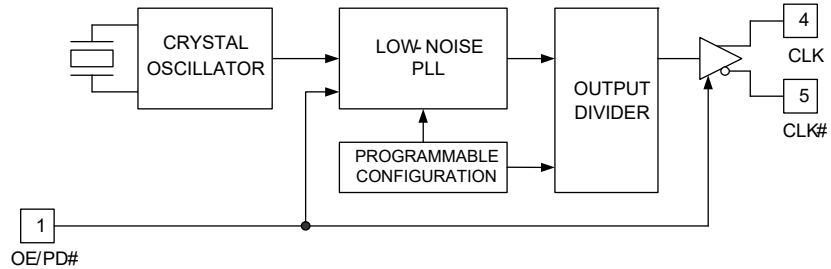

Device Type 2: High-performance LVPECL crystal oscillator with frequency margining - I²C control

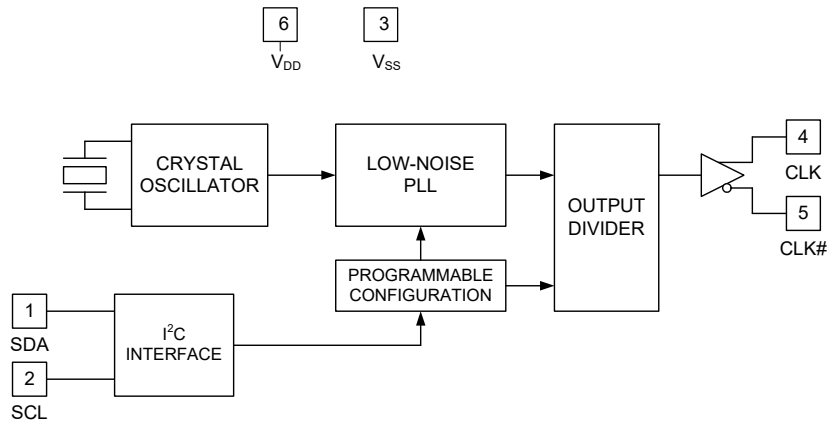

Device Type 3: High-performance LVPECL crystal oscillator with frequency margining - Frequency Select

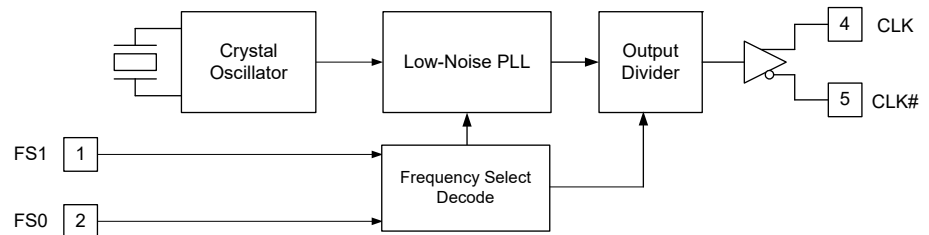

Device Type 4: High-performance LVPECL voltage-controlled crystal oscillator

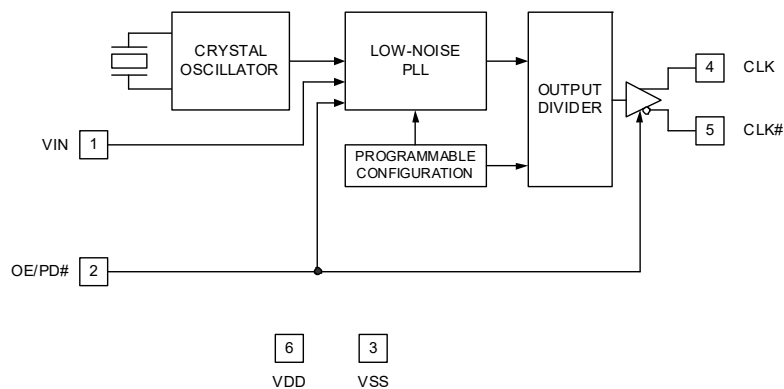

Contents

Pinout	4	Random Read	9
Pin Definitions	4	Sequential Read	9
Functional Overview	5	Serial Programming Interface	
Device Type 1	5	Timing Specifications	10
Device Type 2	5	Absolute Maximum Conditions	11
Device Type 3	5	Operating Conditions	11
Device Type 4	5	DC Electrical Characteristics	12
Programming Description	6	Termination Circuits	12
Field-Programmable CY2X014F/CY2X0147F	6	AC Electrical Characteristics	13
Factory Configured CY2X014/CY2X0147	6	Switching Waveforms	14
Programming Variables	6	Typical Output Characteristics	15
Output Frequency	6	Ordering Information	16
Pin 1: Output Enable (OE) or Power-Down (PD#)	6	Possible Configurations	16
Industrial versus Commercial Device Performance	6	Ordering Code Definitions	16
Absolute Pull Range	6	Package Diagrams	17
Memory Map	7	Acronyms	19
Serial Interface Protocol and Timing	7	Document Conventions	19
Device Address	8	Units of Measure	19
Data Valid	8	Document History Page	20
Data Frame	8	Sales, Solutions, and Legal Information	21
Acknowledge Pulse	9	Worldwide Sales and Design Support	21
Write Operations	9	Products	21
Writing Individual Bytes	9	PSoC® Solutions	21
Writing Multiple Bytes	9	Cypress Developer Community	21
Read Operations	9	Technical Support	21
Current Address Read	9		

Pinout

Figure 1. 6-pin Ceramic LCC pinout

Device Type 1: High Performance LVPECL Crystal Oscillator with Output Enable:

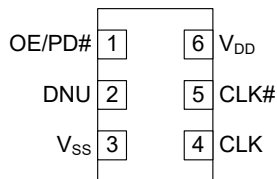

Device Type 2: High Performance LVPECL Crystal Oscillator with Frequency Margining - I²C control

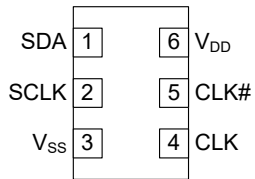

Device Type 3: High Performance LVPECL Crystal Oscillator with Frequency Margining - Frequency Select

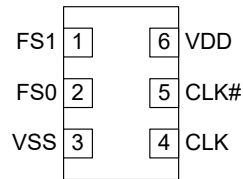

Device Type 4: High Performance LVPECL Voltage Controlled Crystal Oscillator

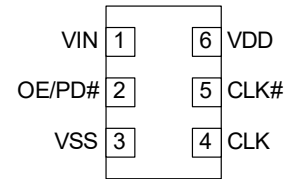

Pin Definitions

6-pin Ceramic LCC

Name	Device Type 1	Device Type 2	Device Type 3	Device Type 4	I/O Type	Description
OE/PD#	1	N/A	N/A	2	CMOS input	Output enable pin: Active HIGH. If OE = 1, CLK is enabled. Power-down pin: Active LOW. If PD# = 0, the device is powered down and the clock is disabled. The functionality of this pin is programmable
CLK, CLK#	4,5	4,5	4,5	4,5	LVPECL output	Differential output clock
DNU	2	N/A	N/A	N/A	–	Do not use: DNU pins are electrically connected but perform no function
V _{DD}	6	6	6	6	Power	Supply voltage: 2.5 V or 3.3 V
V _{SS}	3	3	3	3	Power	Ground
FS1, FS0	N/A	N/A	1,2	N/A	CMOS input	Frequency Select
SDA	N/A	1	N/A	N/A	I/O	I ² C Serial Data
SCLK	N/A	2	N/A	N/A	CMOS input	I ² C Serial Clock
VIN	N/A	N/A	N/A	1	Analog input	VCXO control voltage, positive slope

Functional Overview

Device Type 1

Device Type 1 is a simple crystal oscillator with one output frequency. Pin 1 can be programmed either as OE or PD#. The OE function is used to enable or disable the CLK output whereas the PD# function places the device in a low-power state.

Device Type 2

Device Type 2 has an I²C bus serial interface [1], which is used to change the output frequency.

The CY2X014/CY2X0147 device is configured for four frequencies. At power-on, the four configurations are transparently loaded into an internal volatile memory which, in turn, controls the PLL. The user can switch between the four frequencies through the I²C bus. The user can also configure the CY2X014/CY2X0147 with new output frequencies by shifting new data into the internal memory.

Frequency margining is a common application for this feature. One frequency is used for the standard operating mode of the device, while additional frequencies are available for margin testing, either during product development or in-system manufacturing test.

Note that all configuration changes made using I²C are temporary and are lost when power is removed from the device. At power-on, the device returns to its original state.

The configuration for a particular frequency is stored in a 6-byte block of memory, known as a word. The CY2X014/CY2X0147 device has four such words, labeled 'Frequency Word 0' through 'Frequency Word 3'. An additional register byte contains a 2-bit field, which selects one of the four frequency words. By writing to this select byte, the user can switch back and forth between the four programmed frequencies. The select byte can be configured to select any of the four frequency words at power-on.

When changing the output frequency, the frequency transition is not guaranteed to be smooth. There can be frequency excursions beyond the start frequency and the new frequency. Glitches and runt pulses are possible, and time must be allowed for the PLL to relock.

If more than four frequencies are needed, the I²C bus can be used to change any of the four frequency words. When writing frequency words through I²C, the users should not change the currently selected word. Instead, write one of the three unselected words before changing the select byte to select that new word.

Figure 2 shows how the frequency words are arranged and selected.

Figure 2. Frequency Words

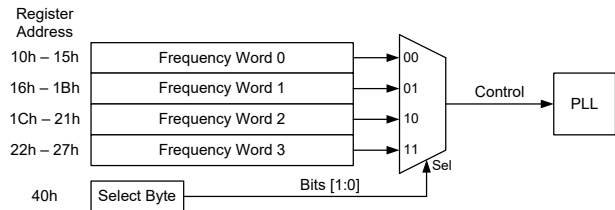

Device Type 3

The FS0 and FS1 pins select between four different output frequencies, as shown in Table 1. Frequency margining is a common application for this feature. One frequency is used for the standard operating mode of the device, while the other frequencies are available for margin testing, either during product development or in-system manufacturing test.

Table 1. Frequency Select

FS1	FS0	Output Frequency
0	0	Frequency 0
0	1	Frequency 1
1	0	Frequency 2
1	1	Frequency 3

When changing the output frequency, the frequency transition is not guaranteed to be smooth. There can be frequency excursions beyond the start frequency and the new frequency. Glitches and runt pulses are possible, and time must be allowed for the PLL to relock.

Device Type 4

Device Type 4 is a voltage-controlled crystal oscillator. It has a control voltage pin, VIN, which is an analog input used to adjust the output frequency. The nominal output frequency is defined when VIN = VDD,NOM/2. Increasing the voltage on VIN increases the output frequency, while decreasing the voltage on VIN decreases the output frequency. Any voltage between VSS and VDD is allowed on VIN. The voltage or frequency slope is very linear over most of the control voltage range.

Note

1. The serial interface is I²C Bus compliant with the following exceptions: SDA input leakage current, SDA input capacitance, SDA, and SCLK are clamped to V_{DD}, setup time, and output hold time.

Programming Description

CY2X014/CY2X0147 is a programmable device. Prior to being used in an application, it must be programmed with the output frequency and other variables described in [Programming Variables](#). Two device types are available, each with its own programming flow. They are described in the following sections.

Field-Programmable CY2X014F/CY2X0147F

Field-programmable devices are shipped unprogrammed and must be programmed before being installed on a PCB. Customers use the [CyClockWizard™](#) software to specify the device configuration and generate a joint electron devices engineering council (JEDEC - extension .jed) programming file. Programming of samples and prototype quantities is available using the [CyClockWizard](#) software along with a [CY3675-CLKMAKER1 CyClockMaker Clock Programmer Kit](#) and [CY3675-LCC6B](#) socket adapter. Cypress's value-added distribution partners also provide programming services. Field-programmable devices are designated with an 'F' in the part number. They are intended for quick prototyping and inventory reduction. You can generate JEDEC for these four devices using [CyClockWizard 1.0](#). However, while creating JEDEC or programming different device types, select different MPNs in the [CyClockWizard 1.0](#) software (see [Table 2](#)).

You can download the software and programmer kit hardware from www.cypress.com by clicking the hyperlinks in the previous paragraph.

Table 2. MPNs selection on CyClockWizard 1.0 Software

Device Type	MPN selection on CyClockWizard 1.0
Device Type 1	CY2X014
Device Type 2	CY2XF24
Device Type 3	CY2XF34
Device Type 3	Contact Local Cypress FAE

Factory Configured CY2X014/CY2X0147

For ready-to-use devices, the preconfigured CY2X014/CY2X0147 device is available for samples or orders, or you can request for a custom configuration. All requests are submitted to the local Cypress field application engineer (FAE) or sales representative. After the request is processed, the user receives a new part number, samples, and datasheet with the programmed values. This part number is used for additional sample requests and production orders. The CY2X014/CY2X0147 device is one-time programmable (OTP).

Programming Variables

Output Frequency

The CY2X014/CY2X0147 device can synthesize a frequency to a resolution of one part per million (ppm) but the actual accuracy of the output frequency is limited by the accuracy of the integrated reference crystal.

The CY2X014/CY2X0147 has an output frequency range of 50 MHz to 690 MHz, but the range is not continuous. The CY2X014/CY2X0147 cannot generate frequencies in the ranges of 521 MHz to 529 MHz and 596 MHz to 617 MHz.

Pin 1: Output Enable (OE) or Power-Down (PD#)

This function is only available in Device Type 1 and 4. Pin 1 (Device Type 1) or Pin 2 (Device type 2) is programmed as either OE or PD#. The OE function is used to enable or disable the CLK output quickly, but it does not reduce core power consumption. The PD# function places the device in a low-power state, but the wake-up takes longer because the PLL must reacquire the lock.

Industrial versus Commercial Device Performance

Industrial and commercial devices have different internal crystals. They have a potentially significant impact on performance levels for applications requiring the lowest possible phase noise. The [CyClockWizard 1.0](#) software allows the user to select between, and view the expected performance of, both options.

Absolute Pull Range

This is only applicable for Device Type 4. The pull range of the VCXO, measured in parts per million (ppm) is programmable. The configuration software allows the user to select one of seven possible absolute pull ranges (APR), ranging up to approximately ± 200 ppm. APR is the net pull range of the device, after subtracting frequency variability due to device variation, and temperature, voltage, and aging effects.

Table 3. Device Programming Variables

Variable	Device Type
Output frequency	Device Type 1 and 4
Pin 1 function (OE or PD#)	Device Type 1
Temperature range (commercial or industrial)	Device Type 1, 2, 3 and 4
Output frequency 0	Device Type 2 and 3
Output frequency 1	Device Type 2 and 3
Output frequency 2	Device Type 2 and 3
Output frequency 3	Device Type 2 and 3
Absolute pull range	Device Type 4
Pin 2 function (OE or PD#)	Device Type 4

Memory Map

Five fields can be written via the I²C bus. Four frequency words define the output frequency. As shown in Table 4, each of these words is a 6-byte field. When writing to a frequency word, all six bytes should be written. They may be written either as individual byte writes or as a block write. The currently selected frequency word should not be written to. All four words are symmetrical, meaning that a 6-byte value that is valid for one word is also valid for any of the other words, and produces the same frequency.

The fifth field is the select byte, located at byte address 40h. The value written into the two least significant bits determines the active frequency word. The other bits of the byte are reserved and must be written with the values indicated in the table. Users should never write to any address other than the 25 bytes described here.

Table 4. Frequency Words

Frequency Word	Byte Addresses (hex)	Word Select (Select Byte 40h)
0	10h to 15h	00
1	16h to 1Bh	01
2	1Ch to 21h	10
3	22h to 27h	11

Table 5. Register 40h: Select Byte

Bits	Default Value (binary)	Name	Description
7:2	000000	Reserved	Reserved. Always write this value.
1:0	User-defined	Word select	Selects the Frequency Word to determine the output frequency. 00 selects Word 0; 01 selects Word 1; 10 selects Word 2; 11 selects Word 3.

Serial Interface Protocol and Timing

The CY2X014/CY2X0147 device uses the SDA and SCLK pins for an I²C bus that operates up to 100 kbits/sec in read or write mode. The CY2X014/CY2X0147 device is always a slave on this bus, meaning that it never initiates a bus transaction. The basic write protocol is as follows:

Start Bit; 7-bit Device Address (DA); R/W Bit; Slave Clock Acknowledge (ACK); 8-bit Memory Address (MA); ACK; 8-bit Data in MA+1 if desired; ACK; 8-bit Data in MA+2; ACK; and so on, until STOP Bit. The basic serial format is illustrated in Figure 3.

Figure 3. Data Frame Architecture

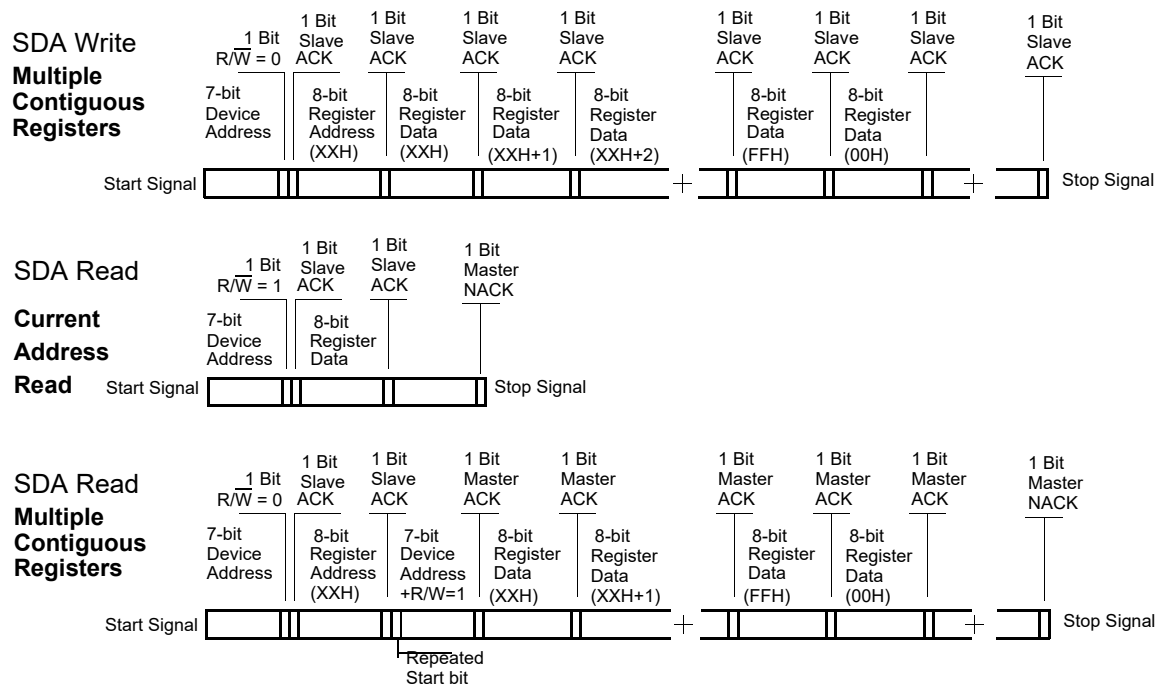

Device Address

The device I²C address is a 7-bit value. The default I²C address, which appears in [CyClockWizard](#) is 69H, which can be changed to any other value while generating configuration using [CyClockWizard](#). Note that the default address of the field-programmable (unprogrammed^[2]) devices is 69H.

Data Valid

Data is valid when the clock is HIGH and may only be transitioned when the clock is LOW, as illustrated in [Figure 4](#).

Figure 4. Data Valid and Data Transition Periods

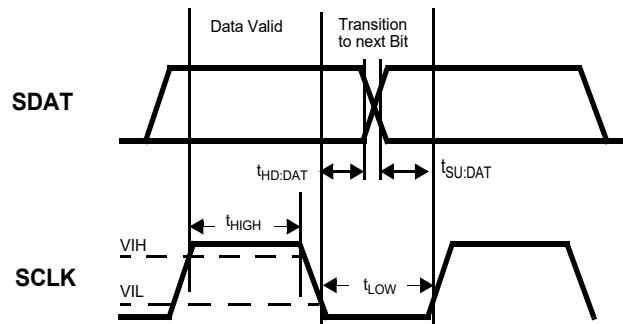

Data Frame

Every new data frame is indicated by a start and stop sequence, as illustrated in [Figure 5](#).

START Sequence - Start frame is indicated by SDA going LOW when SCLK is HIGH. Every time a start signal is given, the next 8-bit data must be the device address (seven bits) and a R/W bit,

followed by the register address (eight bits) and register data (eight bits).

STOP Sequence - Stop frame is indicated by SDA going HIGH when SCLK is HIGH. A stop frame frees the bus for writing to another part on the same bus or writing to another random register address.

Figure 5. Start and Stop Frame

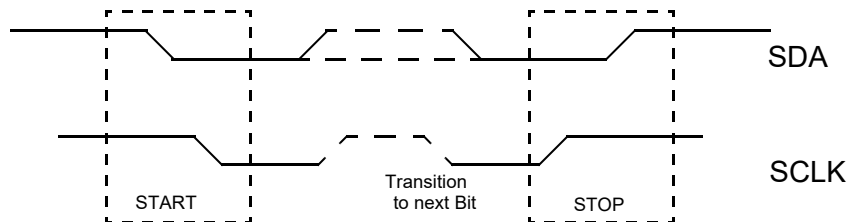

Note

- Field-programmable devices are shipped unprogrammed and must be programmed before being installed on a PCB. An unprogrammed device will output the crystal frequency of the integrated crystal (25 MHz for commercial and 38.8 MHz for industrial).

Acknowledge Pulse

During write mode, the CY2X014/CY2X0147 device responds with an Acknowledge (ACK) pulse after every eight bits. This is accomplished by pulling the SDA line LOW during the N*9th clock

cycle as illustrated in Figure 6 (N = the number of bytes transmitted). After the data packet is sent during read mode, the master generates the acknowledge.

Figure 6. Frame Format (Device Address, R/W, Register Address, Register Data)

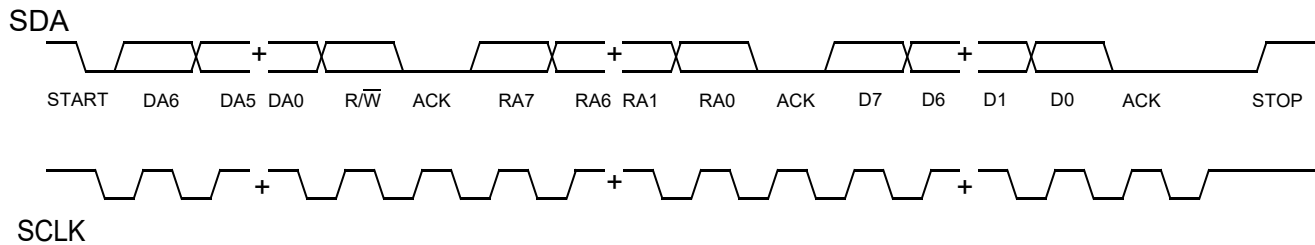

Write Operations

Writing Individual Bytes

A valid write operation must have a full 8-bit register address after the device address word from the master, which is followed by an ACK bit from the slave (SDA = 0/LOW). The next eight bits must contain the data word intended for storage. After the data word is received, the slave responds with another ACK bit (SDA = 0/LOW), and the master must end the write sequence with a STOP condition.

Writing Multiple Bytes

To write more than one byte at a time, the master does not end the write sequence with a stop condition. Instead, the master can send multiple contiguous bytes of data to be stored. After each byte, the slave responds with an acknowledge bit, just like after the first byte, and accepts data until the ACK bit is responded to by the STOP condition. When receiving multiple bytes, the CY2X014/CY2X0147 internally increments the register address.

Read Operations

Read operations are initiated the same way as write operations except that the R/W bit of the slave address is set to '1' (HIGH). There are three basic read operations: current address read, random read, and sequential read.

Current Address Read

The CY2X014/CY2X0147 has an onboard address counter that retains 1 more than the address of the last word access. If the last word written or read was word 'n', then a current address read operation would return the value stored in location 'n+1'. When the CY2X0147 receives the slave address with the R/W

bit set to a '1', the CY2X014/CY2X0147 device issues an ACK and transmits the 8-bit word. The master device does not acknowledge the transfer, but does generate a STOP condition, which causes the CY2X014/CY2X0147 device to stop transmission.

Random Read

Through random read operations, the master may access any memory location. To perform this type of read operation, first the word address must be set. This is accomplished by sending the address to the CY2X014/CY2X0147 device as part of a write operation. After the word address is sent, the master generates a START condition following the acknowledge. This terminates the write operation before any data is stored in the address, but not before the internal address pointer is set. Next, the master reissues the control byte with the R/W byte set to '1'. The CY2X014/CY2X0147 then issues an acknowledge and transmits the 8-bit word. The master device does not acknowledge the transfer but does generate a STOP condition which causes the CY2X014/CY2X0147 device to stop transmission.

Sequential Read

Sequential read operations follow the same process as random reads except that the master issues an ACK instead of a STOP condition after transmission of the first 8-bit data word. This action results in an incrementing of the internal address pointer and subsequently output of the next 8-bit data word. By continuing to issue acknowledges instead of STOP conditions, the master may serially read the entire contents of the slave device memory. When the internal address pointer points to the FFh register, after the next increment, the pointer will point to the 00h register.

Serial Programming Interface Timing Specifications

Parameter	Description	Min	Max	Unit
f_{SCLK}	Frequency of SCLK	–	100	kHz
$t_{HD:STA}$	Hold time START condition	4.0	–	μ s
t_{LOW}	Low period of the SCLK clock	4.7	–	μ s
t_{HIGH}	High period of the SCLK clock	4.0	–	μ s
$t_{SU:STA}$	Setup time for a repeated START condition	4.7	–	μ s
$t_{HD:DAT}$	Data hold time	200	–	ns
$t_{SU:DAT}$	Data setup time	1000	–	ns
t_R	Rise time	–	300	ns
t_F	Fall time	–	300	ns
$t_{SU:STO}$	Setup time for STOP condition	4.0	–	μ s
t_{BUF}	Bus-free time between STOP and START conditions	4.7	–	μ s

Figure 7. Definition for Timing on the Serial Bus

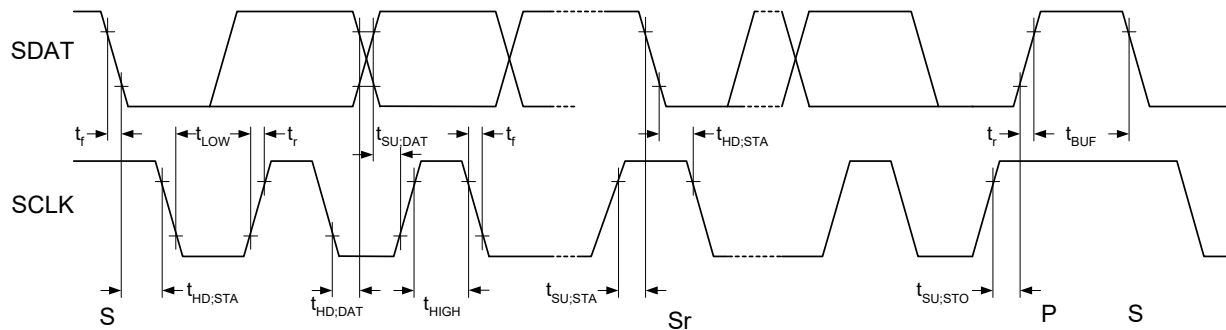

Absolute Maximum Conditions

Parameter	Description	Condition	Min	Max	Unit
V _{DD}	Supply voltage		-0.5	4.4	V
V _{IN} ^[3]	Input voltage, DC	Relative to V _{SS}	-0.5	V _{DD} + 0.5	V
T _S	Temperature, storage	Non operating	-55	135	°C
T _J	Temperature, junction		-40	135	°C
ESD _{HBM}	Electrostatic discharge (ESD) protection human body model (HBM)	JEDEC Std 22-A114-B	2000	-	V
Θ _{JA} ^[4]	Thermal resistance, junction to ambient	0 m/s airflow	64		°C / W

Operating Conditions

Parameter	Description	Min	Typ	Max	Unit
V _{DD}	3.3 V supply voltage range	3.0	3.3	3.6	V
	2.5 V supply voltage range	2.375	2.5	2.625	V
T _{PU}	Power-up time for V _{DD} to reach minimum specified voltage (power ramp is monotonic)	0.05	-	500	ms
T _A	Ambient temperature (commercial)	0	-	70	°C
	Ambient temperature (industrial)	-40	-	85	°C

Notes

- The voltage on any input or I/O pin cannot exceed the power pin during power-up.
- Simulated. The board is derived from the JEDEC multilayer standard. It measures 76 × 114 × 1.6 mm and has 4 layers of copper (2/1/1/2 oz.). The internal layers are 100% copper planes, while the top and bottom layers have 50% metalization. No vias are included in the model.

DC Electrical Characteristics

Parameter	Description	Condition	Min	Typ	Max	Unit
$I_{DD}^{[5]}$	Operating supply current	$V_{DD} = 3.6\text{ V}$, CLK = 150 MHz, output terminated, OE/PD# = V_{DD}	–	–	150	mA
		$V_{DD} = 2.625\text{ V}$, CLK = 150 MHz, output terminated, OE/PD# = V_{DD}	–	–	145	mA
I_{SB}	Standby supply current	PD# = V_{SS}	–	–	200	μA
V_{OH}	LVPECL high output voltage	$V_{DD} = 3.3\text{ V}$ or 2.5 V , $R_{TERM} = 50\ \Omega$ to $V_{DD} - 2.0\text{ V}$	$V_{DD} - 1.15$	–	$V_{DD} - 0.75$	V
V_{OL}	LVPECL low output voltage	$V_{DD} = 3.3\text{ V}$ or 2.5 V , $R_{TERM} = 50\ \Omega$ to $V_{DD} - 2.0\text{ V}$	$V_{DD} - 2.0$	–	$V_{DD} - 1.625$	V
V_{OD1}	LVPECL output voltage swing ($V_{OH} - V_{OL}$)	$V_{DD} = 3.3\text{ V}$ or 2.5 V , $R_{TERM} = 50\ \Omega$ to $V_{DD} - 2.0\text{ V}$	600	–	1000	mV
V_{OD2}	LVPECL output voltage swing ($V_{OH} - V_{OL}$)	$V_{DD} = 2.5\text{ V}$, $R_{TERM} = 50\ \Omega$ to $V_{DD} - 1.5\text{ V}$	500	–	1000	mV
V_{OCM}	LVPECL output common mode voltage ($V_{OH} + V_{OL}$)/2	$V_{DD} = 2.5\text{ V}$, $R_{TERM} = 50\ \Omega$ to $V_{DD} - 1.5\text{ V}$	1.2	–	–	V
I_{OZ}	LVPECL output leakage current	PD#/OE = V_{SS}	–35	–	35	μA
V_{IH}	Input high voltage		$0.7 \times V_{DD}$	–	–	V
V_{IL}	Input low voltage		–	–	$0.3 \times V_{DD}$	V
I_{IH}	Input high current	Input = V_{DD}	–	–	115	μA
I_{IL}	Input low current	Input = V_{SS}	–	–	50	μA
C_{IN}	Input capacitance		–	15	–	pF

Termination Circuits

Figure 8. LVPECL Termination



Note

5. I_{DD} includes ~24 mA of current that is dissipated externally in the output termination resistors.

AC Electrical Characteristics

The following table lists the AC electrical specifications for this device. ^[6]

Parameter	Description	Condition	Min	Typ	Max	Unit
F _{OUT}	Output frequency ^[7]		50	–	690	MHz
FSC	Frequency stability, commercial devices ^[8]	V _{DD} = min to max, T _A = 0 °C to 70 °C	–	–	±35	ppm
FSI	Frequency stability, industrial devices ^[8]	V _{DD} = min to max, T _A = –40 °C to 85 °C	–	–	±55	ppm
AG	Aging, 10 years		–	–	±15	ppm
T _{DC}	Output duty cycle	F ≤ 450 MHz, measured at zero crossing	45	50	55	%
		F > 450 MHz, measured at zero crossing	40	50	60	%
T _R , T _F	Output rise and fall time	20% and 80% of full output swing	0.2	0.4	1.0	ns
T _{OHZ}	Output disable time	Time from falling edge on OE to stopped outputs (asynchronous)	–	–	100	ns
T _{OE}	Output enable time	Time from rising edge on OE to outputs at a valid frequency (asynchronous)	–	–	100	ns
T _{LOCK}	Startup time	Time for CLK to reach valid frequency measured from the time V _{DD} = V _{DD} (min) or from PD# rising edge	–	–	10	ms
T _{LSE} R	Relock time	Time for CLK to reach valid frequency from serial bus change to select bits in register 40h, measured from I ² C STOP (Device Type 2) or Time for CLK to reach valid frequency from FS0 or FS1 pin change (Device Type 3)	–	–	1	ms
T _{Jitter(φ)}	RMS phase jitter (random)	F _{OUT} = 106.25 MHz (12 kHz to 20 MHz)	–	1	–	ps

Notes

6. Not 100% tested, guaranteed by design and characterization.
7. This parameter is specified in the CyClockWizard 1.0 software.
8. Frequency stability is the maximum variation in frequency from F₀. It includes initial accuracy, and variation from temperature and supply voltage.

Switching Waveforms

Figure 9. Output Voltage Swing

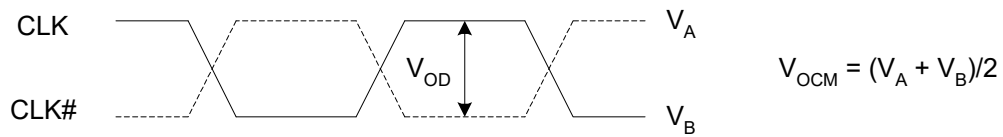

Figure 10. Duty Cycle Timing

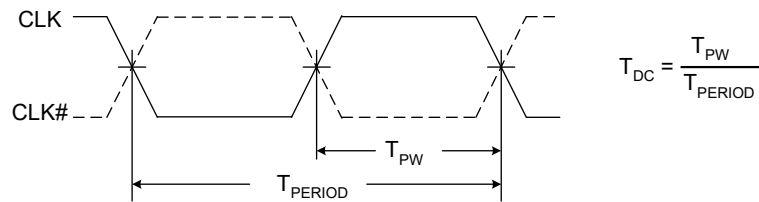

Figure 11. Output Rise and Fall Time

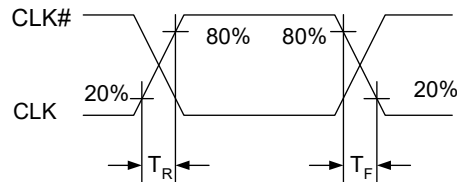
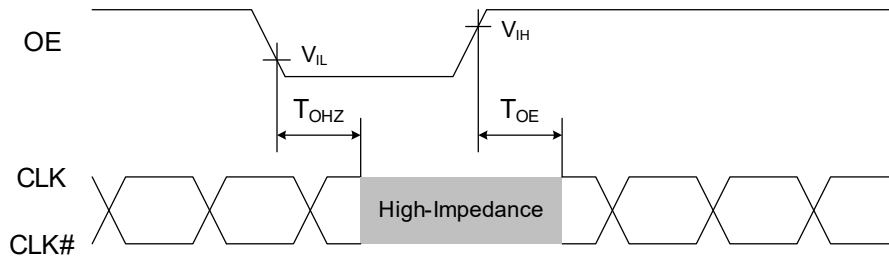

Figure 12. Output Enable and Disable Timing



Typical Output Characteristics

Figure 13. 2.5 V Supply and Termination to $V_{DD}-1.5$ V, Minimum V_{DD} and Maximum T_A

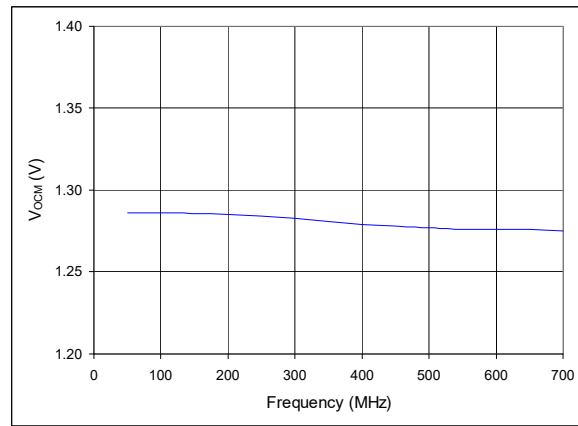
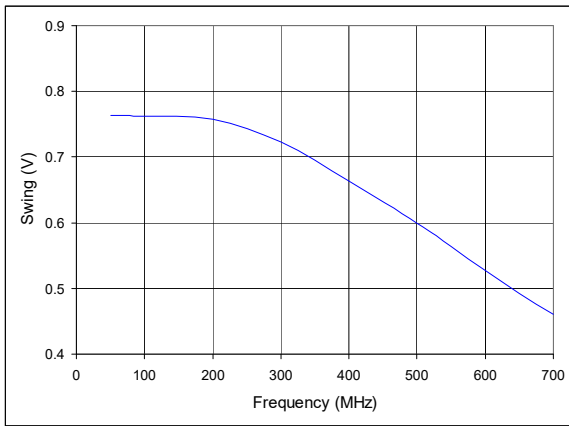

Figure 14. 2.5 V Supply and Termination to $V_{DD}-2$ V, Minimum V_{DD} and Maximum T_A

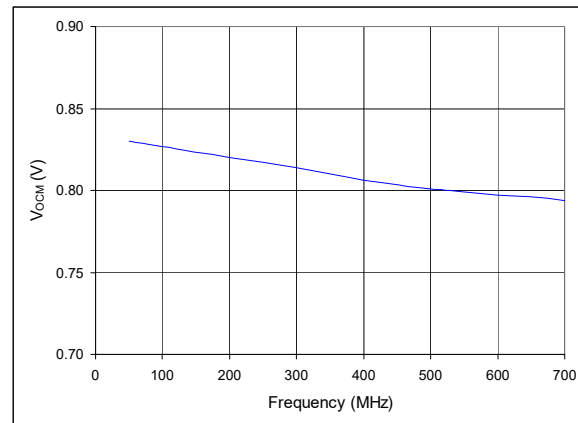
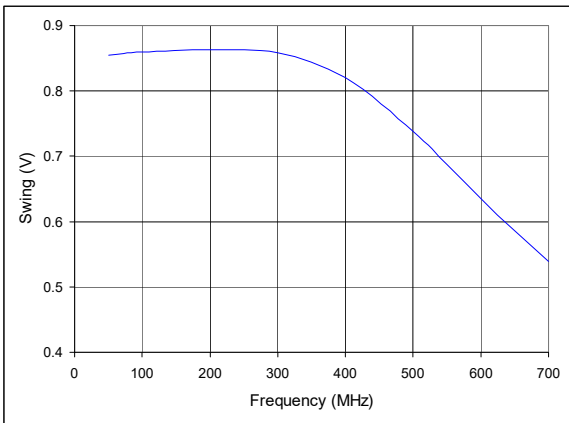
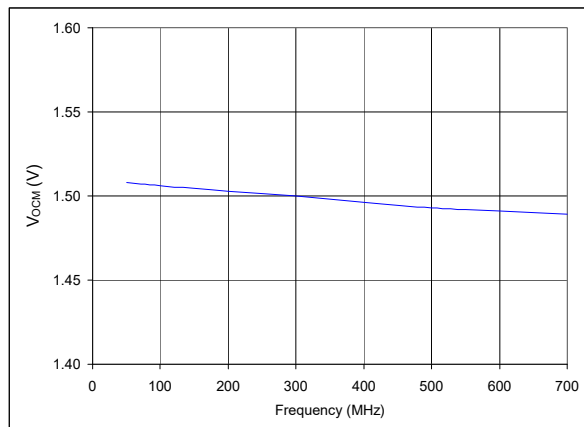
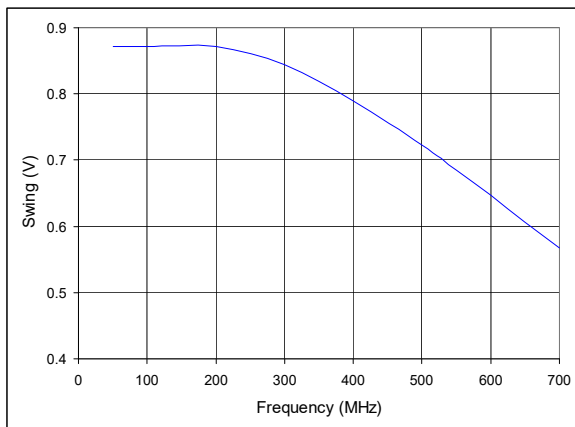

Figure 15. 3.3 V Supply and Termination to $V_{DD}-2$ V, Minimum V_{DD} and Maximum T_A



Ordering Information

Part Number	Configuration	Package Description	Product Flow
Pb-free			
CY2X014FLXIT	Field-programmable	6-pin ceramic LCC SMD - Tape and Reel	Industrial, -40 °C to 85 °C
CY2X0147FLXCT	Field-programmable	6-pin ceramic LCC SMD - Tape and Reel	Commercial, 0 °C to 70 °C
CY2X0147FLXIT	Field-programmable	6-pin ceramic LCC SMD - Tape and Reel	Industrial, -40 °C to 85 °C

Some product offerings are factory-programmed, customer-specific devices with customized part numbers. The [Possible Configurations](#) table shows the available device types, but not complete part numbers. Contact your local Cypress FAE or sales representative for more information.

Possible Configurations

Part Number ^[9]	Configuration	Package Description	Product Flow
Pb-free			
CY2X014LXCxxx	Factory-configured	6-pin ceramic LCC SMD	Commercial, 0 °C to 70 °C
CY2X014LXCxxxT	Factory-configured	6-pin ceramic LCC SMD - Tape and Reel	Commercial, 0 °C to 70 °C
CY2X014LXLxxx	Factory-configured	6-pin ceramic LCC SMD	Industrial, -40 °C to 85 °C
CY2X014LXLxxxT	Factory-configured	6-pin ceramic LCC SMD - Tape and Reel	Industrial, -40 °C to 85 °C
CY2X0147LXCxxx	Factory-configured	6-pin ceramic LCC SMD	Commercial, 0 °C to 70 °C
CY2X0147LXCxxxT	Factory-configured	6-pin ceramic LCC SMD - Tape and Reel	Commercial, 0 °C to 70 °C
CY2X0147LXLxxx	Factory-configured	6-pin ceramic LCC SMD	Industrial, -40 °C to 85 °C
CY2X0147LXLxxxT	Factory-configured	6-pin ceramic LCC SMD - Tape and Reel	Industrial, -40 °C to 85 °C

Ordering Code Definitions

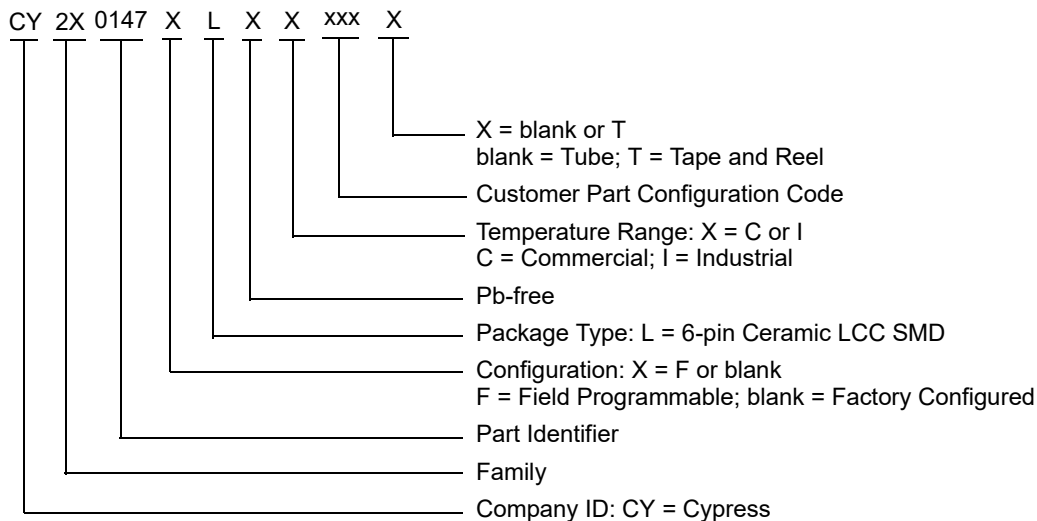

Note

9. "xxx" indicates factory-programmed parts based on customer-specific configurations. For more details, contact your local Cypress FAE or a sales representative.

Package Diagrams

Figure 16. 6-pin Ceramic LCC (5.0 × 3.2 × 1.30 mm) LZ06B Package Outline, 001-10044

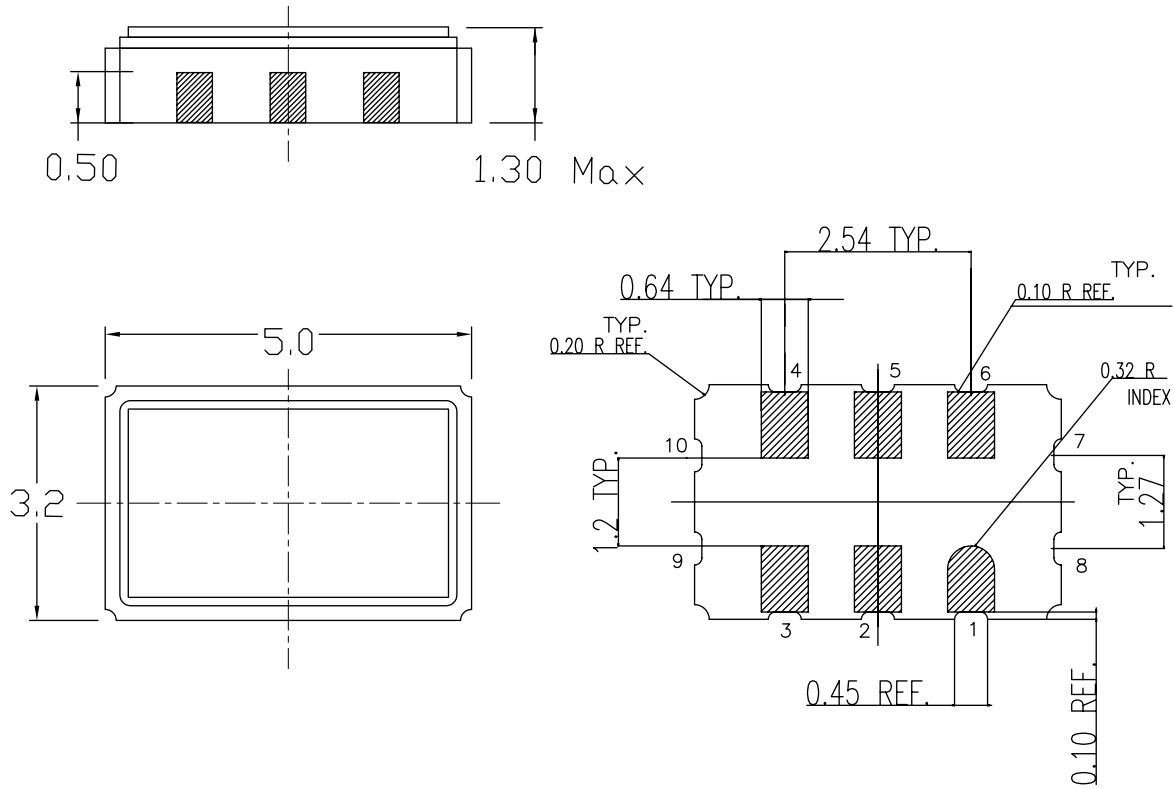

001-10044 *C

Package Diagrams (continued)

Figure 17. 6-pin Ceramic LCC (5.0 × 7.0 × 1.80 mm) LZ06B Package Outline, 001-85862

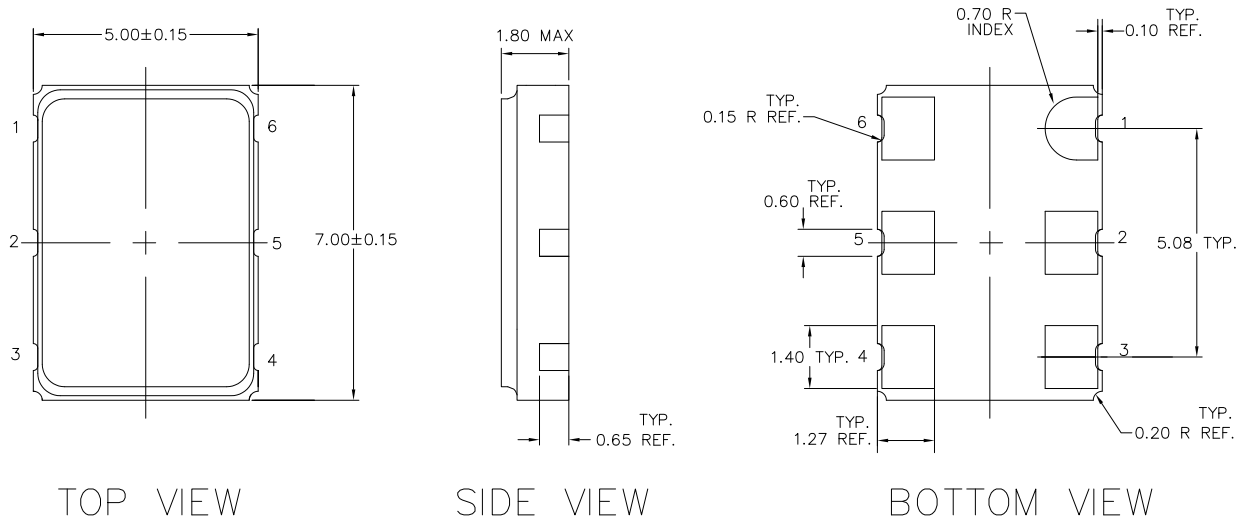

- NOTES:
1. Dimensions are in mm
 2. Kyocera Ref. Drawing No. KD-VA1806

001-85862 *A

Acronyms

Acronym	Description
ESD	Electrostatic discharge
FAE	Field application engineer
HBM	Human Body Model
JEDEC	Joint Electron Devices Engineering Council
LCC	Leadless chip carrier
LVPECL	Low-voltage positive emitter coupled logic
OE	Output Enable
OTP	One-time programmable
PCB	Printed circuit board
PLL	Phase-locked loop
RMS	Root mean square
XO	Crystal oscillator

Document Conventions

Units of Measure

Symbol	Unit of Measure
°C	degree Celsius
MHz	megahertz
μA	microampere
mA	milliampere
mV	millivolt
ms	millisecond
ns	nanosecond
Ω	ohm
ppm	parts per million
pF	picofarad
ps	picosecond
V	volt
W	watt

Document History Page

Document Title: CY2X014/CY2X0147, Low-Jitter LVPECL Crystal Oscillator Document Number: 001-88287				
Rev.	ECN	Orig. of Change	Submission Date	Description of Change
**	3944886	CINM	07/02/2013	New data sheet.
*A	4178261	CINM	10/30/2013	Changed status from Preliminary to Final.
*B	4485619	SAMP	08/27/2014	Replaced LVDS with LVPECL in all instances across the document.
*C	4587303	SAMP	12/05/2014	Updated Functional Description : Added "For a complete list of related documentation, click here ." at the end. Updated Memory Map : Updated Serial Interface Protocol and Timing : Updated Figure 3 (Changed the last ACK in SDA Read from "ACK" to "NACK").
*D	4756544	XHT	05/06/2015	Updated Document Title to read as "CY2X014/CY2X0147, Low-Jitter LVPECL Crystal Oscillator". Added CY2X014 related information in all instances across the document. Updated Read Operations : Removed figure "Data Transfer Sequence on the Serial Bus". Added Serial Programming Interface Timing Specifications . Updated Ordering Information : Updated part numbers. Updated Possible Configurations : Updated part numbers. Updated Ordering Code Definitions . Updated Package Diagrams : Added spec 001-10044 Rev. *C. Completing Sunset Review.
*E	5435358	XHT	09/13/2016	Updated to new template. Completing Sunset Review.
*F	6063701	XHT	02/08/2018	Updated Ordering Information : Updated part numbers. Updated to new template.

Sales, Solutions, and Legal Information

Worldwide Sales and Design Support

Cypress maintains a worldwide network of offices, solution centers, manufacturer's representatives, and distributors. To find the office closest to you, visit us at [Cypress Locations](#).

Products

Arm® Cortex® Microcontrollers	cypress.com/arm
Automotive	cypress.com/automotive
Clocks & Buffers	cypress.com/clocks
Interface	cypress.com/interface
Internet of Things	cypress.com/iot
Memory	cypress.com/memory
Microcontrollers	cypress.com/mcu
PSoC	cypress.com/psoc
Power Management ICs	cypress.com/pmic
Touch Sensing	cypress.com/touch
USB Controllers	cypress.com/usb
Wireless Connectivity	cypress.com/wireless

PSoC® Solutions

[PSoC 1](#) | [PSoC 3](#) | [PSoC 4](#) | [PSoC 5LP](#) | [PSoC 6 MCU](#)

Cypress Developer Community

[Community](#) | [Projects](#) | [Video](#) | [Blogs](#) | [Training](#) | [Components](#)

Technical Support

cypress.com/support

© Cypress Semiconductor Corporation, 2013-2018. This document is the property of Cypress Semiconductor Corporation and its subsidiaries, including Spansion LLC ("Cypress"). This document, including any software or firmware included or referenced in this document ("Software"), is owned by Cypress under the intellectual property laws and treaties of the United States and other countries worldwide. Cypress reserves all rights under such laws and treaties and does not, except as specifically stated in this paragraph, grant any license under its patents, copyrights, trademarks, or other intellectual property rights. If the Software is not accompanied by a license agreement and you do not otherwise have a written agreement with Cypress governing the use of the Software, then Cypress hereby grants you a personal, non-exclusive, nontransferable license (without the right to sublicense) (1) under its copyright rights in the Software (a) for Software provided in source code form, to modify and reproduce the Software solely for use with Cypress hardware products, only internally within your organization, and (b) to distribute the Software in binary code form externally to end users (either directly or indirectly through resellers and distributors), solely for use on Cypress hardware product units, and (2) under those claims of Cypress's patents that are infringed by the Software (as provided by Cypress, unmodified) to make, use, distribute, and import the Software solely for use with Cypress hardware products. Any other use, reproduction, modification, translation, or compilation of the Software is prohibited.

TO THE EXTENT PERMITTED BY APPLICABLE LAW, CYPRESS MAKES NO WARRANTY OF ANY KIND, EXPRESS OR IMPLIED, WITH REGARD TO THIS DOCUMENT OR ANY SOFTWARE OR ACCOMPANYING HARDWARE, INCLUDING, BUT NOT LIMITED TO, THE IMPLIED WARRANTIES OF MERCHANTABILITY AND FITNESS FOR A PARTICULAR PURPOSE. To the extent permitted by applicable law, Cypress reserves the right to make changes to this document without further notice. Cypress does not assume any liability arising out of the application or use of any product or circuit described in this document. Any information provided in this document, including any sample design information or programming code, is provided only for reference purposes. It is the responsibility of the user of this document to properly design, program, and test the functionality and safety of any application made of this information and any resulting product. Cypress products are not designed, intended, or authorized for use as critical components in systems designed or intended for the operation of weapons, weapons systems, nuclear installations, life-support devices or systems, other medical devices or systems (including resuscitation equipment and surgical implants), pollution control or hazardous substances management, or other uses where the failure of the device or system could cause personal injury, death, or property damage ("Unintended Uses"). A critical component is any component of a device or system whose failure to perform can be reasonably expected to cause the failure of the device or system, or to affect its safety or effectiveness. Cypress is not liable, in whole or in part, and you shall and hereby do release Cypress from any claim, damage, or other liability arising from or related to all Unintended Uses of Cypress products. You shall indemnify and hold Cypress harmless from and against all claims, costs, damages, and other liabilities, including claims for personal injury or death, arising from or related to any Unintended Uses of Cypress products.

Cypress, the Cypress logo, Spansion, the Spansion logo, and combinations thereof, WICED, PSoC, CapSense, EZ-USB, F-RAM, and Traveo are trademarks or registered trademarks of Cypress in the United States and other countries. For a more complete list of Cypress trademarks, visit cypress.com. Other names and brands may be claimed as property of their respective owners.