

# K50 Pro Indicator

## Datasheet

50 mm Programmable Multicolor RGB Indicator with Audible Models and an Optional Flashing Input Control

Standard model

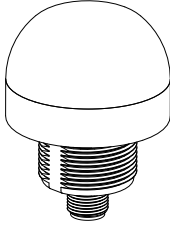

Compact model

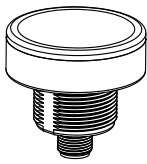

- Bright, uniform indicator light
- Seven default colors in one device (Green, Red, Yellow, Blue, White, Cyan, Magenta)
- Programmable using Banner's Pro Editor software and Pro Converter Cable
- 30 mm threaded polycarbonate base
- Translucent polycarbonate dome
- Compact models available for lower profile applications
- Rugged IP66, IP67, IP69K per DIN 40050-9 and UL Type 4X and UL Type 13 design
- Bimodal inputs (PNP/NPN), depending on source wiring
- Models with integrated audible alarm available
- Variety of connector options
- Models constructed from FDA-grade materials available

## Pro Editor

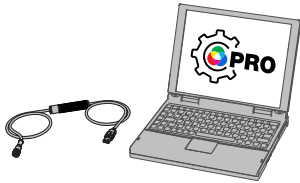

Use Banner's Pro Editor software and Pro Converter Cable to create custom configurations by selecting different colors, flash patterns, and animations. For more information visit [www.bannerengineering.com/proeditor](http://www.bannerengineering.com/proeditor).

## Models

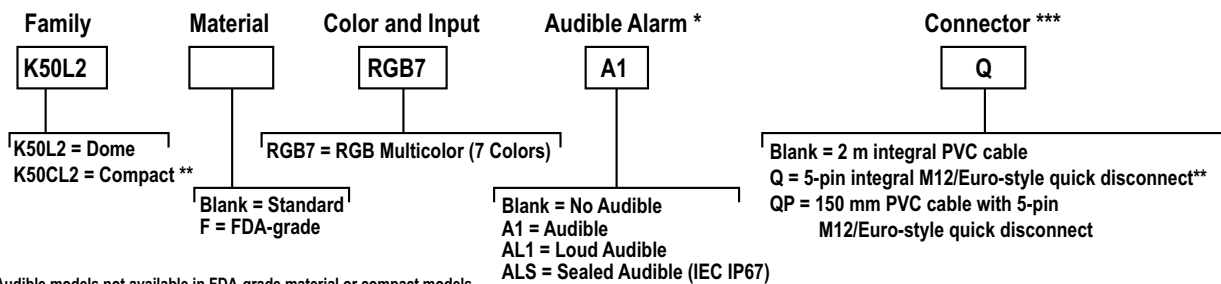

\* Audible models not available in FDA-grade material or compact models

\*\* Compact models and Integral quick disconnect models not available in FDA-grade material

\*\*\* Models with a quick disconnect require a mating cordset

## Wiring Diagrams

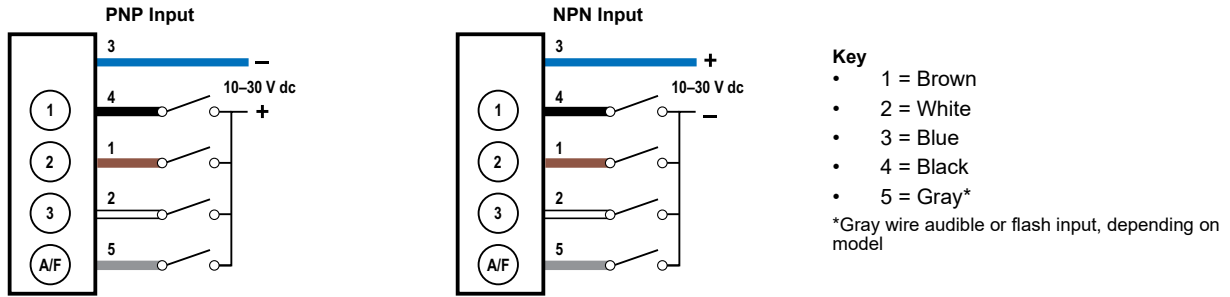

Table 1: Default Color Definition

	Red	Yellow	Green	Cyan	Blue	Magenta	White
Input 1	X	X				X	X
Input 2		X	X	X			X
Input 3				X	X	X	X

An "X" denotes an active input, for example when Input 1 and Input 3 are active, the indicator will show Magenta.

## Specifications

### Supply Voltage and Current

- 10 V DC to 30 V DC
- 220 mA at 10 V DC
- 190 mA at 12 V DC
- 115 mA at 24 V DC
- 100 mA at 30 V DC

### Supply Protection Circuitry

Protected against reverse polarity and transient voltages

### Leakage Current Immunity

400 µA

### Input Response Time

250 milliseconds maximum

### Flash

Default 1.5 Hz flash rate using flash input wire (not available on audible models)

### Audible Alarm

- All models have a steady tone
- A1 Model: 75 dB at 1 meter (typical), 3 kHz ± 500 Hz
- AL1 Model: 95 dB at 1 meter (typical), 2.7 kHz ± 500 Hz
- ALS Model: 94 dB at 1 meter (typical), 2.9 kHz ± 250 Hz

### Connections

Integral 5-pin M12 male quick-disconnect connector, 150 mm (6 in) PVC-jacketed cable with an M12 quick disconnect, or 2 m (6.5 ft) integral PVC-jacketed cable, depending on model  
Models with a quick disconnect require a mating cordset

### Mounting

M30 by 1.5 threaded base, maximum torque 4.5 N·m (40 inch-lbf)  
Mounting nut included

### Construction

Standard and Compact Model Base, Dome, and Nut: Polycarbonate  
FDA Model Base, Dome, and Nut: FDA-grade polycarbonate

### Vibration and Mechanical Shock

Meets IEC 60068-2-6 requirements (Vibration: 10 Hz to 55 Hz, 1.0 mm amplitude, 5 minutes sweep, 30 minutes dwell)  
Meets IEC 60068-2-27 requirements (Shock: 30G 11 ms duration, half sine wave)

### Operating Conditions

-40 °C to +50 °C (-40 °F to +122 °F)  
90% at +50 °C maximum relative humidity (non-condensing)  
Storage Temperature: -40 °C to +70 °C (-40 °F to +158 °F)

### Environmental Rating

Standard and Compact Models:  
Non-Audible Models: IP66, IP67, IP69K per DIN 40050-9  
A1 and AL1 Models: IP50  
ALS Models: IP67  
All Models: Meets UL Type 4X and UL Type 13 when mounted in a UL Type 4X or Type 13 enclosure  
All Cabled Models also meet IP69K per DIN 40050-9 if the cable and cable entrance are protected from high-pressure spray  
FDA Models: IP66, IP67, IP69K per DIN 40050-9

### Pro Editor Configuration

- Connection to Pro Editor software enables control of:
- Animation: On, Flash, Two Color Flash, 50/50, 50/50 Rotate, Chase, Intensity Sweep, Color Sweep, Sequence, Wave, Double Wave,
  - Color: Green, Red, Yellow, Blue, White, Cyan, Magenta, Amber, Rose, Lime Green, Orange, Sky Blue, Violet, Spring Green
  - Intensity: Low, Medium, High
  - Speed: Slow, Standard, Fast

Pro Converter Cable required to interface between PC and indicator, see accessories

**Default Indicator Characteristics**

Color	Dominant Wavelength (nm) or Color Temperature (CCT)	Color Coordinates <sup>a</sup>		Lumen Output (Typical at 25 °C)
		x	y	
Green	530 nm	0.170	0.711	21.4
Red	625 nm	0.688	0.310	6.3
Yellow	–	0.457	0.485	17.2
Blue	470 nm	0.133	0.072	4.7
White	5950 K	0.323	0.336	21.3
Cyan	–	0.154	0.321	25.1
Magenta	–	0.365	0.176	8.5

- a. Refer to CIE 1931 chromaticity diagram or color chart, to show equivalent color with indicated color coordinates.
- b. Values shown apply to dome models only. Compact models are 20% lower.

**Required Overcurrent Protection**

**WARNING:** Electrical connections must be made by qualified personnel in accordance with local and national electrical codes and regulations.

Overcurrent protection is required to be provided by end product application per the supplied table.  
 Overcurrent protection may be provided with external fusing or via Current Limiting, Class 2 Power Supply.  
 Supply wiring leads < 24 AWG shall not be spliced.  
 For additional product support, go to [www.bannerengineering.com](http://www.bannerengineering.com).

Supply Wiring (AWG)	Required Overcurrent Protection (A)	Supply Wiring (AWG)	Required Overcurrent Protection (A)
20	5.0	26	1.0
22	3.0	28	0.8
24	1.0	30	0.5

**Certifications**



**Banner Engineering BV** Park Lane, Culliganlaan  
 2F bus 3, 1831 Diegem, BELGIUM



**Turck Banner LTD** Blenheim House, Blenheim  
 Court, Wickford, Essex SS11 8YT, Great Britain



**FCC Part 15 Class B**

This equipment has been tested and found to comply with the limits for a Class B digital device, pursuant to part 15 of the FCC Rules. These limits are designed to provide reasonable protection against harmful interference in a residential installation. This equipment generates, uses and can radiate radio frequency energy and, if not installed and used in accordance with the instructions, may cause harmful interference to radio communications. However, there is no guarantee that interference will not occur in a particular installation. If this equipment does cause harmful interference to radio or television reception, which can be determined by turning the equipment off and on, the user is encouraged to try to correct the interference by one or more of the following measures:

- Reorient or relocate the receiving antenna.
- Increase the separation between the equipment and receiver.
- Connect the equipment into an outlet on a circuit different from that to which the receiver is connected.
- Consult the dealer or an experienced radio/TV technician for help.

**Industry Canada**

This device complies with CAN ICES-3 (B)/NMB-3(B). Operation is subject to the following two conditions: 1) This device may not cause harmful interference; and 2) This device must accept any interference received, including interference that may cause undesired operation.

Cet appareil est conforme à la norme NMB-3(B). Le fonctionnement est soumis aux deux conditions suivantes : (1) ce dispositif ne peut pas occasionner d'interférences, et (2) il doit tolérer toute interférence, y compris celles susceptibles de provoquer un fonctionnement non souhaité du dispositif.

## Dimensions

All measurements are listed in millimeters [inches], unless noted otherwise.

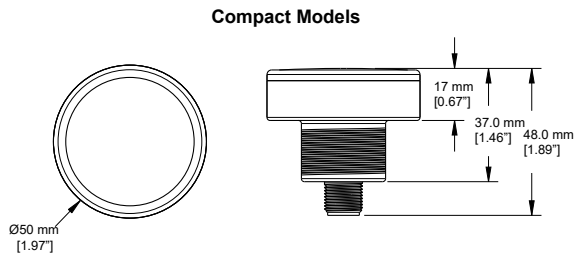
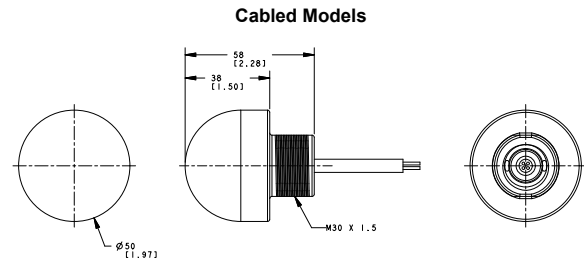
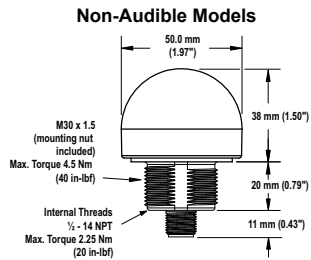
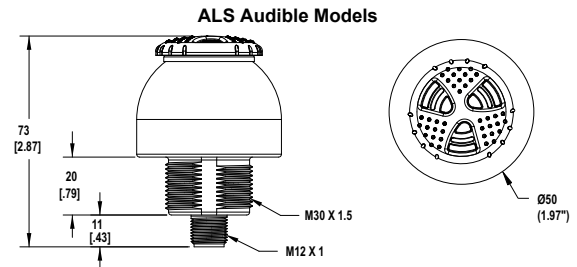
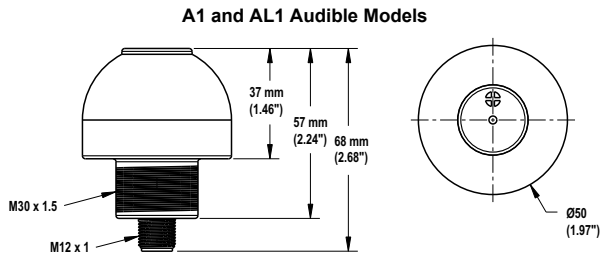

## Accessories

### Pro Editor Hardware

**MQDC-506-USB**

- Pro Converter Cable
- 1.83 m (6 ft) length 5-pin M12 quick disconnect to Device and USB to PC
- Required for connection to Pro Editor

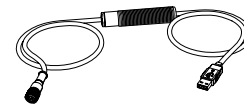

**CSB-M1251FM1251M**

- 5-pin parallel Y splitter (Male-Male-Female)
- For full Pro Editor preview capability
- Requires external power supply, sold separately

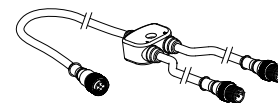

**PSW-24-1**

- 24 V DC, 1 A power supply
- 2 m (6.5 ft) PVC cable with M12 quick disconnect
- Provides external power with splitter cable, sold separately



**ACC-PRO-CABLE5**

- Mating accessory for cabled and terminal models
- 150 mm (6 inch) PVC cable with M12 quick disconnect
- Lever wire nuts included (qty 5)
- Required to connect cabled models and screw terminal models to Pro Converter Cable, sold separately

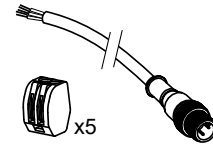

**Cordsets**

**5-Pin Threaded M12 Cordsets—Single Ended**

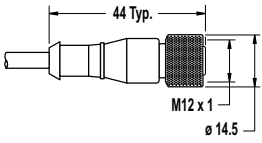
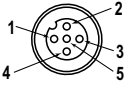
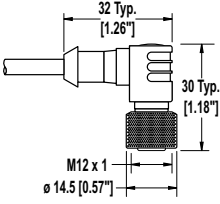
Model	Length	Style	Dimensions	Pinout (Female)
MQDC1-501.5	0.5 m (1.5 ft)	Straight		 <ul style="list-style-type: none"> <li>• 1 = Brown</li> <li>• 2 = White</li> <li>• 3 = Blue</li> <li>• 4 = Black</li> <li>• 5 = Gray</li> </ul>
MQDC1-503	0.9 m (2.9 ft)			
MQDC1-506	2 m (6.5 ft)			
MQDC1-515	5 m (16.4 ft)			
MQDC1-530	9 m (29.5 ft)			
MQDC1-560	18 m (59 ft)			
MQDC1-506RA	2 m (6.5 ft)	Right-Angle		<ul style="list-style-type: none"> <li>• 1 = Brown</li> <li>• 2 = White</li> <li>• 3 = Blue</li> <li>• 4 = Black</li> <li>• 5 = Gray</li> </ul>
MQDC1-515RA	5 m (16.4 ft)			
MQDC1-530RA	9 m (29.5 ft)			
MQDC1-560RA	19 m (62.3 ft)			

**5-Pin Threaded M12 Stainless Steel Washdown Cordsets—Single Ended**

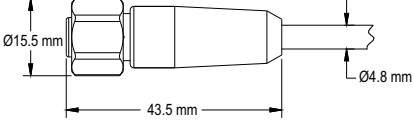
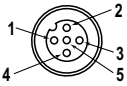
Model	Length	Style	Dimensions	Pinout (Female)
MQDC-WDSS-0506	2 m (6.56 ft)	Straight		 <ul style="list-style-type: none"> <li>• 1 = Brown</li> <li>• 2 = White</li> <li>• 3 = Blue</li> <li>• 4 = Black</li> <li>• 5 = Gray</li> </ul>
MQDC-WDSS-0515	5 m (16.4 ft)			
MQDC-WDSS-0530	9 m (29.5 ft)			

### Splitter Cables for Use with IO-Blocks

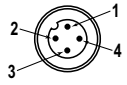
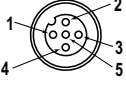
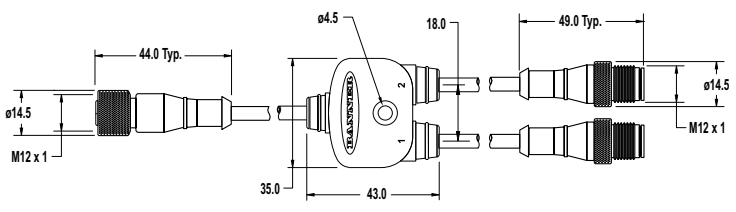
5-Pin Threaded M12 to 4-Pin Threaded M12 Combiner Cordset with Flat Junction			
Model	Branches (Male)	Trunk (Female)	Pinout Key
CSF-M12F51M12M41	4-pin Quick Disconnect, 2 × 0.31 m (1.02 ft)	5-pin Quick Disconnect, 0.31 m (1.02 ft)	<p><b>Trunk</b></p> <ul style="list-style-type: none"> <li>1 = Brown</li> <li>2 = White</li> <li>3 = Blue</li> <li>4 = Black</li> <li>5 = Gray</li> </ul>
			<p><b>Branch 1</b></p> <ul style="list-style-type: none"> <li>1 = NC</li> <li>2 = Brown</li> <li>3 = Blue</li> <li>4 = Black</li> </ul> <p><b>Branch 2</b></p> <ul style="list-style-type: none"> <li>1 = NC</li> <li>2 = Gray</li> <li>3 = Blue</li> <li>4 = White</li> </ul>
			

### Brackets

**SMB30A**

- Right-angle bracket with curved slot for versatile orientation
- Clearance for M6 (¼ in) hardware
- Mounting hole for 30 mm sensor
- 12-ga. stainless steel

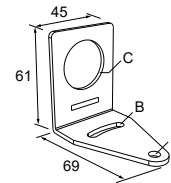

**Hole center spacing:** A to B=40 **Hole size:** A=∅ 6.3, B= 27.1 x 6.3, C=∅ 30.5

**SMB30FVK**

- V-clamp, flat bracket and fasteners for mounting to pipe or extensions
- Clamp accommodates 28 mm dia. tubing or 1 in. square extrusions
- 30 mm hole for mounting sensors

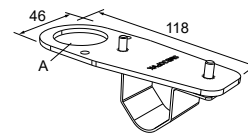

**Hole size:** A= ∅ 31

**SMB30RAVK**

- V-clamp, right-angle bracket and fasteners for mounting sensors to pipe or extrusion
- Clamp accommodates 28 mm dia. tubing or 1 in. square extrusions
- 30 mm hole for mounting sensors

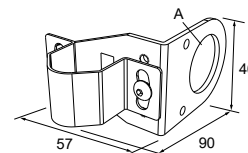

**Hole size:** A = ∅ 30.5

**SMBAMS30P**

- Flat SMBAMS series bracket
- 30 mm hole for mounting sensors
- Articulation slots for 90°+ rotation
- 12-ga. 300 series stainless steel

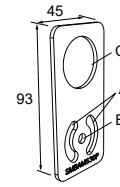

**Hole center spacing:** A=26.0, A to B=13.0 **Hole size:** A=26.8 x 7.0, B=∅ 6.5, C=∅ 31.0

**SMBAMS30RA**

- Right-angle SMBAMS series bracket
- 30 mm hole for mounting sensors
- Articulation slots for 90°+ rotation
- 12-ga. (2.6 mm) cold-rolled steel

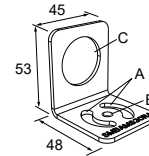

**Hole center spacing:** A=26.0, A to B=13.0 **Hole size:** A=26.8 x 7.0, B=∅ 6.5, C=∅ 31.0

**SMB30MM**

- 12-ga. stainless steel bracket with curved mounting slots for versatile orientation
- Clearance for M6 (¼ in) hardware
- Mounting hole for 30 mm sensor

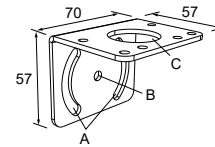

**Hole center spacing:** A = 51, A to B = 25.4 **Hole size:** A = 42.6 x 7, B = ∅ 6.4, C = ∅ 30.1

**SMB30SC**

- Swivel bracket with 30 mm mounting hole for sensor
- Black reinforced thermoplastic polyester
- Stainless steel mounting and swivel locking hardware included

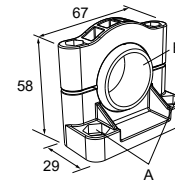

**Hole center spacing:** A=∅ 50.8 **Hole size:** A=∅ 7.0, B=∅ 30.0

**SMB30FA**

- Swivel bracket with tilt and pan movement for precise adjustment
- Mounting hole for 30 mm sensor
- 12-ga. 304 stainless steel
- Easy sensor mounting to extrude rail T-slot
- Metric and inch size bolt available

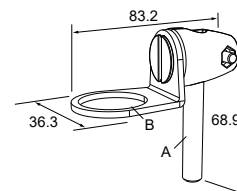

**Bolt thread:** SMB30FA, A= 3/8 - 16 x 2 in; SMB30FAM10, A= M10 - 1.5 x 50 **Hole size:** B= ∅ 30.1

**LMBE12RA35**

- Direct mounting of stand-off pipe, with common bracket type
- Zinc-plated steel
- 1/2-14 NPSM nut
- Mounting distance from the wall to the center of the 1/2-14 NPSM nut is 35 mm

Hole center spacing: 20.0

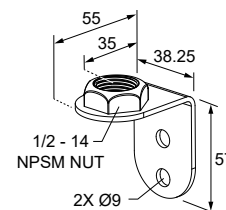

**LMBE12RA45**

- Direct mounting of stand-off pipe, with common bracket type
- Zinc-plated steel
- 1/2-14 NPSM nut
- Mounting distance from the wall to the center of the 1/2-14 NPSM nut is 45 mm

Hole center spacing: 35.0

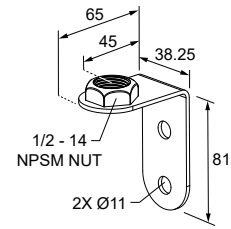

All measurements are listed in millimeters [inches], unless noted otherwise.

## Banner Engineering Corp. Limited Warranty

Banner Engineering Corp. warrants its products to be free from defects in material and workmanship for one year following the date of shipment. Banner Engineering Corp. will repair or replace, free of charge, any product of its manufacture which, at the time it is returned to the factory, is found to have been defective during the warranty period. This warranty does not cover damage or liability for misuse, abuse, or the improper application or installation of the Banner product.

**THIS LIMITED WARRANTY IS EXCLUSIVE AND IN LIEU OF ALL OTHER WARRANTIES WHETHER EXPRESS OR IMPLIED (INCLUDING, WITHOUT LIMITATION, ANY WARRANTY OF MERCHANTABILITY OR FITNESS FOR A PARTICULAR PURPOSE), AND WHETHER ARISING UNDER COURSE OF PERFORMANCE, COURSE OF DEALING OR TRADE USAGE.**

This Warranty is exclusive and limited to repair or, at the discretion of Banner Engineering Corp., replacement. **IN NO EVENT SHALL BANNER ENGINEERING CORP. BE LIABLE TO BUYER OR ANY OTHER PERSON OR ENTITY FOR ANY EXTRA COSTS, EXPENSES, LOSSES, LOSS OF PROFITS, OR ANY INCIDENTAL, CONSEQUENTIAL OR SPECIAL DAMAGES RESULTING FROM ANY PRODUCT DEFECT OR FROM THE USE OR INABILITY TO USE THE PRODUCT, WHETHER ARISING IN CONTRACT OR WARRANTY, STATUTE, TORT, STRICT LIABILITY, NEGLIGENCE, OR OTHERWISE.**

Banner Engineering Corp. reserves the right to change, modify or improve the design of the product without assuming any obligations or liabilities relating to any product previously manufactured by Banner Engineering Corp. Any misuse, abuse, or improper application or installation of this product or use of the product for personal protection applications when the product is identified as not intended for such purposes will void the product warranty. Any modifications to this product without prior express approval by Banner Engineering Corp will void the product warranties. All specifications published in this document are subject to change; Banner reserves the right to modify product specifications or update documentation at any time. Specifications and product information in English supersede that which is provided in any other language. For the most recent version of any documentation, refer to: [www.bannerengineering.com](http://www.bannerengineering.com).

For patent information, see [www.bannerengineering.com/patents](http://www.bannerengineering.com/patents).

Document title: K50 Pro Indicator

Part number: 197815

Revision: I

Original Instructions

© Banner Engineering Corp. All rights reserved.



197815