

FEATURES

Conversion loss (downconverter): 11 dB typical
LO to RF isolation: 36.5 dB typical for 24 GHz to 30 GHz
performance

Input IP3 (downconverter): 20 dBm typical
12-terminal, RoHS compliant, 3 mm × 3 mm LCC package

APPLICATIONS

Microwave and very small aperture terminal (VSAT) radios
Test equipment
Military electronic warfare (EW)
Electronic countermeasure (ECM)
Command, control, communications, and intelligence (C3I)

GENERAL DESCRIPTION

The HMC329ALC3B is a general-purpose, double balanced mixer in a leadless, RoHS compliant, surface-mount technology (SMT) package that can be used as an upconverter or down-converter between 24 GHz and 32 GHz. This mixer is fabricated in a gallium arsenide (GaAs), monolithic microwave integrated circuit (MMIC) process and requires no external components or matching circuitry. The HMC329ALC3B provides excellent local oscillator (LO) to radio frequency (RF) and LO to intermediate

FUNCTIONAL BLOCK DIAGRAM

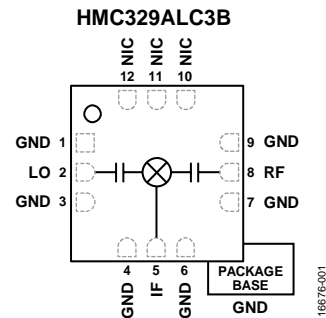

Figure 1.

frequency (IF) suppression due to optimized balun preliminary structures. The mixer operates with LO amplitude above 9 dBm. The RoHS compliant HMC329ALC3B eliminates the need for wire bonding, allowing the use of surface-mount manufacturing techniques.

TABLE OF CONTENTS

Features	1	Downconverter Performance, IF = 1000 MHz.....	6
Applications.....	1	Downconverter Performance, IF = 8000 MHz.....	10
Functional Block Diagram	1	Upconverter Performance, IF = 1000 MHz.....	12
General Description	1	Upconverter Performance, IF = 8000 MHz.....	14
Revision History	2	IF Bandwidth—Downconverter.....	18
Specifications.....	3	Spurious and Harmonics Performance	20
Absolute Maximum Ratings.....	4	Theory of Operation	21
Thermal Resistance	4	Applications Information	22
ESD Caution.....	4	Typical Application Circuit.....	22
Pin Configuration and Function Descriptions.....	5	Evaluation PCB Information	22
Interface Schematics.....	5	Outline Dimensions	23
Typical Performance Characteristics	6	Ordering Guide	23

REVISION HISTORY

5/2018—Revision 0: Initial Version

SPECIFICATIONS

$T_A = 25^\circ\text{C}$, $IF = 1000\text{ MHz}$, $LO = 13\text{ dBm}$ for the upper sideband, unless otherwise noted. All measurements performed as a downconverter, unless otherwise noted, on the evaluation printed circuit board (PCB).

Table 1.

Parameter	Symbol	Min	Typ	Max	Unit
FREQUENCY RANGE					
RF Pin		24		32	GHz
IF Pin		DC		8	GHz
LO Pin		24		32	GHz
LO AMPLITUDE					
24 GHz to 32 GHz Performance		9	13	15	dBm
Downconverter					
Conversion Loss			11	13.5	dB
Single Sideband Noise Figure	SSB NF		12		dB
Input Third-Order Intercept	IP3	15.5	20		dBm
Input 1 dB Compression Point	P1dB		12		dBm
Input Second-Order Intercept	IP2		42		dBm
Upconverter	IF_{IN}				
Conversion Loss			10.5		dB
Input Third-Order Intercept	IP3		15.3		dBm
Input 1 dB Compression Point	P1dB		4.5		dBm
ISOLATION					
24 GHz to 30 GHz Performance					
LO to IF		28	35.5		dB
RF to IF		20	31.5		dB
LO to RF		32	36.5		dB
30 GHz to 32 GHz Performance					
LO to IF		22	30		dB
RF to IF		10.5	24.4		dB
LO to RF		22.5	30.5		dB

ABSOLUTE MAXIMUM RATINGS

Table 2.

Parameter	Rating
RF Input Power	13 dBm
LO Input Power	24 dBm
IF Input Power	13 dBm
IF Source or Sink Current	3 mA
Peak Reflow Temperature	260°C
Maximum Junction Temperature	175°C
Continuous Power Dissipation, P_{DISS} ($T_A = 85^\circ\text{C}$, Derate 3.7 mW/°C Above 85°C)	200 mW
Operating Temperature Range	-55°C to +85°C
Storage Temperature Range	-65°C to +150°C
Lead Temperature (Soldering 60 sec)	260°C
Electrostatic Discharge (ESD) Sensitivity	
Human Body Model (HBM)	1500 V, Class 1C
Field-Induced Charged Device Model (FICDM)	1250 V, Class IV

Stresses at or above those listed under Absolute Maximum Ratings may cause permanent damage to the product. This is a stress rating only; functional operation of the product at these or any other conditions above those indicated in the operational section of this specification is not implied. Operation beyond the maximum operating conditions for extended periods may affect product reliability.

THERMAL RESISTANCE

Thermal performance is directly linked to printed circuit board (PCB) design and operating environment. Careful attention to PCB thermal design is required.

θ_{JA} is the natural convection, junction to ambient thermal resistance measured in a one cubic foot sealed enclosure.

θ_{JC} is the junction to case thermal resistance.

Table 3. Thermal Resistance

Package Type	θ_{JA}	θ_{JC}	Unit
E-12-4 ¹	120	445	°C/W

¹ Test Condition 1: JEDEC standard JESD51-2.

ESD CAUTION



ESD (electrostatic discharge) sensitive device. Charged devices and circuit boards can discharge without detection. Although this product features patented or proprietary protection circuitry, damage may occur on devices subjected to high energy ESD. Therefore, proper ESD precautions should be taken to avoid performance degradation or loss of functionality.

PIN CONFIGURATION AND FUNCTION DESCRIPTIONS

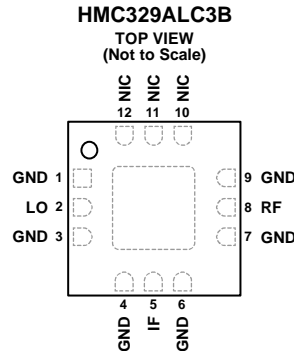

- NOTES**
1. NOT INTERNALLY CONNECTED. THESE PINS CAN BE CONNECTED TO RF/DC GROUND. PERFORMANCE IS NOT AFFECTED.
 2. EXPOSED PAD. THE EXPOSED PAD MUST BE CONNECTED TO RF/DC GROUND.

16676-002

Figure 2. Pin Configuration

Table 4. Pin Function Descriptions

Pin No.	Mnemonic	Description
1, 3, 4, 6, 7, 9	GND	Ground. These pins must be connected to RF/dc ground. See Figure 3 for the interface schematic.
2	LO	LO Port. This pin is ac-coupled and matched to 50 Ω. See Figure 4 for the interface schematic.
5	IF	IF Port. This pin is dc-coupled. For applications not requiring operation to dc, dc block this port externally using a series capacitor of a value chosen to pass the necessary IF frequency range. For operation to dc, this pin must not source or sink more than 3 mA of current. Otherwise, die malfunction or die failure may result. See Figure 5 for the interface schematic.
8	RF	RF Port. This pin is ac-coupled and matched to 50 Ω. See Figure 6 for the interface schematic.
10, 11, 12	NIC EPAD	Not Internally Connected. Connect these pins to RF/dc ground. Performance is not affected. Exposed Pad. The exposed pad must be connected to RF/dc ground.

INTERFACE SCHEMATICS



Figure 3. GND Interface Schematic

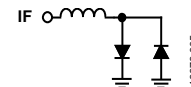

Figure 5. IF Interface Schematic

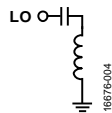

Figure 4. LO Interface Schematic

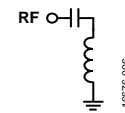

Figure 6. RF Interface Schematic

TYPICAL PERFORMANCE CHARACTERISTICS

DOWNCONVERTER PERFORMANCE, IF = 1000 MHz

Upper Sideband (Low-Side LO)

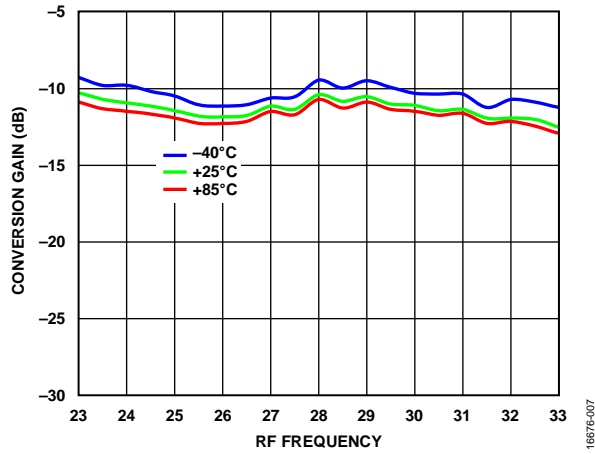

Figure 7. Conversion Gain vs. RF Frequency at Various Temperatures, LO = 13 dBm

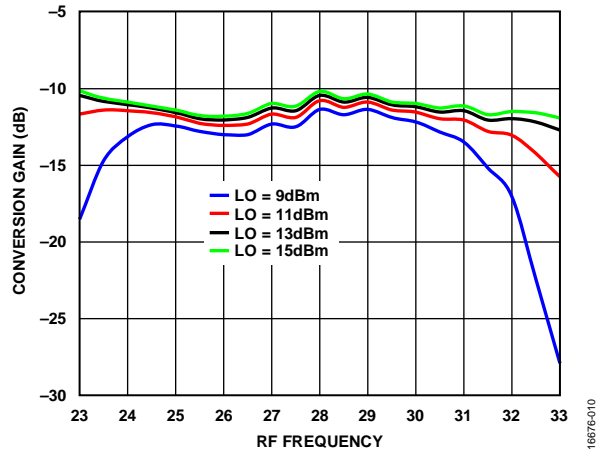

Figure 10. Conversion Gain vs. RF Frequency at Various LO Power Levels, TA = 25°C

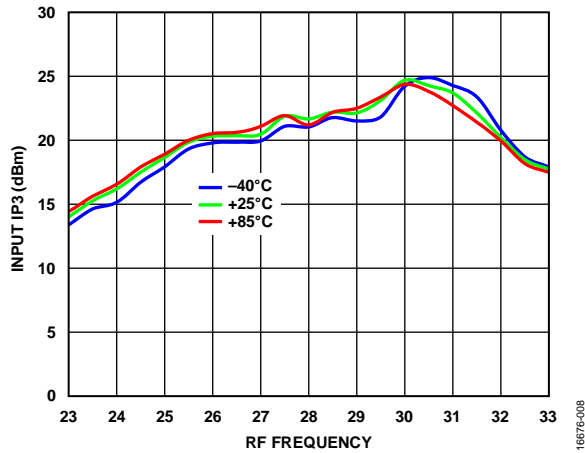

Figure 8. Input IP3 vs. RF Frequency at Various Temperatures, LO = 13 dBm

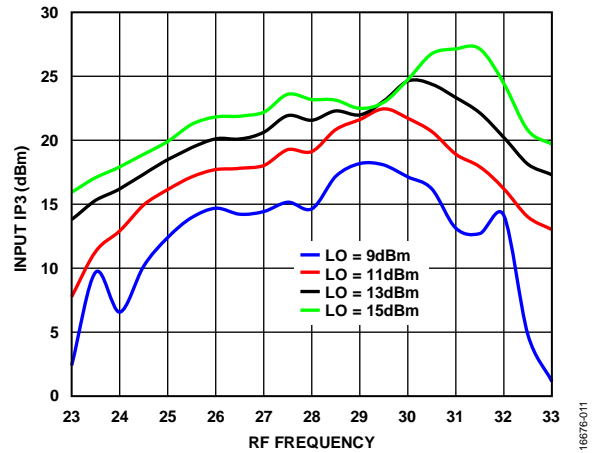

Figure 11. Input IP3 vs. RF Frequency at Various LO Power Levels, TA = 25°C

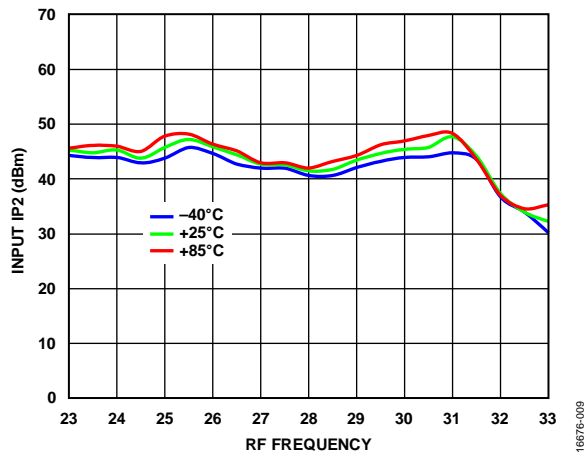

Figure 9. Input IP2 vs. RF Frequency at Various Temperatures, LO = 13 dBm

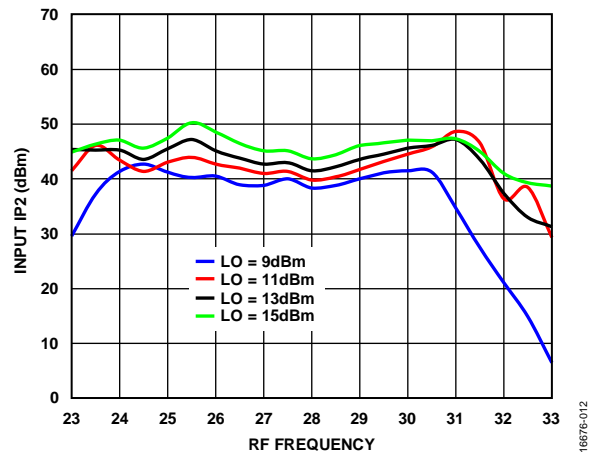

Figure 12. Input IP2 vs. RF Frequency at Various LO Power Levels, TA = 25°C

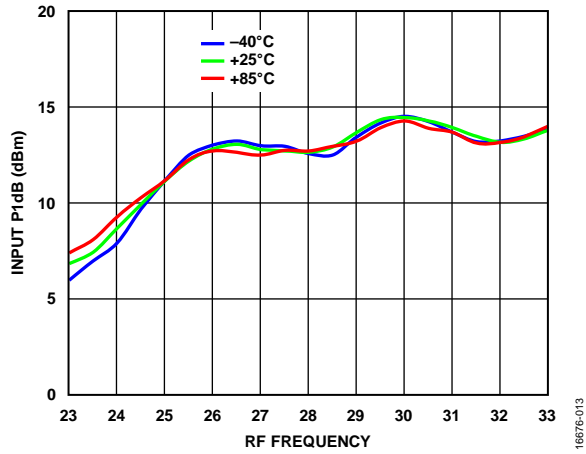

Figure 13. Input P1dB vs. RF Frequency at Various Temperatures, LO = 13 dBm

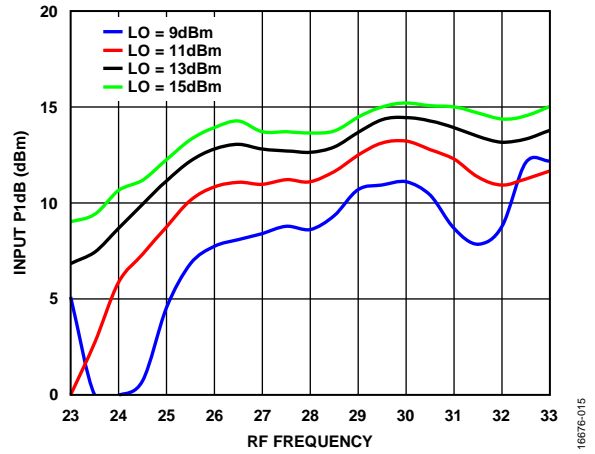

Figure 14. Input P1dB vs. RF Frequency at Various LO Power Levels, TA = 25°C

Lower Sideband (High-Side LO)

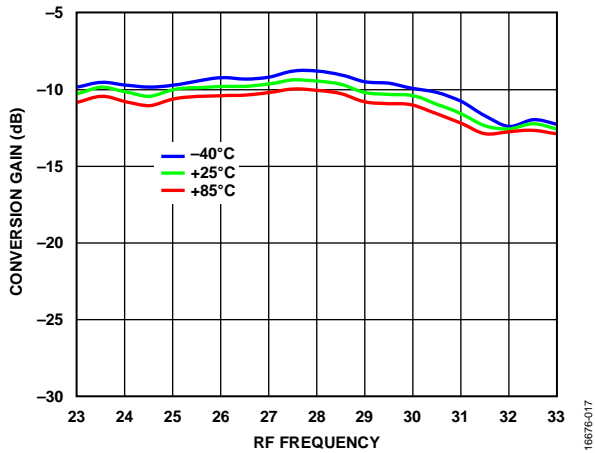

Figure 15. Conversion Gain vs. RF Frequency at Various Temperatures, LO = 13 dBm

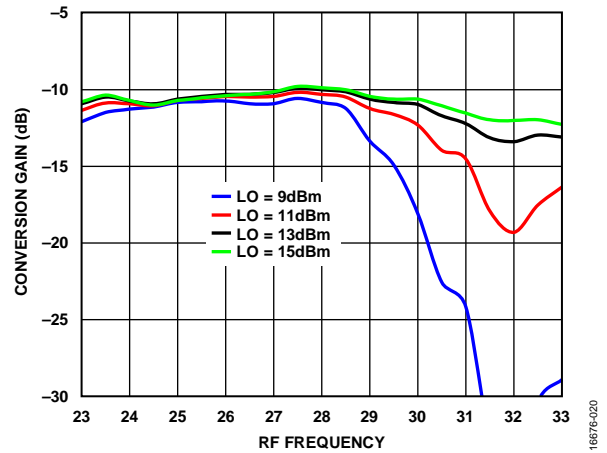

Figure 18. Conversion Gain vs. RF Frequency at Various LO Power Levels, $T_A = 25^\circ\text{C}$

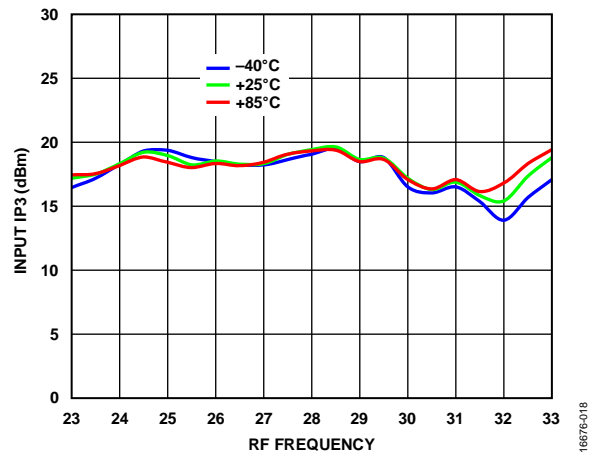

Figure 16. Input IP3 vs. RF Frequency at Various Temperatures, LO = 13 dBm

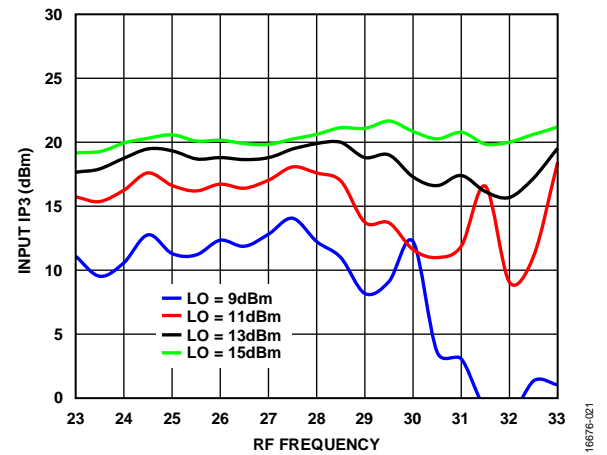

Figure 19. Input IP3 vs. RF Frequency at Various LO Power Levels, $T_A = 25^\circ\text{C}$

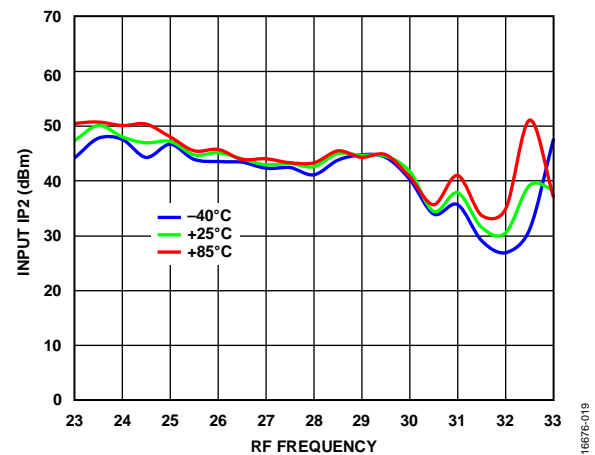

Figure 17. Input IP2 vs. RF Frequency at Various Temperatures, LO = 13 dBm

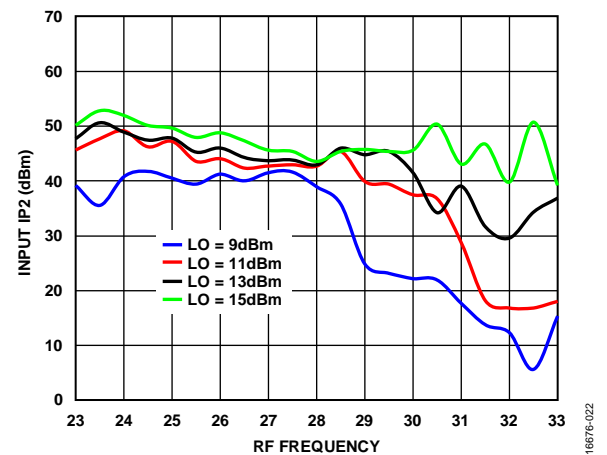

Figure 20. Input IP2 vs. RF Frequency at Various LO Power Levels, $T_A = 25^\circ\text{C}$

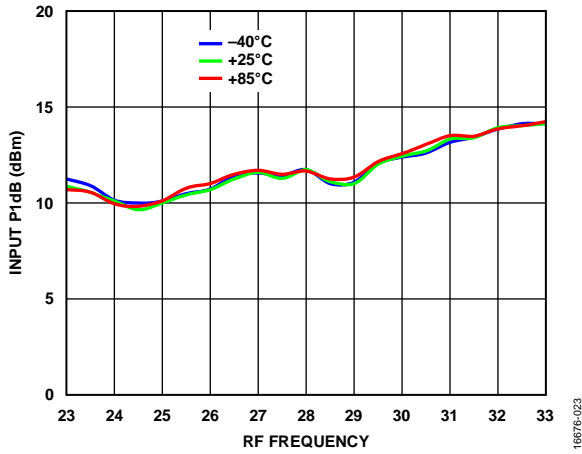

Figure 21. Input P1dB vs. RF Frequency at Various Temperatures, LO = 13 dBm

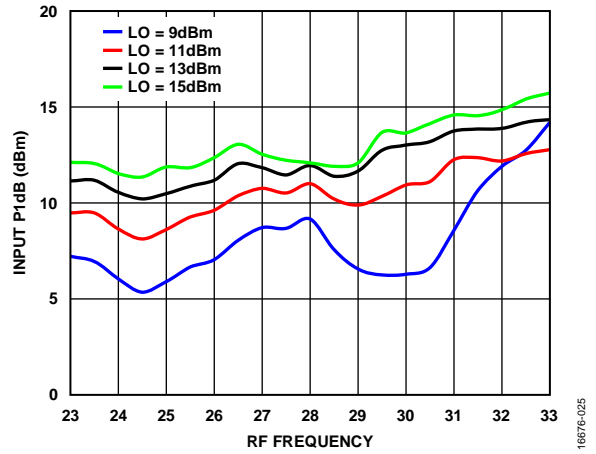

Figure 23. Input P1dB vs. RF Frequency at Various LO Power Levels, $T_A = 25^\circ\text{C}$

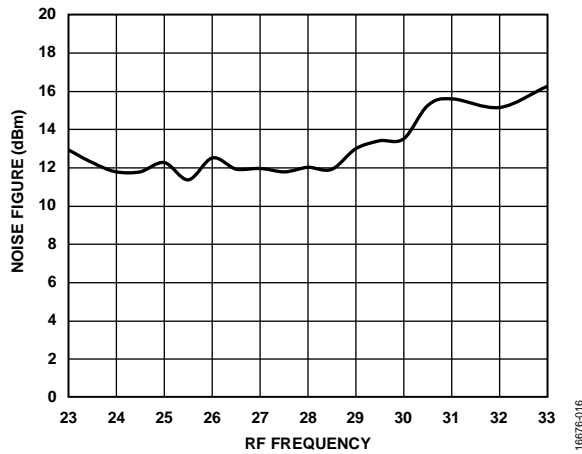

Figure 22. Noise Figure vs. RF Frequency at LO = 13 dBm, $T_A = 25^\circ\text{C}$

DOWNCONVERTER PERFORMANCE, IF = 8000 MHz

Upper Sideband (Low-Side LO)

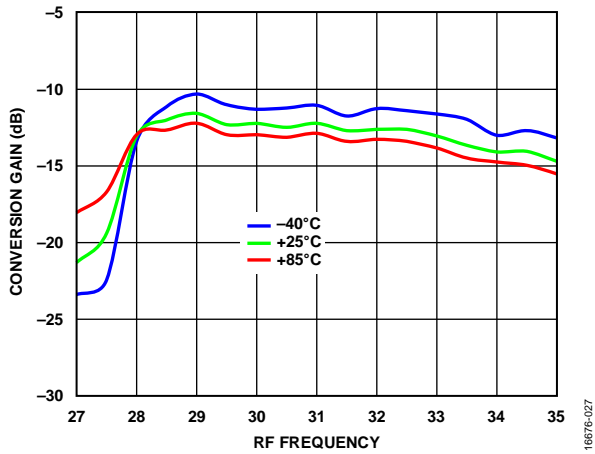

Figure 24. Conversion Gain vs. RF Frequency at Various Temperatures, LO = 13 dBm

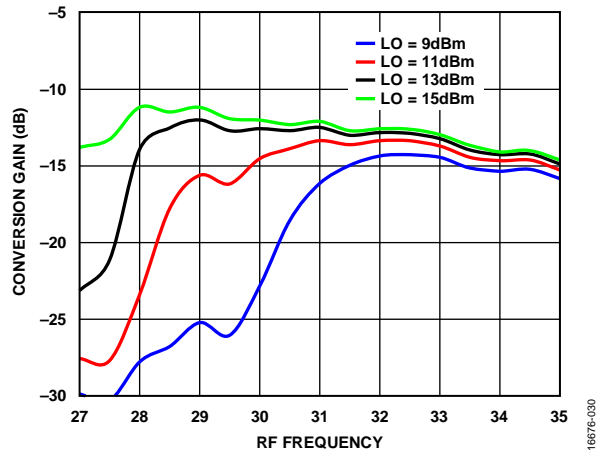

Figure 27. Conversion Gain vs. RF Frequency at Various LO Power Levels, TA = 25°C

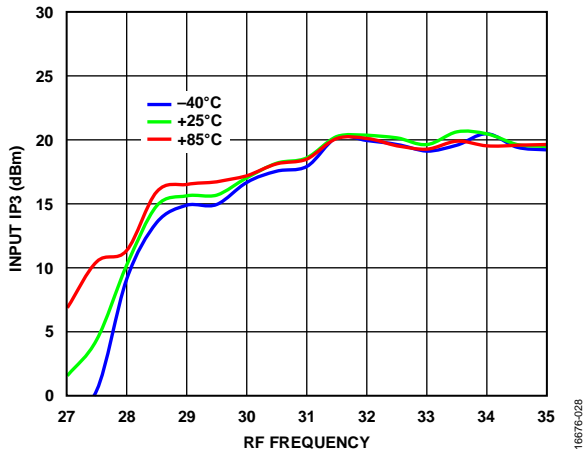

Figure 25. Input IP3 vs. RF Frequency at Various Temperatures, LO = 13 dBm

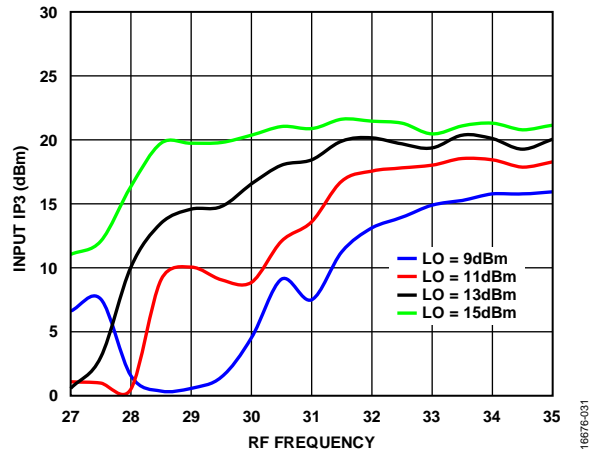

Figure 28. Input IP3 vs. RF Frequency at Various LO Power Levels, TA = 25°C

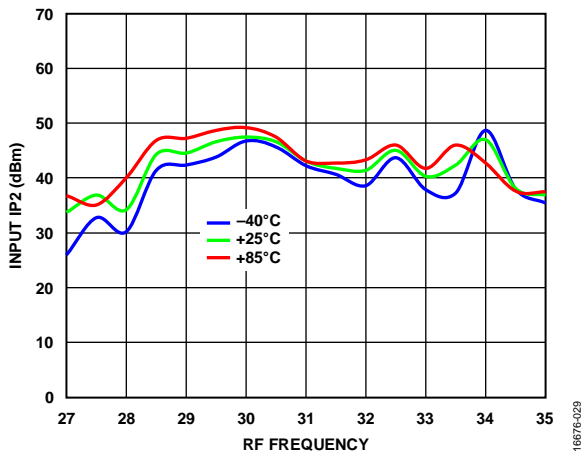

Figure 26. Input IP2 vs. RF Frequency at Various Temperatures, LO = 13 dBm

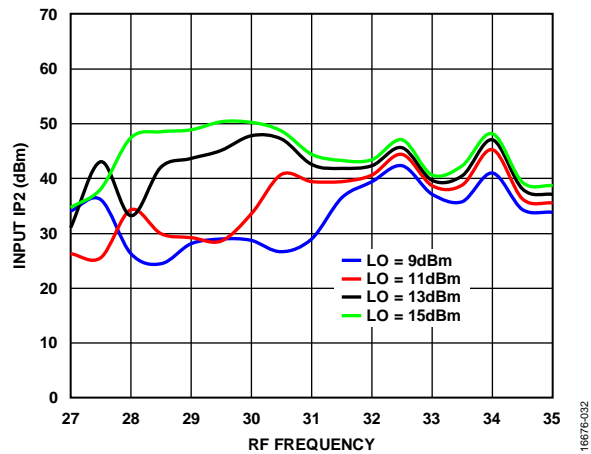

Figure 29. Input IP2 vs. RF Frequency at Various LO Power Levels, TA = 25°C

Lower Sideband (High-Side LO)

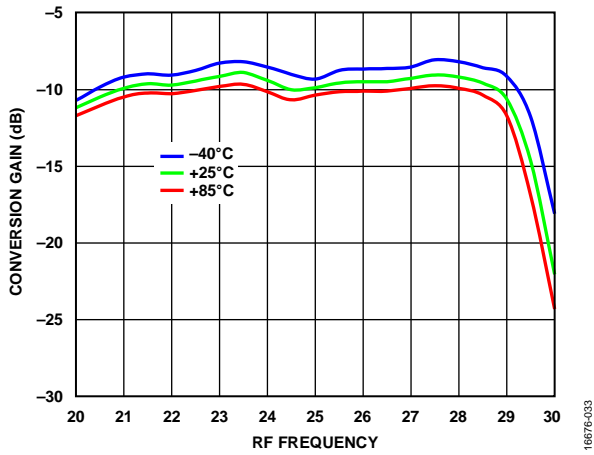

Figure 30. Conversion Gain vs. RF Frequency at Various Temperatures, LO = 13 dBm

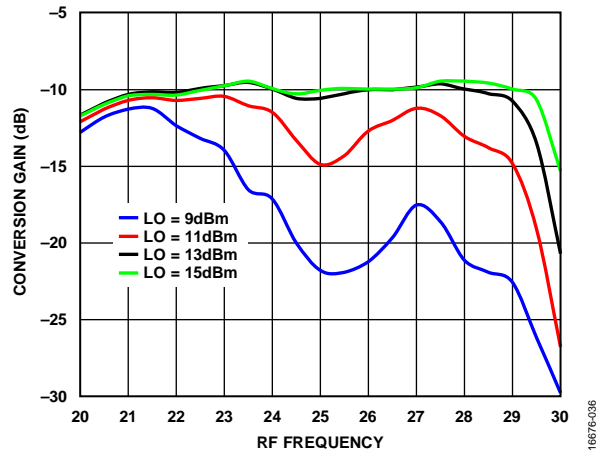

Figure 33. Conversion Gain vs. RF Frequency at Various LO Power Levels, TA = 25°C

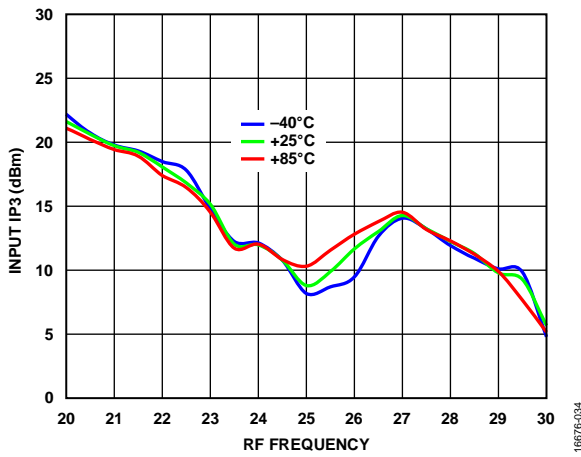

Figure 31. Input IP3 vs. RF Frequency at Various Temperatures, LO = 13 dBm

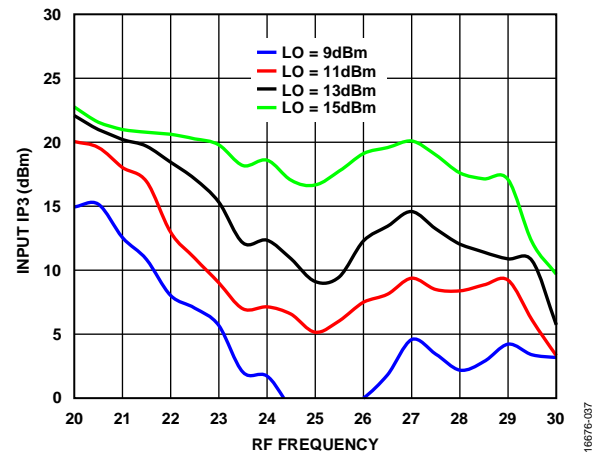

Figure 34. Input IP3 vs. RF Frequency at Various LO Power Levels, TA = 25°C

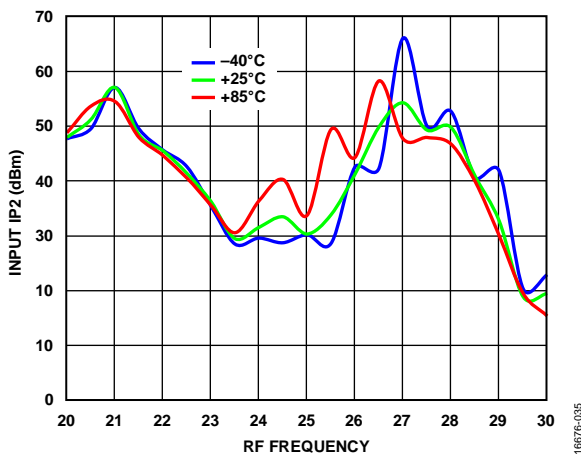

Figure 32. Input IP2 vs. RF Frequency at Various Temperatures, LO = 13 dBm

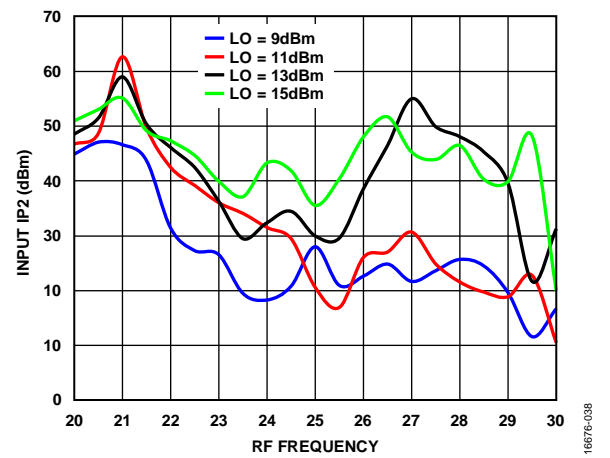

Figure 35. Input IP2 vs. RF Frequency at Various LO Power Levels, TA = 25°C

UPCONVERTER PERFORMANCE, IF = 1000 MHz
Upper Sideband (Low-Side LO)

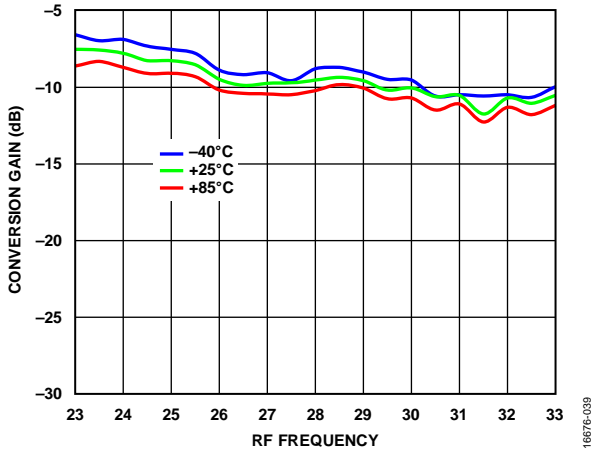

Figure 36. Conversion Gain vs. RF Frequency at Various Temperatures, LO = 13 dBm

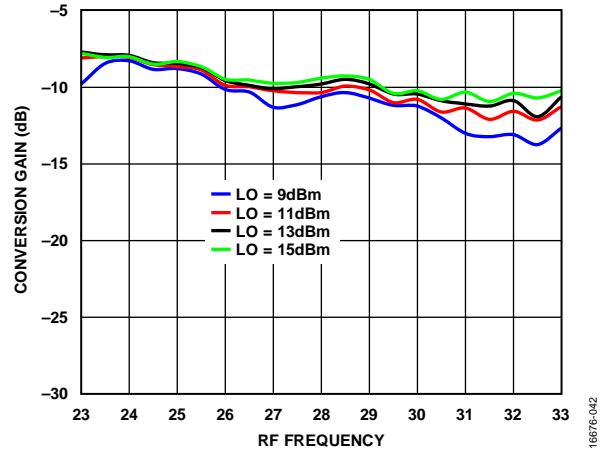

Figure 39. Conversion Gain vs. RF Frequency at Various LO Power Levels, $T_A = 25^\circ\text{C}$

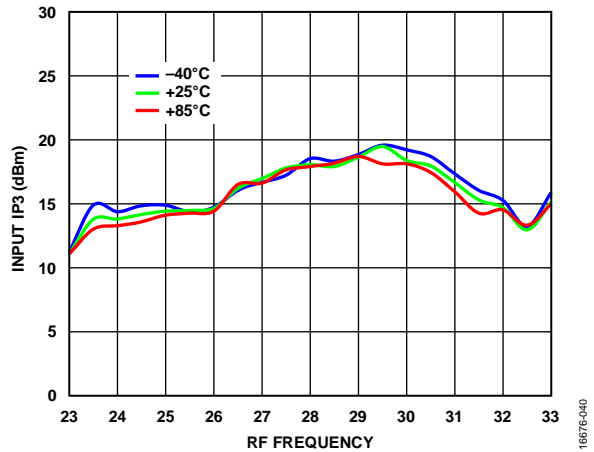

Figure 37. Input IP3 vs. RF Frequency at Various Temperatures, LO = 13 dBm

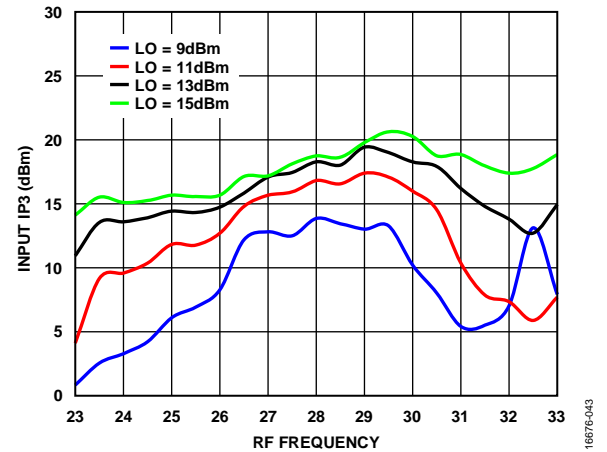

Figure 40. Input IP3 vs. RF Frequency at Various LO Power Levels, $T_A = 25^\circ\text{C}$

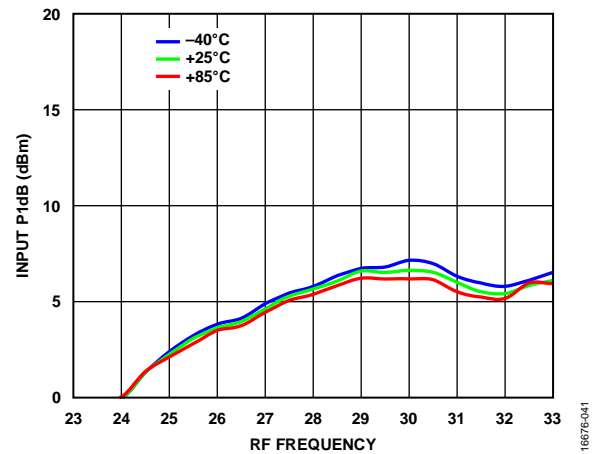

Figure 38. Input P1dB vs. RF Frequency at Various Temperatures, LO = 13 dBm

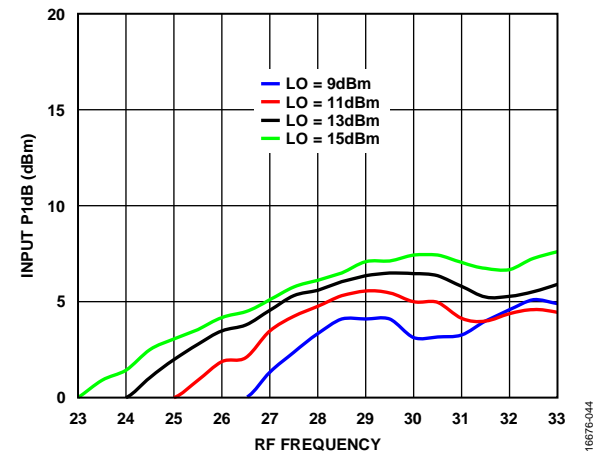

Figure 41. Input P1dB vs. RF Frequency at Various LO Power Levels, $T_A = 25^\circ\text{C}$

Lower Sideband (High-Side LO)

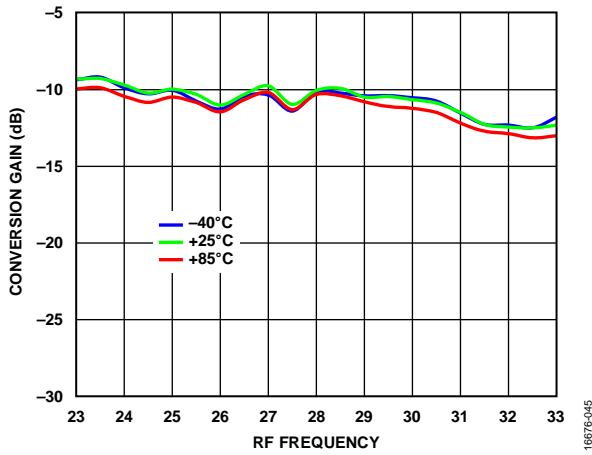

Figure 42. Conversion Gain vs. RF Frequency at Various Temperatures, LO = 13 dBm

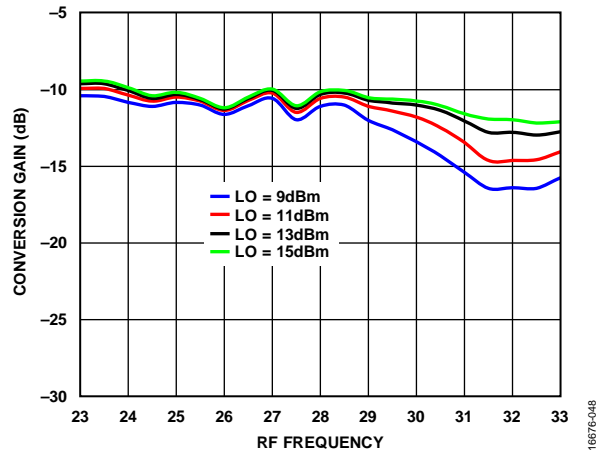

Figure 45. Conversion Gain vs. RF Frequency at Various LO Power Levels, TA = 25°C

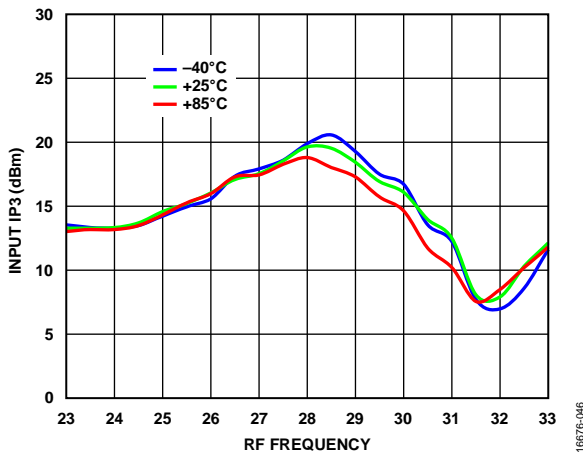

Figure 43. Input IP3 vs. RF Frequency at Various Temperatures, LO = 13 dBm

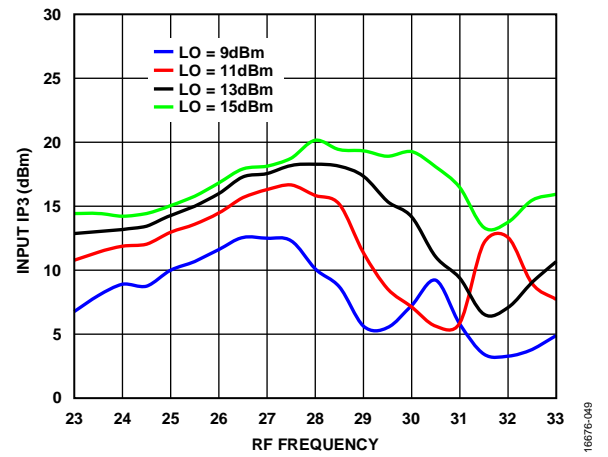

Figure 46. Input IP3 vs. RF Frequency at Various LO Power Levels, TA = 25°C

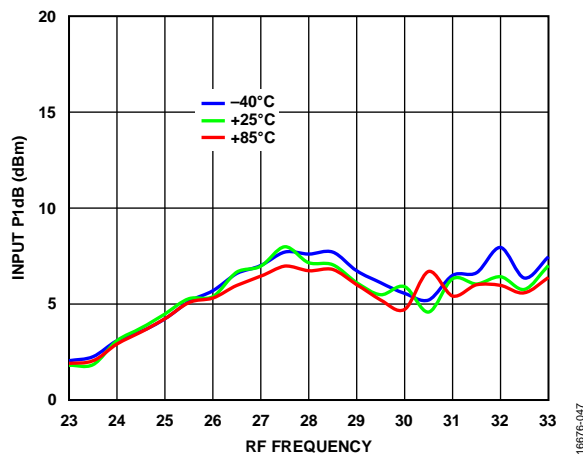

Figure 44. Input P1dB vs. RF Frequency at Various Temperatures, LO = 13 dBm

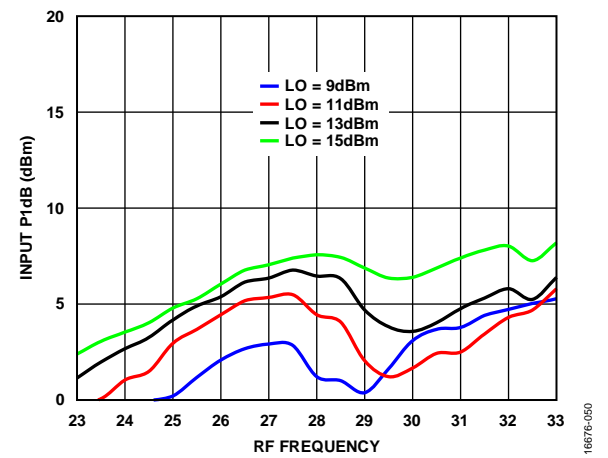

Figure 47. Input P1dB vs. RF Frequency at Various LO Power Levels, TA = 25°C

UPCONVERTER PERFORMANCE, IF = 8000 MHz
Upper Sideband (Low-Side LO)

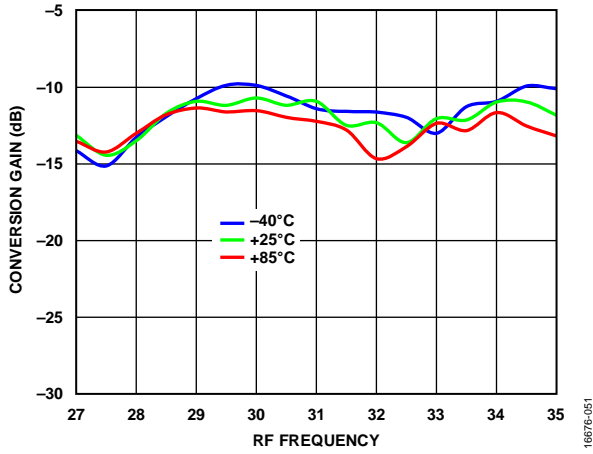

Figure 48. Conversion Gain vs. RF Frequency at Various Temperatures, LO = 13 dBm

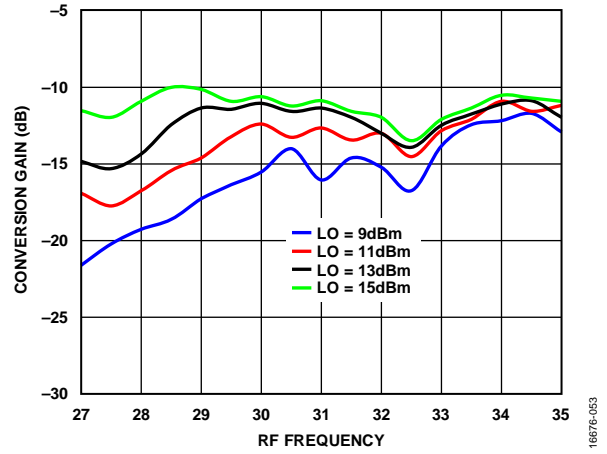

Figure 50. Conversion Gain vs. RF Frequency at Various LO Power Levels, $T_A = 25^\circ\text{C}$

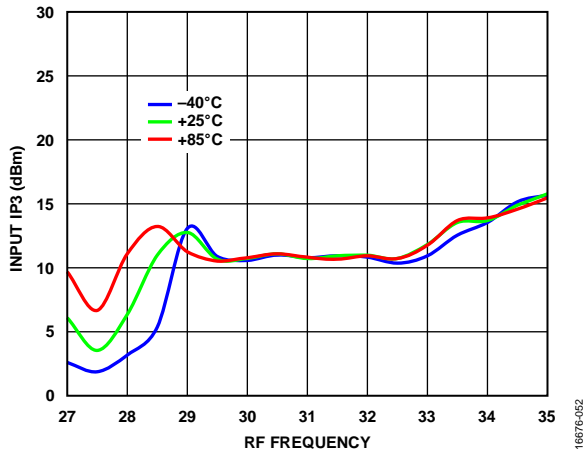

Figure 49. Input IP3 vs. RF Frequency at Various Temperatures, LO = 13 dBm

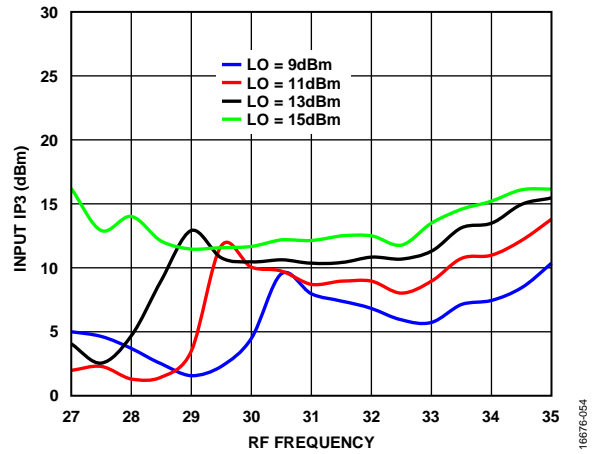

Figure 51. Input IP3 vs. RF Frequency at Various LO Power Levels, $T_A = 25^\circ\text{C}$

Lower Sideband (High-Side LO)

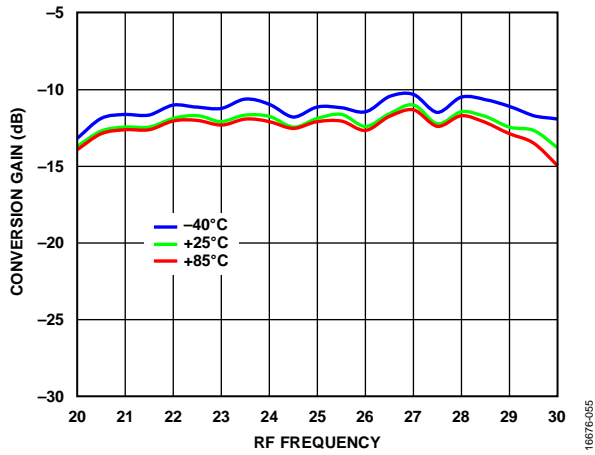

Figure 52. Conversion Gain vs. RF Frequency at Various Temperatures, LO = 13 dBm

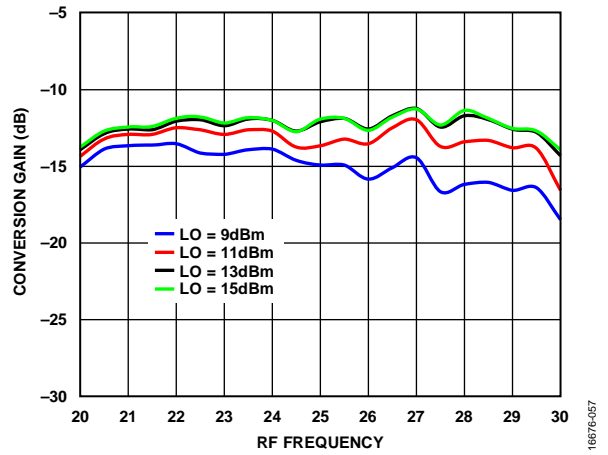

Figure 54. Conversion Gain vs. RF Frequency at Various LO Power Levels, $T_A = 25^\circ\text{C}$

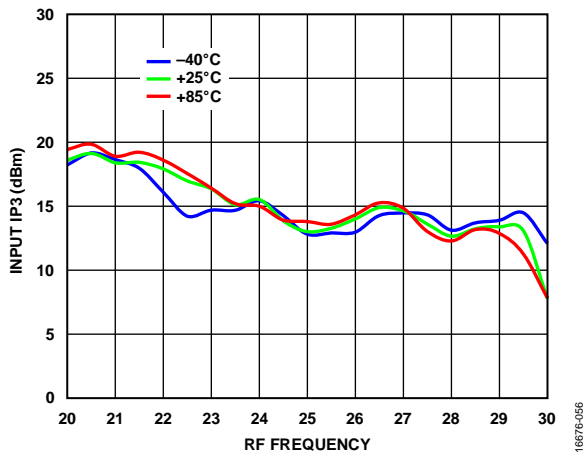

Figure 53. Input IP3 vs. RF Frequency at Various Temperatures, LO = 13 dBm

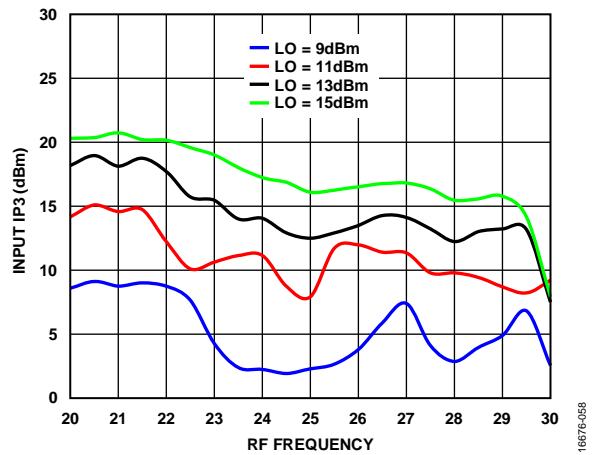

Figure 55. Input IP3 vs. RF Frequency at Various LO Power Levels, $T_A = 25^\circ\text{C}$

Isolation and Return Loss

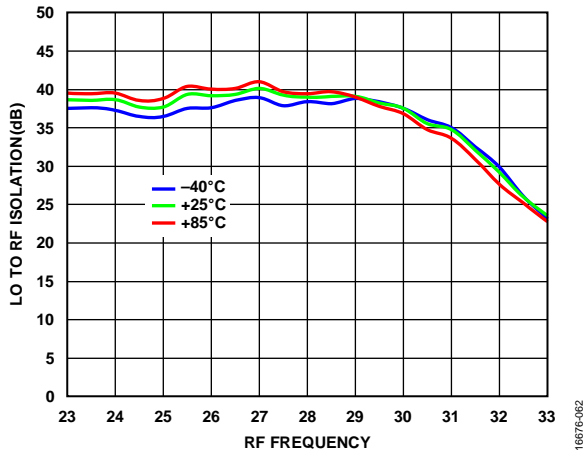

Figure 56. LO to RF Isolation vs. RF Frequency at Various Temperatures, LO = 13 dBm

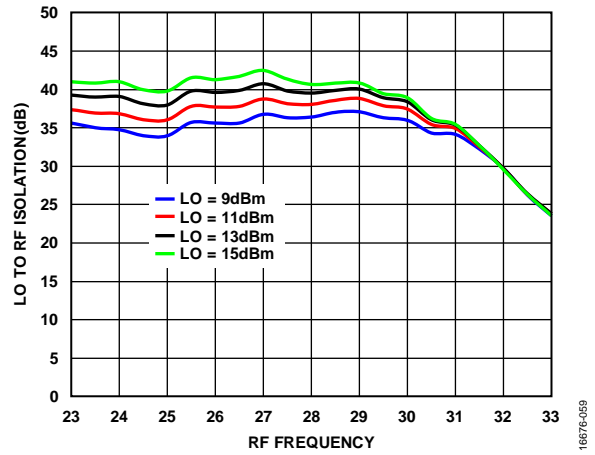

Figure 59. LO to RF Isolation vs. RF Frequency at Various LO Power Levels, TA = 25°C

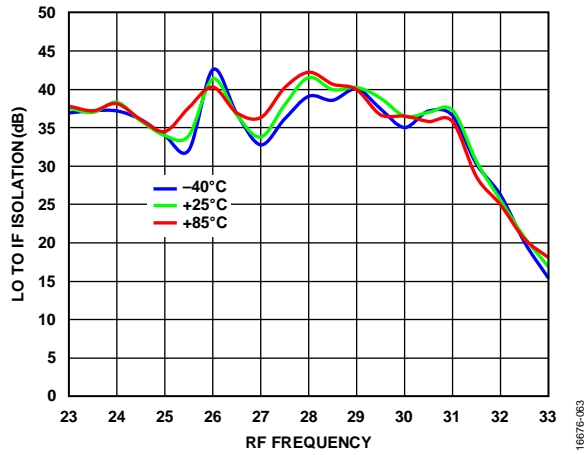

Figure 57. LO to IF Isolation vs. RF Frequency at Various Temperatures, LO = 13 dBm

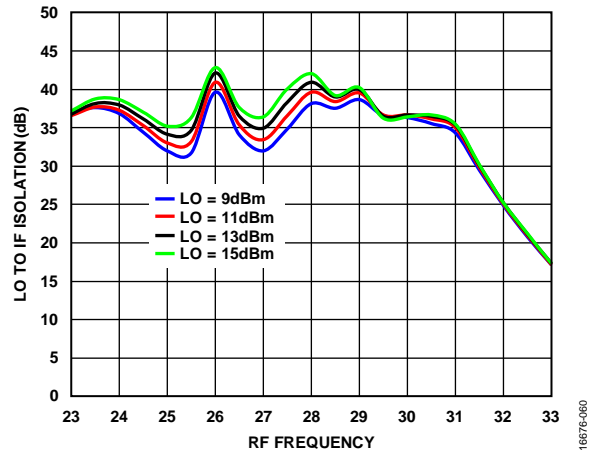

Figure 60. LO to IF Isolation vs. RF Frequency at Various LO Power Levels, TA = 25°C

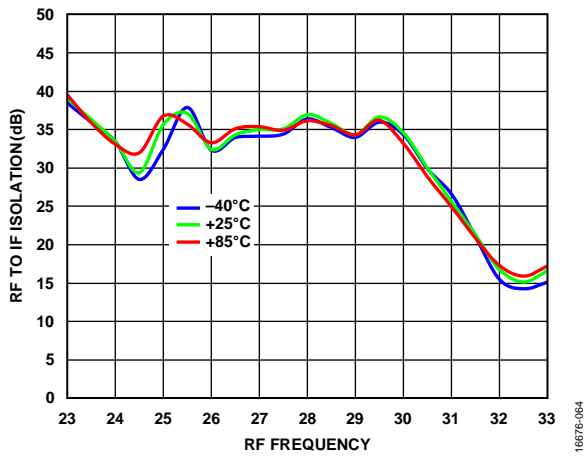

Figure 58. RF to IF Isolation vs. RF Frequency at Various Temperatures, LO = 13 dBm

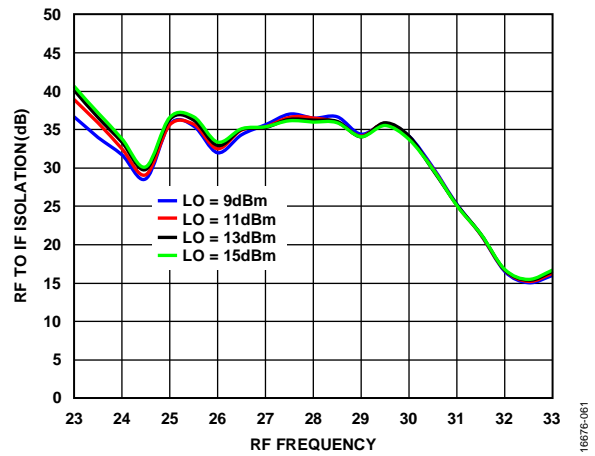

Figure 61. RF to IF Isolation vs. RF Frequency at Various LO Power Levels, TA = 25°C

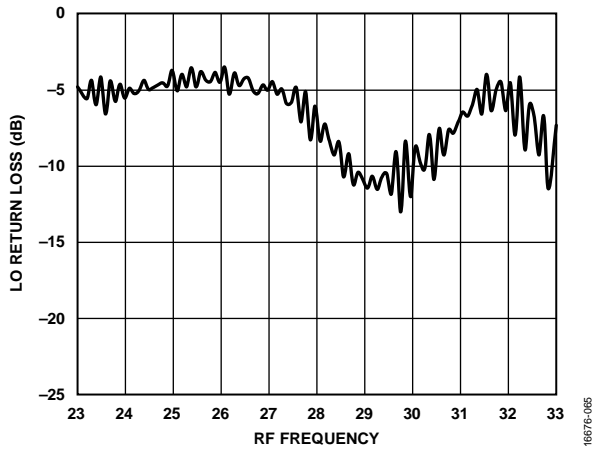

Figure 62. LO Return Loss vs. RF Frequency at LO = 13 dBm, $T_A = 25^\circ\text{C}$

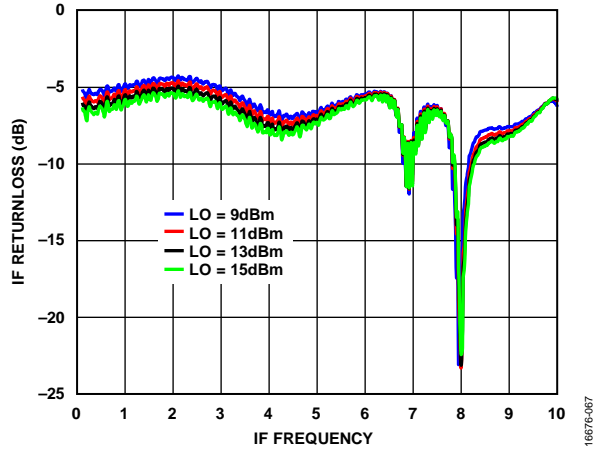

Figure 64. IF Return Loss vs. IF Frequency at Various LO Power Levels, $T_A = 25^\circ\text{C}$, LO = 27 GHz

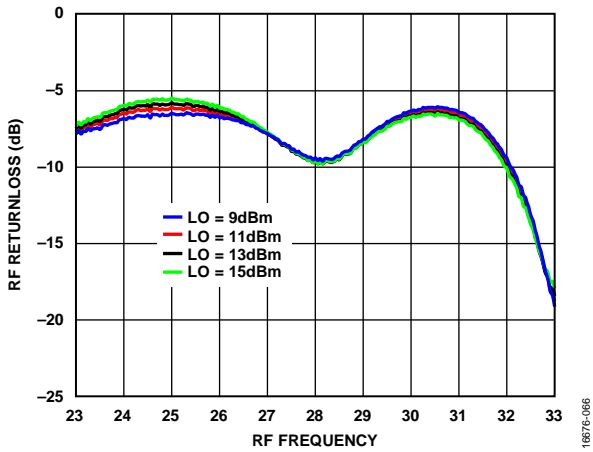

Figure 63. RF Return Loss vs. RF Frequency at Various LO Power Levels, $T_A = 25^\circ\text{C}$, LO = 27 GHz

IF BANDWIDTH—DOWNCONVERTER

Upper Sideband, LO Frequency = 25 GHz

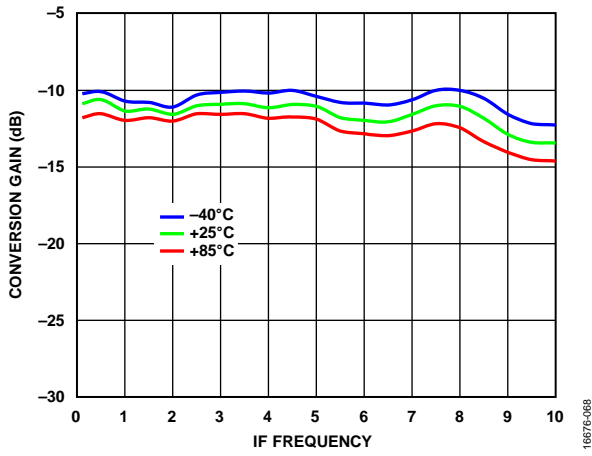

Figure 65. Conversion Gain vs. IF Frequency at Various Temperatures, LO = 13 dBm

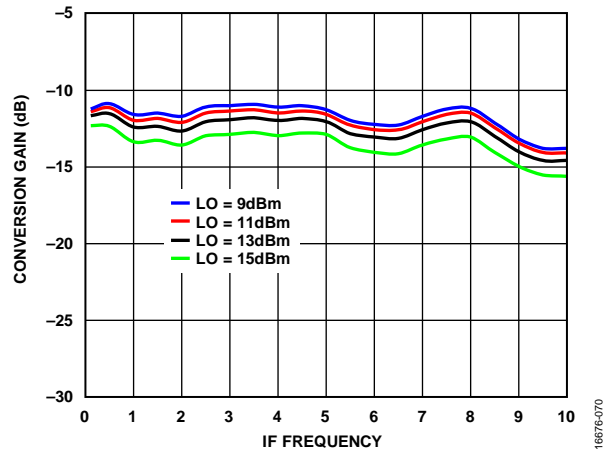

Figure 67. Conversion Gain vs. IF Frequency at Various LO Power Levels, $T_A = 25^\circ\text{C}$

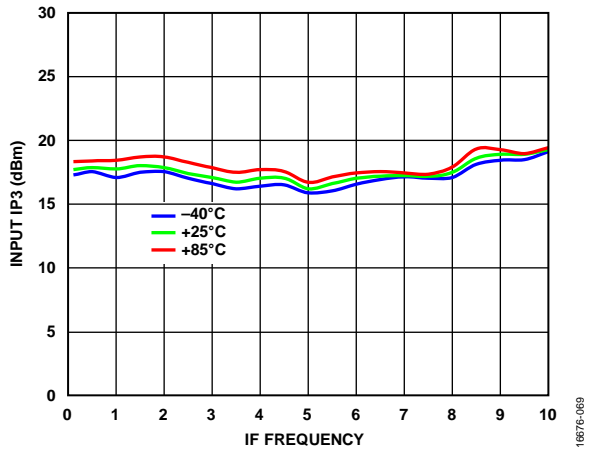

Figure 66. Input IP3 vs. IF Frequency at Various Temperatures, LO = 13 dBm

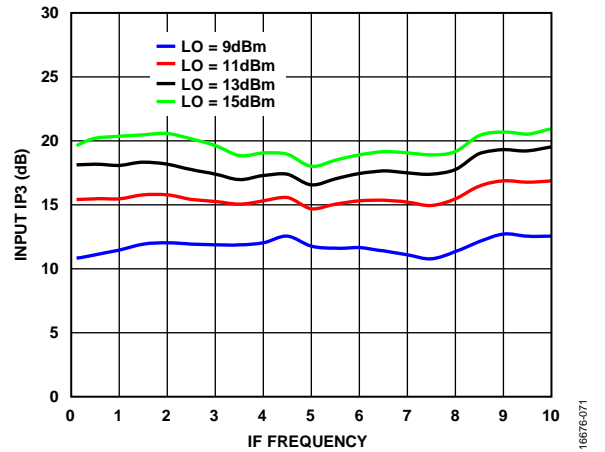

Figure 68. Input IP3 vs. IF Frequency at Various LO Power Levels, $T_A = 25^\circ\text{C}$

Lower Sideband, LO Frequency = 31 GHz

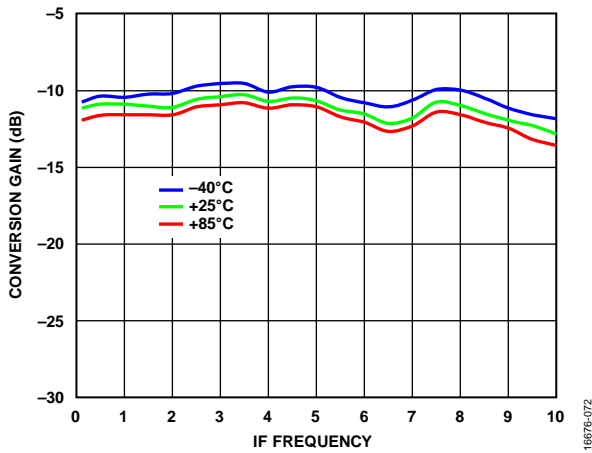

Figure 69. Conversion Gain vs. IF Frequency at Various Temperatures, LO = 13 dBm

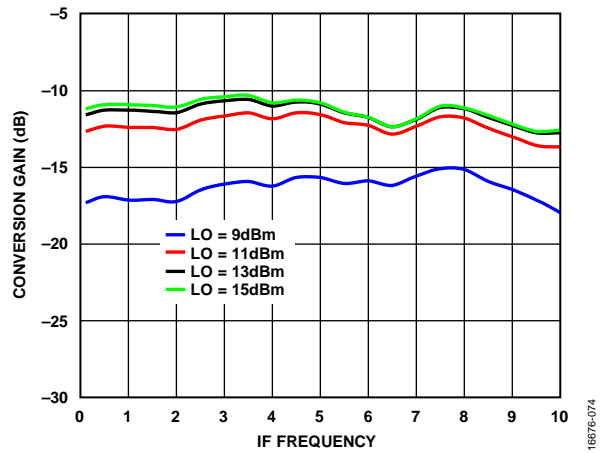

Figure 71. Conversion Gain vs. IF Frequency at Various LO Power Levels, $T_A = 25^\circ\text{C}$

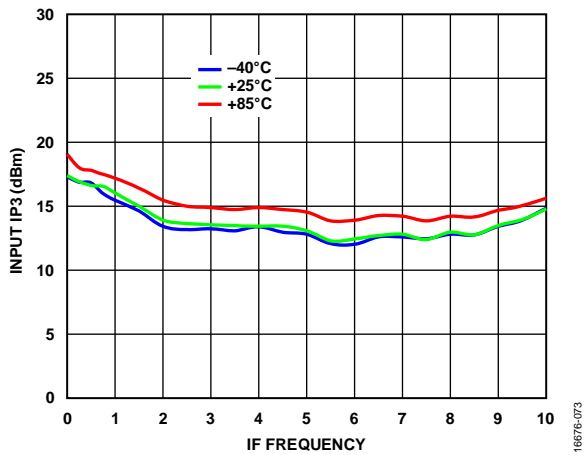

Figure 70. Input IP3 vs. IF Frequency at Various Temperatures, LO = 13 dBm

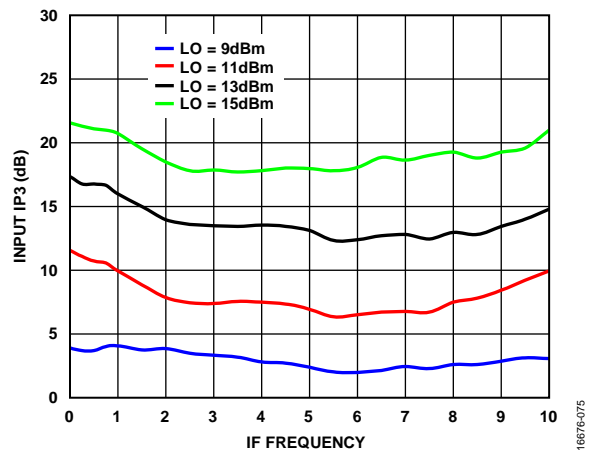

Figure 72. Input IP3 vs. IF Frequency at Various LO Power Levels, $T_A = 25^\circ\text{C}$

SPURIOUS AND HARMONICS PERFORMANCE

Mixer spurious products are measured in dBc from the IF output power level. N/A means not applicable.

LO Harmonics

LO = 13 dBm, all values in dBc are below input LO level and are measured at the RF port.

Table 5. LO Harmonics at RF

LO Frequency (GHz)	N × LO Spur at RF Port			
	1	2	3	4
22	43	69	N/A	N/A
25	42	75	N/A	N/A
28	45	N/A	N/A	N/A
30	37	N/A	N/A	N/A
33	30	N/A	N/A	N/A
35	37	N/A	N/A	N/A
38	28	N/A	N/A	N/A

LO = 13 dBm, all values in dBc are below input LO level and are measured at the IF port.

Table 6. LO Harmonics at IF

LO Frequency (GHz)	N × LO Spur at IF Port			
	1	2	3	4
22	41	99	N/A	N/A
25	43	78	N/A	N/A
28	43	N/A	N/A	N/A
30	34	N/A	N/A	N/A
33	36	N/A	N/A	N/A
35	39	N/A	N/A	N/A
38	31	N/A	N/A	N/A

M × N Spurious Outputs

Downconverter, Upper Sideband

Spur values are (M × RF) – (N × LO). RF = 28 GHz at –10 dBm, LO = 27 GHz at 13 dBm.

		N × LO					
		0	1	2	3	4	5
M × RF	0	N/A	7	N/A	N/A	N/A	N/A
	1	27	N/A	36	N/A	N/A	N/A
	2	N/A	66	57	69	N/A	N/A
	3	N/A	N/A	72	81	72	N/A
	4	N/A	N/A	N/A	73	78	72
	5	N/A	N/A	N/A	N/A	71	78

Upconverter, Upper Sideband

Spur values are (M × IF) + (N × LO). IF_{IN} = 1000 MHz at –10 dBm, LO = 27 GHz at 13 dBm.

		N × LO			
		0	1	2	3
M × IF	–5	80	70	N/A	N/A
	–4	79	71	N/A	N/A
	–3	74	61	N/A	N/A
	–2	55	41	N/A	N/A
	–1	20	0	N/A	N/A
	0	N/A	6	N/A	N/A
	+1	20	0	N/A	N/A
	+2	55	39	N/A	N/A
	+3	72	58	N/A	N/A
	+4	79	75	58	N/A
	+5	80	74	58	N/A

THEORY OF OPERATION

The HMC329ALC3B is a general-purpose, double balanced mixer that can be used as an upconverter or a downconverter from 24 GHz to 32 GHz.

When used as a downconverter, the HMC329ALC3B downconverts radio frequencies between 24 GHz and 32 GHz to intermediate frequencies between dc and 8 GHz.

When used as an upconverter, the mixer upconverts intermediate frequencies between dc and 8 GHz to radio frequencies between 24 GHz and 32 GHz.

APPLICATIONS INFORMATION

TYPICAL APPLICATION CIRCUIT

Figure 73 shows the typical application circuit for the HMC329ALC3B. The HMC329ALC3B is a passive device and does not require any external components. The LO and RF pins are internally ac-coupled. The IF pin is internally dc-coupled. For applications not requiring operation to dc, dc block this port externally using a series capacitor of a value chosen to pass the necessary IF frequency range. When IF operation to dc is required, do not exceed the IF source and sink current rating specified in the Absolute Maximum Ratings section.

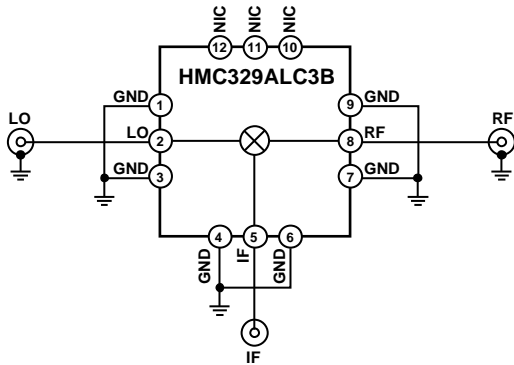

Figure 73. Typical Application Circuit

EVALUATION PCB INFORMATION

Use RF circuit design techniques for the circuit board used in the application. Ensure that signal lines have 50 Ω impedance and connect the package ground leads and the exposed pad directly to the ground plane (see Figure 74). Use a sufficient number of via holes to connect the top and bottom ground planes. The evaluation circuit board shown in Figure 74 is available from Analog Devices, Inc., upon request.

Table 7. List of Materials for Evaluation PCB
EV1HMC329ALC3B

Item	Description
J1, J2	PCB mount, SRI, 2.92 mm connectors
J3	PCB mount, Johnson Components SMA connector
U1	HMC329ALC3B
PCB ¹	117611-1 evaluation board on Rogers Corporation RO4350B laminates

¹ 117611-1 is the raw bare PCB identifier. Reference EV1HMC329ALC3B when ordering complete evaluation PCB.

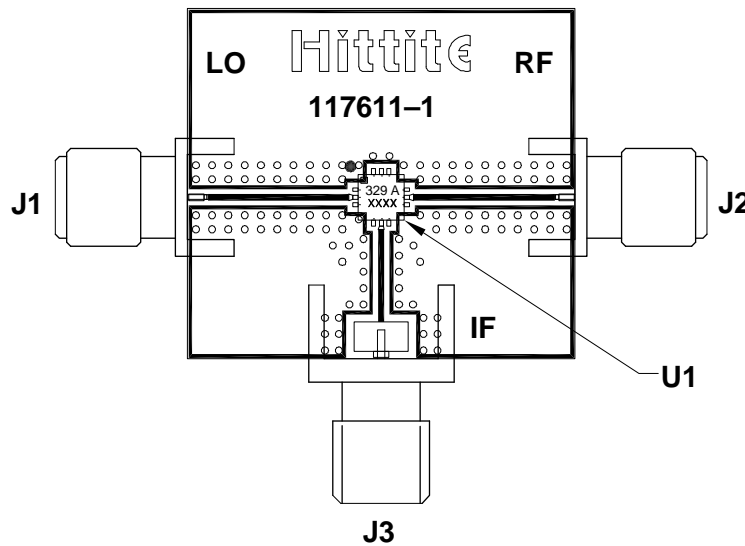

Figure 74. Evaluation PCB Top Layer

OUTLINE DIMENSIONS

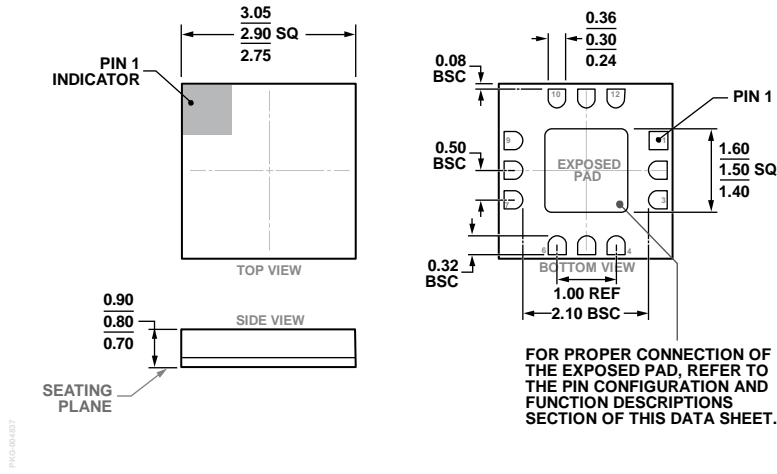

Figure 75. 12-Terminal Ceramic Leadless Chip Carrier [LCC]
(E-12-4)
Dimensions shown in millimeters

ORDERING GUIDE

Model ¹	Temperature Range	Moisture Sensitivity Level (MSL) Rating ²	Package Description	Package Option
HMC329ALC3B	-40°C to +85°C	MSL3	12-Terminal LCC	E-12-4
HMC329ALC3BTR	-40°C to +85°C	MSL3	12-Terminal LCC	E-12-4
HMC329ALC3BTR-R5	-40°C to +85°C	MSL3	12-Terminal LCC	E-12-4
EV1HMC329ALC3B			Evaluation PCB Assembly	

¹ The HMC554ALC3B, HMC554ALC3BTR, and HMC554ALC3BTR-R5 are RoHS compliant parts.
² See Table 2 in the Absolute Maximum Ratings section.